



20W 0-10V 'Dim to Dark' LED Driver

SOLOdrive

SOLOdrive offers industry-best Natural Dimming to dark - LED dimming made beautiful! With any dimmer, in any application. Symbiosis on SOLOdrive stands for unity, for the SOLOdrive working seamlessly together with LED modules, controls and intelligent luminaire elements.

Product offering



SOLOdrive 241/A-BIS

Part number (P/N)	SL0241A2-BIS
Product description	SOLOdrive AC, 20W, 0-10V, 1 control channel, constant current, 1x 40V output, side feed, long plastic

Features & benefits

Natural dimming	Dim to dark, smooth brightness changes, excellent flicker performance, adaptable dimming curves, configurable minimum dimming level
Symbiosis	Seamless interoperability with LED modules, controls and in-luminaire intelligent devices
LEDcode	Configurable design to work with most constant current LED modules and arrays, while providing a connection point to integrated peripheral controls
Programmable	Fine-tune your driver for any application
Performance	Low inrush current and total harmonic distortion (THD), high power factor and efficiency
Camera compatibility	Hybrid HydraDrive technology is proven to work in TV studios and security camera environments

Programming tools

Programming interface	TOOLbox pro (TLU20504)
Programming cable set	TOOLbox pro to LED driver, programming cable, 5pcs (TLC03051)
Programming Hand-held, Touch-and-Go	PJ0035HH1
Programming jig	PJ0200A1
Programming software	FluxTool

Warranty

Warranty period	General Terms and Conditions
-----------------	--

Order number configurator

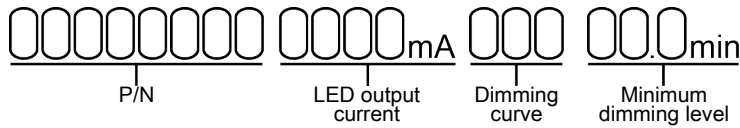

P/N	LED driver part number.
LED output current	Enter value in 1mA increments, e.g. "811" for 811mA
Dimming curve	"LOG" for logarithmic (default) "LIN" for linear "SLN" for soft-linear "SQU" for square
Minimum dimming level	Leave blank for default minimum dimming level of 0.1%. Specify in 0.1% increments, e.g. "10.5" for 10.5%.

Input characteristics

Nominal input voltage range AC	220 - 240V
Absolute input voltage range AC	198 - 264V
Nominal input voltage range DC	176 - 250V
Maximum input current	0.15A @ 230V / 50Hz
Input frequency range	50Hz
Efficiency at full load	80%
Power factor at full load	> 0.95
THD at full load	< 20%
Maximum inrush current	< 200mA ² s @ 230V / 50Hz
Surge protection	2kV differential mode (DM) 2kV common mode (CM)
Maximum standby power	<0.5W

Output characteristics

Maximum LED output power	20W
Number of LED outputs	1
Programmable LED output current range	150 - 1050mA
LED output type	Programmable in 1mA increments within specified current range
LED output current tolerance	+/- 5% at programmed LED output current
LED output voltage range	2 - 40V

Operating window

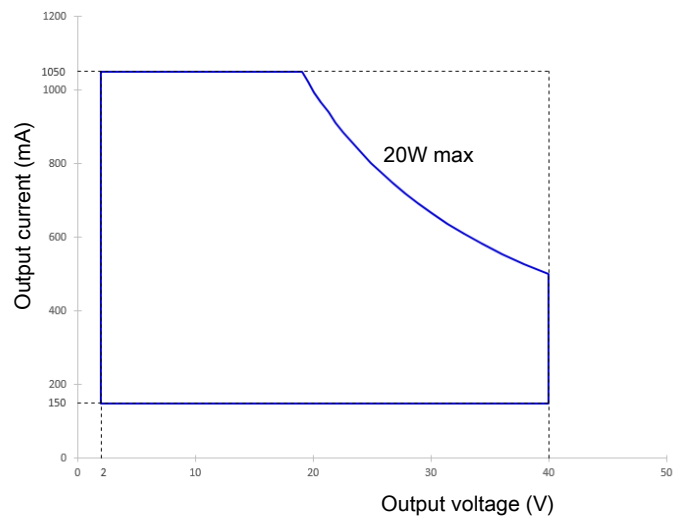

Control characteristics

Control channels	1
Control protocol	0-10V LEDcode
Dimming range	100% - 0.1%
Dimming curve options	Logarithmic (default) Linear Soft-Linear Square
Dimming method	Hybrid HydraDrive
0-10V current draw	0.6mA
Time delay to standby	<60s

0-10V dimming chart

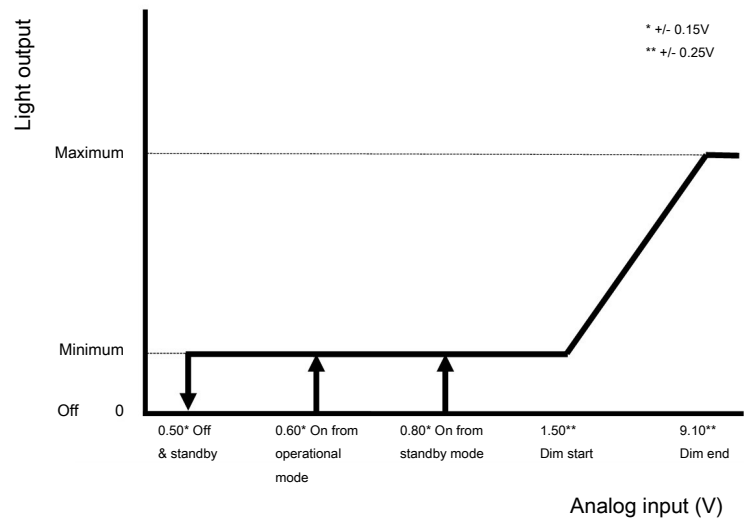

Dimming curves

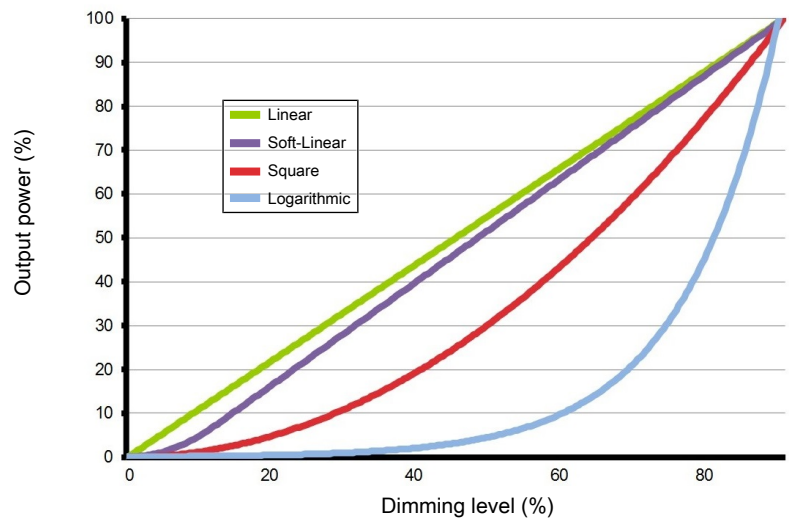

Performance

Typical efficiency vs load

Tested with a load of 12 LEDs in series, programmed for 500mA and at 25 °C ambient temperature. The measurements below 20W were performed by dimming the light output.

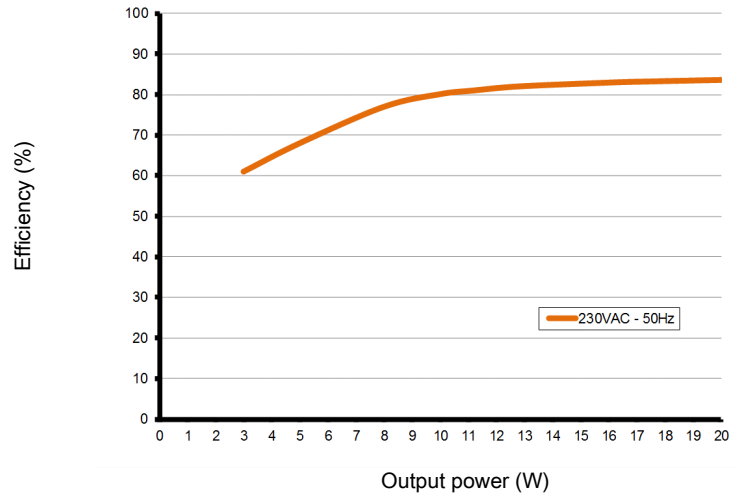

Typical power factor vs load

Tested with a load of 12 LEDs in series, programmed for 500mA and at 25 °C ambient temperature. The measurements below 20W were performed by dimming the light output.

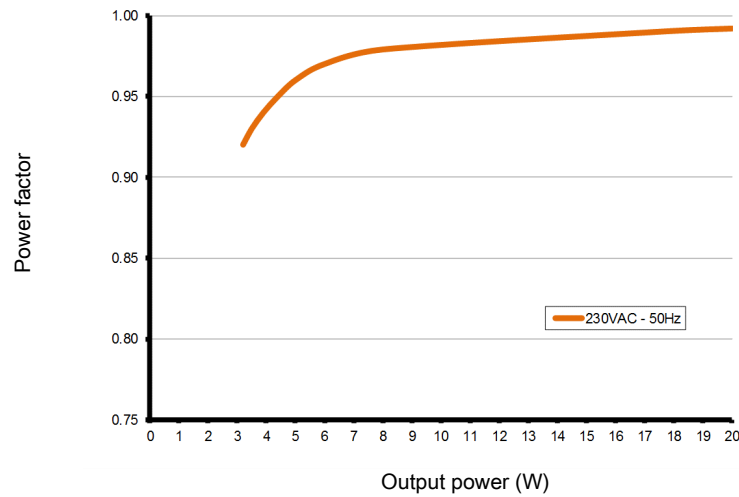

Typical THD vs load

Tested with a load of 12 LEDs in series, programmed for 500mA and at 25 °C ambient temperature. The measurements below 20W were performed by dimming the light output.

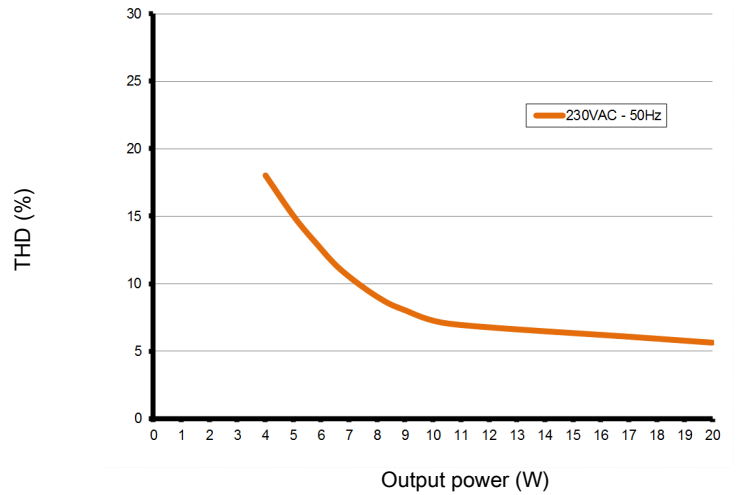

Typical flicker performance

Typical flicker percent as a function of frequency, measured across the dimming range. The results are overlaid with the low-risk (yellow) and no observable effect (green) levels as defined in IEEE P1789.

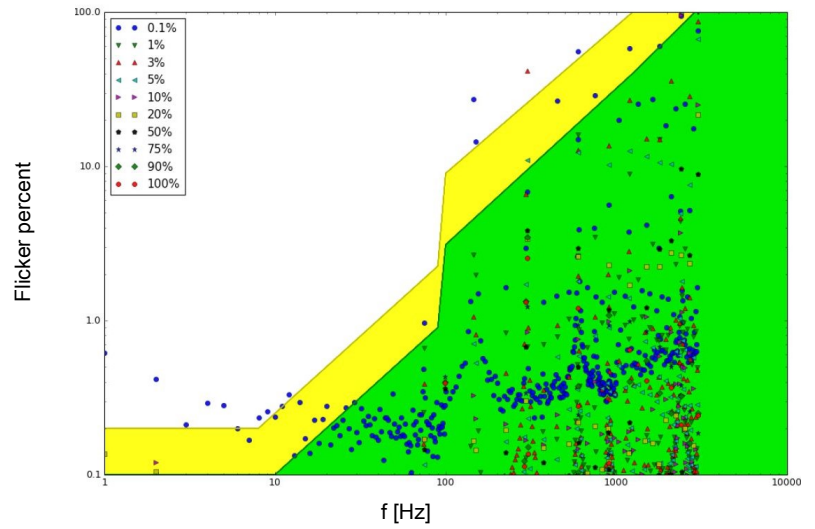

Environmental conditions

Operating ambient temperature (T_a) range -20 °C to +50 °C
 for output current \leq 900mA
 -20 °C to +43 °C for output current >900mA

Maximum operating case temperature (T_c max) 80 °C

Lifetime 50000 hours at a maximum case temperature (T_c) of 80 °C

TC point location

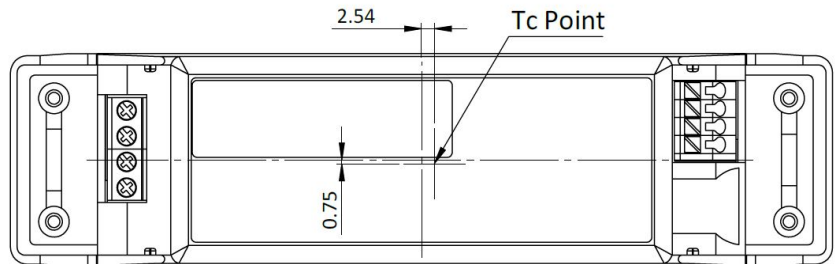

LED driver protection

Thermal	The LED output current is decreased whenever the internal LED driver temperature exceeds factory preset temperature. The LED output current is increased again once the internal LED driver temperature drops below this internal temperature threshold. If the internal LED driver temperature continues to increase, despite a decrease in output current, the LED driver will shut down.
LED output short circuit	The LED output current is cut off whenever the LED driver detects a short-circuit. The LED driver will attempt a restart every 400ms after a short-circuit is detected.
LED output overload	The LED driver decreases the LED output current sequentially, until it reaches its maximum rated power, whenever a load that exceeds the LED driver's maximum rated power is connected to the LED output.
Reverse polarity	The LED driver will not yield any current if the polarity of the load on the LED output is reversed. This situation will not damage the LED driver but may damage the LED load.

LED protection

Thermal protection LED	An external NTC thermistor, which is placed on a PCB near the LEDs, can be connected to the driver via the LEDcode/NTC terminals. The output current to the LEDs is then decreased by 75% whenever the NTC exceeds a maximum allowable temperature, which is specified by the user in the FluxTool software. The default NTC temperature limit is set to 70 °C.
Thermistor value	47kΩ
Suitable thermistors	Leaded: Vishay, P/N 238164063473 Screw: Vishay, P/N NTCASCWE3473J

LED driver mechanical details

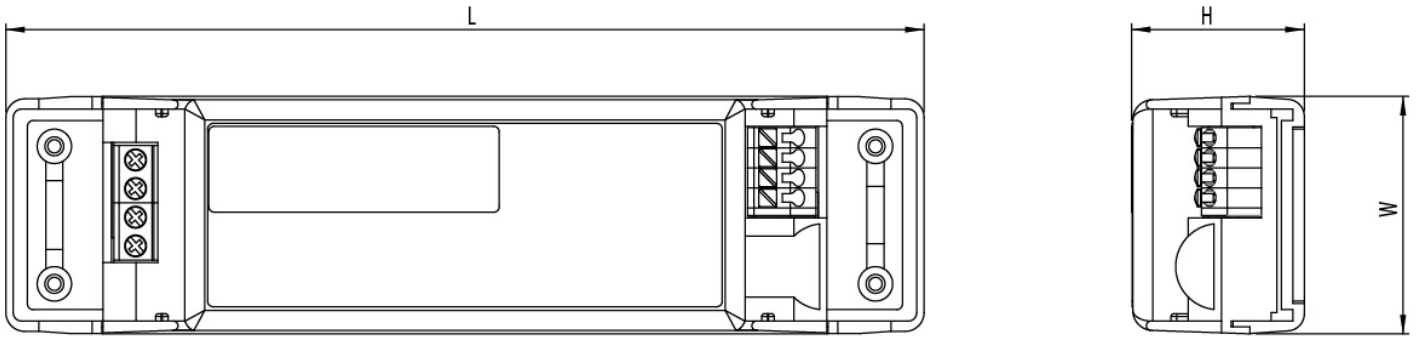

Length (L)	typical: 160 mm / 6.3 in maximum: 160.5 mm / 6.32 in
Width (W)	typical: 41.5 mm / 1.63 in maximum: 42 mm / 1.65 in
Height (H)	typical: 30.5 mm / 1.2 in maximum: 31 mm / 1.22 in
3D files available on product web page	IGS STEP
Weight	125 g
Mounting torque	Not to exceed 0.5Nm

Packaging

Length x Width x Height	550 x 200 x 200 mm / 21.7 x 7.9 x 7.9 in
Weight (including products)	6.75 kg
Products per box	50 pcs

Connector layout



Input wiring specifications

Connector type	screw terminals
Connector supplier and series	TE-Connectivity 2-796683
Wire type	solid or stranded copper
Wire core cross section	0.5 - 3 mm ² AWG 20 - 12
Wire strip length	9.0 mm
Input-cable shape	Round

Output wiring specifications

Connector type	push-in terminals
Connector supplier and series	Wago 250 series
Wire type	solid or stranded copper
Wire core cross section	0.5 - 1.5 mm ² AWG 20 – 16
Wire strip length	9.0 mm
Output-cable shape	Round
Maximum remote mounting distance of LED load	For independent use: 2 m / 6.5 ft For in-fixture use: AWG 20 (0.52 mm ²) - 14 m / 46 ft AWG 19 (0.65 mm ²) - 18 m / 59 ft AWG 18 (0.82 mm ²) - 22 m / 72 ft AWG 17 (1.04 mm ²) - 28 m / 92 ft AWG 16 (1.31 mm ²) - 36 m / 118 ft

Automatic circuit breakers (MCB)

Maximum loading	MCB type	B10	B13	B16	C10	C13	C16
	Number of LED drivers	66	86	106	66	86	106

Standards and compliance

ENEC safety	EN 61347-1
ENEC performance	EN 62384
Conducted emissions	EN 55015
Radiated emissions	EN 55015
Radio disturbance characteristics	EN 55022
Harmonic current emissions	EN 61000-3-2
Electrostatic discharge	EN 61000-4-2
RFE field susceptibility	EN 61000-4-3
Electrical fast transient	EN 61000-4-4
Surge immunity	EN 61000-4-5
Conducted radio frequency	EN 61000-4-6
Voltage dips	EN 61000-4-11
Electromagnetic immunity	EN 61547
0-10V	IEC/EN 60929 annex E NOTE: From 0.6V to 10V eldoLED LED drivers comply with IEC/EN 60929 annex E. Below 0.6V eldoLED LED drivers comply with ABL 0-10V Design Spec v1.2 enabling standby mode. For detailed dimming characteristics see 0-10V response chart in Control Characteristics.
BIS	Compulsory Registration Scheme for Electronic and IT Products given in Circular No. Ref: CMD 3/8: 1/6975 dated 03/12/2015. Registration number: R-41136530.
TISI	TIS 1955-2551 (2008)
Restriction of hazardous substances	RoHS3 (Directives 2011/65/EU-2015/863/EU)
SVHC-list substances	REACH Art.33

Certifications

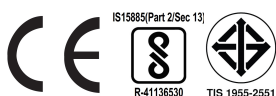

Safety



Risk of electrical shock. May result in serious injury or death. Disconnect power before servicing or installing.



The LED driver may only be connected and installed by a qualified electrician. All applicable regulations, legislation, and building codes must be observed. Incorrect installation of the LED driver can cause irreparable damage to the LED driver and the connected LEDs.

Pay attention when connecting the LEDs: polarity reversal results in no light output and often damages the LEDs.



LED drivers are designed and intended to operate LED loads only. Powering non-LED loads may push the LED driver outside its specified design limits and is, therefore, not covered by any warranty.



eldoLED products are designed to meet the performance specifications as outlined at certain operating conditions in the data sheet. It is the responsibility of the fixture manufacturer to test and validate the design and operation of the system under expected and potential use cases, including faults.



Please observe voltage drop over long cable lengths. Longer cable lengths increase EMI susceptibility.



Product renderings and dimensional drawings are generic for the housing type. Product label, connector type and quantity may vary.

Europe, Rest of World

eldoLED B.V.
Science Park Eindhoven 5125
5692 ED Son
The Netherlands

E: info@eldoled.com
W: www.eldoled.com

North America

eldoLED America
One Lithonia Way
Conyers, GA 30012
USA

E: info@eldoled.com
W: www.eldoled.com
