

optris® CSmicro LT

Low cost micro size infrared thermometer
for -40°C to 1030°C



Features

- Size: M12x1, 28 mm long, stainless steel housing
- Temperature range: -40°C to 1030°C
- Rugged coated silicon optics
- Usable up to 120°C ambient temperature without cooling (sensing head)
- Green LED alarm indication, aiming support, self diagnostic or temperature code indication
- Cable built in electronics
- Scalable analog output: 0-10 V or 0-5 V and additional simultaneous alarm output
- Short circuit and polarity reversal protection
- Adjustable signal processing
- Optional USB programming interface and software
- Wide power range: 5-30 V DC

General Specifications

Environmental rating	IP 65 (NEMA-4)
Ambient temperature	-20°C to 120°C (sensing head) -20°C to 80°C (electronics)
Storage temperature	-40°C to 85°C (sensing head and electronics)
Relative humidity	10 - 95%, non condensing
Vibration	IEC 68-2-6: 3 G, 11-200 Hz, any axis
Shock	IEC 68-2-27: 50 G, 11 ms, any axis
Weight	42 g

Electrical Specifications

Output/analog	0-5 V or 0-10 V 1/10/100 mV/°C
Output/alarm	24 V/50 mA (open collector)
Output/digital	uni-/bidirectional, 9,6 kBaud, 0/3V digital level, USB optional
Input (0-10 V)	Programmable functional input for external emissivity setting/ambient temperature adjustment, triggered signal output or peak-hold function
LED-functions	alarm indication, automatic aiming support, self diagnostic, temperature indication (via. temp.code)
Cable length	head - electronics: 0.5 m (standard), 3 m, 6 m after electronics: 0.5 m (standard), 3 m
Power supply	5-30 V DC
Current draw	9 mA

Measurement Specifications

Temperature range (scalable via software)	-40°C - 1030°C
Spectral range	8 - 14 μm
Optical resolution (90 % energy)	15:1 (precision glass optics) 2:1 (with flat front window)
CF-lens (optional)	0.8 mm @ 10 mm (15:1) 2.5 mm @ 23 mm (2:1)
System accuracy	± 1.0% or ± 1.0°C ^{1), 2)}
Repeatability	± 0.5% or ± 0.5°C ^{1), 2)}
Temperature coefficient	± 0.05 K/K oder ± 0.05 %/K ³⁾
Temperature resolution	0.15 K
Response time (90%)	30 ms - 999 s (adjustable)
Emissivity/Gain (adjustable via 0-5 V DC input or software)	0.100 - 1.100
Transmissivity (adjustable via software)	0.100 - 1.100
Signal processing (parameter adjustable via software)	peak hold, valley hold, average; extended hold function with threshold and hysteresis
Dimensions of electronics	length: 35 mm diameter: 12 mm
Software	optris Compact Connect

¹⁾ object temperature > 23°C; whichever is greater

²⁾ at ambient temperature 23 ± 5°C

³⁾ for ambient temperatures <18°C and >28°C; whichever is greater

Optical Specifications

Optics, D:S = 15:1

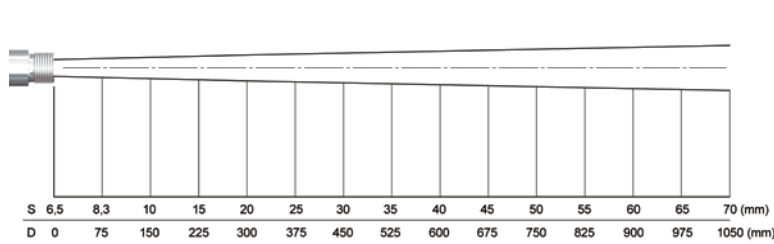

Optics with CF-lens, D:S = 15:1

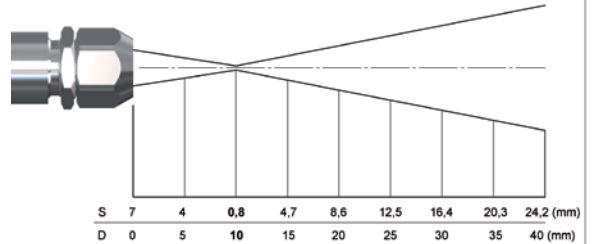

Optics, D:S = 2:1

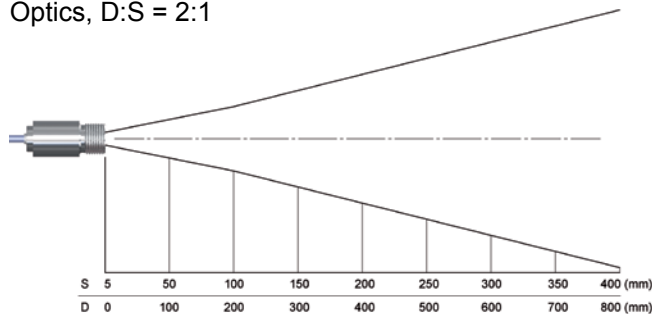

Optics with CF-lens, D:S = 2:1

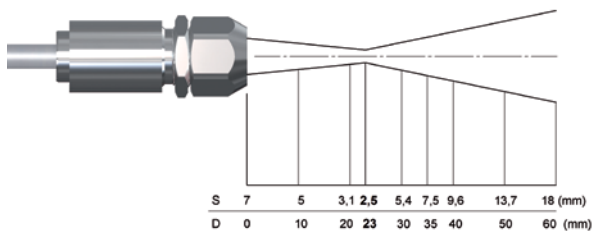

Interfaces/Dimensions

Connection analog with open collector alarm output

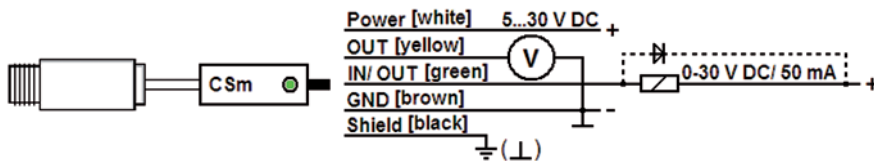

Dimensions optris CSmicro LT

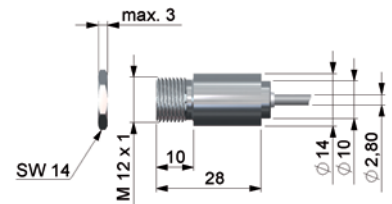

Connection digital with USB adapter cable

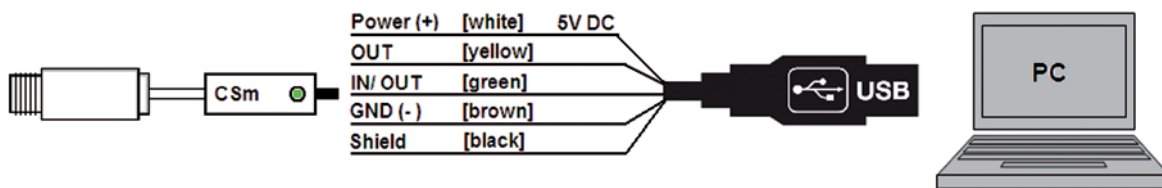

Accessories (examples)

CF-lens (ACCTCF)

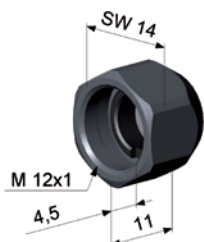

Air purge collar with integrated CF-lens (ACCTAPLCF)

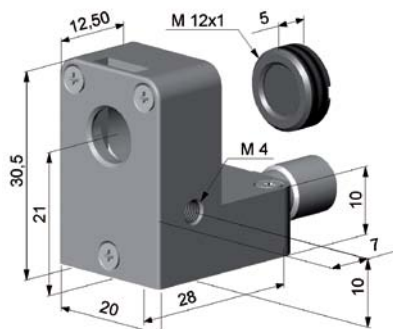

Mounting bracket, fixed (ACCTFB)

