

# **RIGOL**

## **User's Guide**

# **MSO5000 Series Digital Oscilloscope**

**Oct. 2018**  
**RIGOL (SUZHOU) TECHNOLOGIES INC.**



---

# Guaranty and Declaration

## Copyright

© 2018 **RIGOL** (SUZHOU) TECHNOLOGIES INC. All Rights Reserved.

## Trademark Information

**RIGOL** is a registered trademark of **RIGOL** (SUZHOU) TECHNOLOGIES INC.

## Publication Number

UGA25100-1110

## Software Version

00.00.00.SP1

Software upgrade might change or add product features. Please acquire the latest version of the manual from **RIGOL** website or contact **RIGOL** to upgrade the software.

## Notices

- **RIGOL** products are covered by P.R.C. and foreign patents, issued and pending.
- **RIGOL** reserves the right to modify or change parts of or all the specifications and pricing policies at the company's sole decision.
- Information in this publication replaces all previously released materials.
- Information in this publication is subject to change without notice.
- **RIGOL** shall not be liable for either incidental or consequential losses in connection with the furnishing, use, or performance of this manual, as well as any information contained.
- Any part of this document is forbidden to be copied, photocopied, or rearranged without prior written approval of **RIGOL**.

## Product Certification

**RIGOL** guarantees that this product conforms to the national and industrial standards in China as well as the ISO9001:2015 standard and the ISO14001:2015 standard. Other international standard conformance certifications are in progress.

## Contact Us

If you have any problem or requirement when using our products or this manual, please contact **RIGOL**.

E-mail: [service@rigol.com](mailto:service@rigol.com)

Website: [www.rigol.com](http://www.rigol.com)

# Safety Requirement

## General Safety Summary

Please review the following safety precautions carefully before putting the instrument into operation so as to avoid any personal injury or damage to the instrument and any product connected to it. To prevent potential hazards, please follow the instructions specified in this manual to use the instrument properly.

### **Use Proper Power Cord.**

Only the exclusive power cord designed for the instrument and authorized for use within the local country could be used.

### **Ground the Instrument.**

The instrument is grounded through the Protective Earth lead of the power cord. To avoid electric shock, connect the earth terminal of the power cord to the Protective Earth terminal before connecting any input or output terminals.

### **Connect the Probe Correctly.**

If a probe is used, the probe ground lead must be connected to earth ground. Do not connect the ground lead to high voltage. Improper way of connection could result in dangerous voltages being present on the connectors, controls or other surfaces of the oscilloscope and probes, which will cause potential hazards for operators.

### **Observe All Terminal Ratings.**

To avoid fire or shock hazard, observe all ratings and markers on the instrument and check your manual for more information about ratings before connecting the instrument.

### **Use Proper Overvoltage Protection.**

Ensure that no overvoltage (such as that caused by a bolt of lightning) can reach the product. Otherwise, the operator might be exposed to the danger of an electric shock.

### **Do Not Operate Without Covers.**

Do not operate the instrument with covers or panels removed.

### **Do Not Insert Objects Into the Air Outlet.**

Do not insert anything into the holes of the fan to avoid damaging the instrument.

### **Use Proper Fuse.**

Please use the specified fuses.

**Avoid Circuit or Wire Exposure.**

Do not touch exposed junctions and components when the unit is powered on.

**Do Not Operate With Suspected Failures.**

If you suspect that any damage may occur to the instrument, have it inspected by **RIGOL** authorized personnel before further operations. Any maintenance, adjustment or replacement especially to circuits or accessories must be performed by **RIGOL** authorized personnel.

**Provide Adequate Ventilation.**

Inadequate ventilation may cause an increase of temperature in the instrument, which would cause damage to the instrument. So please keep the instrument well ventilated and inspect the air outlet and the fan regularly.

**Do Not Operate in Wet Conditions.**

To avoid short circuit inside the instrument or electric shock, never operate the instrument in a humid environment.

**Do Not Operate in an Explosive Atmosphere.**

To avoid personal injuries or damage to the instrument, never operate the instrument in an explosive atmosphere.

**Keep Product Surfaces Clean and Dry.**

To avoid dust or moisture from affecting the performance of the instrument, keep the surfaces of the instrument clean and dry.

**Prevent Electrostatic Impact.**

Operate the instrument in an electrostatic discharge protective environment to avoid damage induced by static discharges. Always ground both the internal and external conductors of cables to release static before making connections.

**Use the Battery Properly.**

Do not expose the battery (if available) to high temperature or fire. Keep it out of the reach of children. Improper change of a battery (lithium battery) may cause an explosion. Use the **RIGOL** specified battery only.

**Handle with Caution.**

Please handle with care during transportation to avoid damage to keys, knobs, interfaces, and other parts on the panels.

## Safety Notices and Symbols

### Safety Notices in this Manual:

**WARNING**

Indicates a potentially hazardous situation or practice which, if not avoided, will result in serious injury or death.

**CAUTION**

Indicates a potentially hazardous situation or practice which, if not avoided, could result in damage to the product or loss of important data.

### Safety Terms on the Product:

**DANGER** It calls attention to an operation, if not correctly performed, could result in injury or hazard immediately.

**WARNING** It calls attention to an operation, if not correctly performed, could result in potential injury or hazard.

**CAUTION** It calls attention to an operation, if not correctly performed, could result in damage to the product or other devices connected to the product.

### Safety Symbols on the Product:



Hazardous  
Voltage



Safety Warning



Protective Earth  
Terminal



Chassis Ground



Test Ground

## Measurement Category

### Measurement Category

MSO5000 series digital oscilloscopes can make measurements in Measurement Category I.



---

**WARNING**

This oscilloscope can only be used for measurements within its specified measurement categories.

---

### Measurement Category Definitions

Measurement category I is for measurements performed on circuits not directly connected to MAINS. Examples are measurements on circuits not derived from MAINS, and specially protected (internal) MAINS derived circuits. In the latter case, transient stresses are variable. Thus, you must know the transient withstand capability of the equipment.

Measurement category II is for measurements performed on circuits directly connected to low voltage installation. Examples are measurements on household appliances, portable tools and similar equipment.

Measurement category III is for measurements performed in the building installation. Examples are measurements on distribution boards, circuit-breakers, wiring (including cables, bus-bars, junction boxes, switches and socket-outlets) in the fixed installation, and equipment for industrial use and some other equipment. For example, stationary motors with permanent connection to a fixed installation.

Measurement category IV is for measurements performed at the source of a low-voltage installation. Examples are electricity meters and measurements on primary overcurrent protection devices and ripple control units.

## Ventilation Requirement

This oscilloscope uses a fan to force cooling. Please make sure that the air intake and exhaust areas are free from obstructions and have free air. When using the oscilloscope in a bench-top or rack setting, provide at least 10 cm clearance beside, above and behind the instrument for adequate ventilation.



---

**WARNING**

Inadequate ventilation may cause an increase of temperature in the instrument, which would cause damage to the instrument. So please keep the instrument well ventilated and inspect the air outlet and the fan regularly.

---

## Working Environment

### Temperature

Operating: 0°C to +50°C

Non-operating: -30°C to +70°C

### Humidity

Operating:

Below +30°C: ≤95%RH (without condensation)

+30°C to +40°C: ≤75%RH (without condensation)

+40°C to +50°C: ≤45%RH (without condensation)

Non-operating:

Below 65°C: ≤95% RH (without condensation)



### **WARNING**

To avoid short circuit inside the instrument or electric shock, never operate the instrument in a humid environment.

---

### Altitude

Operating: below 3 km

Non-operating: below 15 km

### Installation (Overvoltage) Category

This product is powered by mains conforming to installation (overvoltage) category II.



### **WARNING**

Ensure that no overvoltage (such as that caused by a bolt of lightning) can reach the product. Otherwise, the operator might be exposed to the danger of an electric shock.

---

### Installation (Overvoltage) Category Definitions

Installation (overvoltage) category I refers to signal level which is applicable to equipment measurement terminals connected to the source circuit. Among these terminals, precautions are done to limit the transient voltage to a low level.

Installation (overvoltage) category II refers to the local power distribution level which is applicable to equipment connected to the AC line (AC power).

### Pollution Degree

Pollution Degree 2

### Pollution Degree Definition

Pollution Degree 1: No pollution or only dry, nonconductive pollution occurs. The



pollution has no effect. For example, a clean room or air-conditioned office environment.

Pollution Degree 2: Normally only nonconductive pollution occurs. Temporary conductivity caused by condensation is to be expected. For example, indoor environment.

Pollution Degree 3: Conductive pollution or dry nonconductive pollution that becomes conductive due to condensation occurs. To be found in industrial environment or construction sites (harsh environments). For example, sheltered outdoor environment.

Pollution Degree 4: The pollution generates persistent conductivity caused by conductive dust, rain, or snow.

For example, outdoor areas.

### **Safety Class**

Class 1 – Grounded Product

## **Care and Cleaning**

### **Care**

Do not store or leave the instrument where it may be exposed to direct sunlight for long periods of time.

### **Cleaning**

Clean the instrument regularly according to its operating conditions.

1. Disconnect the instrument from all power sources.
2. Clean the external surfaces of the instrument with a soft cloth dampened with mild detergent or water. When cleaning the LCD, take care to avoid scarifying it.



---

#### **CAUTION**

To avoid damage to the instrument, do not expose it to caustic liquids.

---



---

#### **WARNING**

To avoid short-circuit resulting from moisture or personal injuries, ensure that the instrument is completely dry before connecting it to the power supply.

---

## **Environmental Considerations**

The following symbol indicates that this product complies with the WEEE Directive 2002/96/EC.



### **Product End-of-Life Handling**

The equipment may contain substances that could be harmful to the environment or human health. To avoid the release of such substances into the environment and avoid harm to human health, we recommend you to recycle this product appropriately to ensure that most materials are reused or recycled properly. Please contact your local authorities for disposal or recycling information.

## MSO5000 Series Overview

MSO5000 series digital oscilloscope is a high-performance oscilloscope model designed based on **RIGOL** UltraVision II technology. With a 9-inch capacitive multi-touch screen, the MSO5000 series integrates 7 independent instruments into one, delivering super sample bandwidth ratio, extremely high memory depth, and other excellent specifications. It is compact and portable in design, and all of the MSO series products support multiple channels, bandwidths, and the upgrade of the analysis software. As it integrates many functions of multiple instruments, different user groups can have more choices in selecting their desired product based on their needs, helping them save their budget to a large extent while enjoying the superior test support and user experience.

### Main Features:

- Analog bandwidth: 350 MHz, 200 MHz, 100 MHz, and 70 MHz; bandwidth upgrade option supported
- 2 or 4 analog channels (upgradable), standard configuration of 16 digital channels (probe option is required to be ordered)
- Up to 8 GSa/s real-time sample rate
- Up to 200 Mpts memory depth (option)
- High waveform capture rate (over 500,000 wfm/s)
- Auto measurement of 41 waveform parameters; full-memory hardware measurement function
- A variety of serial protocol triggers and decodes
- Up to 450,000 frames of hardware real-time and ceaseless waveforms recording and playing functions
- Independent search, navigation keys, and event table
- Built-in advanced power analysis software (option)
- Integrates 7 independent instruments into 1, including a digital oscilloscope, a logic analyzer, a spectrum analyzer, an Arbitrary Waveform Generator, a digital voltmeter, a frequency counter and totalizer, and a protocol analyzer
- 9-inch capacitive multi-touch screen, 256-level intensity grading display, with color persistence
- Multiple interfaces available: USB HOST & DEVICE, LAN(LXI), HDMI, TRIG OUT, and USB-GPIB
- Web Control remote command
- Unique online version upgrade
- Novel and delicate industrial design, easy to operate

# Document Overview

## Main Topics of this Manual:

### **Chapter 1 Quick Start**

Introduces the preparations before using the oscilloscope and provides a basic introduction of the instrument.

### **Chapter 2 To Set the Vertical System**

Introduces the vertical system functions of the oscilloscope.

### **Chapter 3 To Set the Horizontal System**

Introduces the horizontal system functions of the oscilloscope.

### **Chapter 4 To Set the Sample System**

Introduces the sample system functions of the oscilloscope.

### **Chapter 5 To Trigger the Oscilloscope**

Introduces the trigger mode, trigger coupling, trigger holdoff, external trigger, and various trigger types of the oscilloscope.

### **Chapter 6 Operations and Measurements**

Introduces how to make math operation, auto measurement, and cursor measurement.

### **Chapter 7 Digital Voltmeter (DVM) and Frequency Counter**

Introduces how to use the digital voltmeter and the frequency counter.

### **Chapter 8 Power Analysis (Option)**

Introduces the power quality and output ripple noise of the input power.

### **Chapter 9 Histogram Analysis**

Introduces the histogram analysis function.

### **Chapter 10 Digital Channel**

Introduces how to use the digital channels of the mixed signal digital oscilloscope.

### **Chapter 11 Protocol Decoding**

Introduces how to decode the input signal by using those common protocols.

### **Chapter 12 Reference Waveform**

Introduces how to compare the input waveform with the reference waveform.

### **Chapter 13 Pass/Fail Test**

Introduces how to monitor the input signal by using the Pass/Fail test.

**Chapter 14 Waveform Recording & Playing**

Introduces the waveform recording & playing function.

**Chapter 15 Search and Navigation Function**

Introduces the navigation function and how to quickly search the relevant events.

**Chapter 16 Display Control**

Introduces how to control the display of the oscilloscope.

**Chapter 17 Function/Arbitrary Waveform Generator (Option)**

Introduces how to use the built-in Function/Arbitrary Waveform Generator option.

**Chapter 18 Store and Load**

Introduces how to store and load the measurement results and the setting of the oscilloscope.

**Chapter 19 System Utility Function Setting**

Introduces how to set the remote interfaces and system-related functions.

**Chapter 20 Remote Control**

Introduces how to control the oscilloscope remotely.

**Chapter 21 Troubleshooting**

Introduces how to deal with the common failures of the oscilloscope.

**Chapter 22 Appendix**

Provides the basic information for the options and accessories.

## Format Conventions in this Manual:

### 1. Key

The key on the front panel is denoted by the format of "Key Name (Bold) + Text Box" in the manual. For example, **Utility** denotes the "Utility" key.

### 2. Menu

The menu items are denoted by the format of "Menu Word (Bold) + Character Shading". For example, **System** denotes the "System" menu item under **Utility**.







### 3. Operation Procedures:

→ denotes the next step of operation. For example, **Utility** → **System** denotes that first press **Utility**, and then press the **System** key.

### 4. Connector:

The connectors on the front or rear panel are usually denoted by the format of "Connector Name (Bold) + Square Brackets (Bold)". For example, **[TRIG OUT]**.

### 5. Knob

Label	Knob	Label	Knob
Horizontal  <b>SCALE</b>	Horizontal Time Base Knob	Vertical  <b>SCALE</b>	Vertical Scale Knob
Horizontal  <b>POSITION</b>	Horizontal Position Knob	Vertical  <b>OFFSET</b>	Vertical Offset Knob
Trigger  <b>LEVEL</b>	Trigger Level Knob		Multifunction Knob

## Content Conventions in this Manual:

MSO5000 series includes the following models. Unless otherwise specified, this manual takes MSO5354 as an example to illustrate the functions and operation methods of MSO5000 series.

Model	Analog Bandwidth	No. of Analog Channels	No. of Function/Arbitrary Waveform Generator Channels	No. of Digital Channels
MSO5072	70 MHz	2	2, Opt.	16
MSO5074	70 MHz	4	2, Opt.	16
MSO5102	100 MHz	2	2, Opt.	16
MSO5104	100 MHz	4	2, Opt.	16
MSO5204	200 MHz	4	2, Opt.	16
MSO5354	350 MHz	4	2, Opt.	16

**Manuals of this Product:**

Quick Guide, User's Guide, Programming Guide, Data sheet, etc. For the latest version of this manual, download it from the official website of **RIGOL** ([www.rigol.com](http://www.rigol.com)).

# Contents

<b>Guaranty and Declaration</b> .....	<b>I</b>
<b>Safety Requirement</b> .....	<b>II</b>
General Safety Summary.....	II
Safety Notices and Symbols .....	IV
Measurement Category.....	V
Ventilation Requirement.....	V
Working Environment .....	VI
Care and Cleaning.....	VII
Environmental Considerations.....	VII
<b>MSO5000 Series Overview</b> .....	<b>IX</b>
<b>Document Overview</b> .....	<b>X</b>
<b>Chapter 1 Quick Start</b> .....	<b>1-1</b>
General Inspection .....	1-2
Appearance and Dimensions .....	1-3
To Prepare for Use .....	1-4
To Adjust the Supporting Legs .....	1-4
To Connect to AC Power .....	1-4
Turn-on Checkout .....	1-5
To Connect the Probe.....	1-5
Function Inspection .....	1-7
Probe Compensation .....	1-8
Front Panel Overview .....	1-9
Rear Panel Overview .....	1-10
Front Panel Function Overview .....	1-12
Vertical.....	1-12
Horizontal.....	1-13
Trigger .....	1-14
Function Menu .....	1-14
Navigation Control Key .....	1-15
Quick Key (Shortcut Key).....	1-15
Function/Arbitrary Waveform Generator Setting .....	1-16
Clear .....	1-16
Auto.....	1-16
RUN/STOP .....	1-16
Single.....	1-16
Touch Lock Key .....	1-17
Default .....	1-17
Multifunction Knob.....	1-17
User Interface.....	1-18
Touch Screen Controls .....	1-22
Tap .....	1-22



Pinch & Stretch.....	1-22
Drag.....	1-23
Rectangle Drawing.....	1-23
Parameter Setting Method.....	1-25
To Use the Kensington Security Lock.....	1-26
To Use the Built-in Help System.....	1-27
To View the Option Information and the Option Installation.....	1-28
<b>Chapter 2 To Set the Vertical System .....</b>	<b>2-1</b>
To Enable or Disable the Analog Channel.....	2-2
To Adjust the Vertical Scale.....	2-3
Vertical Expansion.....	2-4
To Adjust the Vertical Offset.....	2-4
Channel Coupling.....	2-5
Bandwidth Limit.....	2-5
Probe Ratio.....	2-6
Input Impedance.....	2-7
Waveform Invert.....	2-7
Amplitude Unit.....	2-8
Channel Delay.....	2-8
Offset Cal.....	2-9
Channel Label.....	2-10
<b>Chapter 3 To Set the Horizontal System .....</b>	<b>3-1</b>
To Adjust the Horizontal Time Base.....	3-2
To Adjust the Horizontal Position.....	3-3
Delayed Sweep.....	3-4
<b>Chapter 4 To Set the Sample System.....</b>	<b>4-1</b>
Timebase Mode.....	4-2
YT Mode.....	4-2
XY Mode.....	4-2
ROLL Mode.....	4-4
Acquisition Mode.....	4-5
Normal.....	4-5
Average.....	4-5
Peak.....	4-6
Sampling Mode.....	4-7
Sample Rate.....	4-7
LA Sample Rate.....	4-8
Memory Depth.....	4-9
LA Memory Depth.....	4-10
Anti-Aliasing.....	4-10
Horizontal Expansion.....	4-10
<b>Chapter 5 To Trigger the Oscilloscope .....</b>	<b>5-1</b>
Trigger Source.....	5-2
Trigger LEVEL/Threshold Level.....	5-3

Trigger Mode .....	5-4
Trigger Coupling.....	5-5
Trigger Holdoff.....	5-6
Noise Rejection.....	5-7
Trigger Type .....	5-7
Edge Trigger .....	5-8
Pulse Trigger .....	5-9
Slope Trigger.....	5-11
Video Trigger.....	5-14
Pattern Trigger .....	5-16
Duration Trigger .....	5-18
Timeout Trigger.....	5-20
Runt Trigger.....	5-22
Window Trigger .....	5-24
Delay Trigger .....	5-26
Setup/Hold Trigger.....	5-28
Nth Edge Trigger .....	5-30
RS232 Trigger (Option) .....	5-31
I2C Trigger (Option).....	5-34
SPI Trigger (Option).....	5-36
CAN Trigger (Option) .....	5-38
FlexRay Trigger (Option) .....	5-41
LIN Trigger (Option) .....	5-43
I2S Trigger (Option).....	5-45
MIL-STD-1553 Trigger (Option) .....	5-48
Zone Trigger .....	5-50
Trigger Output Connector.....	5-52
<b>Chapter 6 Operations and Measurements .....</b>	<b>6-1</b>
Math Operation.....	6-2
Addition.....	6-2
Subtraction .....	6-3
Multiplication.....	6-4
Division .....	6-5
FFT .....	6-6
"AND" Operation .....	6-10
"OR" Operation .....	6-11
"XOR" Operation.....	6-12
"NOT" Operation.....	6-14
Intg.....	6-15
Diff .....	6-16
Sqrt.....	6-17
Lg (Base 10 Exponential).....	6-18
Ln .....	6-18
Exp .....	6-19
Abs .....	6-20

Low Pass.....	6-21
High Pass.....	6-22
Band Pass.....	6-23
Band Stop.....	6-24
AX+B.....	6-25
Math Operation Label.....	6-26
Auto Measurement.....	6-27
Quick Measurement after AUTO.....	6-27
Measurement Parameter.....	6-29
Measurement Settings.....	6-35
Remove the Measurement Result.....	6-38
Statistical Function.....	6-38
All Measurement.....	6-39
Cursor Measurement.....	6-39
Manual Mode.....	6-41
Track Mode.....	6-45
XY Mode.....	6-47
Measure Mode.....	6-49
<b>Chapter 7 Digital Voltmeter (DVM) and Frequency Counter .....</b>	<b>7-1</b>
Digital Voltmeter (DVM).....	7-2
To Enable or Disable DVM Measurement.....	7-2
To Select the Measurement Source.....	7-2
To Select Measurement Mode.....	7-3
To Set the Limits.....	7-3
Frequency Counter.....	7-4
To Enable or Disable the Frequency Counter.....	7-4
To Select the Measurement Source.....	7-4
To Select the Measurement Item.....	7-4
To Set Resolution.....	7-5
To Clear Count.....	7-5
To Enable or Disable the Statistical Function.....	7-5
<b>Chapter 8 Power Analysis (Option).....</b>	<b>8-1</b>
Power Quality.....	8-2
Ripple.....	8-4
<b>Chapter 9 Histogram Analysis .....</b>	<b>9-1</b>
To Enable or Disable the Histogram Function.....	9-2
To Select the Histogram Type.....	9-2
To Select the Histogram Source.....	9-3
To Set the Histogram Height.....	9-3
To Set the Histogram Range.....	9-3
To Enable or Disable the Statistical Function.....	9-3
To Reset.....	9-4
<b>Chapter 10 Digital Channel.....</b>	<b>10-1</b>
To Select the Digital Channel.....	10-2

To Enable/Disable the Digital Channel .....	10-2
To Set the Threshold and Calibrate Probe .....	10-3
Auto Arrangement Setting .....	10-4
To Set the Waveform Display Size .....	10-4
To Set the Label .....	10-4
Group Setting .....	10-5
Waveform Color of the Digital Channel .....	10-6
<b>Chapter 11 Protocol Decoding .....</b>	<b>11-1</b>
Parallel Decoding .....	11-2
RS232 Decoding (Option) .....	11-7
I2C Decoding (Option) .....	11-14
SPI Decoding (Option) .....	11-18
LIN Decoding (Option) .....	11-23
CAN Decoding (Option) .....	11-28
FlexRay Decoding (Option) .....	11-33
I2S Decoding (Option) .....	11-37
1553B Decoding (Option) .....	11-41
<b>Chapter 12 Reference Waveform .....</b>	<b>12-1</b>
To Enable Ref Function .....	12-2
To Select the Reference Channel .....	12-2
To Select the Ref Source .....	12-2
To Adjust the Ref Waveform Display .....	12-2
To Save to Internal Memory .....	12-3
To Clear the Display of the Reference Waveform .....	12-3
To View Details of the Reference Waveform .....	12-3
To Reset the Reference Waveform .....	12-4
Color Setting .....	12-4
Label Setting .....	12-4
To Export to Internal or External Memory .....	12-5
To Import from Internal or External Memory .....	12-5
<b>Chapter 13 Pass/Fail Test .....</b>	<b>13-1</b>
To Enable or Disable the Pass/Fail Test Function .....	13-2
To Start or Stop the Pass/Fail Test Operation .....	13-2
To Select the Source .....	13-2
To Create a Mask .....	13-3
To Save the Mask .....	13-3
To Load a Mask .....	13-3
To Set the Output Form of the Test Results .....	13-4
To Enable or Disable the Display of the Statistics of the Test Results .....	13-5
Statistics Reset .....	13-5
<b>Chapter 14 Waveform Recording &amp; Playing .....</b>	<b>14-1</b>
Common Settings .....	14-2
Record Options .....	14-3
Play Options .....	14-4

<b>Chapter 15 Search and Navigation Function.....</b>	<b>15-1</b>
Search Function .....	15-2
Navigation Function.....	15-4
<b>Chapter 16 Display Control.....</b>	<b>16-1</b>
To Select the Display Type.....	16-2
To Set the Persistence Time .....	16-2
To Set the Waveform Intensity.....	16-3
To Set the Screen Grid .....	16-3
To Set the Grid Brightness.....	16-4
Scale.....	16-4
Color Grade .....	16-4
Waveform Freeze .....	16-4
Screen Saver.....	16-4
<b>Chapter 17 Function/Arbitrary Waveform Generator (Option).....</b>	<b>17-1</b>
To Output Basic Waveforms.....	17-2
To Output Sine .....	17-2
To Output Square .....	17-3
To Output Ramp .....	17-4
To Output Pulse .....	17-4
To Output DC .....	17-5
To Output Noise.....	17-5
Sinc.....	17-6
Exp.Rise.....	17-6
Exp.Fall.....	17-7
ECG.....	17-7
Gauss .....	17-7
Lorentz .....	17-8
Haversine.....	17-8
To Output the Arbitrary Waveform.....	17-9
To Load the Channel and Waveform.....	17-9
To Create the Waveform .....	17-10
To Edit Waveforms .....	17-12
Modulation .....	17-13
AM .....	17-14
FM .....	17-15
FSK .....	17-15
Sweep.....	17-16
Burst.....	17-18
<b>Chapter 18 Store and Load .....</b>	<b>18-1</b>
Storage System .....	18-2
Storage Type .....	18-2
Load Type.....	18-3
Internal Storage and Load.....	18-4
External Storage and Load .....	18-6

Disk Management .....	18-6
To Select a File Type .....	18-7
To Create a Folder .....	18-7
To Delete a File or Folder.....	18-11
To Copy and Paste a File or Folder.....	18-12
To Rename a File or Folder .....	18-12
To Clear the Internal Memory Safely .....	18-13
Factory Settings .....	18-13
<b>Chapter 19 System Utility Function Setting .....</b>	<b>19-1</b>
Remote Interface Configuration.....	19-2
LAN Configuration .....	19-2
To Set mDNS.....	19-5
To Set HDMI .....	19-5
To Set the GPIB Address .....	19-6
USB Connection.....	19-6
System-related .....	19-7
Beeper .....	19-7
Language .....	19-7
System Information .....	19-7
Power On.....	19-7
Aux Output .....	19-8
Help .....	19-8
Self-calibration .....	19-9
Auto Config.....	19-9
Print Setting.....	19-10
Email.....	19-11
Key Locker.....	19-12
Quick Operation .....	19-13
Self-check.....	19-16
System Time .....	19-17
<b>Chapter 20 Remote Control .....</b>	<b>20-1</b>
Remote Control via USB.....	20-2
Remote Control via LAN.....	20-6
Remote Control via GPIB.....	20-7
<b>Chapter 21 Troubleshooting .....</b>	<b>21-1</b>
<b>Chapter 22 Appendix .....</b>	<b>22-1</b>
Appendix A: Accessories and Options .....	22-1
Appendix B: Warranty.....	22-3
<b>Index .....</b>	<b>1</b>

# Chapter 1 Quick Start

This chapter introduces the precautions when using the oscilloscope for the first time, the front/rear panels of the oscilloscope, the user interface, touch screen controls, and how to use the built-in help system.

Contents in this chapter:

- General Inspection
- Appearance and Dimensions
- To Prepare for Use
- Front Panel Overview
- Rear Panel Overview
- Front Panel Function Overview
- User Interface
- Touch Screen Controls
- Parameter Setting Method
- To Use the Kensington Security Lock
- To Use the Built-in Help System
- To View the Option Information and the Option Installation

## General Inspection

### 1. **Inspect the packaging**

If the packaging has been damaged, do not dispose the damaged packaging or cushioning materials until the shipment has been checked for completeness and has passed both electrical and mechanical tests.

The consigner or carrier shall be liable for the damage to the instrument resulting from shipment. **RIGOL** would not be responsible for free maintenance/rework or replacement of the instrument.

### 2. **Inspect the instrument**

In case of any mechanical damage, missing parts, or failure in passing the electrical and mechanical tests, contact your **RIGOL** sales representative.

### 3. **Check the accessories**

Please check the accessories according to the packing lists. If the accessories are damaged or incomplete, please contact your **RIGOL** sales representative.



# Appearance and Dimensions

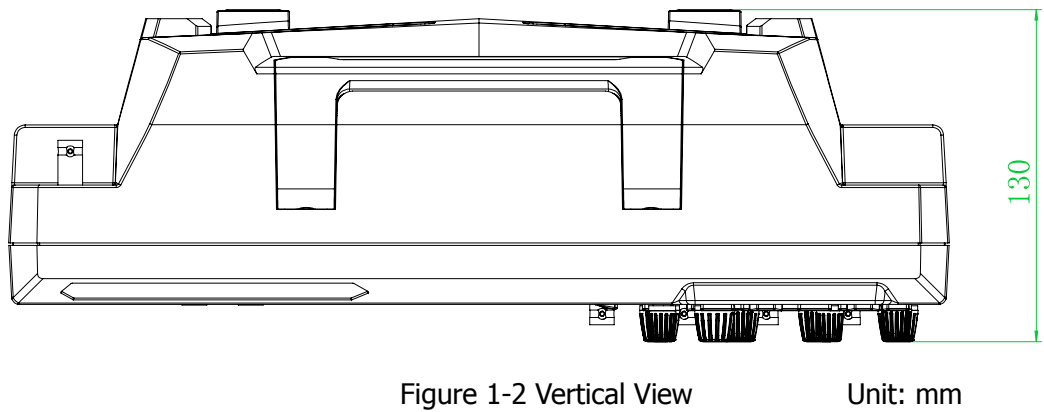
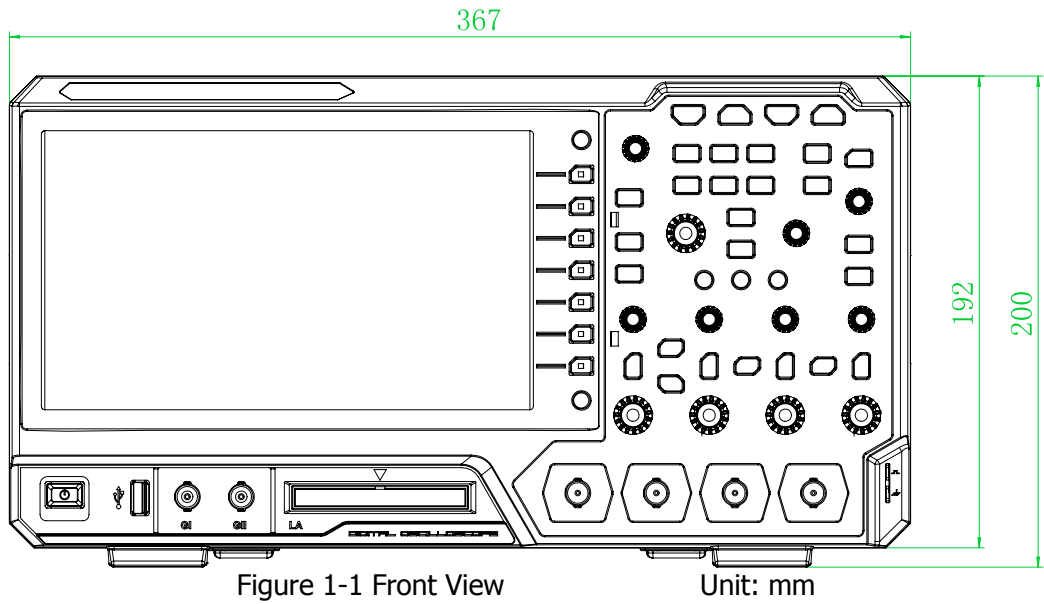

## To Prepare for Use

### To Adjust the Supporting Legs

You can unfold the supporting legs to use them as stands to tilt the instrument upwards for easier operation and observation, as shown in Figure 1-3. You can also fold the supporting legs for easier storage or shipment when the instrument is not in use.

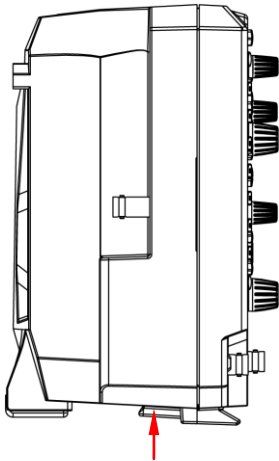

To fold the supporting legs

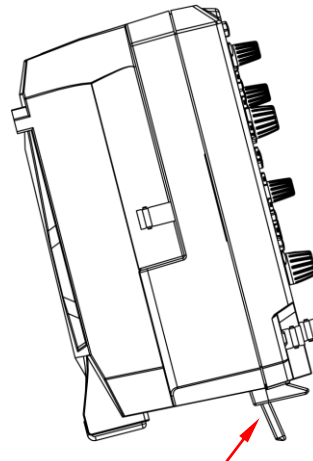

To unfold the supporting legs

Figure 1-3 To Adjust the Supporting Legs

### To Connect to AC Power

The input AC power requirements of the oscilloscope are 100~240 V, 45~440 Hz. Please use the power cord provided in the accessories to connect the oscilloscope to the AC power source via the power cord connector, as shown in Figure 1-4.

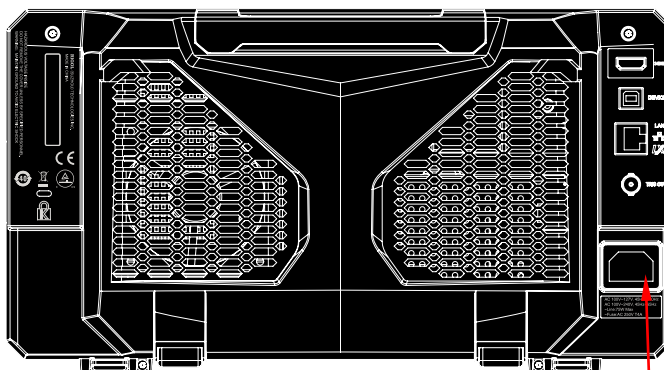

Power Cord Connector

Figure 1-4 To Connect to AC Power

**CAUTION**

To avoid electric shock, ensure that the instrument is correctly grounded.

## Turn-on Checkout

When the oscilloscope is connected to power, press the Power key  at the lower-left corner of the front panel to start the oscilloscope. During the start-up process, the oscilloscope performs a series of self-tests. After the self-test, the welcome screen is displayed.

## To Connect the Probe

**RIGOL** provides the passive probe and the logic probe for MSO5000 series. For specific probe models, please refer to *MSO5000 Series Datasheet*. For detailed technical information of the probes, please refer to the specified Probe User's Guide.

### Connect the passive probe:

1. Connect the BNC terminal of the probe to an analog channel input terminal of the oscilloscope on the front panel, as shown in Figure 1-5.
2. Connect the ground alligator clip or spring of the probe to the circuit ground terminal, and then connect the probe tip to the circuit point to be tested.

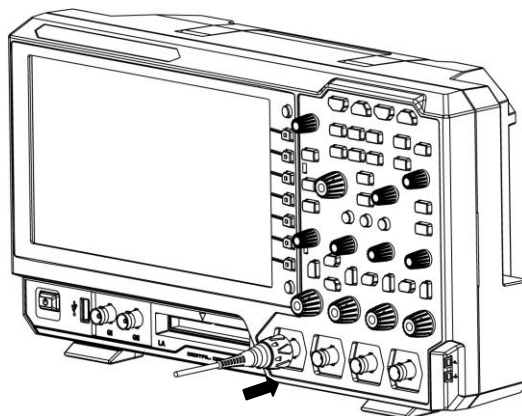

Figure 1-5 To Connect the Passive Probe

After you connect the passive probe, check the probe function and probe compensation adjustment before making measurements. For detailed procedures, refer to "**Function Inspection**" and "**Probe Compensation**".

### Connect the logic probe:

1. Connect the output terminal of the logic probe to the digital channel input terminal on the front panel of the oscilloscope in the correct direction, as shown in Figure 1-6.
2. Connect the other terminal of the logic probe to the signal terminal under test.  
**RIGOL's** MSO5000 series supplies PLA2216 active logic probe option. To apply to different application scenarios, PLA2216 provides two connection methods to connect the signal under test. For details, refer to *PLA2216 Active Logic Probe User's Guide*.

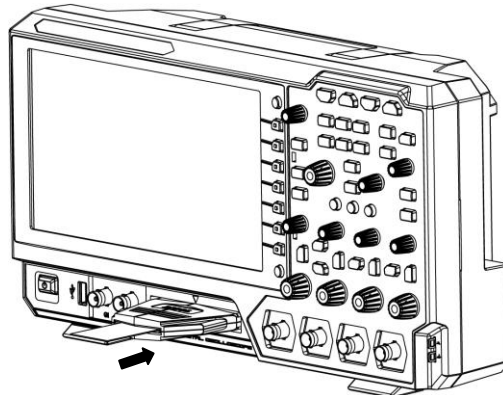

Figure 1-6 To Connect the Logic Probe

**Note:** The digital channel input terminal does not support hot plugging. Please do not insert or pull out the logic probe when the instrument is in power-on state.

## Function Inspection

1. Press **Default** on the front panel, then a prompt message "Restore default?" is displayed. Press **OK** or tap **OK** to restore the instrument to its factory default settings.
2. Connect the ground alligator clip of the probe to the "Ground Terminal" as shown in Figure 1-7 below.
3. Use the probe to connect the input terminal of CH1 of the oscilloscope and the "Compensation Signal Output Terminal" of the probe, as shown in Figure 1-7.

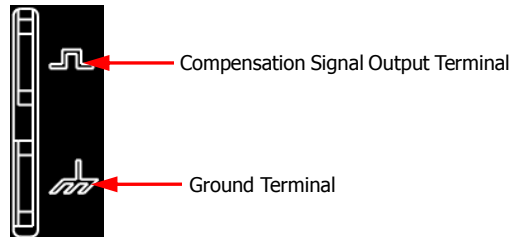

Figure 1-7 To Use the Compensation Signal

4. Set the probe attenuation to 10X, and then press **AUTO**.
5. Observe the waveform on the display. In normal condition, the square waveform as shown in Figure 1-8 should be displayed.



Figure 1-8 Square Waveform Signal

6. Use the same method to test the other channels. If the square waveforms actually shown do not match that in the figure above, please perform **"Probe Compensation"** introduced in the next section.

**WARNING**

To avoid electric shock when using the probe, please make sure that the insulated wire of the probe is in good condition. Do not touch the metallic part of the probe when the probe is connected to high voltage source.

**Tip**

The probe compensation signal can only be used for probe compensation adjustment and cannot be used for calibration.

## Probe Compensation

When the probes are used for the first time, you should compensate the probes to make them match the input channels of the oscilloscope. Non-compensated or poorly compensated probes may cause measurement inaccuracy or errors. The probe compensation procedures are as follows:

1. Perform Step 1, 2, 3 and 4 specified in "**Function Inspection**".
2. Check the displayed waveforms and compare them with Figure 1-9.

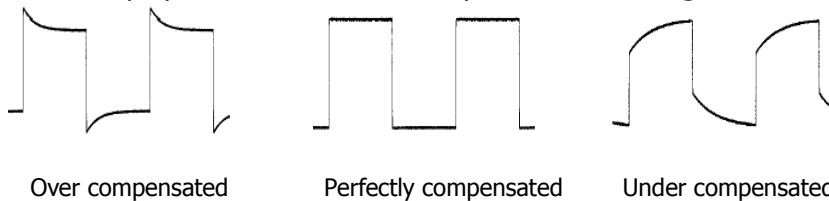

Figure 1-9 Probe Compensation

3. Use a nonmetallic screwdriver to adjust the low-frequency compensation adjustment hole on the probe until the waveform is displayed as "Perfectly compensated" in the figure above.

## Front Panel Overview

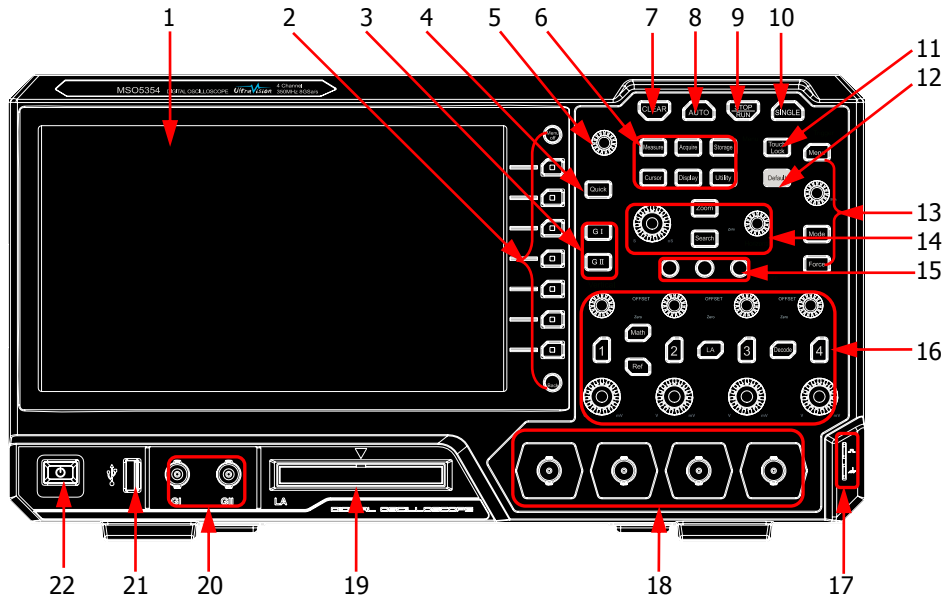

Figure 1-10 Front Panel

Table 1-1 Front Panel Description

No.	Description	No.	Description
1	Capacitive Touch Screen	12	Default Setting Key
2	Function Menu Operation Keys	13	Trigger Control System
3	Dual-channel Function/Arbitrary Waveform Generator Setting Key <sup>[1]</sup>	14	Horizontal Control System
4	Quick Key (Shortcut Key)	15	Navigation Control key
5	Multifunction Knob	16	Vertical Control System
6	Common Operation Keys	17	Probe Compensation Signal Output Terminal/Ground Terminal
7	CLEAR Key	18	Analog Channel Input Terminals
8	Auto Waveform Display Key	19	Digital Channel Input Interface <sup>[2]</sup>
9	RUN/STOP Key	20	Dual-channel Function/Arbitrary Waveform Generator Output Terminals <sup>[1]</sup>
10	Single Trigger Control Key	21	USB HOST Interface
11	Touch Lock Key	22	Power Key

**Note**<sup>[1]</sup>: This function is only available for the model installed with the MSO5000-AWG option.

**Note**<sup>[2]</sup>: PLA2216 active logic probe option is required to be ordered.

## Rear Panel Overview

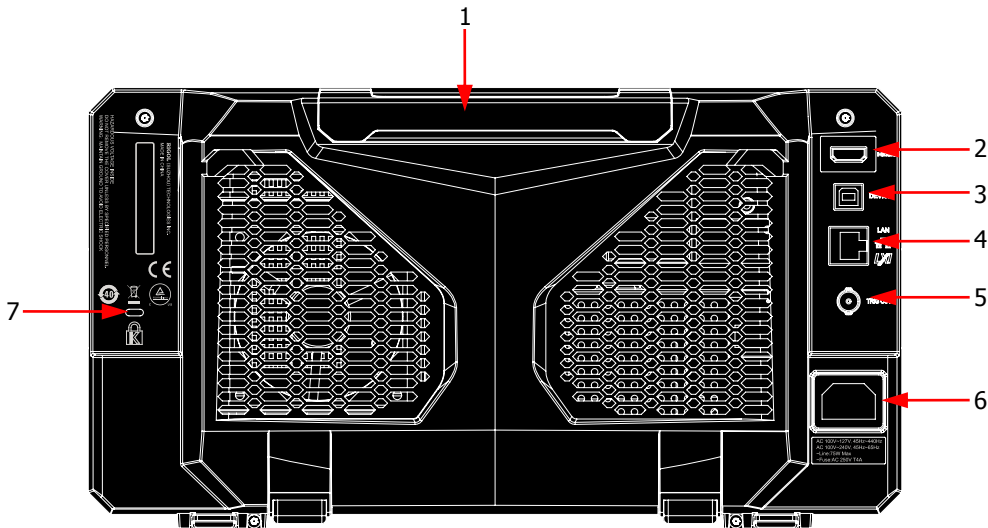

Figure 1-11 Rear Panel

### 1. Handle

Rotate the handle upright to carry the instrument easily. Rotate it downward if you do not need to carry it.

### 2. HDMI

Through this interface, you can connect the instrument to an external display equipped with the HDMI interface (e.g. monitor or projector) to better observe the waveform display clearly. At this time, you can also view the waveforms on the LCD of the instrument.

### 3. USB DEVICE Interface

You can connect the instrument to the PC via this interface. Then you can use the PC software Ultra Scope to send the SCPI commands, the user-defined programming, or Web Control to control the instrument.

### 4. LAN Interface

Connect the instrument to network via this interface. The instrument is in compliance with the standards specified in LXI Device Specification 2011. It can be used to set up a test system.

When you access to the Internet, you can use the Web Control or PC software Ultra Scope to send the SCPI commands or use the user-defined programming to control the instrument. When update is available, you can perform online upgrading for the system software of the instrument via the LAN interface. After it is connected to the network, you can print the waveform displayed on the screen when you use the network printer.



**Tip**

After the oscilloscope is connected to network (if you do not have the access to the Internet, please ask the administrator to open the specified network authority), you can perform online upgrading for the system software:

- 1) Enable the touch screen function. Tap the function navigation icon  at the lower-left corner of the touch screen to enable the function navigation.
- 2) Tap the "Help" icon, and then the "Help" menu is displayed on the screen.
- 3) Press **Online upgrade** or enable the touch screen to tap "Online upgrade", then a "System Update Information" window is displayed, requesting you whether to accept or cancel "RIGOL TERMS OF ONLINE UPGRADE SERVICE". Tap "Accept" to start online upgrade. Tap "Cancel" to cancel the online upgrade.

**5. Trigger Out and Pass/Fail****● TRIG OUT:**

The oscilloscope can output a signal that can reflect the current capture rate of the oscilloscope at each trigger via this interface. Connect the signal to a waveform display device and measure the frequency of the signal. The measurement result is the same as the current capture rate.

**● Pass/Fail**

The instrument can output a pulse from the **[TRIG OUT]** connector when a pass/failed event is detected during the pass/fail test.

**6. AC Power Cord Connector**

Indicates the input terminal where AC power source is connected. The power supply requirements of the instrument are: 100 V~240 V; 45 Hz~440 Hz. Please use the power cord provided in the accessories to connect the oscilloscope to the AC power source.

**7. Kensington Lock Hole**

You can lock the instrument to a fixed location by using the security lock (please purchase it by yourself) via the lock hole.

# Front Panel Function Overview

## Vertical

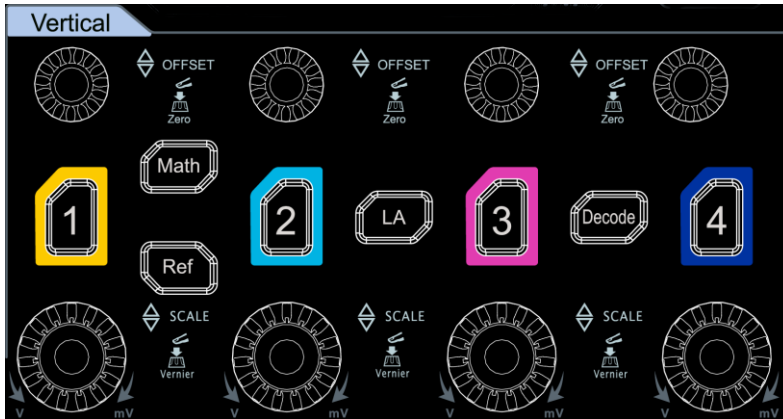



- **1, 2, 3, 4**: indicates the analog channel switch key. The four channels are marked by different colors which are also used to mark both the corresponding waveforms of the specified channel on the screen and the channel input connectors.
- **Math**: indicates the math operation key. Press this key to enable the math operation function. The math operations include  $A+B$ ,  $A-B$ ,  $A \times B$ ,  $A/B$ , and FFT. Besides, you can also set the math operation label.
- **Ref**: indicates the reference waveform key. Press this key to open the reference waveform setting menu. You can compare the actually measured waveform with the reference waveform to locate the circuit failure.
- **LA**: indicates the logic analyzer key. Press this key to open the logic analyzer control menu. You can enable or disable any channel or channel group, modify the waveform sizes of the digital channel, modify the threshold of the digital channel, and group the 16 digital channels. Besides, you can also set a label for each digital channel.
- **Decode**: indicates the decode key. Press this key to open the decode setting menu, and then you can set the decode options. MSO5000 series supports the parallel decoding and many protocol decodings. (For details, refer to the descriptions in "**Protocol Decoding**").
- **Vertical**  **OFFSET**: indicates the channel vertical offset knob. You can rotate the knob to modify the vertical offset of the current channel waveform.

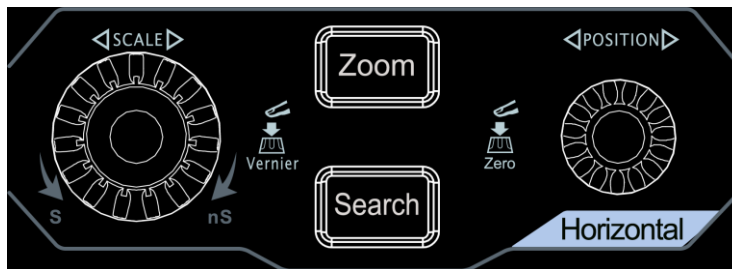

Each analog channel is configured with an independent vertical offset adjustment knob. Turn it clockwise to increase the offset, and turn it counterclockwise to decrease the offset. During the modification, the waveform would move up and down. Meanwhile, the offset information in the corresponding status label would change accordingly. Press down this knob to quickly reset the vertical offset to zero.

- **Vertical  SCALE:** indicates the channel vertical scale knob. Modify the vertical scale of the current channel. Each analog channel is configured with an independent vertical scale adjustment knob. Turn it clockwise to decrease the scale, and turn it counterclockwise to increase the scale. During the modification, the display amplitude of the waveform will enlarge or reduce. The scale information in the corresponding status label will change accordingly. Press down this knob to quickly switch the vertical scale adjustment mode between "Coarse" and "Fine".

## Horizontal

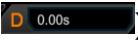

- **Zoom**: indicates the delayed sweep key. Press this key to enable or disable the delayed sweep function.
- **Search**: indicates the Search key. Press this key to enter the search setting menu. The search function allows you to search for relevant events from the collected data based on the search condition that you set.
- **Horizontal  POSITION:** indicates the horizontal position knob. You can rotate the knob to modify the horizontal position (i.g. trigger position). The trigger point would move left or right relative to the center of the screen when you rotate the knob. During the modification, waveforms of all the channels would move left or right, and the horizontal position message (e.g. ) at the upper-right corner of the screen would change accordingly. Press down this knob to quickly reset the horizontal position (or the delayed sweep position).

- **Horizontal  SCALE:** indicates the horizontal time base knob. You can rotate the knob to modify the horizontal time base. Turn it clockwise to decrease the time base, and turn it counterclockwise to increase the time base. During the modification, waveforms of all the channels will be displayed in expanded or compressed form, and the time base message (e.g. ) at the upper section of the screen would change accordingly. Press down this knob to quickly switch the horizontal time base adjustment mode between "Coarse" and "Fine".

## Trigger



- **Menu:** Press this key to open the trigger operation menu. This oscilloscope provides various trigger types.
- **Mode:** Press this key to switch the trigger mode to **Auto Normal**, or **Single**.
- **Force:** Press this key to generate a trigger signal forcibly.
- **Trigger  LEVEL:** modifies the trigger level/threshold level. Turn it clockwise to increase the level, and turn it counterclockwise to decrease the level. During the modification, the trigger level line would move up and down and the trigger level/threshold level value at the upper-right corner of the screen would change accordingly. Press down the knob to quickly set the trigger level to 50% of the waveform peak-peak value.

## Function Menu

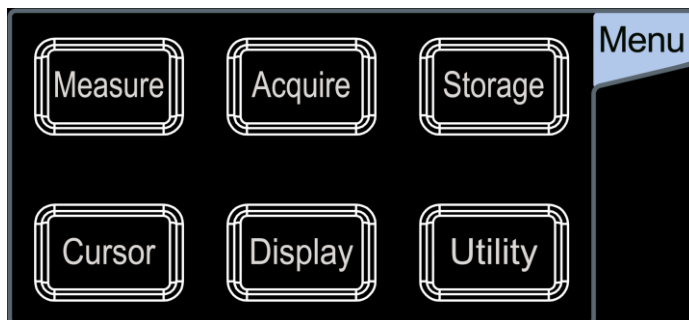

**Measure:** Press this key to enter the measurement setting menu. You can set the measurement source, enable or disable the all measurement function, the statistical

analysis function, and etc. You can make a quick measurement for 41 waveform parameters.

**Acquire**: Press this key to enter the acquisition setting menu. You can set the time base mode, the acquisition mode, memory depth, and etc.

**Storage**: Press this key to enter the file or waveform storage and load interface. The file types for storage include image, waveform, and setups. Besides, waveform load and setup load are supported. The disk management and file auto naming function are also supported in this menu.

**Cursor**: Press this key to enter the cursor measurement menu. The oscilloscope provides four cursor modes: Manual, Track, XY, and Measure. Note that XY cursor mode is only available when the horizontal time base is set to "XY".

**Display**: Press this key to enter the display setting menu. You can set the display type, persistence time, wave intensity, and etc.

**Utility**: Press this key to enter the system function setting menu. You can set system-related functions or parameters, such as I/O, sound, language, and etc. Besides, some advanced functions (such as the pass/fail test, waveform recording, and self-calibration) are also supported.

## Navigation Control Key



With the navigation keys, you can perform recording & playing navigation, time navigation, and event navigation.

## Quick Key (Shortcut Key)



Press this key to perform the quick operation, such as screenshot, waveform saving, setup saving, and etc. Press **Utility** → **More** → **Quick settings** to set the quick shortcut keys.

## Function/Arbitrary Waveform Generator Setting



Press **G I** to enable or disable the output of the **[G I]** connector on the front panel; press **G II** to enable or disable the output of the **[G II]** connector on the front panel; and then enter the corresponding Function/Arbitrary Waveform Generator setting interface. Enable or disable the status display of the current signal.

**Note:** This function is only available for the model installed with the MSO5000-AWG option.

## Clear



Press this key to clear all the waveforms on the screen. If the oscilloscope is in the "RUN" state, new waveforms will continue being displayed.

## Auto



Press this key to enable the waveform auto setting function. The oscilloscope will automatically adjust the vertical scale, horizontal time base, and trigger mode according to the input signal to realize optimal waveform display.

## RUN/STOP



Press this key to set the operating state of the oscilloscope to "RUN" or "STOP". In the "RUN" state, the key is illuminated in yellow. In the "STOP" state, the key is illuminated in red.

## Single



Press this key to set the trigger mode to "Single".

## Touch Lock Key



Press this key to disable the touch screen function.

**Note:** By default, the touch screen function of the oscilloscope is always enabled. If you disable the function, press the key again to enable it.

## Default



Press this key to restore the instrument to its factory default settings.

## Multifunction Knob

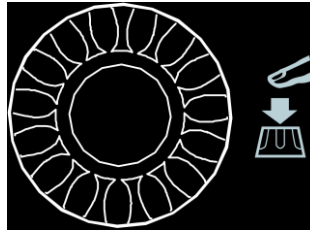

- **Non-menu Operation:**

In non-menu-operation mode, rotate this knob to adjust the brightness of waveform display. The settable screen brightness ranges from 1% to 100%. Turn it clockwise to increase the brightness, and turn it counterclockwise to decrease the brightness. Press **Display** → **Intensity** to adjust the waveform brightness. You can also use the knob to adjust it.

- **Menu Operation:**

In menu-operation mode, for the menu item that has multiple parameters under it, when you press the menu softkey, rotate the knob to select the parameter item, then press down the knob to select it (sometimes, the specified parameter item can be selected by rotating the knob). The knob can also be used to modify parameters, input the filename, etc.

# User Interface

MSO5000 series has a 9-inch WSVGA (1024×600) LCD, with 256 level gray-scale display. The user interface displays the acquired waveforms, the setting information, and the measurement results.

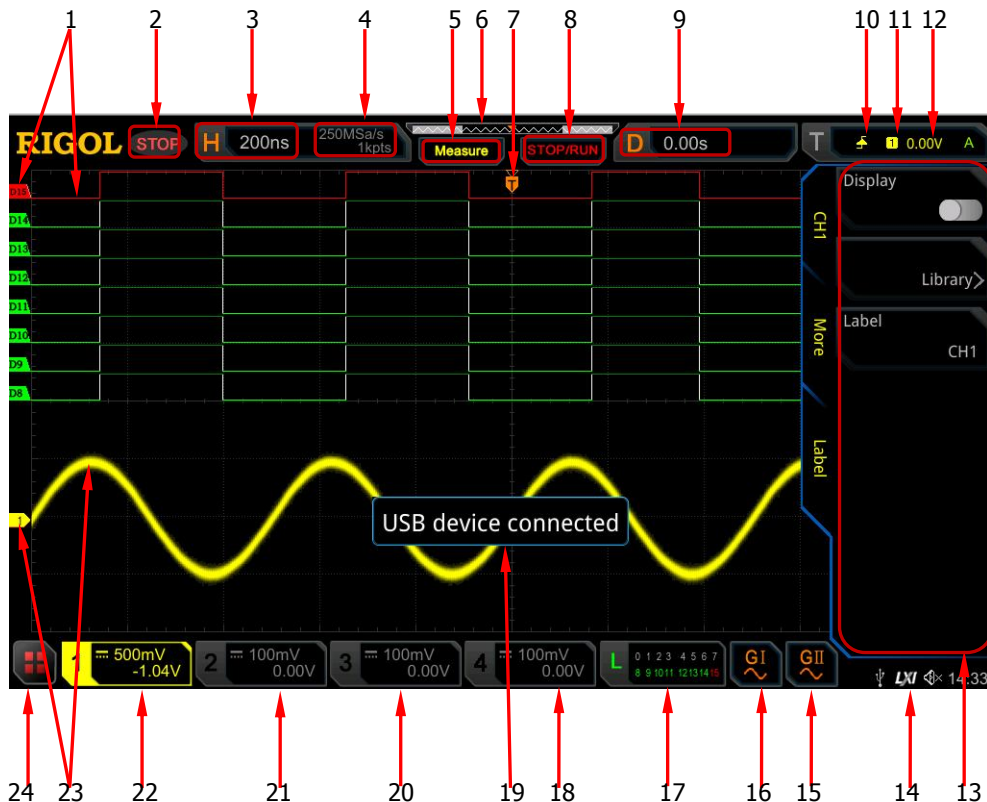

Figure 1-12 User Interface

## 1. Digital Channel Label/Waveform

The logic high and low level of the digital waveform are displayed in green. Its edge is displayed in white. The color of the currently selected waveform of the digital channel is consistent with that of the channel label, being displayed in red. The grouping setting function under the logic analyzer function menu can divide the digital channels into 4 channel groups. The channel label of the same channel group is displayed in the same color; different channel groups are marked with different colors.

## 2. Operating Status

Available states include RUN, STOP, T'D (triggered), WAIT, and AUTO.



### 3. Horizontal Time Base

- Represents the time length per grid in the horizontal axis of the screen.
- Use **Horizontal**  **SCALE** to modify this parameter. The adjustable range of the horizontal time base is different for different models.

### 4. Sample Rate/Memory Depth

Displays the current sample rate and memory depth of the analog channel. The sample rate and the memory depth will change along with the horizontal time base.

### 5. Auto Measurement Label

Enable the touch screen, and then tap the label. Up to 41 waveform parameters are available for auto measurement. It also offers full-memory hardware measurement function.

### 6. Waveform Memory

Provides a diagram of the position of the screen waveform in the memory.

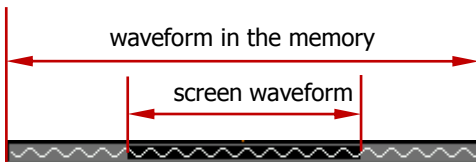

### 7. Trigger Position

Displays the trigger position of the screen waveform and that of the waveform in the memory.

### 8. Run/Stop Label

In the run state, the label is displayed in green; while in the stop state, it is displayed in red. You can enable the touch screen to tap the icon "STOP/RUN" to control its operating status.

### 9. Horizontal Position

Use **Horizontal**  **POSITION** to modify this parameter. Press down this knob to quickly reset the horizontal position.



### 10. Trigger Type



Displays the currently selected trigger type and trigger condition setting. When you select different trigger types, different labels are displayed. For example,  represents triggering on the rising edge in "Edge" trigger.

### 11. Trigger Source

Displays the currently selected trigger source (CH1-CH4, AC Line, or D0-D15). When you select different trigger sources, different labels are displayed. For example,  denotes that CH1 is selected as the trigger source.

## 12. Trigger LEVEL/Threshold Level

- When CH1-CH4 is selected as the trigger source, you need to set a proper trigger level.
- When D0-D15 is selected as the trigger source, you need to set a proper threshold level.
- The trigger level label  is displayed at the left section of the screen, and the trigger level/threshold level value is displayed at the upper-right corner of the screen.
- When you use **Trigger**  **LEVEL** to modify the trigger level/threshold level, the trigger level/threshold level value will change with the up and down of .





**Note:** In Slope Trigger, Runt Trigger, and Window trigger, you need to set the upper and lower limits of the trigger level, and two trigger level labels ( and ) are displayed.

## 13. Operation Menu

Press any softkey on the front panel to activate the corresponding menu.

## 14. Notification Area

Displays the beeper icon, the USB storage device icon, time, and the LAN connection icon.

- Beeper icon: Press **Utility** → **Beeper** to turn on or off the beeper. When the beeper is turned on,  will be displayed; when off,  will be displayed.
- USB storage device icon: When a USB storage device is detected,  will be displayed.
- Time: displays the system time. For the system time setting, refer to descriptions in "**System Time**".
- LAN connection icon: When the LAN interface is successfully connected,  will be displayed.

## 15. AWG 2

- Displays the on/off status of AWG 2.
- Displays the waveform type set for the current AWG2.
- It is only available for the model installed with the MSO5000-AWG option.

## 16. AWG 1



- Displays the on/off status of AWG 1.
- Displays the waveform type set for the current AWG1.
- It is only available for the model installed with the MSO5000-AWG option.

## 17. Digital Channel Status Area

Displays the current status of the 16 digital channels. The digital channels currently turned on are displayed in green, and the currently selected digital

channel is highlighted in red. The digital channels turned off are displayed in gray.



### 18. CH4 Status Label

- Displays the status of CH4.
- Displays the vertical scale of CH4. That is, the voltage value per grid of CH4 in the vertical axis.
- Displays the offset of CH4, i.g. the vertical offset of CH4 waveform.
- Different labels will be displayed according to the current channel setting. For example, if you select "DC" for channel coupling,  is displayed; if you enable the bandwidth limit,  is displayed.



### 19. Message Box

Displays the prompt messages.



### 20. CH3 Status Label

- Displays the status of CH3.
- Displays the vertical scale of CH3. That is, the voltage value per grid of CH3 in the vertical axis.
- Displays the offset of CH3, i.g. the vertical offset of CH3 waveform.
- Different labels will be displayed according to the current channel setting. For example, if you select "DC" for channel coupling,  is displayed; if you enable the bandwidth limit,  is displayed.

### 21. CH2 Status Label

- Displays the status of CH2.
- Displays the vertical scale of CH2. That is, the voltage value per grid of CH2 in the vertical axis.
- Displays the offset of CH2, i.g. the vertical offset of CH2 waveform.
- Different labels will be displayed according to the current channel setting. For example, if you select "DC" for channel coupling,  is displayed; if you enable the bandwidth limit,  is displayed.

### 22. CH1 Status Label

- Displays the status of CH1.
- Displays the vertical scale of CH1. That is, the voltage value per grid of CH1 in the vertical axis.
- Displays the offset of CH1, i.g. the vertical offset of CH1 waveform.
- Different labels will be displayed according to the current channel setting. For example, if you select "DC" for channel coupling,  is displayed; if you enable the bandwidth limit,  is displayed.

### 23. Analog Channel Label/Waveform

Different channels are marked with different colors. The color of the channel label is the same as that of the waveform.

## 24. Function Navigation

Enable the touch screen and then tap this icon to enable the function navigation.

# Touch Screen Controls

MSO5000 series provides a 9-inch super large capacitive touch screen, which supports multi-touch and gesture operation. It has strong waveform display capability and excellent user experience. It features great convenience, high flexibility, and great sensitivity. The actions supported by the touch screen controls include tapping, pinching & stretching, dragging, and rectangle drawing.

### Tip

The touch screen function is available for all the menus displayed on the screen and the buttons enabled. In this manual, key operation descriptions are illustrated in details, and as for the touch screen function about some operations, refer to descriptions in relevant chapters.

## Tap

Use one finger to touch the symbol or characters on the screen slightly, as shown in Figure 1-13. The functions of the tap action include:

- Tap the menu displayed on the screen to operate on the menu.
- Tap the function navigation icon  at the lower-left corner of the touch screen to enable the function navigation.
- Tap the displayed numeric keypad to set the parameters.
- Tap the virtual keypad to set the label name and the filename.
- Tap the close button at the upper-right corner of the message box to close the prompt window.
- Tap other windows on the touch screen and operate on the windows.



Figure 1-13 Tap Gesture

## Pinch & Stretch

Pinch or stretch two points on the screen with two fingers to zoom in or out the waveform. To zoom in the waveform, first pinch the two fingers and then stretch the fingers; to zoom out the waveform, first stretch the two fingers, and then pinch the fingers together, as shown in Figure 1-14. The functions of the pinch & stretch action include:

- Pinching & stretching in the horizontal direction can adjust the horizontal time base of the waveform.
- Pinching & stretching in the vertical direction can adjust the vertical scale of the waveform.



Figure 1-14 Pinch &amp; Stretch Gesture

## Drag

Use one finger to select the object, and then drag the object to a destination place, as shown in Figure 1-15. The functions of the drag action include:

- Drag the waveform to change its position or offset.
- Drag the window controls to change the positions of the window (e.g. numeric keypad).
- Drag the marker to change the position of the marker.

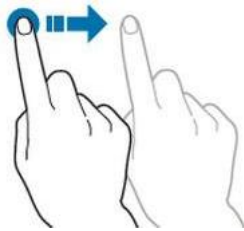

Figure 1-15 Drag Gesture

## Rectangle Drawing

Enable the function navigation, and then tap the "Draw rect" icon to switch to the rectangle drawing mode. Drag to draw a rectangle on the screen, as shown in Figure 1-16. Move your finger away from the screen, and then a menu is displayed on the screen. At this time, you can tap to select "Trigger zone A", "Trigger zone B", "Histogram", "Horizontal zoom", "Vertical zoom", or "Waveform zoom".

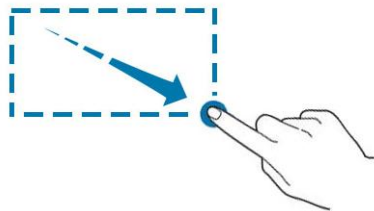



Figure 1-16 Rectangle Drawing Gesture

- Select "Trigger zone A":
  - Draw the region for Trigger zone A;
  - Open Trigger zone A;
  - Open the "Zone Trigger" menu.
- Select "Trigger zone B":
  - Draw the area for Trigger zone B;
  - Open Trigger zone B;
  - Open the "Zone Trigger" menu.
- Select "Histogram":
  - Draw the region for the histogram;
  - Open the "Histogram" menu.
- Select "Horizontal zoom": expands the waveforms in the horizontal direction.
- Select "Vertical zoom": expands the waveforms in the vertical direction.
- Select "Waveform zoom": expands the waveforms both in the horizontal and vertical direction.

**Tip**



Tap the "Draw rect" icon to switch between the rectangle drawing and waveform operation modes.

Tap the "Draw rect" icon, if  is displayed, it indicates that the rectangle drawing mode is enabled. Tap the "Draw rect" icon, if  is displayed, it indicates that the waveform operation mode is enabled. By default, the waveform operation mode is enabled.



## Parameter Setting Method

You can use the knob or enable the touch screen to set the parameters of MSO5000 series. The common parameter setting methods are as follows:



### Method 1:

For the parameters with the sign , rotate the multifunction knob  on the front panel directly to select the parameter item or modify the parameter value.

### Method 2:

For the parameters with the sign , rotate the multifunction knob  on the front panel and press it down to select the parameter item or modify the parameter value.

### Method 3:

For the parameters with  displayed on the menu, rotate the multifunction knob  on the front panel directly to set the parameter, or press down the multifunction knob  or the specified menu softkey, and then the numeric keypad is shown in Figure 1-17 below.

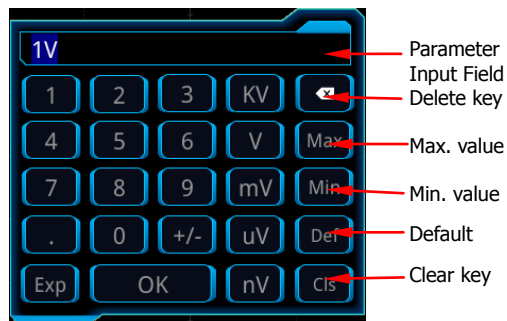

Figure 1-17 Numeric Keypad

In the numeric keypad, rotate the multifunction knob to select the parameter, then press down the knob to select it. Then input the value or the unit. You can also enable the touch screen and tap the value or unit in the numeric keypad to input them. After you input all the values and select the desired units, the numeric keypad is turned off automatically. This indicates that you have completed parameter setting. Besides, after you have input the values, you can also press **OK** directly to close the numeric keypad. At this time, the unit of the parameter is the default unit. In the numeric keypad, you can also perform the following operations:

- Delete the parameter value that has been input.
- Set the parameter to a maximum or minimum value (sometimes, the maximum or minimum value are the specified one for the current state).
- Set the parameter to a default value.
- Clear the parameter input field.

**Method 4:**

For the parameters without the above signs, press the desired menu softkey to switch between the parameter items. This method is applicable to the parameters with only two available options.

**Tip**

The above method is commonly used for the parameter settings of the oscilloscope. For other methods of parameter settings, refer to details in relevant chapters.

## To Use the Kensington Security Lock

If necessary, you can lock the instrument to a fixed location by using the Kensington security lock (please purchase it by yourself), as shown in Figure 1-18. The method is as follows: align the lock with the lock hole and plug it into the lock hole vertically, turn the key clockwise to lock the oscilloscope and then pull the key out.

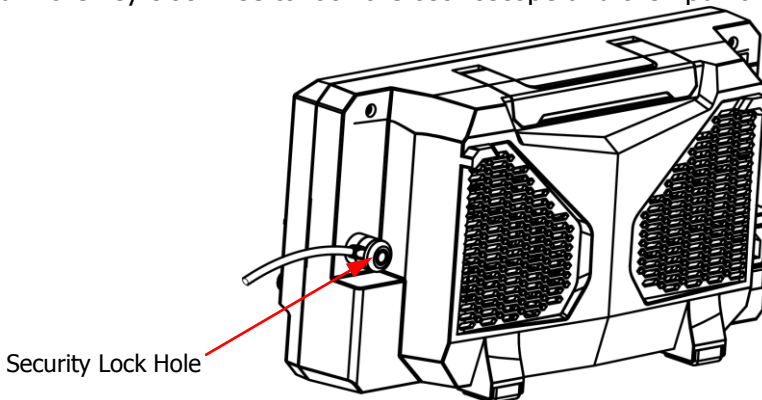



Figure 1-18 To Use the Security Lock

**Note:** Please do not insert other objects into the security lock hole to avoid damaging the instrument.



## To Use the Built-in Help System

The help system of this oscilloscope provides instructions for all the function keys on the front panel and their corresponding menu keys. The steps for opening the built-in help system are as follows:

1. Press **Utility** → **System** → **Help**, and then the "Help" menu is displayed on the screen. You can also use the touch screen function, tap the function navigation icon  at the lower-left corner of the touch screen to enable the function navigation. Tap the "Help" icon, and then the "Help" menu is displayed on the screen.
2. Press **Help** on the front panel or tap the "Help" menu item, and then the help information is displayed on the screen, as shown in Figure 1-19. The help interface mainly consists of two sections. The left section lists "Help Options", and the right section is the "Help Display Area".

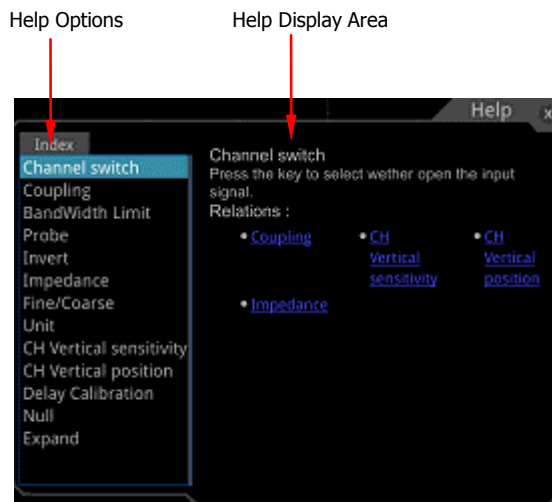



Figure 1-19 Help Information

After opening the help interface, you can get its help information in the "Help Display Area" through the following three methods:

### Method 1:

For the keys, you can directly press the front-panel keys (except the Power key , the **Menu off** key and **Back** key) to obtain the corresponding help information. For the buttons, you can rotate the knob or press down the knob to get the corresponding help information (except the multifunction knob ). As the function of rotating the knob is different from that of pressing down the knob, these two operations will give you different help information.

### Method 2:



In the "Help Options", rotate the multifunction knob  to switch among the help

options to get the corresponding help information.

### Method 3:

Enable the touch screen and tap the desired help option to get the corresponding help information.

#### Tip

- Help information for other keys and buttons:
  - Power key : powers on/off the instrument.
  - **Menu off** key: displays or hides menus. By default, menus are displayed. If menus are hidden, pressing this key can display the menus again.
  - **Back** key: returns to the previous menu or the last set function menu.
  - Multifunction knob : In non-menu-operation mode, rotate this knob to adjust the brightness of waveform display. In menu-operation mode, for the menu item that has multiple parameters under it, when you press the menu softkey, rotate the knob to select the parameter item, then press down the knob to select it (sometimes, the specified parameter item can be selected by rotating the knob). It can also be used to modify parameters, input a filename, etc.
- If the menu item is grayed out, you cannot press the corresponding front-panel menu key to obtain the help information. What you can do is only to follow the above Method 2 or 3 to get the help information.

## To View the Option Information and the Option Installation

MSO5000 series oscilloscope provides multiple options to fulfill your measurement requirements. If you need any of these options, order them according to the Order No. available in "**Appendix A: Accessories and Options**", and then install the options according to this section. Besides, you can also view the options currently installed on the oscilloscope or activate the newly purchased option.

### 1. View the installed option

The instrument is installed with the trial versions of the options before leaving factory. When you power on the instrument for the first time, the trial time is about 2,160 minutes. If your instrument has currently installed the option, perform the following operations to view the name of the installed option and other detailed information about the option from the option list.

- (1) Press **Utility** → **System** → **Help**, and then the "Help" menu is displayed on the screen. You can also use the touch screen function, tap the function navigation icon  at the lower-left corner of the touch screen to enable

the function navigation. Tap the "Help" icon, and then the "Help" menu is displayed on the screen.

- (2) Press the **Option list** key or tap the **Option list** menu item, and then a list of the options installed is displayed on the screen for users to view.

## 2. Install the option

The option license is a string of fixed characters. Each instrument has one unique license. The license file should be in specific format, with the filename extension ".lic". After you purchase an option, you will obtain a key (used for obtaining the license). Then, you can install the option according to the following steps.

### 1) Obtain an option license

- (1) Log in to the **RIGOL** official website (www.rigol.com), click **License Activation** to enter the "Registered product license code" interface.
- (2) In the software license registration interface, input the correct key, serial number (press **Utility** → **System** → **About** to obtain the serial number of the instrument. You can also open the "Help" function menu, and then press **About** to obtain the serial number), and the verification code. Click **Generate** to obtain the download link of the option license file. If you need to use the option license file, please click the link to download the file to the root directory of the USB storage device.

### 2) Install the option

- (1) Confirm that the option license file is located in the root directory of the USB storage device, and connect the USB storage device to the oscilloscope properly.
- (2) The **Option install** key is activated, and press this menu key to start installing the option.
- (3) After installation, a prompt message "Option activated successfully" is displayed.

**Note:** After the option has been installed, you are recommended to restart the instrument.

#### Tip

- Only 1 option license file of one instrument is allowed to be stored in the same USB storage device, but the USB storage device can store the option license file of several different instruments. You are not allowed to modify the licensed filename.
- During the installation process, you are not allowed to power off the instrument or pull out the USB storage device.



## Chapter 2 To Set the Vertical System

MSO5000 series provides two (CH1-CH2, available to be upgraded to 4 channels when installed with the MSO5000-4CH option) or four analog input channels (CH1-CH4), and each channel is equipped with an independent vertical control system. The setting methods for the vertical systems of the four channels are the same. This chapter takes CH1 as an example to introduce the setting method for the vertical system. For this oscilloscope, only CH1 is enabled by default.

Contents in this chapter:

- To Enable or Disable the Analog Channel
- To Adjust the Vertical Scale
- Vertical Expansion
- To Adjust the Vertical Offset
- Channel Coupling
- Bandwidth Limit
- Probe Ratio
- Input Impedance
- Waveform Invert
- Amplitude Unit
- Channel Delay
- Offset Cal
- Channel Label

## To Enable or Disable the Analog Channel

### Enable the analog channel:

Connect a signal to the channel connector of CH1, and then press **1** in the vertical control area (Vertical) on the front panel to enable CH1. Then, the backlight of the channel is illuminated. At this point, the channel setting menu is displayed at the right section of the screen and the channel is activated. The channel status label at the bottom of the screen is shown in the figure below. You can also enable the touch screen to tap the channel status label to enable the channel.



The information displayed in the channel status label is related to the current channel setting but irrelevant with the on/off status of the channel. After the channel is turned on, modify the parameters such as the vertical scale, horizontal time base, trigger mode, and trigger level according to the input signal for easy observation and measurement of the waveform.

If CH1 is enabled but not activated, the channel status label is shown in the following figure. To activate the channel, press **1** on the front panel in the vertical control area (Vertical) or enable the touch screen to tap the waveform activation channel displayed on the screen.



### Disable the analog channel:

If the setting menu of the channel that needs to be disabled (the current channel is activated) is displayed at the right section of the screen, press the channel key to disable the channel. If the setting menu of the channel that needs to be disabled is not displayed at the right section of the screen, first open the setting menu of the channel to be disabled (activate the channel), then press the channel key to disable the channel. You can also enable the touch screen to tap the channel status label to disable the channel. For example, if CH1 and CH2 are enabled, and CH2 channel setting menu is displayed on the screen, then if you need to disable CH1, first activate CH1, and then press **1** or enable the touch screen to tap the CH1 channel status label to disable CH1. If CH1 is disabled, the channel status label is shown in the following figure.

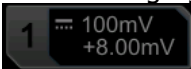



## To Adjust the Vertical Scale

Vertical scale indicates the voltage value per grid in the vertical axis of the screen. It is often expressed in V/div. While you adjust the vertical scale, the display amplitude of the waveform would enlarge or reduce. The scale information of the channel status label (e.g. as shown in the following figure) at the lower section of the screen would change accordingly.





The adjustable range of the vertical scale is related to the currently set probe ratio and input impedance. By default, the probe ratio is 1X and the input impedance is 1 MΩ. In this case, the adjustable range of the vertical scale is from 1 mV/div to 10 V/div.

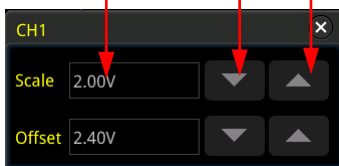

When CH1 is turned on, you can adjust the vertical scale with the following three methods:

- Rotate **Vertical**  **SCALE** that corresponds to CH1 to adjust the vertical scale (clockwise to reduce the scale and counterclockwise to increase).
- Enable the touch screen function and adjust the vertical scale with the pinch & stretch gesture on the touch screen. For details, refer to the "**Pinch & Stretch**" section.
- Enable the touch screen function, and tap the channel status label at the bottom of the screen. The following window is displayed. Tap the   icon at the right side of the **Scale** input field to decrease or increase the scale. You can also tap the **Scale** input field to input a specific value with the displayed numeric keypad.

Value Input Field Decrease Increase



In the vertical control area (Vertical) on the front panel, press **Vertical**  **SCALE** to adjust the vertical scale in "Coarse" (by default) or "Fine" mode. You can also press **1** → **More** → **Fine** to enable or disable fine adjustment.

- Fine adjustment: Rotate **Vertical**  **SCALE** to further adjust the vertical scale within a relatively smaller range to improve vertical resolution. If the amplitude of the input waveform is a little bit greater than the full scale under the current scale and the amplitude would be a little bit lower if the next scale is used, fine adjustment can be used to improve the amplitude of waveform display to view signal details.
- Coarse adjustment (take counterclockwise as an example): Rotate **Vertical** 

**SCALE** to set the vertical scale at 1-2-5 step, i.e. 1 mV/div, 2 mV/div, 5 mV/div, 10 mV/div...10 V/div.

## Vertical Expansion

When changing the vertical scale of the analog channel by rotating the **Vertical SCALE** knob, you can select to expand or compress the waveform around the "Center" or "GND" (Ground). By default, "GND" is selected under Expand.

Press **1** → **More**, then press **Expand** continuously to select "Center" or "GND".

- Center: when the vertical scale is changed, the waveform will be expanded or compressed around the screen center.
- GND: when the vertical scale is changed, the waveform will be expanded or compressed around the signal ground level position.



## To Adjust the Vertical Offset

Vertical offset indicates the offset of the signal ground level position of the waveform from the screen center in the vertical direction. Its unit is consistent with the currently selected amplitude unit (refer to "**Amplitude Unit**"). When adjusting the vertical offset, the waveforms of the corresponding channel moves up and down. The vertical offset information (as shown in the following figure) in the channel status label at the bottom of the screen will change accordingly.



The adjustable range of the vertical offset is related to the current input impedance, probe ratio, and vertical scale.

When CH1 is turned on, you can adjust the vertical offset with the following four methods:

- Rotate **Vertical OFFSET** knob that corresponds to CH1 to adjust the vertical offset within the adjustable range. Rotate this knob clockwise to increase the vertical offset, and rotate it counterclockwise to reduce the vertical offset. Pressing down the knob can quickly reset the vertical offset (set the vertical offset to 0).
- Menu setting: Press **1** → **More** → **Offset**, and then the numeric keypad is displayed. Input the offset value with the numeric keypad.
- Enable the touch screen, and then adjust the vertical offset with the drag gesture. For details, refer to the "**Drag**" section.
- Enable the touch screen function, and tap the channel status label at the bottom of the screen. The following window is displayed. Tap the   icon at the



right side of the **Offset** input field to decrease or increase the offset. You can also tap the **Offset** input field to input a specific value with the displayed numeric keypad.

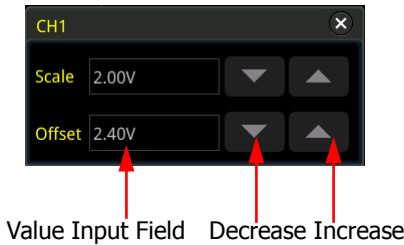

## Channel Coupling

The undesired signals can be filtered out by setting the coupling mode. For example, the signal under test is a square waveform with DC offset.

- When the coupling mode is "DC": the DC and AC components of the signal under test can both pass the channel.
- When the coupling mode is "AC": the DC components of the signal under test are blocked.

Press **1** to open the setting menu of CH1. Then, press **Coupling** continuously or rotate the multifunction knob  to select the desired coupling mode (by default, it is DC). The current coupling mode is displayed in the channel status label at the bottom of the screen, as shown in the figure below. You can also enable the touch screen, and then touch the CH1 setting menu to select the desired coupling mode.



## Bandwidth Limit

MSO5000 series supports the bandwidth limit function. Setting the bandwidth limit can reduce the noises in the displayed waveforms. For example, the signal under test is a pulse with high frequency oscillation.

- When the bandwidth limit is disabled, the high frequency components of the signal under test can pass the channel.
- When you enable the bandwidth limit and limit it to 20 MHz, 100 MHz, or 200 MHz, the high frequency components found in the signal under test that are greater than 20 MHz, 100 MHz, or 200 MHz are attenuated.

Press **1** to open the setting menu of CH1. Then, press **BW Limit** continuously or

rotate the multifunction knob  to select the desired bandwidth limit. Press down the knob to select it. By default, it is OFF. When the bandwidth limit is enabled, the character "B" will be displayed in the channel status label at the bottom of the screen, as shown in the figure below. You can also enable the touch screen, and then tap the CH1 setting menu to select the desired bandwidth limit.



The bandwidth limit that you select is based on the bandwidth of your oscilloscope model, as shown in Table 2-1.

Table 2-1 Bandwidth Limit

Bandwidth of the Oscilloscope Model	Available Bandwidth Limit
70 M and 100 M (MSO5072/MSO5074/MSO5102/MSO5104)	20 M
200 M (MSO5204)	20 M, 100 M
350 M (MSO5354)	20 M, 100 M, 200 M

**Note:** Bandwidth limit can not only reduce the noise, but also can attenuate or eliminate the high frequency components of the signal.

## Probe Ratio

MSO5000 series allows you to set the probe attenuation manually. To obtain the correct measurement results, you must set the probe ratio properly. By default, the probe ratio is 1X.



Press  to open the setting menu of CH1. Then, press **Attenuation** continuously or rotate the multifunction knob  to select the desired probe ratio. You can also enable the touch screen, and then touch the CH1 setting menu to select the desired probe ratio. The probe ratio values available are as shown in Table 2-2.

Table 2-2 Probe Ratio

Menu	Attenuation Ratio (display amplitude of the signal: actual amplitude of the signal)
0.01X	0.01:1
0.02X	0.02:1
0.05X	0.05:1
0.1X	0.1:1
0.2X	0.2:1
0.5X	0.5:1
1X (default)	1:1

2X	2:1
5X	5:1
10X	10:1
20X	20:1
50X	50:1
100X	100:1
200X	200:1
500X	500:1
1000X	1000:1
2000X	2000:1
5000X	5000:1
10000X	10000:1
20000X	20000:1
50000X	50000:1

## Input Impedance

To reduce the circuit load between the oscilloscope and the circuit under test, this oscilloscope provides the default 1 M $\Omega$  input impedance. The **Impedance** menu is grayed out and you are not allowed to set it manually.

## Waveform Invert

Press **1** to open the setting menu of CH1. Then, press **Invert** continuously to enable or disable the waveform invert. When enabled, the channel label is displayed, as shown in the following figure.



When disabled, the waveform is displayed normally; when enabled, the voltage values of the displayed waveform are inverted (as shown in Figure 2-1). Enabling the waveform invert will also change the result of math function and waveform measurement.

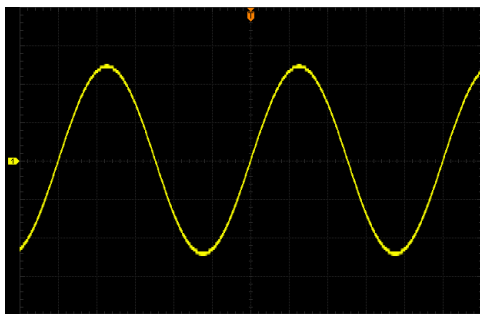

(a) "Invert" Off



(b) "Invert" On

Figure 2-1 Waveform Invert

**Note:** When the waveform invert is enabled, the trigger edge or the trigger polarity will change (e.g. Edge trigger, Pulse trigger, or Slope trigger).

## Amplitude Unit

Select the amplitude display unit for the current channel. The available units are W, A, V, and U. When the unit is changed, the unit related to the relevant functions of the channel will change accordingly.

Press **1** → **More** → **Unit**, press **Unit** continuously or rotate the multifunction knob  to select a unit. You can also enable the touch screen to select the desired unit with touch gestures. The default unit for the value is V.

## Channel Delay

When using an oscilloscope for actual measurement, the transmission delay of the probe cable may bring relatively greater errors (zero offset). MSO5000 allows you to set a delay time for calibrating the zero offset of the corresponding channel. Zero offset is defined as the offset of the crossing point of the waveform and trigger level line relative to the trigger position, as shown in Figure 2-2.

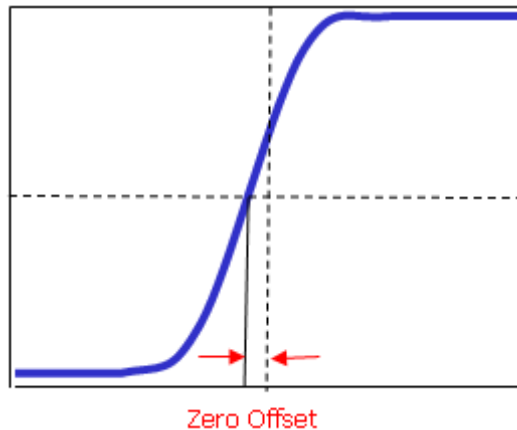



Figure 2-2 Zero Offset

Press **1** → **More** → **Ch-Ch Skew**, rotate the multifunction knob  or use the numeric keypad to set the desired delay calibration time. The available range of the delay calibration time is from -100 ns to 100 ns.

**Note:** This parameter is related to the instrument model and the current horizontal time base setting. The larger the horizontal time base is, the larger the setting step will be.

## Offset Cal

When you use an oscilloscope to make actual measurements, a small offset that arises from the temperature drift of the component or external environment disturbance may occur on the zero-cross voltage of the channel, which will affect the measurement results of the vertical parameters. MSO5000 allows you to set an offset calibration voltage for calibrating the zero point of the corresponding channel, so as to improve the accuracy of the measurement results.

Press **1** → **More** → **Offset Cal**, rotate the multifunction knob  or use the pop-up numeric keypad to set the offset calibration value.

**Note:** If the zero-cross voltage of the channel has a larger amplitude offset that exceeds the adjustable null range, please perform self-calibration for the instrument to ensure the measurement accuracy. For details, refer to descriptions in "**Self-calibration**".

## Channel Label

The instrument uses the channel number to mark the corresponding channel by default. For ease of use, you can also set a label for each channel. For example, "CH1".

Press **1** → **More** → **Label** to enter the label setting menu. You can use the built-in label or manually input a label. Three input methods are available for you to input a label name, including Chinese, English, and Traditional Chinese.

The label setting menu includes the following menu items.

- Press **Display** to turn on or off the display of the channel label. If it is enabled, the label will be displayed at the left side of the waveform. When on, CH1 is, by default, displayed to be the channel label.
- Press **Library** to select the preset labels such as CH1, ACK, ADDR, BIT, CLK, CS, DATA, IN, MISO, MOSI, OUT, RX and TX.
- Press **Label** and the label editing interface is automatically displayed as shown in Figure 2-3. You can input the label manually. For the label input method, refer to "To Create a Folder".

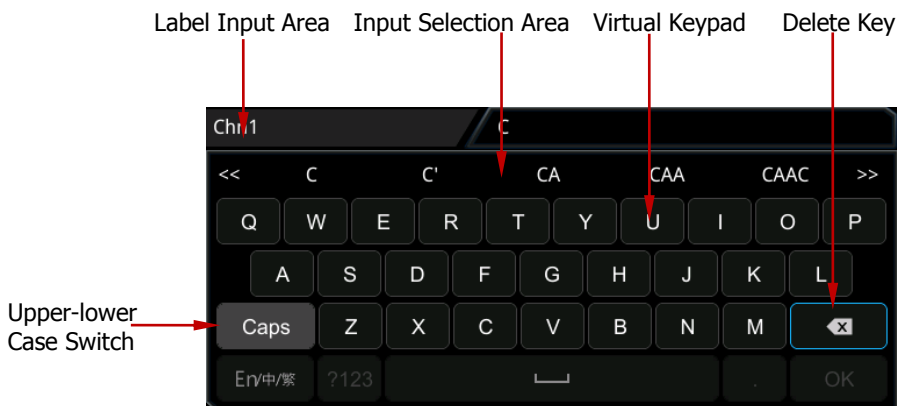





Figure 2-3 Label Editing Interface

For example, set the label to "Chn1". In the virtual keypad, rotate the multifunction knob  to select "Caps" and press down the knob to switch the uppercase or lowercase mode. Rotate the multifunction knob and select "C", press down the knob. Then, in the input selection area, rotate the multifunction knob and select "C". Press down the knob to input "C". Use the same method to input "hn1". After finishing the input, press **OK** to finish the editing. You can also enable the touch screen to operate by touch gestures. If **Display** is enabled, the label **Chn1** will be displayed at the left of CH1 waveform.

To delete or modify the input characters, rotate the multifunction knob  or enable

the touch screen to realize it.

- Rotate the multifunction knob : use the delete key to delete or modify the characters. To modify the characters, input the desired characters again.
- Enable the touch screen: use the touch gestures to directly move the cursor to the right side of the character required to be deleted or modified, and then tap the delete key to delete the character. To modify the characters, input the desired character again or delete the character.





## **Chapter 3 To Set the Horizontal System**

Contents in this chapter:

- To Adjust the Horizontal Time Base
- To Adjust the Horizontal Position
- Delayed Sweep

## To Adjust the Horizontal Time Base

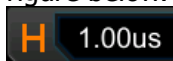

Horizontal time base, also called the horizontal scale, refers to the time of each grid in the horizontal direction of the screen. It is usually expressed in s/div. The adjustable range of the horizontal time base is related to the model type.

While you change the horizontal time base, the displayed waveforms of all channels are expanded or compressed horizontally relative to the current selected horizontal reference baseline (refer to "**Horizontal Expansion**"). The horizontal time base at the upper-left corner of the screen will be changed accordingly, as shown in the figure below.





You can adjust the horizontal time base with the following three methods:

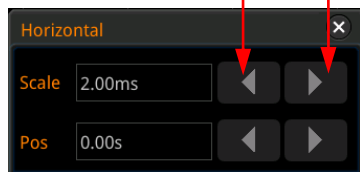

- Rotate **Horizontal**  **SCALE** to adjust the horizontal time base within the available range (clockwise to reduce the horizontal time base and counterclockwise to increase).
- Enable the touch screen function and adjust the horizontal time base with the pinch & stretch gesture on the touch screen. For details, refer to the "**Pinch & Stretch**" section.
- Enable the touch screen function, and tap the horizontal time base label

 at the top of the screen. The following window is displayed. Tap the   icon at the right side of the **Scale** input field to decrease or increase the horizontal scale. You can also tap the **Scale** input field to input a specific value with the displayed numeric keypad.

Decrease    Increase



In the Horizontal control area (Horizontal), rotate the **Horizontal**  **SCALE** knob to switch the adjustment mode between "Coarse" and "Fine" (by default, it is Coarse). You can also press **Acquire** → **Fine** to enable or disable the fine adjustment of the horizontal time base.

- Coarse adjustment: Rotate the **Horizontal**  **SCALE** knob will adjust the horizontal time base of the waveforms of all channels at 1-2-5 step within the adjustable range. Rotate it clockwise to reduce the horizontal time base, and counterclockwise to increase the horizontal time base.
- Fine adjustment: Rotate the **Horizontal**  **SCALE** knob will adjust the horizontal time base of the waveforms of all channels with a minor step value within the adjustable range. Rotate it clockwise to reduce the horizontal time

base, and counterclockwise to increase the horizontal time base.

**Note:** When the delayed sweep is enabled, rotate the **Horizontal**  **SCALE** knob to adjust the time base for the delayed sweep. The delayed sweep time base displayed in the center of the screen will be changed accordingly, as shown in the following figure.

**Zoom:50ns**



## To Adjust the Horizontal Position

Horizontal position, also called trigger position, refers to the trigger point position of the waveforms of all channels in the horizontal direction relative to the screen center. When the waveform trigger point is at the left (right) side of the screen center, the horizontal position is a positive (negative) value.

While you change the horizontal position, the waveform trigger points and the displayed waveforms of all channels are moved left and right. The horizontal position at the right-upper corner of the screen changes accordingly, as shown in the figure below.

**D** 0.00s

You can adjust the horizontal position with the following three methods:

- Rotate **Horizontal**  **POSITION** to adjust the horizontal position of the waveforms of all channels. When you rotate it clockwise, the waveform trigger point moves right on the screen; when you rotate it counterclockwise, the waveform trigger point moves left on the screen. Pressing down the knob can quickly reset the horizontal position (reset to 0).
- Enable the touch screen function and adjust the horizontal position with the drag gesture on the touch screen. For details, refer to the "**Drag**" section.
- Enable the touch screen function, and tap the horizontal position label **D** 0.00s at the top of the screen. The following window is displayed. Tap the   icon at the right side of the **Pos** input field to decrease or increase the horizontal position. You can also tap the **Pos** input field to input a specific value with the displayed numeric keypad.

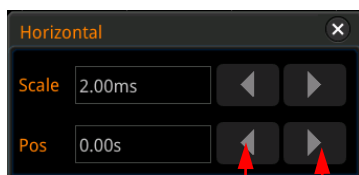

Decrease    Increase

**Note:** When the delayed sweep is enabled, rotate the **Horizontal POSITION** knob to adjust the horizontal position of the delayed sweep (press down the knob to quickly reset it). The horizontal position of the delayed sweep at the upper-right corner of the screen changes accordingly.

## Delayed Sweep

Delayed sweep can be used to enlarge a length of waveform horizontally to view waveform details.

In the horizontal control area on the front panel, press **Zoom** to enable or disable the delayed sweep. By default, it is disabled. You can also press **Acquire** → **More** → **Zoom** to enable or disable the delayed sweep function.

**Note:** To enable the delayed sweep, you must ensure that the current time base mode is "YT".

In delayed sweep mode, the screen is divided into two display areas as shown in Figure 3-1.

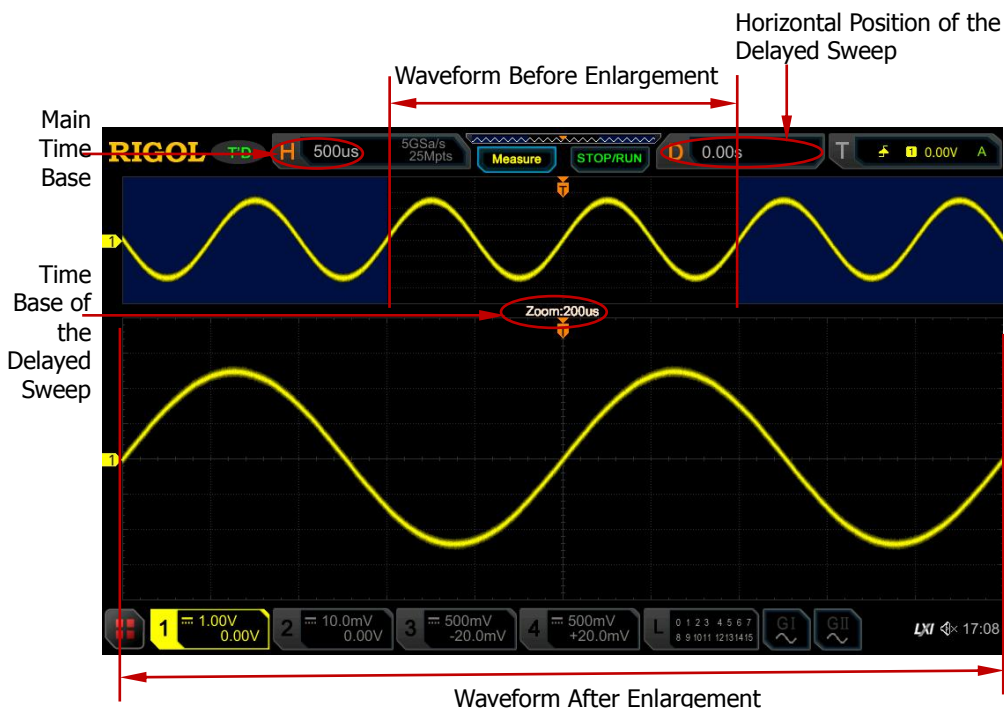







Figure 3-1 Delayed Sweep Mode

**Waveform before enlargement:**

The waveform in the area that is not covered by subtransparent blue in the upper part of the screen is the waveform before enlargement. Its horizontal time base (also called main time base) is displayed at the upper-left corner of the screen. You can rotate the **Horizontal**  **POSITION** knob to move the area left and right or rotate the **Horizontal**  **SCALE** knob to enlarge or reduce this area.

**Note:** If you need to modify the horizontal time base (also called main time base) of the normal sweep, please disable the delayed sweep function first. Rotate the **Horizontal**  **SCALE** knob to set the required main time base, and then enable the delayed sweep function.

**Waveform after enlargement:**

The waveform in the lower part of the screen is the horizontally expanded delayed sweep waveform. Its horizontal time base (also called the time base of the delayed sweep) is displayed on the screen. Compared with the main time base, the time base of the delayed sweep has increased the waveform resolution, as shown in Figure 3-1. At this time, you can rotate the **Horizontal**  **SCALE** knob to adjust the time base of the delayed sweep, and rotate the **Horizontal**  **POSITION** knob to adjust the horizontal position of the delayed sweep.

**Note:** The time base of the delayed sweep should be smaller than or equal to the main time base.



## Chapter 4 To Set the Sample System

Contents in this chapter:

- Timebase Mode
- Acquisition Mode
- Sampling Mode
- Sample Rate
- LA Sample Rate
- Memory Depth
- LA Memory Depth
- Anti-Aliasing
- Horizontal Expansion

## Timebase Mode

MSO5000 series supports three available time base modes: YT mode, XY mode, and ROLL mode. By default, the time base mode is YT.

Press **Acquire** → **Timebase Mode** on the front panel, and then rotate the multifunction knob  to select the desired time base mode. Then, press down the knob to select the mode. You can also press **Timebase Mode** continuously to select the mode or enable the touch screen to tap the desired mode and select it.

### YT Mode

In this mode, the Y axis represents voltage, and the X axis represents time.

**Note:** Only when this mode is enabled, can delayed sweep be turned on. In this mode, when the horizontal time base is equal to or greater than 200 ms/div, the instrument enters slow sweep mode. For details, refer to descriptions in "**ROLL Mode**".

### XY Mode

In this mode, both the X axis and the Y axis represent the voltage. The mode changes the display from voltage-time display mode to voltage-voltage display. You can use the Lissajous method to measure the phase deviation of the two input signals whose frequencies are the same. The following figure shows the measurement schematic diagram of phase deviation.

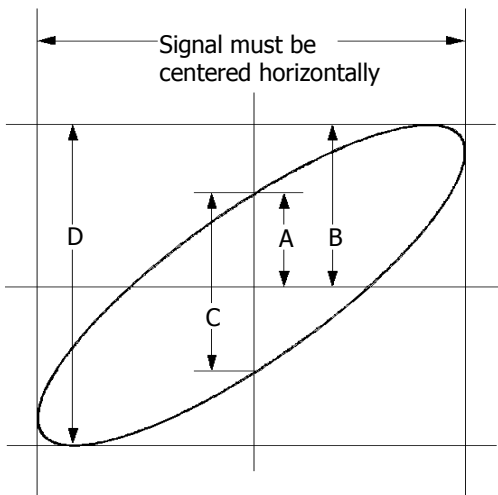

Figure 4-1 Measurement Schematic Diagram of Phase Deviation



According to  $\sin\theta=A/B$  or  $C/D$ ,  $\theta$  is the phase deviation angle between the two channels. The definitions of A, B, C, and D are shown in the above figure. The phase deviation angle is obtained, that is:



$$\theta=\pm\arcsin(A/B) \text{ or } \pm\arcsin(C/D)$$

If the principal axis of the ellipse is within Quadrant I and III, the phase deviation angle obtained should be within Quadrant I and IV, namely within  $(0 \text{ to } \pi/2)$  or  $(3\pi/2 \text{ to } 2\pi)$ . If the principal axis of the ellipse is within Quadrant II and IV, the phase deviation angle obtained should be within Quadrant II and III, namely within  $(\pi/2 \text{ to } \pi)$  or  $(\pi \text{ to } 3\pi/2)$ .

The XY function can be used to measure the phase deviation occurred when the signal under test passes through a circuit network. Connect the oscilloscope to the circuit to monitor the input and output signals of the circuit.

**Application example:** measures the phase deviation between the input signals of two channels.

### Use Lissajous method

1. Connect one sine signal to CH1, and then connect another sine signal (with the same frequency and amplitude as the previous one but a  $90^\circ$  phase deviation from the previous one) to CH2.
2. Press **AUTO**, after you select "XY" mode, rotate the **Horizontal**  **SCALE** to adjust the sample rate properly to obtain a better view of Lissajous graph for observation and measurement.
3. Rotate the **Vertical**  **SCALE** knob that corresponds to CH1 and CH2 respectively to make the signals easy to observe. Then, a circle, as shown in the figure below, should be displayed.

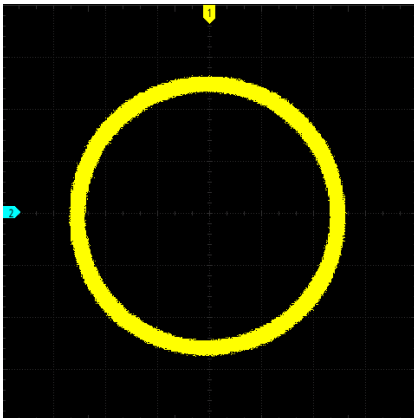

4. Observe the measurement result shown in the figure above. According to the measurement schematic diagram of the phase deviation (as shown in Figure 4-1),  $A/B(C/D)=1$ . Thus, the phase deviation angle of the two channel input signals is  $\theta=\pm\arcsin 1=90^\circ$ .

**Note:**

- In XY mode, CH1 and CH2 are forced to be enabled; CH3 and CH4 are forced to be disabled. The maximum sample rate in XY mode is 2 GSa/s. Generally, a longer sample waveform can ensure better display effect of Lissajous figure. But due to the limitation of the memory depth, you have to reduce the waveform sample rate to acquire a longer waveform (refer to the introduction in "**Memory Depth**"). Therefore, during the measurement, reducing the sample rate properly can achieve better display effect of Lissajous figure.
- The following functions are disabled in XY mode:  
**"Delayed Sweep", "Vector display", "Scale", "Protocol Decoding", "Acquisition Mode", "Pass/Fail Test", "Waveform Recording & Playing", "Digital Channel", and "To Set the Persistence Time".**

## ROLL Mode

In this mode, the waveform scrolls from right to left to update the display. The available range of the horizontal scale is from 200 ms to 1 ks. Press **More** → **Auto ROLL** to select "ON". The system automatically enters the ROLL mode, and there is no slow sweep.

**Note:**

- If the current delayed sweep is enabled, then when you enable the ROLL mode, the delayed sweep is disabled automatically. When you re-enable the "YT" mode, the delayed sweep will be re-enabled.
- The following functions cannot be set in ROLL mode:  
**"To Adjust the Horizontal Position"** (available when the oscilloscope is in "Stop" operating status), **"Delayed Sweep", "To Trigger the Oscilloscope", "Protocol Decoding", "Pass/Fail Test", "Waveform Recording & Playing", and "To Set the Persistence Time".**

### Slow Sweep

It is similar to the ROLL mode. In YT mode, when the horizontal time base is set to 200 ms/div or smaller, the instrument enters the "slow sweep" mode in which the instrument first acquires the data at the left of the trigger point and then waits for a trigger event. After the trigger occurs, the instrument continues to finish the waveform at the right of the trigger point. When observing the low-frequency signal in the slow sweep mode, it is recommended that you set "**Channel Coupling**" to "DC".

## Acquisition Mode

The acquisition mode is used to control how to generate waveform points from the sample points.

MSO5000 supports the following three acquisition modes: Normal, Average, and Peak. By default, the acquisition mode is Normal.

Press **Acquire** → **Acquisition** on the front panel, and then rotate the multifunction knob  to select the desired acquisition mode. Then, press down the knob to select the mode. You can also press **Acquisition** continuously to select the mode or enable the touch screen to tap the desired mode and select it.

### Normal

In this mode, the oscilloscope samples the signal at a specified fixed time interval to rebuild the waveform. For most of the waveforms, using this mode can produce the optimal display effects.

### Average

In this mode, the oscilloscope averages the waveforms from multiple samples to reduce the random noise of the input signal and improve the vertical resolution. Greater number of averages can lower the noise and increase the vertical resolution; while at the same time, it will slow the response of the displayed waveform to the waveform changes.

When you select "Average" mode, press **Averages** and rotate the multifunction knob  or use the numeric keypad to set the desired number of averages. You can also use the pop-up numeric keypad to input the average count. When the average count value is in power-of-2 increments, a prompt message "Trim average count" is displayed. At this time, a value that is smaller than the one you input and the closest to power-of-2 increments will be input automatically. For example, if you input 9 with the numeric keypad, the average count will be input 8 automatically.

The number of averages can be set to 2, 4, 8, 16, 32, 64, 128, 256, 512, 1024, 2048, 4096, 8192, 16384, 32768, or 65536. By default, it is 2.

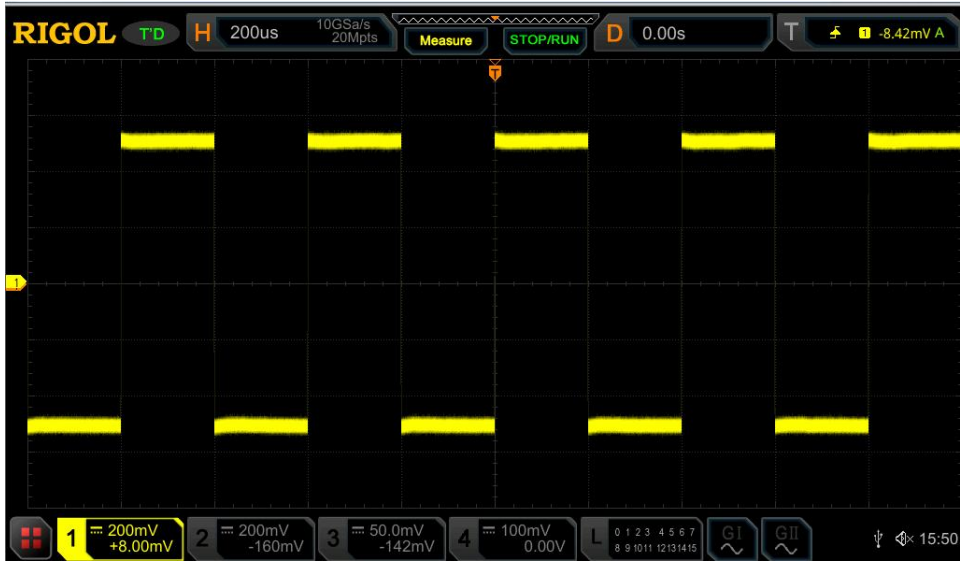

Figure 4-2 Waveforms before Averaging



Figure 4-3 Waveforms after 128 Times of Averaging

## Peak

In this mode, the oscilloscope acquires the maximum and minimum values of the signal within the sample interval to get the envelope of the signal or the narrow pulse that might be lost. In this mode, signal aliasing can be prevented, but the noise displayed would be larger.

In this mode, the oscilloscope can display all the pulses whose pulse widths are at

least the same as the sample period.

## Sampling Mode

This oscilloscope only supports the real-time sampling mode. In this mode, the oscilloscope produce the waveform display from samples collected during one trigger event. The highest real-time sample rate on the analog channel of MSO5000 series is 8 GSa/s. The current sample rate is displayed under **CH SampleRate**, and you can press **More** → **CH SampleRate** to view it.

### Tip

Press **RUN/STOP** on the front panel to stop sampling, and then the oscilloscope will maintain its last captured graph. You can still expand or zoom the waveforms by using the horizontal and vertical control knobs.

## Sample Rate

Sampling is the process of converting the analog signal into the digital signal at a specified time interval and then restoring them in sequence. The sample rate is the reciprocal of the time interval.

The sample rate of the analog channel is related to the current channel mode. The maximum real-time sample rate in the single-channel mode of the oscilloscope is 8 GSa/s. The maximum real-time sample rate in the half-channel mode is 4 GSa/s, and the maximum real-time sample rate in the all-channel mode is 2 GSa/s.

### Tip

Single-channel mode: only one of the four channels (CH1/CH2/CH3/CH4) is enabled.

Half-channel mode: either CH1 or CH2 is enabled; and either CH3 or CH4 is enabled.

All-channel mode: CH1/CH2 are both enabled or CH3/CH4 are both enabled.

**Note:** The sample rate is displayed both in the status bar at the upper part of the screen and in the **CH SampleRate** menu. To indirectly modify the sample rate, rotate the **Horizontal**  **SCALE** knob to adjust the horizontal time base or modify the memory depth.

The impact of low sample rate on the waveform:

**1. Waveform Distortion:** when the sample rate is too low, some waveform

details are lost, and the sample waveform displayed is rather different from the actual waveform of the signal.

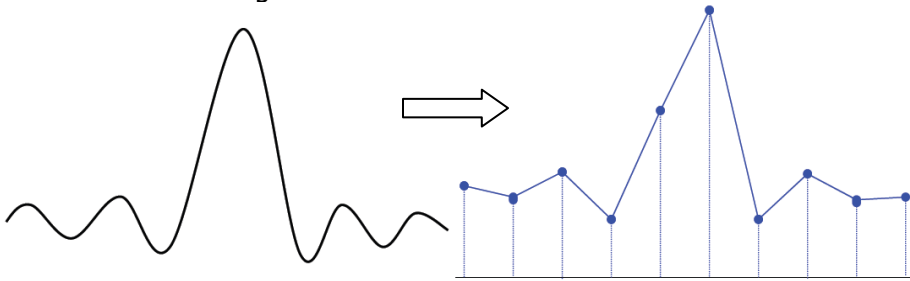

**2. Waveform Aliasing:** when the sample rate is twice lower than the actual signal frequency (Nyquist Frequency), the frequency of the waveform rebuilt from the sample data is smaller than the actual signal frequency.

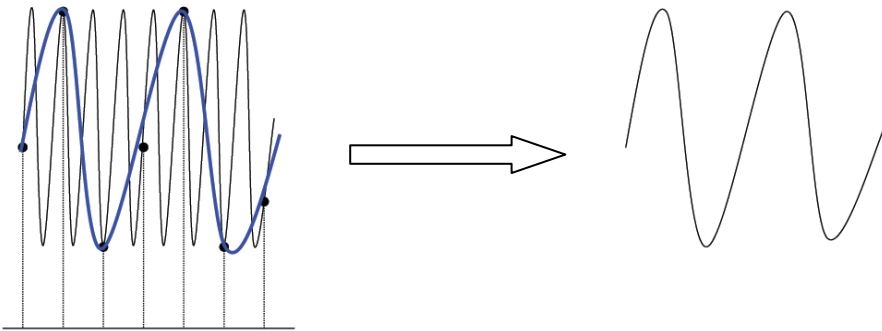

**3. Waveform Leakage:** when the sample rate is too low, the waveform rebuilt from the sample data does not reflect all the actual signal information.

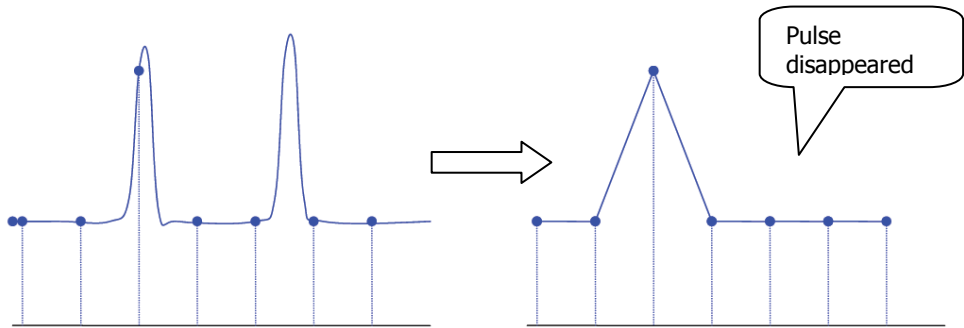

## LA Sample Rate

LA sampling is the process of sampling on the compared digital signals at a certain time interval. LA sample rate is the reciprocal of the time interval. For example, if the LA sample rate is 500 MSA/s, it indicates that the oscilloscope will make data

acquisition on the digital signals at an interval of 2 ns. The maximum LA sample rate of the oscilloscope is 1 GSa/s, and its display value is related to the sample rate of the current analog channel.

### Note:

- The digital signals here mentioned refers to the signal obtained from the comparison between the input signal and the user-defined threshold level. The rule of the comparison is that when the amplitude of the input signal is greater than the threshold level, it is judged to be the logic high level; when the amplitude of the input signal is smaller than the threshold level, it is judged to be the logic low level.
- LA sample rate is displayed under the **LA SampleRate** menu. To indirectly modify the LA sample rate, rotate the **Horizontal**  **SCALE** knob to adjust the horizontal time base or modify the memory depth.

## Memory Depth

Memory depth refers to the number of points of the oscilloscope that can store in one trigger acquisition. It reflects the storage capability of the acquisition storage. This oscilloscope is equipped with memory depth of up to 200 Mpts (option).

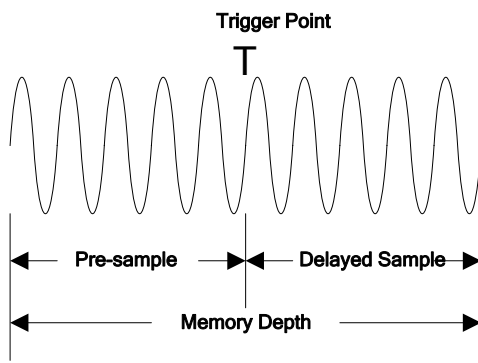

Figure 4-4 Memory Depth

The following equation shows the relations among memory depth, sample rate, and horizontal time base scale:

$$MDepth = SRate \times TScale \times HDivs$$

*MDepth* — indicates the memory depth. The unit is pts.

*SRate* — indicates the sample rate. The unit is Sa/s.

*TScale* — indicates the horizontal time base scale. The unit is s/div.

*HDivs* — indicates the number of grids in the horizontal direction. The unit is div.

Therefore, under the same horizontal time base scale, a higher memory depth can

ensure a higher sample rate.

Press **Acquire** → **Mem Depth**, then rotate the multifunction knob  to switch to the desired memory depth, and then press down the knob to select the option. You can also press the **Mem Depth** key continuously or enable the touch screen to select the memory depth. By default, the memory depth is Auto. The memory depth of the analog channel is related to the current channel mode.

- In single-channel mode, the memory depths available include Auto, 1 Kpts, 10 Kpts, 100 Kpts, 1 Mpts, 10 Mpts, 25 Mpts, 50 Mpts, 100 Mpts and 200 Mpts.
- In half-channel mode, the memory depths available include Auto, 1 Kpts, 10 Kpts, 100 Kpts, 1 Mpts, 10 Mpts, 25 Mpts, 50 Mpts and 100 Mpts.
- In all-channel mode, the memory depths available include Auto, 1 Kpts, 10 Kpts, 100 Kpts, 1 Mpts, 10 Mpts, 25 Mpts and 50 Mpts.

**Note:** In "Auto" mode, the oscilloscope selects the memory depth automatically according to the current sample rate.

## LA Memory Depth

Press **Acquire** → **More** to view the memory depth of the current digital channel under **LA Mem Depth**. The LA memory depth will change with the memory depth of the analog channel, and cannot be set separately. The maximum LA memory depth is 25 Mpts.

## Anti-Aliasing

At a slower sweep speed, the sample rate is reduced, and a dedicated display algorithm can be used to minimize the possibility of aliasing.



Press **Acquire** → **Anti-aliasing** to enable or disable the anti-aliasing function. By default, anti-aliasing is disabled. In this case, it is more likely to generate waveform aliasing.

**Note:** This function should be enabled when the horizontal time base has a large deviation from the period of the signal under test (e.g. when the horizontal time base is greater than five-fold the period of the signal under test).



## Horizontal Expansion

Horizontal expansion indicates the reference position that the screen waveform is referenced to when it is horizontally expanded or compressed in adjusting the



**Horizontal**  **SCALE** knob. In YT mode, press **Acquire** → **More** → **Expand** and then rotate the multifunction knob  to select the desired reference position. Press down the knob to select it. You can also press **Expand** continuously to select it or enable the touch screen to tap the desired reference. The horizontal expansion reference supported by the oscilloscope includes Center, Left, Right, Trigger, and User. The default is "Center".

- Center: when the horizontal time base is modified, the waveform will be expanded or compressed horizontally relative to the screen center.
- Left: when the horizontal time base is modified, the waveform will be expanded or compressed horizontally relative to the leftmost position of the screen.
- Right: when the horizontal time base is modified, the waveform will be expanded or compressed horizontally relative to the rightmost position of the screen.
- Trigger: when the horizontal time base is modified, the waveform will be expanded or compressed horizontally relative to the trigger point.
- User: when the horizontal time base is modified, the waveform displayed will be expanded or compressed horizontally relative to the user-defined reference position.

After you select "User", press **Expand User** and then rotate the multifunction knob  to set the expansion reference. Its available range is from the rightmost position of the screen to the leftmost position of the screen. By default, it is the screen center. Pressing down the multifunction knob  can quickly reset the user-defined reference position to 0.

**Note:** This function is unavailable in YT mode with the delayed sweep being enabled, XY mode, and ROLL mode.



## Chapter 5 To Trigger the Oscilloscope

As for trigger, you set certain trigger condition according to the requirement and when a waveform in the waveform stream meets this condition, the oscilloscope captures this waveform as well as the neighboring part, and displays them on the screen. For the digital oscilloscope, it samples waveform continuously no matter whether it is stably triggered, but only stable trigger can be stably displayed. The trigger module ensures that every time base sweep or acquisition starts from the user-defined trigger condition, namely every sweep is synchronous with the acquisition and the waveforms acquired is overlapped so as to display the stable waveforms.

Trigger settings should be based on the features of the input signal. To quickly capture the desired waveform, you need to understand the signal under test. This oscilloscope provides abundant trigger types that help you focus on the desired waveform details.

Contents in this chapter:

- Trigger Source
- Trigger LEVEL/Threshold Level
- Trigger Mode
- Trigger Coupling
- Trigger Holdoff
- Noise Rejection
- Trigger Type
- Zone Trigger
- Trigger Output Connector

## Trigger Source

In the trigger control area (Trigger) on the front panel, press **Menu** → **Source** to select the desired source, or rotate the multi-function knob  to select a desired source, then press down the knob to select it. You can also press **Source** continuously to select the trigger source or enable the touch screen to tap the desired trigger source and select it.

Analog channels (CH1-CH4), digital channels (D0-D15), or AC Line can all be selected as the trigger source.

### **Analog channel input:**

Signals input from analog channels CH1-CH4 can all be used as trigger sources. No matter whether the channel selected is enabled, the channel can work normally.

### **Digital channel input:**

Signals input from digital channels D0-D15 can all be used as trigger sources. No matter whether the channel selected is enabled, the channel can work normally.

### **AC line input:**

The trigger signal is obtained from the AC power input of the oscilloscope. AC trigger is usually used to measure signals relevant to the AC power frequency. For example, stably triggering the waveform output from the transformer of a transformer substation. It is mainly used in related measurements of the power industry.

## Trigger LEVEL/Threshold Level

The adjustment of the trigger level/threshold level is related to the type of the trigger source.

- When the trigger source is selected from CH1 to CH4, rotate the **Trigger LEVEL** knob to adjust the trigger level. During the adjustment, a trigger level line (the color of the trigger level line should be consistent with that of the channel color) and a trigger label "T" are displayed on the screen, and they move up and down with the variation of the trigger level. When you stopping modifying the trigger level, the trigger level line disappears in about 2 s. The current trigger level value is displayed at the upper-right corner of the screen.

**Note:** In Runt Trigger, Slope Trigger, and Window trigger, you need to set the upper and lower limits of the trigger level. You can modify the level by rotating the **Trigger LEVEL** knob. The difference between the current upper limit and lower limit of the trigger level is displayed at the upper-right side of the screen. Two trigger level labels (H and L) are displayed at the left side of the screen. Meanwhile, the real-time trigger level information is displayed at the lower-left side of the screen, as shown in the figure below. H indicates the upper limit of the trigger level, L indicates the lower limit of the trigger level, and  $\Delta$  indicates the deviation of the trigger level.





- When the trigger source is AC Line, there is no trigger level.
- When the trigger source is selected from D0 to D15, rotate the **Trigger LEVEL** knob to adjust the threshold level. The current threshold level value is displayed at the upper-right corner of the screen. In addition, you can also press **LA** to enter the LA logic analysis setting menu. Then set the threshold level of the digital channel in the sub-menu threshold setting. For the setting method, refer to "**To Set the Threshold**".

You can also enable the touch screen function to adjust the trigger level/threshold level. Two methods are available for you:

Method 1: Enable the touch screen and drag the trigger level line to adjust the trigger level. For details about the operations, refer to descriptions in "**Drag**" section.

Method 2: Enable the touch screen function, and tap the trigger setting label

 at the upper-right corner of the screen. The following window is displayed. Tap the   icon at the right side of the **Level** input field to decrease or increase the trigger level. You can also tap the **Level** input field to

input a specific value with the displayed numeric keypad.

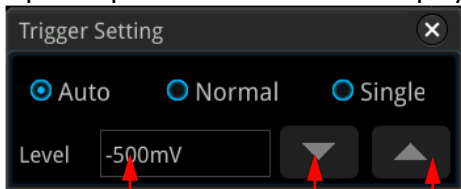

Level Input Field

Decrease the level Increase the level

## Trigger Mode

The following is the schematic diagram of the acquisition memory. To easily understand the trigger event, we classify the acquisition memory into the pre-trigger buffer and post-trigger buffer.

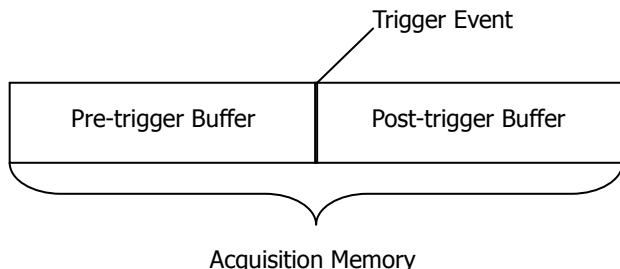

Figure 5-1 Schematic Diagram of the Acquisition Memory

After the system runs, the oscilloscope operates by first filling the pre-trigger buffer. It starts searching for a trigger after the pre-trigger buffer is filled. While searching for the trigger, the data sampled will still be transmitted to the pre-trigger buffer (the new data will continuously overwrite the previous data). When a trigger is found, the pre-trigger buffer contains the data acquired just before the trigger. Then, the oscilloscope will fill the post-trigger buffer and display the data in the acquisition memory. If the acquisition is activated via **RUN/STOP**, the oscilloscope will repeat this process; if the acquisition is activated via **SINGLE**, the oscilloscope will stop after finishing a single acquisition (you can pan and zoom the currently displayed waveform).

MSO5000 provides three trigger modes: Auto, Normal, and Single. The default is Auto.

In the trigger control area (Trigger) on the front panel, press **Mode** to quickly switch the current trigger mode. The trigger mode is displayed at the upper-right corner of the screen: A (Auto), N (Normal), and S (Single).

- Auto: In this trigger mode, if the specified trigger conditions are not found, triggers

are forced and acquisitions are made so as to display the waveforms. This trigger mode should be used when the signal level is unknown or the DC should be displayed as well as when forcible trigger is not necessary as the trigger condition always occurs.

- Normal: In this trigger mode, triggers and acquisitions only occur when the specified trigger conditions are found. This trigger mode should be used when the signal is with low repetition rate or only the event specified by the trigger setting needs to be sampled as well as when auto trigger should be prevented to acquire stable display.
- Single: In this trigger mode, the oscilloscope performs a single trigger and acquisition when the specified trigger conditions are found, and then stops. This trigger mode should be used when you need to perform a single acquisition of the specified event and analyze the acquisition result (you can pan and zoom the currently displayed waveform, and the subsequent waveform data will not overwrite the current waveform). After a single trigger mode is initiated, the operating status of the oscilloscope is in "STOP" state.

**Note:** In "Normal" and "Single" trigger modes, pressing **Force** can generate a trigger signal forcibly.

In addition, you can enable the touch screen to set the trigger mode. Enable the touch screen and tap the trigger setting label  at the upper-right corner of the screen. Then the following window is displayed. Tap to select "Auto", "Normal", or "Single" as the trigger mode.

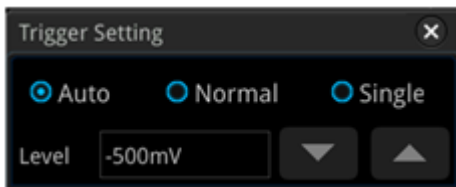

## Trigger Coupling

Trigger coupling decides which kind of components will be transmitted to the trigger module. Please distinguish it from "**Channel Coupling**".

**Note:** Trigger coupling is only valid when the trigger type is Edge and the trigger source is an analog channel.

Press **Menu** → **Coupling** in the trigger control area (Trigger) on the front panel. Then, rotate the multifunction knob  to select the desired coupling mode (by default, it is DC). You can also press **Coupling** continuously to select it or enable the touch screen to select the desired coupling mode with touch gestures.

- DC: allows DC and AC components to pass the trigger path.

- AC: blocks the DC components and attenuates signals.
- LFR: blocks the DC components and rejects the low-frequency components.
- HFR: rejects the high frequency components.

**Tip**  
When "AC" or "LFR" is selected under **Coupling**, no trigger level lines and trigger icons are displayed. When you adjust the trigger level, you can only see the changes of the trigger level values at the upper-right corner of the screen.

## Trigger Holdoff

Trigger holdoff can be used to stably trigger on complex repetitive waveforms that have multiple edges (or other events) between waveform repetitions (such as pulse series). Holdoff time indicates the time that the oscilloscope waits for re-arming the trigger module after generating a correct trigger. The oscilloscope will not trigger even if the trigger condition is met during the holdoff time and will only re-arm the trigger module after the holdoff time expires.

For example, to stably trigger the repetitive pulse series as shown in the figure below, the holdoff time should be set to a value that is greater than  $t_1$  and smaller than  $t_2$ .

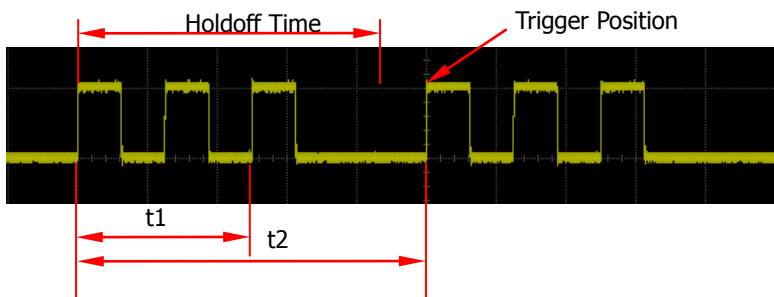



Figure 5-2 Schematic Diagram of Trigger Holdoff

In the trigger control area (Trigger) on the front panel, press **Menu** → **Holdoff** (for some triggers, **Holdoff** is a sub menu under **More**, at this time, press **Menu** → **More** → **Holdoff**) and then rotate the multifunction knob  at a small step to modify the holdoff time (the holdoff to this time when the waveforms are stably triggered; by default, the holdoff time is 16 ns). Also, you can use the numeric keypad to set the holdoff time. The adjustable range of holdoff time is from 8 ns to 10 s.



## Noise Rejection

Noise rejection can reject the high frequency noise in the signal and reduce the possibility of miss-trigger of the oscilloscope.

In the trigger control area (Trigger) on the front panel, press **Menu** to enter the trigger setting menu, then press **Noise Reject** continuously (for some triggers, **Noise Reject** is a sub menu under **More**, at this time, press **Menu** → **More** → **Noise Reject**) to enable or disable noise rejection.

**Note:** This function is only available when the trigger source is an analog channel.

## Trigger Type

MSO5000 series oscilloscope provides the following trigger types.

- Edge Trigger
- Pulse Trigger
- Slope Trigger
- Video Trigger
- Pattern Trigger
- Duration Trigger
- Timeout Trigger
- Window Trigger
- Delay Trigger
- Setup/Hold Trigger
- Nth Edge Trigger
- RS232 Trigger (Option)
- I2C Trigger (Option)
- SPI Trigger (Option)
- CAN Trigger (Option)
- FlexRay Trigger (Option)
- LIN Trigger (Option)
- I2S Trigger (Option)
- MIL-STD-1553 Trigger (Option)

## Edge Trigger

Triggers on the trigger level/threshold level of the specified edge of the input signal.

### Trigger Type:

Press **Menu** → **Type** in the trigger control area (Trigger) on the front panel and rotate the multifunction knob  to select "Edge", then press down the knob to select it. You can also press **Type** continuously or enable the touch screen to tap the desired trigger type and select it. At this time, the current trigger setting information (including trigger type, trigger source, and trigger level/threshold level) is displayed at the upper-right corner of the screen, as shown in the figure below. The information will change based on the trigger settings.







### Source Selection:

Press **Source** to open the signal source list and select CH1-CH4, AC Line, or D0-D15. For details, refer to descriptions in "**Trigger Source**". The current trigger source is displayed at the upper-right corner of the screen.

**Note:** Only when we select the channel (that has been input with signals) as the trigger source, can we obtain a stable trigger.

### Edge Type:

Press **Slope**, and then rotate the multifunction knob  to select the input signal the edge on which the oscilloscope triggers. Then, the current edge type is displayed at the upper-right corner of the screen. You can also press the **Slope** key continuously or enable the touch screen to select the desired edge type.

-  Rising: triggers on the rising edge of the input signal when the voltage level meets the specified trigger level.
-  Falling: triggers on the falling edge of the input signal when the voltage level meets the specified trigger level.
-  Either: triggers on the rising or falling edge of the input signal when the voltage level meets the preset trigger level.

### Trigger Mode:

In the trigger control area (Trigger) on the front panel, press **Mode** to quickly switch the current trigger mode. For details, refer to descriptions in "**Trigger Mode**".

### Trigger Parameter Setting:

Set the trigger parameters (trigger coupling, trigger holdoff, and noise rejection) under this trigger type. For details, refer to descriptions in "**Trigger Coupling**", "**Trigger Holdoff**", and "**Noise Rejection**".

### Trigger LEVEL/Threshold Level:

Rotate the **Trigger**  **LEVEL** knob to adjust the trigger level or threshold level.

Please refer to descriptions in "**Trigger LEVEL/Threshold Level**". The current trigger level/threshold level value is displayed at the upper-right corner of the screen.

## Pulse Trigger

Triggers on the positive or negative pulse with a specified width. In this mode, the oscilloscope will trigger when the pulse width of the input signal satisfies the specified pulse width condition.

In this oscilloscope, positive pulse width is defined as the time difference between the two crossing points of the trigger level and positive pulse; negative pulse width is defined as the time difference between the two crossing points of the trigger level and negative pulse, as shown in the figure below.

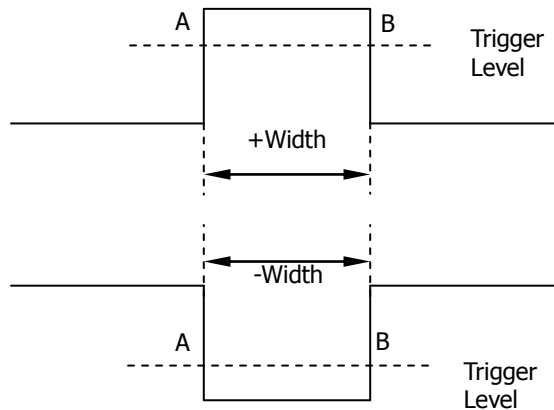



Figure 5-3 Positive Pulse Width/Negative Pulse Width

### Trigger Type:

Press **Type**, and then rotate the multifunction knob  to select "Pulse". Press down the knob to select the trigger type. Then, the current trigger setting information is displayed at the upper-right corner of the screen, as shown in the figure below. You can also press the **Type** key continuously or enable the touch screen to select the desired trigger type.



### Source Selection:

Press **Source** to open the signal source list and select CH1-CH4 or D0-D15. For details, refer to descriptions in "**Trigger Source**". The current trigger source is displayed at the upper-right corner of the screen.

**Note:** Only when we select the channel (that has been input with signals) as the trigger source, can we obtain a stable trigger.

**Polarity:**



Press **Polarity** continuously to select the desired polarity. The polarities available are positive polarity (▮▮) and negative polarity (▮▮).

**Trigger Condition:**

Press **When**, then rotate the multifunction knob  to select the trigger condition, and then press down the knob to select the trigger condition. You can also press **When** continuously to select the trigger condition or enable the touch screen to tap the desired trigger condition and select it.

- When you select "Positive" for polarity, ">" for trigger condition, the oscilloscope triggers when the positive pulse width of the input signal is greater than the specified pulse width.
- When you select "Positive" for polarity, "<" for trigger condition, the oscilloscope triggers when the positive pulse width of the input signal is smaller than the specified pulse width.
- When you select "Positive" for polarity, "<>" for trigger condition, the oscilloscope triggers when the positive pulse width of the input signal is greater than the specified lower limit of pulse width and smaller than the specified upper limit of pulse width.
- When you select "Negative" for polarity, ">" for trigger condition, the oscilloscope triggers when the negative pulse width of the input signal is greater than the specified pulse width.
- When you select "Negative" for polarity, "<" for trigger condition, the oscilloscope triggers when the negative pulse width of the input signal is smaller than the specified pulse width.
- When you select "Negative" for polarity, "<>" for trigger condition, the oscilloscope triggers when the negative pulse width of the input signal is greater than the specified lower limit of pulse width and smaller than the specified upper limit of pulse width.

**Pulse Width Setting:**

- When ">" or "<" is set to the trigger condition, press **Lower** or **Upper**, and then rotate the multifunction knob to set the desired value; or press down the multifunction knob  to set the lower limit value or the upper limit value. You can also use the pop-up numeric keypad to set it. The pulse range available is from 800 ps to 10 s.
- When "<>" is set to the trigger condition, press **Upper** and **Lower**, and then rotate the multifunction knob  to set the lower limit value and the upper limit value. You can also use the pop-up numeric keypad to set them.

**Note:** The lower limit of the pulse width must be smaller than the upper limit.

**Trigger Mode:**

In the trigger control area (Trigger) on the front panel, press **Mode** to quickly switch the current trigger mode. For details, refer to descriptions in "**Trigger Mode**".

**Trigger Parameter Setting:**

Set the trigger parameters (trigger holdoff and noise rejection) under this trigger type. For details, refer to descriptions in "**Trigger Holdoff**" and "**Noise Rejection**".

**Trigger LEVEL/Threshold Level:**

Rotate the **Trigger**  **LEVEL** knob to adjust the trigger level or threshold level. Please refer to descriptions in "**Trigger LEVEL/Threshold Level**". The current trigger level/threshold level value is displayed at the upper-right corner of the screen.

**Slope Trigger**

In Slope trigger, the oscilloscope triggers on the positive or negative slope of the specified time. This trigger mode is applicable to ramp and triangle waveforms.

In this oscilloscope, positive slope time is defined as the time difference between the two crossing points of trigger level line A and B with the rising edge; negative slope time is defined as the time difference between the two crossing points of trigger level line A and B with the falling edge, as shown in the figure below.

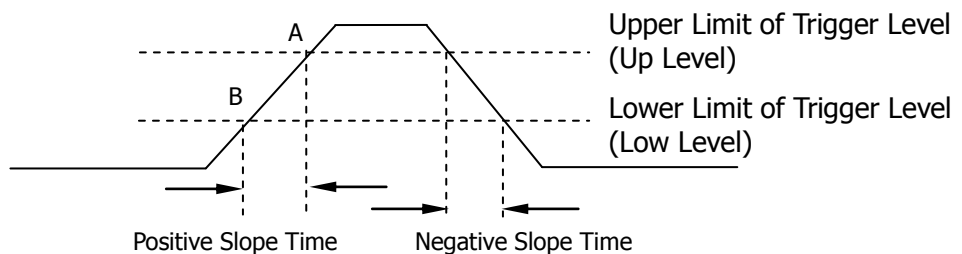



Figure 5-4 Positive Slope Time/Negative Slope Time

**Trigger Type:**

Press **Type**, and then rotate the multifunction knob  to select "Slope". Press down the knob to select the trigger type. Then, the current trigger setting information is displayed at the upper-right corner of the screen, as shown in the figure below. You can also press **Type** continuously or enable the touch screen to tap the desired trigger type and select it.



**Source Selection:**

Press **Source** to switch the trigger source and select CH1-CH4. For details, refer to descriptions in "**Trigger Source**". The current trigger source is displayed at the upper-right corner of the screen.

**Note:** Only when we select the channel (that has been input with signals) as the trigger source, can we obtain a stable trigger.

**Edge Type:**

Press **Slope** continuously to select the input signal edge on which the oscilloscope triggers.



-  Rising: triggers on the rising edge of the input signal.
-  Falling: triggers on the falling edge of the input signal.

**Slope Condition:**

Press **When**, then rotate the multifunction knob  to select the trigger condition, and then press down the knob to select the trigger condition. You can also press **When** continuously to select the trigger condition or enable the touch screen to tap the desired trigger condition and select it.

- When you select "Rising" for the edge type, ">" for trigger condition, the oscilloscope triggers when the positive slope time of the input signal is greater than the specified time.
- When you select "Rising" for the edge type, "<" for trigger condition, the oscilloscope triggers when the positive slope time of the input signal is smaller than the specified time.
- When you select "Rising" for the edge type, "<>" for trigger condition, the oscilloscope triggers when the positive slope time of the input signal is greater than the specified lower limit time and smaller than the specified upper limit time.
- When you select "Falling" for the edge type, ">" for trigger condition, the oscilloscope triggers when the negative slope time of the input signal is greater than the specified time.
- When you select "Falling" for the edge type, "<" for trigger condition, the oscilloscope triggers when the negative slope time of the input signal is smaller than the specified time.
- When you select "Falling" for the edge type, "<>" for trigger condition, the oscilloscope triggers when the negative slope time of the input signal is greater than the specified lower limit time and smaller than the specified upper limit time.

**Slope Time Setting:**

- When ">" or "<" is set to trigger condition, press **Lower** or **Upper**, and then rotate the multifunction knob  to set the lower limit value or the upper limit value. You can also use the pop-up numeric keypad to set it. The available range of the slope time is from 800 ps to 10 s.
- When "<>" is set to trigger condition, press **Upper** and **Lower**, and then rotate the multifunction knob  to set the upper limit value and the lower limit value. You can also use the pop-up numeric keypad to set them.

**Note:** The lower slope time limit must be smaller than the upper slope time limit.

**Level Selection and Adjustment of Trigger Level:**

After the trigger condition setting is completed, you need to adjust the trigger level

to correctly trigger the signal and obtain a stable waveform. Press **Level Select** (when "<>" is selected as the trigger condition, **Level Select** is a sub-menu under **More**), then rotate the multifunction knob  to select the desired level type for adjustment, and then press down the knob to select the type. You can also press **Level Select** continuously to select the level type or enable the touch screen to tap the desired level type and select it.

- Level A: only adjusts the upper limit of the trigger level, and the lower limit of the trigger level remains unchanged.
- Level B: only adjusts the lower limit of the trigger level, and the upper limit of the trigger level remains unchanged.
- Level AB: adjusts the upper and lower limits of the trigger level at the same time, and the trigger level deviation (the difference between the upper limit and lower limit of the trigger level) remains unchanged.

**Note:** In Slope trigger, pressing **Trigger**  **LEVEL** can quickly switch the current level adjustment type.

Rotate the **Trigger**  **LEVEL** knob to adjust the corresponding trigger level. During the adjustment of trigger level, two trigger level lines appear on the screen, and they move up and down with the change of the trigger level. At the same time, the real-time trigger level information is displayed at the lower-left corner of the screen (as shown in the figure below, H indicates the upper limit of the trigger level, L indicates the lower limit of the trigger level, and  $\Delta$  indicates the trigger level deviation). When you stop modifying the trigger level, the trigger level line and the trigger level information at the lower-left corner of the screen disappear in about 2 s. The current trigger level deviation is displayed at the upper-right corner of the screen.

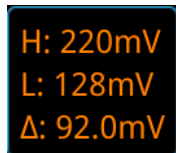

H: 220mV  
L: 128mV  
 $\Delta$ : 92.0mV

### Trigger Mode:

In the trigger control area (Trigger) on the front panel, press **Mode** to quickly switch the current trigger mode. For details, refer to descriptions in "**Trigger Mode**".

### Trigger Parameter Setting:

Set the trigger parameters (trigger holdoff and noise rejection) under this trigger type. For details, refer to descriptions in "**Trigger Holdoff**" and "**Noise Rejection**".

## Video Trigger

The video signal can include image information and timing information, which adopts different standards and formats. MSO5000 series can trigger on the standard video signal field or line of NTSC (National Television Standards Committee), PAL (Phase Alternating Line), or SECAM (Sequential Couleur A Memoire).

### Trigger Type:

Press **Type**, and then rotate the multifunction knob  to select "Video". Press down the knob to select the trigger type. Then, the current trigger setting information is displayed at the upper-right corner of the screen, as shown in the figure below. You can also press **Type** continuously or enable the touch screen to tap the desired trigger type and select it.





### Source Selection:

Press **Source** to switch the trigger source and select CH1-CH4. For details, refer to descriptions in "**Trigger Source**". The current trigger source is displayed at the upper-right corner of the screen.

**Note:** Only when we select the channel (that has been input with signals) as the trigger source, can we obtain a stable trigger.

### Video Polarity:

Press **Polarity** continuously to select the desired video polarity. The polarities available are positive polarity () and negative polarity ()

### Video Standard:

Press **Standard** and rotate the multifunction knob  to select the desired video standard. You can also press **Standard** continuously to select the video standard or enable the touch screen to tap the desired video standard and select it.

- NTSC: indicates that the field frequency is 60 fields per second, and the frame frequency is 30 frames per second. The TV scan line is 525, with the even field going first and the odd field following behind.
- PAL/SECAM:
  - PAL: indicates that the frame frequency is 25 frames per second. The TV scan line is 625, with the odd field going first and the even field following behind.
  - SECAM: indicates that the frame frequency is 25 frames per second. The TV scan line is 625 with interlaced scan.
- 480P: indicates that the frame frequency is 60 frames per second. The TV scan line is 525, with progressive scan; the line frequency is 31.5 kHz.
- 576P: indicates that the frame frequency is 60 frames per second. The TV scan line is 625; with progressive scan.



**Sync:**

Press **Sync**, then rotate the multifunction knob  to select the sync type, and then press down the knob to select the type. You can also press **Sync** continuously to select the sync type or enable the touch screen to tap the desired sync type and select it.

- All Lines: triggers on the first line found.
- Line: for NTSC and PAL/SECAM video standards, trigger on the specified line. When this sync type is selected, you can specify a line number. Press **Line**, then rotate the multifunction knob  or use the pop-up numeric keypad to modify the line number. The range of the line number is related to the currently selected video standards. The range is from 1 to 525 (NTSC), 1 to 625 (PAL/SECAM), 1 to 525 (480P), and 1 to 625 (576P).
- Odd: triggers on the rising edge of the first ramp pulse in the odd field.
- Even: triggers on the rising edge of the first ramp pulse in the even field.

**Noise Rejection:**

Set the trigger parameter (noise rejection) under this trigger type. For details, refer to descriptions in "**Noise Rejection**".

**Trigger Mode:**

In the trigger control area (Trigger) on the front panel, press **Mode** to quickly switch the current trigger mode. For details, refer to descriptions in "**Trigger Mode**".

**Trigger Setting:**

Press **Noise Reject** to set the trigger parameter (noise rejection) under this trigger type. For details, refer to descriptions in "**Noise Rejection**".

**Trigger Level:**

Use **Trigger**  **LEVEL** to modify the level. For details, refer to descriptions in "**Trigger LEVEL/Threshold Level**".

**Tip**

- For a better observation of the waveform details in the video signal, you can set a larger memory depth first.
- In the trigger debugging process of video signals, the frequency in different part of the signal can be reflected by a different brightness, as **RIGOL** digital oscilloscope provides the intensity graded color display function. Experienced users can quickly judge the signal quality and discover abnormalities during the debugging process.

## Pattern Trigger

Identifies a trigger condition by searching for a specified pattern. This pattern is a logical "AND" combination of channels. Each channel can be set to H (high), L (low), or X (don't care). A rising or falling edge (you can only specify a single edge) can be specified for one channel included in the pattern. When an edge is specified, the oscilloscope will trigger at the edge specified if the pattern set for the other channels are true (namely the actual pattern of the channel is the same as the preset pattern). If no edge is specified, the oscilloscope will trigger on the last edge that makes the pattern true. If all the channels in the pattern are set to "X", the oscilloscope will not trigger.

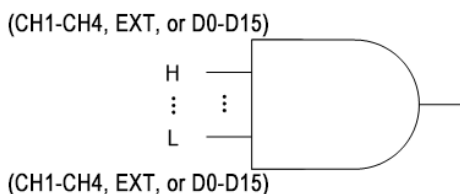



Figure 5-5 Pattern Trigger

### Trigger Type:

Press **Type**, and then rotate the multifunction knob  to select "Pattern". Press down the knob to select the trigger type. Then, the current trigger setting information is displayed at the upper-right corner of the screen, as shown in the figure below. You can also press **Type** continuously to select the trigger type or enable the touch screen to tap the desired trigger type and select it.

T Pat 1 0.00V

### Source Selection:

Press **Source** to open the signal source list and select CH1-CH4 or D0-D15. For details, refer to descriptions in "**Trigger Source**". The current trigger source is displayed at the upper-right corner of the screen.





**Note:** Only when we select the channel (that has been input with signals) as the trigger source, can we obtain a stable trigger.

### Pattern Setting:

Press **Code**, and rotate the multifunction knob  to select the pattern of the currently selected channel. Press down the knob to select the pattern. You can also press **Code** continuously to select the pattern or enable the touch screen to select it. The available patterns include the following five types:

- H: sets the pattern of the channel selected to "1", i.g. the voltage level is higher than the trigger level/threshold level of the channel.
- L: sets the pattern of the channel selected to "0", i.g. the voltage level is lower than the trigger level/threshold level of the channel.
- X: sets the pattern of the channel selected to "X", i.g. this channel is not used as

a part of the pattern. When all channels in the pattern are set to "X", the oscilloscope will not trigger.

-  Rising: sets the pattern to the rising edge () of the channel selected.
-  Falling: sets the pattern to the falling edge () of the channel selected.

The corresponding pattern is displayed at the bottom of the screen. The patterns of channels CH1-CH4 and D0-D15 are presented from left to right, as shown in the figure below.



You can also set the pattern with the virtual keypad. The setting methods are as follows:



Enable the touch screen to tap the channel pattern. Then, a virtual keypad is displayed. Set the channel pattern with the keypad. For example, tap CH2 pattern, then the virtual keypad for setting the channel pattern is displayed, as shown in Figure 5-6. Tap the left arrow key  to move the cursor to the left or tap the right arrow key  to move the cursor to the right. Then select a pattern. After the pattern of the current channel is set completely, the cursor goes to the next pattern bit automatically. Set them respectively. After all the pattern bits are set completely, tap **OK** to confirm the setting, and close the virtual keypad. You can also tap **All** to apply the current pattern to all the channels. This key function the same as the **All Bits** menu key.



Figure 5-6 Virtual Keypad for Pattern Setting

**Note:** Only one edge (rising or falling edge) can be specified in the pattern. If one edge item is currently defined and then another edge item is defined in another channel in the pattern, then a prompt message "Invalid input" is displayed. Then the latter defined edge item will be replaced by X.

**All Bits:**

Press **All Bits** to set the patterns of all channels to the currently selected pattern.

**Trigger Mode:**

In the trigger control area (Trigger) on the front panel, press **Mode** to quickly switch the current trigger mode. For details, refer to descriptions in **"Trigger Mode"**.

**Trigger Parameter Setting:**

Set the trigger parameters (trigger holdoff and noise rejection) under this trigger type. For details, refer to descriptions in **"Trigger Holdoff"** and **"Noise Rejection"**.

**Trigger LEVEL/Threshold Level:**

Rotate the **Trigger**  **LEVEL** knob to adjust the trigger level/threshold level. Refer to **"Trigger LEVEL/Threshold Level"**. The current trigger level/threshold level value is displayed at the upper-right corner of the screen.

**Duration Trigger**

In duration trigger, the instrument identifies a trigger condition by searching for the duration of a specified pattern. This pattern is a logical "AND" combination of the channels. Each channel can be set to H (high), L (low), or X (don't care). You can specify a channel in the pattern to be the rising or falling edge (only one edge can be specified). When the duration ( $\Delta T$ ) of this pattern meets the preset time, the oscilloscope initiates a trigger, as shown in the figure below.

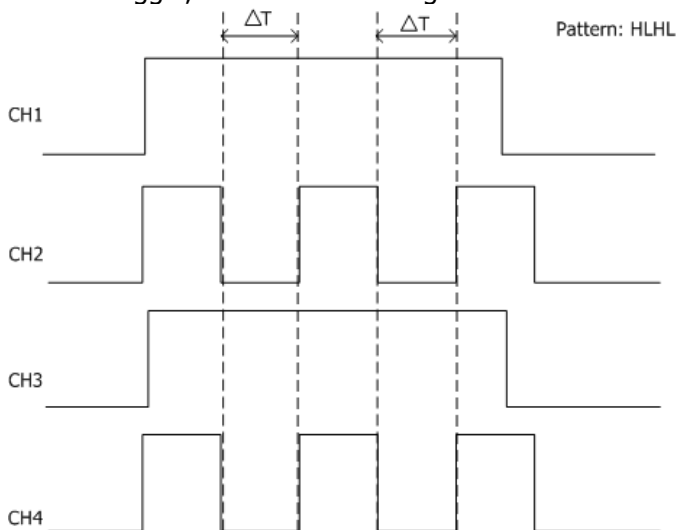

Figure 5-7 Duration Trigger

**Trigger Type:**

Press **Type**, and then rotate the multifunction knob  to select "Duration". Press down the knob to select the trigger type. Then, the current trigger setting information is displayed at the upper-right corner of the screen, as shown in the

figure below. You can also press **Type** continuously to select the trigger type or enable the touch screen to tap the desired trigger type and select it.



### Source Selection:

Press **Source** to open the signal source list and select CH1-CH4 or D0-D15. For details, refer to descriptions in "**Trigger Source**". The current trigger source is displayed at the upper-right corner of the screen.

**Note:** Only when we select the channel (that has been input with signals) as the trigger source, can we obtain a stable trigger.

### Pattern Setting:

Press **Code**, and rotate the multifunction knob  to select the pattern of the currently selected channel. Press down the knob to select the pattern. The corresponding pattern is displayed at the bottom of the screen. The patterns of channels CH1-CH4 and D0-D15 are presented from left to right, as shown in the figure below. You can also press **Code** continuously to select the pattern or enable the touch screen to select it.



- H: sets the pattern of the channel selected to "H", i.g. the voltage level is higher than the trigger level/threshold level of the channel.
- L: sets the pattern of the channel selected to "L", i.g. the voltage level is lower than the trigger level/threshold level of the channel.
- X: sets the pattern of the channel selected to "X", i.g. this channel is not used as a part of the pattern. When all channels in the pattern are set to "X", the oscilloscope will not trigger.

### Trigger Condition:

Press **When**, then rotate the multifunction knob  to select the trigger condition, and then press down the knob to select the trigger condition. You can also press **When** continuously to select the trigger condition or enable the touch screen to tap the desired trigger condition and select it.

- >: triggers when the duration of the pattern is greater than the preset time. Press **Lower** to set the lower limit of the duration of the pattern. Its range is from 800 ps to 10 s.
- <: triggers when the duration of the pattern is smaller than the preset time. Press **Upper** to set the upper limit of the duration of the pattern. Its range is from 800 ps to 10 s.
- <>: triggers when the duration of the pattern is smaller than the upper limit of the preset time and greater than the lower limit of the preset time. Press **Upper** to set the upper limit of the duration of the pattern, and the range is from 1.2 ns to 10 s. Press **Lower** to set the lower limit of the duration of the pattern, and the range is from 800 ps to 10 s.

- **><**: triggers when the duration of the pattern is greater than the upper limit of the preset time and smaller than the lower limit of the preset time. Press **Upper** to set the upper limit of the duration of the pattern, and the range is from 800 ps to 10 s. Press **Lower** to set the lower limit of the duration of the pattern, and the range is from 800 ps to 9.99 s.

**Note:** The lower time limit must be smaller than the upper time limit.

#### All Bits:

Press **All Bits** to set the pattern of all trigger sources to the pattern setting selected currently.

#### Trigger Mode:

In the trigger control area (Trigger) on the front panel, press **Mode** to quickly switch the current trigger mode. For details, refer to descriptions in "**Trigger Mode**".

#### Trigger Parameter Setting:

Set the trigger parameters (trigger holdoff and noise rejection) under this trigger type. For details, refer to descriptions in "**Trigger Holdoff**" and "**Noise Rejection**".

#### Trigger LEVEL/Threshold Level:

Rotate the **Trigger**  **LEVEL** knob to adjust the trigger level/threshold level. Refer to "**Trigger LEVEL/Threshold Level**". The current trigger level/threshold level value is displayed at the upper-right corner of the screen.

## Timeout Trigger

In Timeout trigger, the oscilloscope triggers when the time interval ( $\Delta T$ ) (the time from when the rising edge (or falling edge) of the input signal passes through the trigger level to the time from when the neighboring falling edge (or rising edge) passes through the trigger level) is greater than the preset timeout value, as shown in the figure below.

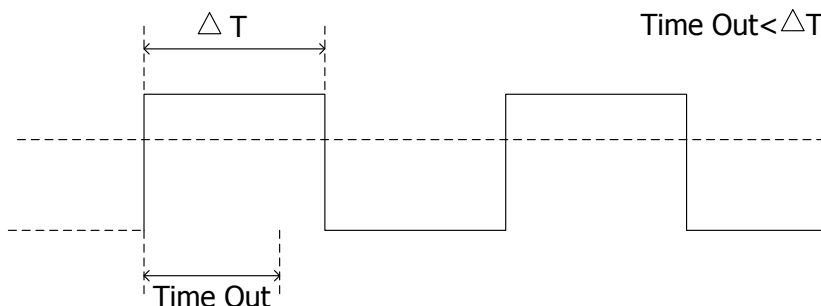



Figure 5-8 Timeout Trigger

**Trigger Type:**

Press **Type**, and then rotate the multifunction knob  to select "Timeout". Press down the knob to select the trigger type. Then, the current trigger setting information is displayed at the upper-right corner of the screen, as shown in the figure below. You can also press **Type** continuously to select the trigger type or enable the touch screen to tap the desired trigger type and select it.



**Source Selection:**

Press **Source** to open the signal source list and select CH1-CH4 or D0-D15. For details, refer to descriptions in "**Trigger Source**". The current trigger source is displayed at the upper-right corner of the screen.

**Note:** Only when we select the channel (that has been input with signals) as the trigger source, can we obtain a stable trigger.

**Edge Type:**

Press **Slope** and rotate the multifunction knob  to select the edge type of the input signal that starts to pass through the trigger level. You can also press **Slope** continuously to enable the touch screen to select the edge type.

-  Rising: starts timing when the rising edge of the input signal passes through the trigger level.
-  Falling: starts timing when the falling edge of the input signal passes through the trigger level.
-  Either: starts timing when either edge of the input signal passes through the trigger level.

**Timeout Value:**

Timeout value represents the maximum time that the signal remains idle before the signal passes through the trigger level. Press **Timeout**, and then rotate the multifunction knob  or use the pop-up numeric keypad to set the timeout value of Timeout trigger. The available range is from 16 ns to 10 s.

**Trigger Mode:**

In the trigger control area (Trigger) on the front panel, press **Mode** to quickly switch the current trigger mode. For details, refer to descriptions in "**Trigger Mode**".

**Trigger Parameter Setting:**

Set the trigger parameter (noise rejection) under this trigger type. For details, refer to descriptions in "**Noise Rejection**".

**Trigger LEVEL/Threshold Level:**

Rotate the **Trigger**  **LEVEL** knob to adjust the trigger level/threshold level. Refer to "**Trigger LEVEL/Threshold Level**". The current trigger level/threshold level value is displayed at the upper-right corner of the screen.

## Runt Trigger

This trigger mode is used to trigger pulses that pass through one trigger level but fail to pass through another trigger level, as shown in the figure below.

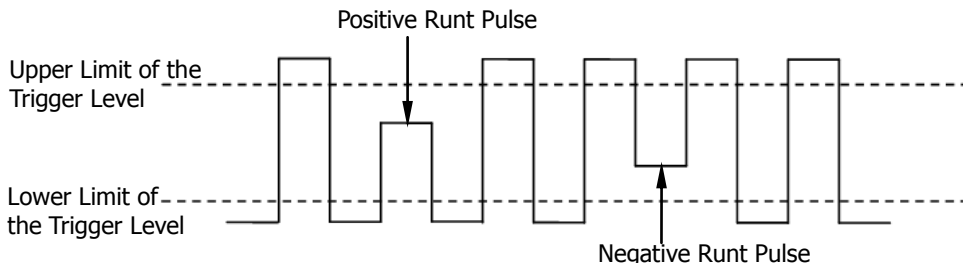



Figure 5-9 Runt Trigger

### Trigger Type:

Press **Type**, and then rotate the multifunction knob  to select "Runt". Press down the knob to select the trigger type. Then, the current trigger setting information is displayed at the upper-right corner of the screen, as shown in the figure below. You can also press **Type** continuously to select the trigger type or enable the touch screen to tap the desired trigger type and select it.

T Runt  Δ 10.0 V



### Source Selection:

Press **Source** to switch the trigger source and select CH1-CH4. For details, refer to descriptions in "**Trigger Source**". The current trigger source is displayed at the upper-right corner of the screen.

**Note:** Only when we select the channel (that has been input with signals) as the trigger source, can we obtain a stable trigger.

### Polarity:

Press **Polarity** continuously to select the pulse polarity of Runt trigger.

-  Positive: triggers on the positive runt pulse.
-  Negative: triggers on the negative runt pulse.

### Trigger Condition:

Press **When** and rotate the multifunction knob  to set the trigger conditions of Runt trigger. You can also press **When** continuously or enable the touch screen to select it.

- **None:** indicates not setting the trigger condition of Runt trigger.
- **>:** triggers when the runt pulse width is greater than the lower limit of pulse width. Press **Lower** to set the minimum pulse width of Runt trigger.
- **<:** triggers when the runt pulse width is smaller than the upper limit of pulse width. Press **Upper** to set the maximum pulse width of Runt trigger.



- **<>**: triggers when the runt pulse width is greater than the lower limit and smaller than the upper limit of pulse width. Press **Upper** to set the maximum pulse width of Runt trigger. Press **Lower** to set the minimum pulse width of Runt trigger.

**Note:** The lower limit of the pulse width must be smaller than the upper limit.

### Level Selection and Adjustment of Trigger Level:

After the trigger condition setting is completed, you need to adjust the trigger level to correctly trigger the signal and obtain a stable waveform. Press **Level Select** (when "**<>**" is selected as the trigger condition, **Level Select** is a sub-menu under **More**), then rotate the multifunction knob  to select the desired level type for adjustment, and then press down the knob to select the type. You can also press **Level Select** continuously to select the level type or enable the touch screen to tap the desired level type and select it.

Level A: only adjusts the upper limit of the trigger level, and the lower limit of the trigger level remains unchanged.

Level B: only adjusts the lower limit of the trigger level, and the upper limit of the trigger level remains unchanged.

Level AB: adjusts the upper and lower limits of the trigger level at the same time, and the trigger level deviation (the difference between the upper limit and lower limit of the trigger level) remains unchanged.

**Note:** In Runt trigger, pressing **Trigger**  **LEVEL** can quickly switch the current level adjustment type.

Rotate the **Trigger**  **LEVEL** knob to adjust the corresponding trigger level.

During the adjustment of trigger level, two trigger level lines appear on the screen, and they move up and down with the change of the trigger level. At the same time, the real-time trigger level information is displayed at the lower-left corner of the screen (as shown in the figure below, H indicates the upper limit of the trigger level, L indicates the lower limit of the trigger level, and  $\Delta$  indicates the trigger level deviation). When you stop modifying the trigger level, the trigger level line and the trigger level information at the lower-left corner of the screen disappear in about 2 s. The current trigger level deviation is displayed at the upper-right corner of the screen.

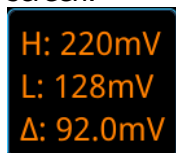

H: 220mV  
L: 128mV  
 $\Delta$ : 92.0mV

### Trigger Mode:

In the trigger control area (Trigger) on the front panel, press **Mode** to quickly switch the current trigger mode. For details, refer to descriptions in "**Trigger Mode**".

### Trigger Parameter Setting:

Set the trigger parameters (trigger holdoff and noise rejection) under this trigger

type. For details, refer to descriptions in "**Trigger Holdoff**" and "**Noise Rejection**".

## Window Trigger

Window trigger provides a high trigger level and a low trigger level. The instrument triggers when the input signal passes through the high trigger level or the low trigger level.

### Trigger Type:

Press **Type**, and then rotate the multifunction knob  to select "Window". Press down the knob to select the trigger type. Then, the current trigger setting information is displayed at the upper-right corner of the screen, as shown in the figure below. You can also press **Type** continuously to select the trigger type or enable the touch screen to tap the desired trigger type and select it.







### Source Selection:

Press **Source** to switch the trigger source and select CH1-CH4. For details, refer to descriptions in "**Trigger Source**". The current trigger source is displayed at the upper-right corner of the screen.

**Note:** Only when we select the channel (that has been input with signals) as the trigger source, can we obtain a stable trigger.

### Edge Type:

Press **Slope**, and then rotate the multifunction knob  to select the input signal the edge on which the oscilloscope triggers. You can also press the **Slope** key continuously or enable the touch screen to select the desired edge type.

-  Rising: triggers on the rising edge of the input signal when the voltage level is higher than the preset high trigger level.
-  Falling: triggers on the falling edge of the input signal when the voltage level is lower than the preset low trigger level.
-  Either: triggers on the rising or falling edge of the input signal when the voltage level meets the preset trigger level.

### Trigger Position:

After selecting the window type, press **Position** and then rotate the multifunction knob  to select the trigger position so as to further specify the time point of trigger. Press down the knob to select the trigger position. You can also press **Position** continuously or enable the touch screen to select it.

- **Enter:** triggers when the input signal enters the specified trigger level range.
- **Exit:** triggers when the input signal exits the specified trigger level range.
- **Time:** triggers when the accumulated hold time since the input signal entered

the specified trigger level range is equal to the window time. When this type is selected, press **Time** and rotate the multifunction knob  to set the window time. You can also use the numeric keypad to set it. Its available range is from 8 ns to 10 s.

### Level Selection and Adjustment of Trigger Level:

After the trigger condition setting is completed, you need to adjust the trigger level to correctly trigger the signal and obtain a stable waveform. Press **Level Select**, then rotate the multifunction knob  to select the desired level type for adjustment, and then press down the knob to select the type. You can also press **Level Select** continuously to select the level type or enable the touch screen to tap the desired level type and select it.

- Level A: only adjusts the upper limit of the trigger level, and the lower limit of the trigger level remains unchanged.
- Level B: only adjusts the lower limit of the trigger level, and the upper limit of the trigger level remains unchanged.
- Level AB: adjusts the upper and lower limits of the trigger level at the same time, and the trigger level deviation (the difference between the upper limit and lower limit of the trigger level) remains unchanged.

**Note:** In Window trigger, pressing **Trigger**  **LEVEL** can quickly switch the current level adjustment type.

Rotate the **Trigger**  **LEVEL** knob to adjust the corresponding trigger level.

During the adjustment of trigger level, two trigger level lines appear on the screen, and they move up and down with the change of the trigger level. At the same time, the real-time trigger level and slope information is displayed at the lower-left corner of the screen (as shown in the figure below, H indicates the upper limit of the trigger level, L indicates the lower limit of the trigger level, and  $\Delta$  indicates the trigger level deviation). When you stop modifying the trigger level, the trigger level line and the trigger level information at the lower-left corner of the screen disappear in about 2 s. The current trigger level deviation is displayed at the upper-right corner of the screen.

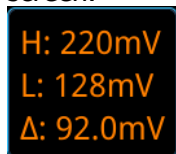

H: 220mV  
L: 128mV  
 $\Delta$ : 92.0mV

### Trigger Mode:

In the trigger control area (Trigger) on the front panel, press **Mode** to quickly switch the current trigger mode. For details, refer to descriptions in "**Trigger Mode**".

### Trigger Parameter Setting:

Set the trigger parameters (trigger holdoff and noise rejection) under this trigger type. For details, refer to descriptions in "**Trigger Holdoff**" and "**Noise Rejection**".

## Delay Trigger

In Delay trigger, you need to set Source A and Source B. The oscilloscope triggers when the time difference ( $\Delta T$ ) between the specified edges of Source A (Edge A) and Source B (Edge B) meets the preset time limit, as shown in the figure below.

**Note:** Edge A and Edge B must be two neighboring edges.

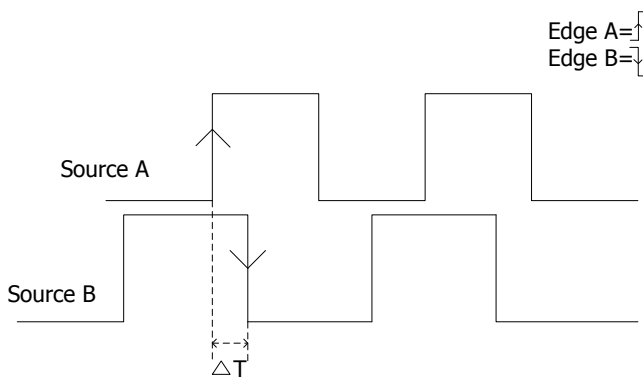



Figure 5-10 Delay Trigger

### Trigger Type:

Press **Type**, and then use the multifunction knob  to select "Delay". Press down the knob to select the trigger type. Then, the current trigger setting information is displayed at the upper-right corner of the screen, as shown in the figure below. You can also press **Type** continuously to select the trigger type or enable the touch screen to tap the desired trigger type and select it.





### Source A:

Press **SourceA** to select CH1-CH4 or D0-D15 as the trigger source of Source A. For details, please refer to descriptions in "**Trigger Source**". The current trigger source is displayed at the upper-right corner of the screen.

**Note:** Only when we select the channel (that has been input with signals) as the trigger source, can we obtain a stable trigger.

### Edge A:

Press **EdgeA** continuously to select the trigger edge type of Source A in Delay trigger. It can be set to "Rising"  or "Falling" .

### Source B:

Press **SourceB** to select CH1-CH4 or D0-D15 as the trigger source of Source B. For details, refer to descriptions in "**Trigger Source**". The current trigger source is displayed at the upper-right corner of the screen.

**Note:** Only when we select the channel (that has been input with signals) as the trigger source, can we obtain a stable trigger.

**Edge B:**

Press **EdgeB** continuously to select the trigger edge type of Source B in Delay trigger. It can be set to "Rising"  or "Falling" .

**Trigger Condition:**

Press **When** to set the time limit condition of Delay trigger.

- **>**: triggers when the time difference ( $\Delta T$ ) between the specified edges of Source A and Source B is greater than the preset time lower limit. Press **Lower** to set the delay time lower limit in Delay trigger.
- **<**: triggers when the time difference ( $\Delta T$ ) between the specified edges of Source A and Source B is smaller than the preset time upper limit. Press **Upper** to set the delay time upper limit in Delay trigger.
- **<>**: triggers when the time difference ( $\Delta T$ ) between the specified edges of Source A and Source B is greater than the lower limit of the preset time and smaller than the upper limit of the preset time. Press **Upper** to set the delay time upper limit in Delay trigger. Press **Lower** to set the delay time lower limit in Delay trigger.  
**Note:** The lower time limit must be smaller than the upper time limit.
- **><**: triggers when the time difference ( $\Delta T$ ) between the specified edges of Source A and Source B is smaller than the lower limit of the preset time or greater than the upper limit of the preset time. Press **Upper** to set the delay time upper limit in Delay trigger. Press **Lower** to set the delay time lower limit in Delay trigger.  
**Note:** The lower time limit must be smaller than the upper time limit.

**Trigger Mode:**

In the trigger control area (Trigger) on the front panel, press **Mode** to quickly switch the current trigger mode. For details, refer to descriptions in "**Trigger Mode**".

**Trigger Parameter Setting:**

Set the trigger parameters (trigger holdoff and noise rejection) under this trigger type. For details, refer to descriptions in "**Trigger Holdoff**" and "**Noise Rejection**".

**Trigger LEVEL/Threshold Level:**

Rotate the **Trigger**  **LEVEL** knob to adjust the trigger level/threshold level. Refer to "**Trigger LEVEL/Threshold Level**". The current trigger level/threshold level value is displayed at the upper-right corner of the screen.

## Setup/Hold Trigger

In Setup/Hold trigger, you need to set the clock source and data source. The setup time starts when the data signal passes the trigger level and ends at the coming of the specified clock edge; the hold time starts at the coming of the specified clock edge and ends when the data signal crosses the trigger level again, as shown in the figure below. The oscilloscope triggers when the setup time or hold time is smaller than the preset time.

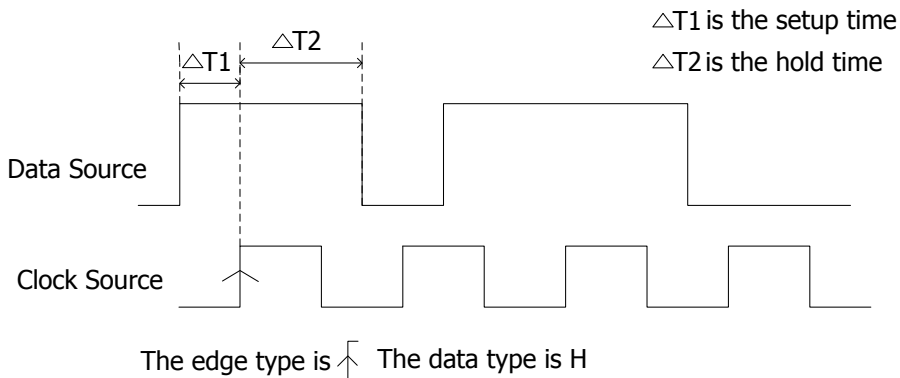

Figure 5-11 Setup/Hold Trigger

### Trigger Type:

Press **Type**, and then rotate the multifunction knob to select "Setup/Hold". Press down the knob to select the trigger type. Then, the current trigger setting information is displayed at the upper-right corner of the screen, as shown in the figure below. You can also press **Type** continuously to select the trigger type or enable the touch screen to tap the desired trigger type and select it.



### Clock Source:

Press **SCL** to set the signal source of the clock line. It can be set to CH1-CH4 or D0-D15. For details, refer to descriptions in "**Trigger Source**". The current clock source (trigger source) is displayed at the upper-right corner of the screen.

**Note:** Only when we select the channel (that has been input with signals) as the clock source, can we obtain a stable trigger.

### Edge Type:

Press **Slope** continuously to select the desired clock edge type, and it can be set to "Rising" or "Falling" .

### Data Source:

Press **SDA** to set the signal source of the data line. It can be set to CH1-CH4 or D0-D15. For details, refer to descriptions in "**Trigger Source**". The current data

source (trigger source) is displayed at the upper-right corner of the screen.



**Note:** Only when we select the channel (that has been input with signals) as the trigger source, can we obtain a stable trigger.

#### Data Type:

Press **Data Type** continuously to set the effective pattern of the data signal. It can be set to H (high level) or L (low level).

#### Trigger Condition:

Press **When** and rotate the multifunction knob  to select the trigger condition of Setup/Hold trigger. Press down the knob to select the trigger condition. You can also press **When** continuously or enable the touch screen to select it.

- **Setup:** the oscilloscope triggers when the setup time is smaller than the specified setup time. After selecting this type, press **Setup** and rotate the multifunction knob  to set the setup time. You can also use the pop-up numeric keypad to set it.
- **Hold:** the oscilloscope triggers when the hold time is smaller than the specified hold time. After selecting this type, press **Hold** and rotate the multifunction knob  to set the hold time. You can also use the pop-up numeric keypad to set it.
- **Setup/Hold:** the oscilloscope triggers when the setup time or the hold time is smaller than the specified time value. After selecting this type, press **Setup** and **Hold** and rotate the multifunction knob  to set the setup time and hold time respectively. You can also use the pop-up numeric keypad to set them.

#### Trigger Mode:

In the trigger control area (Trigger) on the front panel, press **Mode** to quickly switch the current trigger mode. For details, refer to descriptions in "**Trigger Mode**".

#### Trigger Parameter Setting:

Set the trigger parameter (noise rejection) under this trigger type. For details, refer to descriptions in "**Noise Rejection**".

#### Trigger LEVEL/Threshold Level:

Rotate the **Trigger**  **LEVEL** knob to adjust the trigger level/threshold level. Refer to "**Trigger LEVEL/Threshold Level**". The current trigger level/threshold level value is displayed at the upper-right corner of the screen.

## Nth Edge Trigger

Triggers on the Nth edge that appears after the specified idle time. For example, in the waveform shown in the figure below, the instrument should trigger on the second rising edge after the specified idle time (the time between two neighboring rising edges), and the idle time should be within the range between P and M ( $P < \text{Idle Time} < M$ ). Wherein, M is the time between the first rising edge and its previous rising edge; P is the maximum time between the rising edges that participate in counting.

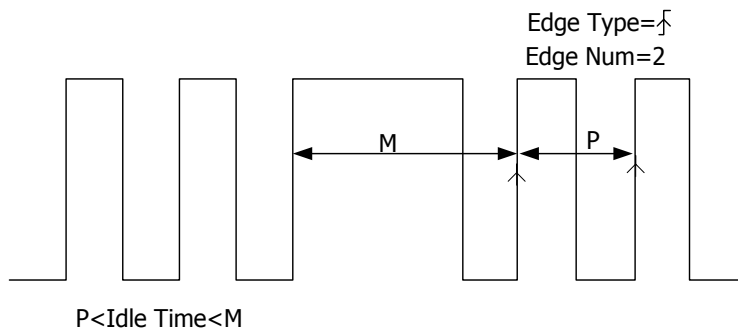

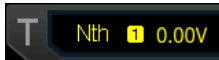

Figure 5-12 Nth Edge Trigger

### Trigger Type:

Press **Type**, and then rotate the multifunction knob  to select "Nth Edge". Press down the knob to select the trigger type. Then, the current trigger setting information is displayed at the upper-right corner of the screen, as shown in the figure below. You can also press **Type** continuously to select the trigger type or enable the touch screen to tap the desired trigger type and select it.





### Source Selection:

Press **Source** to open the signal source list and select CH1-CH4 or D0-D15. For details, refer to descriptions in "**Trigger Source**". The current trigger source is displayed at the upper-right corner of the screen.

**Note:** Only when we select the channel (that has been input with signals) as the trigger source, can we obtain a stable trigger.

### Edge Type:

Press **Slope** continuously to select the input signal edge on which the oscilloscope triggers.

-  Rising: triggers on the rising edge of the input signal when the voltage level meets the specified trigger level.
-  Falling: triggers on the falling edge of the input signal when the voltage level meets the specified trigger level.



**Idle Time:**

Press **Idle** to set the idle time before the edge counting in Nth edge trigger. Rotate the multifunction knob  or use the pop-up numeric keypad to set the idle time.

**Edge Count:**

Press **Edges** to set the value of "N" in Nth edge trigger. Rotate the multifunction knob  or use the pop-up numeric keypad to set the edge count. Its available range is from 1 to 65535.

**Trigger Mode:**

In the trigger control area (Trigger) on the front panel, press **Mode** to quickly switch the current trigger mode. For details, refer to descriptions in "**Trigger Mode**".

**Trigger Parameter Setting:**

Set the trigger parameter (noise rejection) under this trigger type. For details, refer to descriptions in "**Noise Rejection**".

**Trigger LEVEL/Threshold Level:**

Rotate the **Trigger**  **LEVEL** knob to adjust the trigger level/threshold level. Refer to "**Trigger LEVEL/Threshold Level**". The current trigger level/threshold level value is displayed at the upper-right corner of the screen.

## RS232 Trigger (Option)

RS232 bus is a serial communication mode used in data transmission between PCs or between a PC and a terminal. In RS232 serial protocol, a character is transmitted as a frame of data. The frame consists of 1 start bit, 5-8 data bits, 1 check bit, and 1-2 stop bits. Its format is as shown in the figure below. MSO5000 series oscilloscope triggers when the start frame, error frame, check error, or the specified data of the RS232 signal is detected.



Figure 5-13 Schematic Diagram of RS232 Protocol

**Trigger Type:**

Press **Type**, and then rotate the multifunction knob  to select "RS232". Press down the knob to select the trigger type. Then, the current trigger setting information is displayed at the upper-right corner of the screen, as shown in the figure below. You can also press **Type** continuously to select the trigger type or enable the touch screen to tap the desired trigger type and select it.

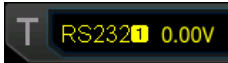
**Source:**

Press **Source** to open the signal source list and select CH1-CH4 or D0-D15. For details, refer to descriptions in "**Trigger Source**". The current trigger source is displayed at the upper-right corner of the screen.

**Note:** Only when we select the channel (that has been input with signals) as the trigger source, can we obtain a stable trigger.

**Trigger Condition:**

Press **When** to select the desired trigger condition. Rotate the multifunction knob  to select the desired trigger condition, then press down the knob to select it. You can also press **When** continuously or enable the touch screen to select it.

- Start: triggers on the start frame position.
- Error: triggers when an error frame is detected.
- Check Error: triggers when a check error is detected.
- Data: triggers on the last bit of the preset data bits. Press **Data**, then rotate the multifunction knob  or use the numeric keypad to set the data of RS232 trigger.

**Data Bits:**

Indicate the number of bits per frame. Press **More** → **Data Bits**, then rotate the multifunction knob  to select the desired data bits. Then press down the knob to select. You can also press **Data Bits** continuously or enable the touch screen to select the data bits. The available data bits include "5 Bits", "6 Bits", "7 Bits", and "8 Bits".



**Stop Bit:**

Indicate when to stop outputting. Press **More** → **Stop Bit**, then rotate the multifunction knob  to select the desired stop bit. Then press down the knob to select it. You can also press **Stop Bit** continuously or enable the touch screen to select the stop bit. The available stop bit include "1 Bit", "1.5 Bits", and "2 Bits".

**Parity:**

Used to verify whether data are properly transmitted. Press **More** → **Parity**, then rotate the multifunction knob  to select the desired parity. Then press down the knob to select it. You can also press **Parity** continuously or enable the touch screen to select the parity. The available parity include "None", "Odd", and "Even".

**Polarity**

Press **More** → **Polarity**, then select the polarity of data transmission. It can be set to "Pos"  or "Neg" .

**Baud Rate:**

Press **More** → **Baud Rate**, then select the baud rate of data transmission (i.g.

specifies a clock frequency). Three setting methods are available for baud rate:

- Press **Baud Rate**, then set the user-defined baud rate with the displayed numeric keypad.
- Press **Baud Rate**, then select the preset baud rate from the available options. The available baud rates include 50 bps, 75 bps, 110 bps, 134 bps, 150 bps, 300 bps, and etc.
- Press **Baud Rate**, then rotate the multifunction knob  to adjust the baud rate at a small step of 1 bps.

### **Trigger Mode:**

In the trigger control area (Trigger) on the front panel, press **Mode** to quickly switch the current trigger mode. For details, refer to descriptions in "**Trigger Mode**".

### **Trigger Parameter Setting:**

Set the trigger parameter (noise rejection) under this trigger type. For details, refer to descriptions in "**Noise Rejection**".

### **Trigger LEVEL/Threshold Level:**

Rotate the **Trigger**  **LEVEL** knob to adjust the trigger level/threshold level. Refer to "**Trigger LEVEL/Threshold Level**". The current trigger level/threshold level value is displayed at the upper-right corner of the screen.

## I2C Trigger (Option)

I2C is a 2-wire serial bus used to connect the microcontroller and its peripheral device. It is a bus standard widely used in the microelectronic communication control field.

The I2C serial bus consists of SCL and SDA. Its transmission rate is determined by SCL, and its transmission data is determined by SDA, as shown in the figure below. MSO5000 triggers on the start condition, restart, stop, missing acknowledgment, specific device address, or data value. Besides, it can also trigger on the specific device address and data values at the same time.

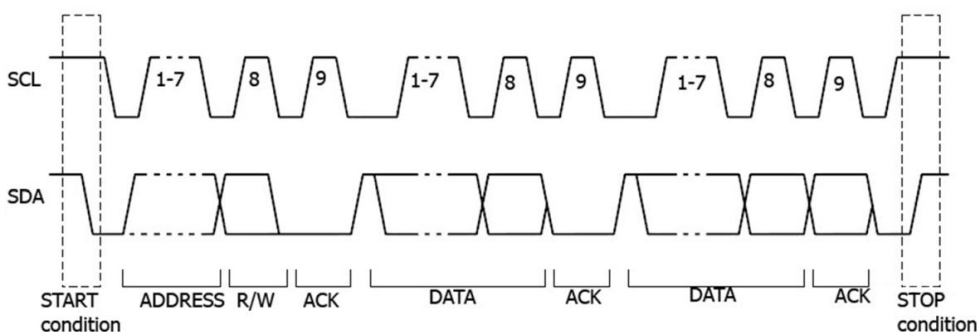



Figure 5-14 Schematic Diagram of I2C Protocol

### Trigger Type:

Press **Type**, and then rotate the multifunction knob  to select "I2C". Press down the knob to select the trigger type. Then, the current trigger setting information is displayed at the upper-right corner of the screen, as shown in the figure below. You can also press **Type** key continuously to select the trigger type or enable the touch screen to tap the desired trigger type and select it.



### Source Selection:



Press **SCL** and **SDA** to specify the signal sources of SCL and SDA respectively. They can be set to CH1-CH4 or D0-D15. For details, refer to descriptions in "**Trigger Source**". The current trigger source is displayed at the upper-right corner of the screen.

**Note:** Only when we select the channel (that has been input with signals) as the trigger source, can we obtain a stable trigger.

### Trigger Condition:

Press **When** to select the desired trigger condition. Rotate the multifunction knob  to select the desired trigger condition, then press down the knob to select it. You can also press **When** continuously or enable the touch screen to select it.

- Start: triggers when SDA data transitions from high level to low level while SCL is

- high level.
- Stop: triggers when SDA data transitions from low level to high level while SCL is high level.
- Restart: triggers when another start condition occurs before a stop condition.
- MissedAck: triggers when the SDA data is high level during any acknowledgment of SCL clock position.
- Address: the trigger searches for the specified address value. When this event occurs, the oscilloscope will trigger on the read/write bit. After this trigger condition is selected:
  - Press **AddrBits** and rotate the multifunction knob  to select the desired address bits. Then press down the knob to select it. You can also press **AddrBits** continuously or enable the touch screen to select it. The available address bits are "7 Bits", "8 Bits", and "10 Bits".
  - Press **Address**, then rotate the multifunction knob  or use the numeric keypad to set the address of I2C trigger.
  - Press **More** → **Direction** to select "Write", "Read", or "R/W".
- **Note:** This setting is not available when **AddrBits** is set to "8 Bits".
- Data: the trigger searches for the specified data value on the data line (SDA). When this event occurs, the oscilloscope will trigger on the clock line (SCL) transition edge of the last bit of data. After this trigger condition is selected:
  - Press **Bit X**, and set the current bit with the following two methods.

Method 1: First rotate the multifunction knob  to switch to the data bit that needs to be operated on. Then press down the knob continuously to set the current bit. As shown in the figure below, the left is its binary format, and the right is its corresponding Hex format.



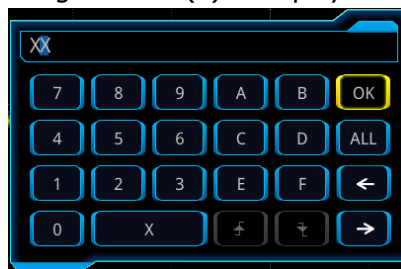
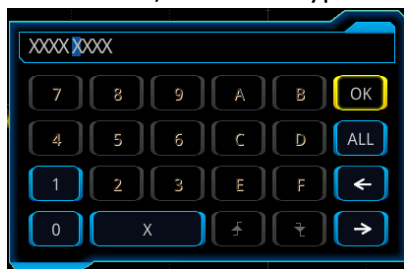

Method 2: Press **Bit X** or enable the touch screen to select the data bit. Then set it with the pop-up virtual keypad. For setting methods, refer to descriptions in "**Pattern Trigger**". If you modify the binary data bit, a virtual keypad as shown in Figure 5-15 (a) is displayed. If you modify the hex data bit, a virtual keypad as shown in Figure 5-15 (b) is displayed.



(a) Virtual Keypad for Binary Data Bit (b) Virtual Keypad for Hex Data Bit

Figure 5-15 Virtual Keypad for Data Bit Settings

- Press **Bytes**, then rotate the multifunction knob  or use the pop-up numeric keypad to set the length of the data. Its range is from 1 to 5.
- Press **More** → **Addr Bits**, and rotate the multifunction knob  to select the desired address bits. Then press down the knob to select it. You can also press **Addr Bits** continuously or enable the touch screen to select it. The available address bits are "7 Bits", "8 Bits", and "10 Bits".
- A & D: the oscilloscope searches for the specified address and data at the same time, then triggers when both the address and data meet the conditions. After this trigger condition is selected, you need to set **Bit X**, **Bytes**, **Addr Bits**, **Address**, and **Direction** menu items. For setting methods, refer to descriptions in "Address" and "Data" trigger conditions.

**Trigger Mode:**

In the trigger control area (Trigger) on the front panel, press **Mode** to quickly switch the current trigger mode. For details, refer to descriptions in "**Trigger Mode**".

**Trigger Parameter Setting:**

Set the trigger parameter (noise rejection) under this trigger type. For details, refer to descriptions in "**Noise Rejection**".

**Trigger LEVEL/Threshold Level:**

Rotate the **Trigger**  **LEVEL** knob to adjust the trigger level/threshold level. Refer to "**Trigger LEVEL/Threshold Level**". The current trigger level/threshold level value is displayed at the upper-right corner of the screen.

**SPI Trigger (Option)**

In SPI trigger, after the CS or timeout condition is satisfied, the oscilloscope triggers when the specified data is found. When using SPI trigger, you need to specify the SCL clock sources and SDA data sources. Below is the sequential chart of SPI bus.

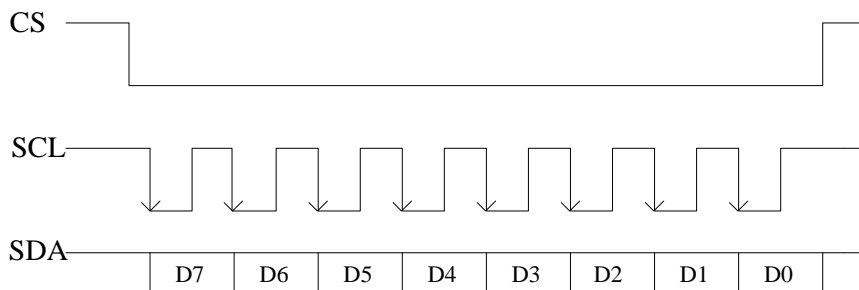



Figure 5-16 Sequential Chart of SPI Bus

**Trigger Type:**

Press **Type**, and then rotate the multifunction knob  to select "SPI". Press down the knob to select the trigger type. Then, the current trigger setting information is displayed at the upper-right corner of the screen, as shown in the figure below. You can also press **Type** continuously to select the trigger type or enable the touch screen to tap the desired trigger type and select it.



**Source Selection:**

Press **SCL** and **SDA** to specify the sources of SCL and SDA respectively. They can be set to CH1-CH4 or D0-D15. For details, refer to descriptions in "**Trigger Source**". The current trigger source is displayed at the upper-right corner of the screen.

**Note:** Only when we select the channel (that has been input with signals) as the trigger source, can we obtain a stable trigger.



**Edge Type:**

Press **Slope** continuously to select the desired clock edge type.

-  Rising: samples the SDA data on the rising edge of the clock.
-  Falling: samples the SDA data on the falling edge of the clock.

**Trigger Condition:**

Press **When** continuously to select the desired trigger condition.

- **Timeout:** the oscilloscope starts to search for the data (SDA) on which to trigger after the clock signal (SCL) stays in the idle state for a specified period of time. After selecting this condition, you can press **Timeout**, then rotate the multifunction knob  or use the pop-up numeric keypad to set the idle time. The range is from 8 ns to 10 s.
- **With CS:** if the CS signal is valid, the oscilloscope will trigger when the data (SDA) satisfying the trigger conditions is found.
  - Press **CS** to select the chip selection signal line. The available channels are CH1-CH4 or D0-D15. For details, refer to descriptions in "**Trigger Source**". The current trigger source is displayed at the upper-right corner of the screen.
  - Press **More** → **CS Mode** to set the current CS mode to "Pos" (high level is valid) or "Neg" (low level is valid).

**Current Bit:**

Press **More** → **Bit X** to set the data bit that needs to be operated on. For setting methods, refer to descriptions in "**I2C Trigger (Option)**".

**Data Bits:**

Press **More** → **DataBits**, then rotate the multifunction knob  or use the pop-up numeric keypad to set the number of bits in the serial data string. The number of bits in the string can be set to any integer ranging from 4 and 32.

**Trigger Mode:**

In the trigger control area (Trigger) on the front panel, press **Mode** to quickly switch the current trigger mode. For details, refer to descriptions in "**Trigger Mode**".

**Trigger Parameter Setting:**

Set the trigger parameter (noise rejection) under this trigger type. For details, refer to descriptions in "**Noise Rejection**".

**Trigger LEVEL/Threshold Level:**

Rotate the **Trigger**  **LEVEL** knob to adjust the trigger level/threshold level. Refer to "**Trigger LEVEL/Threshold Level**". The current trigger level/threshold level value is displayed at the upper-right corner of the screen.

## CAN Trigger (Option)

MSO5000 can trigger on the start of a frame, end of a frame, frame of the specified type (e.g. Remote, Overload, Data, etc.), or error frame of the specified type (e.g. Answer Error, Check Error, Format Error, etc.) of the CAN signal.

The data frame format of the CAN bus is as shown in the figure below.

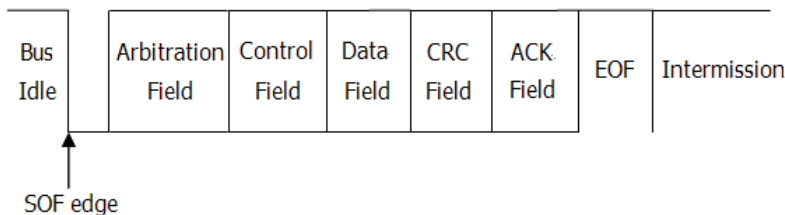



Figure 5-17 Data Frame Format of the CAN Bus

**Trigger Type:**

Press **Type**, and then rotate the multifunction knob  to select "CAN". Press down the knob to select the trigger type. Then, the current trigger setting information is displayed at the upper-right corner of the screen, as shown in the figure below. You can also press **Type** continuously to select the trigger type or enable the touch screen to tap the desired trigger type and select it.



**Source Selection:**

Press **Source** to open the signal source list and select CH1-CH4 or D0-D15. For details, refer to descriptions in "**Trigger Source**". The current trigger source is displayed at the upper-right corner of the screen.

**Note:** Only when we select the channel (that has been input with signals) as the trigger source, can we obtain a stable trigger.



**Trigger Condition:**

Press **When** to select the desired trigger condition.

- SOF: triggers at the start of a frame.
- EOF: triggers at the end of a frame.
- Remote ID: triggers on the remote frame with the specified ID. Set the following parameters:
  - Press **Extended ID** to enable or disable the extended ID.
  - Press **Bit X** to set the data bit that needs to be operated on. For setting methods, refer to descriptions in "**I2C Trigger (Option)**".
- Overload: triggers on the CAN overload frames.
- Frame ID: triggers on the data frames with the specified ID. Set the following parameters:
  - Press **Extended ID** to enable or disable the extended ID.
  - Press **Bit X** to set the data bit that needs to be operated on. For setting methods, refer to descriptions in "**I2C Trigger (Option)**".
- Frame Data: triggers on the data frames with specified data. Set the following parameters:
  - Press **Bit X** to set the data bit that needs to be operated on. For setting methods, refer to descriptions in "**I2C Trigger (Option)**".
  - Press **Bytes**, then rotate the multifunction knob  or use the numeric keypad to set the length of the data. Its range is from 1 to 8.
- Data&ID: triggers on the data frames with the specified ID and data. Set the following parameters:
  - Press **Define** to select "Data" or "ID".
  - When you select "Data", set **Bit X** and **Bytes**. For detailed settings, refer to parameter settings for "Frame Data".
  - When you select "ID", set **Extended ID** and **Bit X**. For detailed settings, refer to parameter settings for "Frame ID".
- Frame Error: triggers on the error frame.
- Bit Fill: triggers on the error frame with the bit fill.
- Answer Error: triggers on the answer error frame.
- Check Error: triggers on the check error frame.
- Format Error: triggers on the format error frame.
- Random Error: triggers on random error frame, such as the format error frame, answer error frame, etc.



**Signal Type:**

Press **More** → **Signal Type** to select the desired signal type.

- CAN\_H: indicates the actual CAN\_H bus signal.
- CAN\_L: indicates the actual CAN\_L bus signal.
- TX/RX: indicates the Transmit signal and Receive signal from the CAN bus transceiver.
- DIFF: The CAN differential bus signals connected to an analog source channel by using a differential probe. Connect the probe's positive lead to the CAN\_H bus signal and connect the negative lead to the CAN\_L bus signal.

**Baud Rate:**

Press **More** → **Baud** to set the baud rate. Three setting methods are available for baud rate:

- Press **Baud**, then set the user-defined baud rate with the displayed numeric keypad.
- Press **Baud**, then rotate the multifunction knob  to select the preset baud rate from the available options. The available baud rates include 10 kb/s, 20 kb/s, 33.3 kb/s, 50 kb/s, 62.5 kb/s, 83.3 kb/s, and etc.
- Press **Baud**, then rotate the multifunction knob  to adjust the baud rate at a small step of 0.1 kb/s.

**Sample Position:**

Sample position is a point within a bit's time. The oscilloscope samples the bit level at this point. The sample position is represented by the proportion of "the time from the start of the bit to the sample position" to the "bit time", as shown in the figure below.

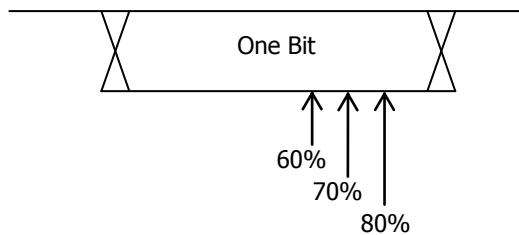



Figure 5-18 Sample Position

Press **More** → **Sample Position**, then rotate the multifunction knob  or use the pop-up numeric keypad to set the sample position. The settable range is from 10% to 90%.

**Trigger Mode:**

In the trigger control area (Trigger) on the front panel, press **Mode** to quickly switch the current trigger mode. For details, refer to descriptions in "**Trigger Mode**".

**Trigger Parameter Setting:**

Set the trigger parameter (noise rejection) under this trigger type. For details, refer to descriptions in "**Noise Rejection**".

**Trigger LEVEL/Threshold Level:**

Rotate the **Trigger**  **LEVEL** knob to adjust the trigger level/threshold level. Refer to "**Trigger LEVEL/Threshold Level**". The current trigger level/threshold level value is displayed at the upper-right corner of the screen.

## FlexRay Trigger (Option)

MSO5000 can trigger on the specified frame, symbol, error, or position of the FlexRay bus.

FlexRay is a type of differential serial bus configured with three consecutive segments (i.g. header, payload, and trailer). Its data transmission rate is up to 10 Mb/s. Each frame contains a static segment and a dynamic segment, and ends with the bus idle time.

Its format is as shown in the figure below.

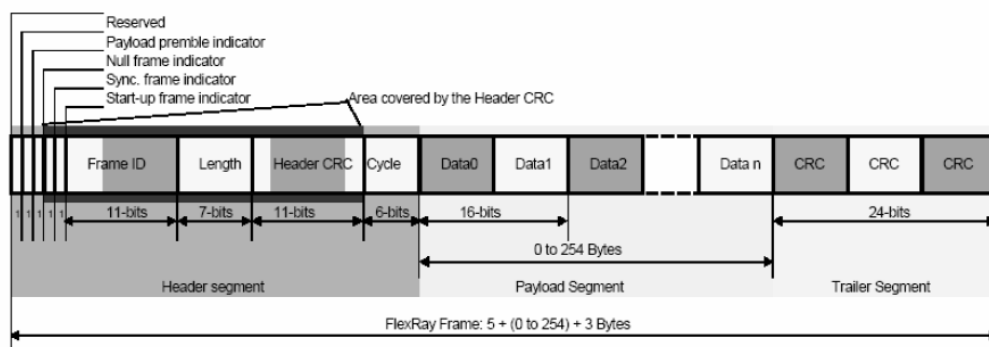



Figure 5-19 Frame Format of FlexRay Bus

### Trigger Type:

Press **Type**, and then rotate the multifunction knob  to select "FlexRay". Press down the knob to select the trigger type. Then, the current trigger setting information is displayed at the upper-right corner of the screen, as shown in the figure below. You can also press **Type** continuously to select the trigger type or enable the touch screen to tap the desired trigger type and select it.



### Source Selection:

Press **Source** to open the signal source list and select CH1-CH4 or D0-D15. For details, refer to descriptions in "**Trigger Source**". The current trigger source is displayed at the upper-right corner of the screen.

**Note:** Only when we select the channel (that has been input with signals) as the trigger source, can we obtain a stable trigger.

### Channel Selection:

The channel that matches the actual FlexRay bus signal is, by default, Channel A. The **Channel** menu is grayed out, and you are not allowed to set it manually.



### Baud Rate:

Press **Baud**, and rotate the multifunction knob  to select a FlexRay baud rate that

matches the FlexRay bus signal. Then press down the knob to select the baud rate. You can also press **Baud** continuously or enable the touch screen to select it. The available baud rates are 2.5 Mbps, 5 Mbps, and 10 Mbps.

### Trigger Condition:

Press **When**, and rotate the multifunction knob  to select the desired trigger condition, then press down the knob to select it. You can also press **When** continuously or enable the touch screen to select it.

- Post: triggers on the specified position of the FlexRay bus. Press **Post** to select "TSS End", "FSS\_BSS End", "FES End", or "DTS End".
- Frame: triggers on the frame of FlexRay bus.
  - Press **Frame** to select the frame type. The types of frames include null, Sync, Start, and All.
  - Press **More** → **Define** to select "ID" or "Cyc Count".  
When you select "ID", set the following parameters: ID Comp, ID Min, and ID Max. Press **More** → **ID Comp** to select the comparison conditions. The available choices include =, ≠, >, <, ><, <>. Press **More** → **ID Max** or press **More** → **ID Min**, then rotate the multifunction knob  or use the pop-up numeric keypad to set the frame ID.  
When you select "Cyc Count", set the following parameters: Cyc Comp, Count Min, and Count Max. Press **More** → **Cyc Comp** to select the comparison conditions. The available choices include =, ≠, >, <, ><, <>. Press **More** → **Count Max** or press **More** → **Count Min**, then rotate the multifunction knob  or use the pop-up numeric keypad to set the cycle count.
- Symbol: triggers on the CAS/MTS (Collision Avoidance Symbol/Media Access Test Symbol) and WUS (Wake Up Symbol) of FlexRay bus.
  - Press **Symbol** to select the symbol type. The symbol type includes CAS/MTS and WUS.
  - Press **More** → **ID Comp** to select the comparison conditions. The available choices include =, ≠, >, <, ><, <>. Press **More** → **ID Max** or press **More** → **ID Min**, then rotate the multifunction knob  or use the pop-up numeric keypad to set the frame ID.
- Error: triggers when an error occurs to the FlexRay bus.  
Press **Error** to select the error type. It includes Head CRC Err, Tail CRC Err, Decode Err, and Random Err.

**Note:** As the occurrence possibility of specified FlexRay frame is very low, it is recommended that you set the oscilloscope to "Normal" trigger mode when the trigger condition is set to "Frame", so as to prevent the instrument from triggering automatically while waiting for the specified frame. The same goes for "Error" trigger condition. In addition, when multiple FlexRay errors occur at the same time, you need to adjust the trigger holdoff so as to view the specific error.

**Trigger Mode:**

In the trigger control area (Trigger) on the front panel, press **Mode** to quickly switch the current trigger mode. For details, refer to descriptions in "**Trigger Mode**".

**Trigger Parameter Setting:**

Set the trigger parameter (noise rejection) under this trigger type. For details, refer to descriptions in "**Noise Rejection**".

**Trigger LEVEL/Threshold Level:**

Rotate the **Trigger**  **LEVEL** knob to adjust the trigger level/threshold level. Refer to "**Trigger LEVEL/Threshold Level**". The current trigger level/threshold level value is displayed at the upper-right corner of the screen.

**LIN Trigger (Option)**

MSO5000 can trigger on the sync field of LIN signal, and can also trigger on the specified identifier, data, or frame.

The data frame format of the LIN bus is as shown in the figure below.

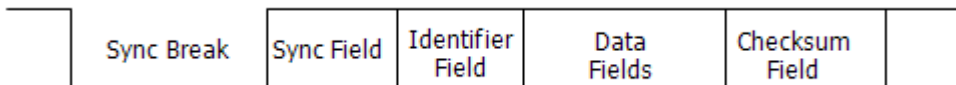

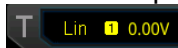

Figure 5-20 Data Frame Format of the LIN Bus

**Trigger Type:**

Press **Type**, and then rotate the multifunction knob  to select "LIN". Press down the knob to select the trigger type. Then, the current trigger setting information is displayed at the upper-right corner of the screen, as shown in the figure below. You can also press **Type** continuously to select the trigger type or enable the touch screen to tap the desired trigger type and select it.





**Source Selection:**

Press **Source** to open the signal source list and select CH1-CH4 or D0-D15. For details, refer to descriptions in "**Trigger Source**". The current trigger source is displayed at the upper-right corner of the screen.

**Note:** Only when we select the channel (that has been input with signals) as the trigger source, can we obtain a stable trigger.

**Trigger Condition:**

Press **When**, and rotate the multifunction knob  to select the desired trigger condition, then press down the knob to select it. You can also press **When** continuously or enable the touch screen to select it.



- Sync: triggers on the last bit of the sync field.
- ID: triggers when the frame with an ID equal to the selected value is detected. Press **ID**, then rotate the multifunction knob  or use the pop-up numeric keypad to set ID.
- Data: triggers when the data that meet the preset conditions are found.
  - Press **Bit X** to set the data bit that needs to be operated on. For setting methods, refer to descriptions in "**I2C Trigger (Option)**".
  - Press **Bytes**, then rotate the multifunction knob  or use the pop-up numeric keypad to set the length of the data. Its range is from 1 to 8.
- Data&ID: triggers when a frame with a specified ID and data that meet the preset conditions are both found.
  - Press **Bit X** to set the data bit that needs to be operated on. For setting methods, refer to descriptions in "**I2C Trigger (Option)**".
  - Press **Bytes**, then rotate the multifunction knob  or use the pop-up numeric keypad to set the length of the data. Its range is from 1 to 8.
  - Press **ID**, then rotate the multifunction knob  or use the pop-up numeric keypad to set ID.
- Sleep: triggers when the sleep frame is found.
- Wakeup: triggers when the wakeup frame is found.
- Error: triggers on the specified type of error frame. Press **Error Type** and select the desired error type: Sync, Even Odd, or Check Sum.

### Protocol Version:

Press **More** → **Version** to select the protocol version that matches the signal under test. The available versions include 1.X and 2.X.

### Baud Rate:

Press **More** → **Baud** to set the baud rate. Three setting methods are available for baud rate:

- Press **Baud**, then set the user-defined baud rate with the displayed numeric keypad.
- Press **Baud**, then rotate the multifunction knob  to select the preset baud rate from the available options. The available baud rates include 1.2 kbps, 2.4 kbps, 4.8 kbps, 9.6 kbps, 19.2 kbps, and etc.
- Press **Baud**, then rotate the multifunction knob  to adjust the baud rate at a small step.

### Sample Position:

Sample position is a point within a bit's time. The oscilloscope samples the bit level at this point. The sample position is represented by the proportion of "the time from the start of the bit to the sample position" to the "bit time", as shown in the figure below.

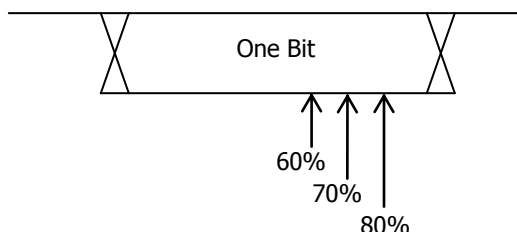



Figure 5-21 Sample Position

Press **More** → **Sample Position**, then rotate the multifunction knob  or use the pop-up numeric keypad to set the sample position. The settable range is from 10% to 90%.

### Trigger Mode:

In the trigger control area (Trigger) on the front panel, press **Mode** to quickly switch the current trigger mode. For details, refer to descriptions in "**Trigger Mode**".

### Trigger Parameter Setting:

Set the trigger parameter (noise rejection) under this trigger type. For details, refer to descriptions in "**Noise Rejection**".

### Trigger LEVEL/Threshold Level:

Rotate the **Trigger**  **LEVEL** knob to adjust the trigger level/threshold level. Refer to "**Trigger LEVEL/Threshold Level**". The current trigger level/threshold level value is displayed at the upper-right corner of the screen.

## I2S Trigger (Option)

In I2S trigger, the oscilloscope searches for the specified data value and take it as the condition for identifying the trigger. You need to specify the serial clock line (SCLK, 1 pulse is found on the clock line once 1 bit of digital audio data is sent), frame clock line (WS, used for switch the audio channel data), and serial data line (SDA, used for transmit audio data represented in binary (2's complement)). This trigger type is only available for the MSO5XX4 model and the model installed with the MSO5000-4CH option.

Below is the sequential chart of I2S bus.

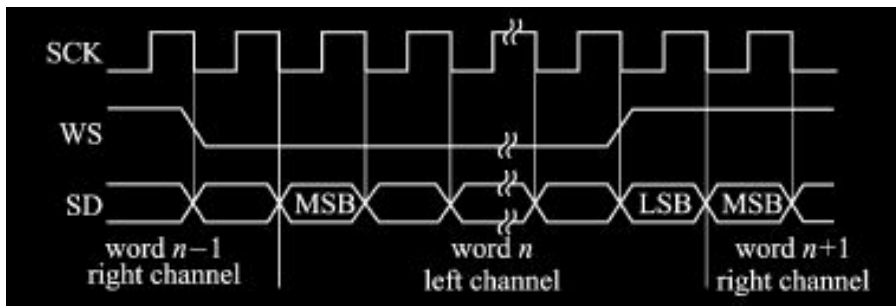



Figure 5-22 Sequential Chart of I2S Bus

**Trigger Type:**

Press **Type**, and then rotate the multifunction knob  to select "I2S". Press down the knob to select the trigger type. Then, the current trigger setting information is displayed at the upper-right corner of the screen, as shown in the figure below. You can also press **Type** continuously or enable the touch screen to tap the desired trigger type and select it.



**Source Selection:**

Press **SCLK**, **WS**, and **SDA** to specify the sources for SCLK, WS, and SDA respectively. The available choices are CH1-CH4 or D0-D15. For details, refer to descriptions in "**Trigger Source**". The current trigger source is displayed at the upper-right corner of the screen.

**Note:** Only when we select the channel (that has been input with signals) as the trigger source, can we obtain a stable trigger.

**Edge Type:**

Press **SCLK Edge** continuously or rotate the multifunction knob  to select the desired clock edge.

-  Rising: samples the SDA data on the rising edge of the clock.
-  Falling: samples the SDA data on the falling edge of the clock.

**Audio:**

Press **Audio** continuously or rotate the multifunction knob  to select "Left", "Right", or "Either".

**Trigger Condition:**

Press **When**, and rotate the multifunction knob  to select the desired trigger condition, then press down the knob to select it. You can also press **When** continuously or enable the touch screen to select it.

- **=:** triggers when the channel's data equal the set data value. Press **Data** to set the data bit. For setting methods, refer to descriptions in "**I2C Trigger (Option)**".



- $\neq$ : triggers when the channel's data do not equal the set data value. Press **Data** to set the data bit. For setting methods, refer to descriptions in "**I2C Trigger (Option)**".
- $>$ : triggers when the channel's data are greater than the set data value. Press **Data Min** to set the lower limit of the data bit. For setting methods, refer to descriptions in "**I2C Trigger (Option)**".
- $<$ : triggers when the channel's data are smaller than the set data value. Press **Data Max** to set the upper limit of the data bit. For setting methods, refer to descriptions in "**I2C Trigger (Option)**".
- $><$ : triggers when the channel's data are smaller than the upper limit of the data value and greater than the lower limit of the data value. Press **Data Max** and **Data Min** to set the upper limit and lower limit of the data bit respectively. For setting methods, refer to descriptions in "**I2C Trigger (Option)**".
- $<>$ : triggers when the channel's data are greater than the upper limit of the data value and smaller than the lower limit of the data value. Press **Data Max** and **Data Min** to set the upper limit and lower limit of the data bit respectively. For setting methods, refer to descriptions in "**I2C Trigger (Option)**".

### Width:

Press **More** → **Width**, then rotate the multifunction knob  or use the pop-up numeric keypad to set the width. Its range is from 4 to 32.

### User Width:

Press **More** → **User Width**, then rotate the multifunction knob  or use the pop-up numeric keypad to set the user width. Its range is from 4 to 32.

**Note:** The user width is smaller than or equal to the width.

### Alignment:

Press **More** → **Alignment** and rotate the multifunction knob  to select the alignment way for data signal. You can also press **Alignment** continuously to select the alignment way or enable the touch screen to tap the desired alignment way and select it.

I2S: MSB (Most Significant Bit) of data for each sample is sent first, and LSB (Least Significant Bit) is sent last. The MSB appears on the SDA line one bit clock after the edge of the WS transition.

LJ: data transmission (MSB first) begins at the edge of the WS transition.

RJ: data transmission (MSB first) is right-justified to the WS transition.

### Data:

Press **More** → **Data**, and set the data of the current bit. For setting methods, refer to descriptions of the **Bit X** key in "**I2C Trigger (Option)**".

### Trigger Mode:

In the trigger control area (Trigger) on the front panel, press **Mode** to quickly switch the current trigger mode. For details, refer to descriptions in "**Trigger Mode**".

**Trigger Parameter Setting:**

Set the trigger parameter (noise rejection) under this trigger type. For details, refer to descriptions in "**Noise Rejection**".

**Trigger LEVEL/Threshold Level:**

Rotate the **Trigger**  **LEVEL** knob to adjust the trigger level/threshold level. Refer to "**Trigger LEVEL/Threshold Level**". The current trigger level/threshold level value is displayed at the upper-right corner of the screen.

**MIL-STD-1553 Trigger (Option)**

1553B is the abbreviation for the MIL-STD-1553 bus. MSO5000 can trigger on the sync field of 1553B bus, and can also trigger on the specified data word, command word, status word, or error type.

**Trigger Type:**

Press **Type**, and then rotate the multifunction knob  to select "MIL-STD-1553". Press down the knob to select the trigger type. Then, the current trigger setting information is displayed at the upper-right corner of the screen, as shown in the figure below. You can also press **Type** continuously or enable the touch screen to tap the desired trigger type and select it.

**Source Selection:**

Press **Source** to open the signal source list and select CH1-CH4. For details, refer to descriptions in "**Trigger Source**". The current trigger source is displayed at the upper-right corner of the screen.

**Note:** Only when we select the channel (that has been input with signals) as the trigger source, can we obtain a stable trigger.

**Trigger Condition:**

Press **When**, and rotate the multifunction knob  to select the desired trigger condition, then press down the knob to select it. You can also press **When** continuously or enable the touch screen to select it.

- Sync: triggers on the specified sync type. After the trigger condition is selected, press **Sync** to select the desired sync type: Data Sync, Cmd/Status Sync, or All Sync.
- Data: triggers on the specified data word. After the trigger condition is selected, press **Comp** to select the comparison conditions. The available choices include =, ≠, >, <, ><, <>.
  - =: triggers when the channel's data word equals the set data word. Press **Min** to set the lower limit of the data word. For setting methods, refer to descriptions in "**I2C Trigger (Option)**".

- #: triggers when the channel's data word does not equal the set data word. Press **Min** to set the lower limit of the data word. For setting methods, refer to descriptions in "**I2C Trigger (Option)**".
- <: triggers when the channel's data word is smaller than the set data word. Press **Max** to set the upper limit of the data word. For setting methods, refer to descriptions in "**I2C Trigger (Option)**".
- >: triggers when the channel's data word is greater than the set data word. Press **Min** to set the lower limit of the data word. For setting methods, refer to descriptions in "**I2C Trigger (Option)**".
- ><: triggers when the channel's data word is smaller than the upper limit of the data word and greater than the lower limit of the data word. Press **Max** and **Min** to set the upper limit and lower limit of the data word respectively. For setting methods, refer to descriptions in "**I2C Trigger (Option)**".
- <>: triggers when the channel's data word is greater than the upper limit of the data word and smaller than the lower limit of the data word. Press **Max** and **Min** to set the upper limit and lower limit of the data word respectively. For setting methods, refer to descriptions in "**I2C Trigger (Option)**".
- RTA: triggers on the specified remote terminal address. After this trigger condition is selected, press **RTA** to set the remote terminal address. For setting methods, refer to descriptions in "**I2C Trigger (Option)**".
- RTA+11Bit: triggers on the RTA and the remaining 11 bits. After this trigger condition is selected:
  - Press **RTA** to set the remote terminal address. For setting methods, refer to descriptions in "**I2C Trigger (Option)**".
  - Press **Bit time** to set the bit time position value to 0 (low), 1 (high), or X (don't care). For setting methods, refer to descriptions in "**I2C Trigger (Option)**".
- Error: triggers on the specified error type. After this trigger condition is selected, press **Err Type** to select the error type.
  - Sync Error: triggers when an invalid sync pulse is found.
  - Check Error: triggers when the parity bit is incorrect for the data in the word.

### Level Selection and Adjustment of Trigger Level:

After the trigger condition setting is completed, you need to adjust the trigger level to correctly trigger the signal and obtain a stable waveform. Press **Level Select** (when "Data" is selected for the trigger condition, press **More** → **Level Select**), then rotate the multifunction knob  to select the desired level type for adjustment, and then press down the knob to select the type. You can also press **Level Select** continuously or enable the touch screen to tap the desired level type and select it.

- Level A: only adjusts the upper limit of the trigger level, and the lower limit of the trigger level remains unchanged.
- Level B: only adjusts the lower limit of the trigger level, and the upper limit of the trigger level remains unchanged.
- Level AB: adjusts the upper and lower limits of the trigger level at the same time, and the trigger level deviation (the difference between the upper limit and lower

limit of the trigger level) remains unchanged.

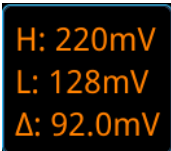

**Note:** In MIL-STD-1553 trigger, pressing **Trigger**  **LEVEL** can quickly switch the current level adjustment type.

Rotate the **Trigger**  **LEVEL** knob to adjust the corresponding trigger level. During the adjustment of trigger level, two trigger level lines appear on the screen, and they move up and down with the change of the trigger level. At the same time, the real-time trigger level and slope information is displayed at the lower-left corner of the screen (as shown in the figure below, H indicates the upper limit of the trigger level, L indicates the lower limit of the trigger level, and  $\Delta$  indicates the trigger level deviation). When you stopping modifying the trigger level, the trigger level line and the trigger level information at the lower-left corner of the screen disappear in about 2 s. The current trigger level deviation is displayed at the upper-right corner of the screen.



H: 220mV  
L: 128mV  
 $\Delta$ : 92.0mV

#### **Polarity:**

Press **More** → **Polarity** to select the desired polarity. The polarities available are positive polarity () and negative polarity ()

#### **Trigger Mode:**

In the trigger control area (Trigger) on the front panel, press **Mode** to quickly switch the current trigger mode. For details, refer to descriptions in "**Trigger Mode**".

#### **Trigger Parameter Setting:**

Set the trigger parameter (noise rejection) under this trigger type. For details, refer to descriptions in "**Noise Rejection**".

## **Zone Trigger**

MSO5000 series oscilloscope supports the zone trigger and provides two rectangle areas: Trigger zone A and Trigger zone B. You can set the trigger conditions to "Intersect" or "Not intersect". Refer to "**Rectangle Drawing**" to select "Trigger zone A" or "Trigger zone B" to open the zone trigger setting menu. You can also press **Measure** → **Analyze** → **Zone trigger** to enter the zone trigger setting menu.

#### **Enable or disable Trigger zone A or Trigger zone B:**

Press **Zone A enable** or **Zone B enable** continuously to enable or disable Trigger zone A or Trigger zone B. You can also refer to "**Rectangle Drawing**" to select "Trigger zone A" or "Trigger zone B" to enable Trigger zone A or Trigger zone B. If

both Trigger zone A and Trigger zone B are disabled, then the zone trigger function is disabled. At this time, you must enable either of them to re-enable the zone trigger.

**Note:** If the zone trigger function is enabled, "**XY Mode**", "**ROLL Mode**", and "**Average**" are disabled.

#### Select Source A or Source B:

Press **Source A** or **Source B**, then rotate the multifunction knob  to select the desired source, and then press down the knob to select the source. You can also press **Source A** or **Source B** continuously to select the trigger source or enable the touch screen to tap the desired trigger source and select it. The available sources include CH1-CH4. The zone name color and the zone color are the same as the color of the selected source channel.

#### Set the conditions for Trigger zone A and Trigger zone B:

Press **Zone A** or **Zone B**, rotate the multifunction knob  to select "Intersect" or "Not intersect", then press down the knob to select it. You can also press **Zone A** or **Zone B** continuously to select the condition, or enable the touch screen to tap the desired condition and select it.

If you enable Zone A, select CH1 as Source A, and select "Intersect" as the condition, as shown in the figure below.



If you enable Zone A, select CH1 as Source A, and select "Intersect" as the condition, the following figure is displayed.

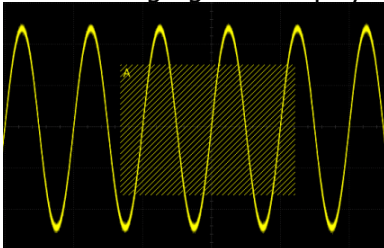

**Tip**  
If you enable both Trigger zone A and Trigger zone B, then perform the "A&&B" operation, and it will become the final trigger condition.

## Trigger Output Connector

The trigger output connector (**[TRIG OUT]**) on the rear panel of MSO5000 series can output trigger signals (hardware trigger) determined by the current setting.

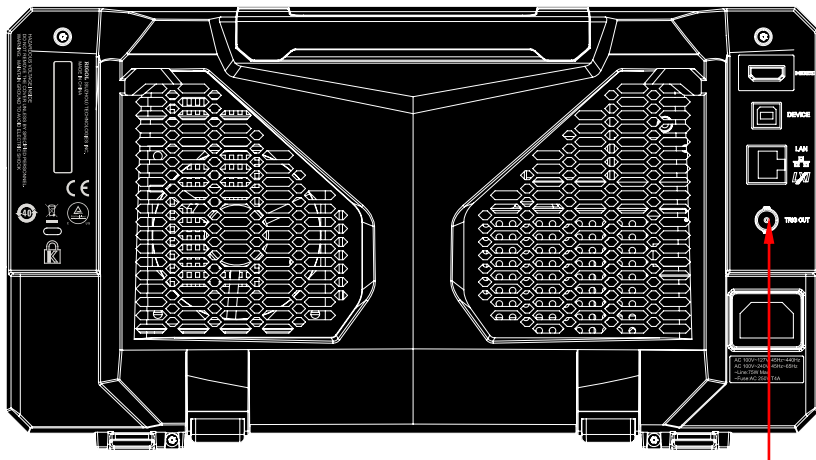

Trigger Output Connector

Figure 5-23 Trigger Output Connector

Press **Utility** → **System** → **AUX Out** to select "TrigOut". A signal which reflects the current capture rate of the oscilloscope can be output from the **[TRIG OUT]** connector each time a trigger is generated by the oscilloscope. If this signal is connected to a waveform display device to measure the frequency, the measurement result is the same as the current capture rate.

**Note:** If you press **Utility** → **System** → **AUX Out** to select "PassFail", then in the pass/fail test, when a pass/fail event is detected, the oscilloscope outputs a pulse from the rear-panel **[TRIG OUT]** connector.

## Chapter 6 Operations and Measurements

MSO5000 can perform math operations, auto measurements, and cursor measurements on sampled and displayed data.

Contents in this chapter:

- Math Operation
- Auto Measurement
- Cursor Measurement

## Math Operation

Press **Math** in the vertical control area (Vertical) on the front panel to open the math operation menu. You can also tap the function navigation icon  at the lower-left corner of the screen to open the function navigation. Then tap the "Math" icon to open the math operation menu. This oscilloscope supports four math operations: Math1, Math2, Math3, and Math4. The following section takes Math1 as an example to introduce the math operation in detail.

Press **Math** → **Math1** → **Operator** to select the desired math function. Press **Operation** continuously to enable or disable the operation. When enabled, the results of math operation are displayed with purple waveforms on the screen, and the math operation formula, vertical scale, and other parameters (the displayed data parameters are different for different math operations) are displayed at the bottom of the screen. The results of the math operation can be further measured. This oscilloscope supports enabling the four math operations at the same time, as shown in the figure below.

1	CH1+CH2	5mV	2.5GSa/s
2	CH4+CH1	500mV	2.5GSa/s
3	CH2+CH3	50mV	2.5GSa/s
4	CH1+CH3	20mV	2.5GSa/s

MSO5000 series can realize multiple math operations between waveforms of different channels, including

- arithmetic operations (A+B, A-B, A×B, and A/B)
- FFT operation
- logic operation: A&&B, A||B, A^B, and !A
- function operation: Intg, Diff, Sqrt, Lg, Ln, Exp, Abs, and AX+B (linear function)
- math filter: low-pass filter, high-pass filter, band-pass filter, and band-stop filter

**Note:** When you select the source, only the enabled channel is available.

## Addition

Adds the waveform voltage values of signal source A and B point by point and displays the results.

Press **MATH** → **Math1** → **Operator** to select "A+B":

- Press **Operation** continuously to enable or disable the addition operation function.
- Press **SourceA** and **SourceB** respectively, and rotate the multifunction knob  to select the channel for SourceA and Source B. Then press down the knob to select the channel. You can also press **SourceA** and **SourceB** continuously



or enable the touch screen to select the channel. The available channels for SourceA and SourceB are CH1-CH4 and Ref1-Ref10.

**Note:** The available channels for Math2 are CH1-CH4, Ref1-Ref10 or Math1. The available channels for Math3 are CH1-CH4, Ref1-Ref10, Math1 or Math2. The available channels for Math4 are CH1-CH4, Ref1-Ref10, Math1, Math2 or Math3. Only the channels that have been enabled currently can be selected.

- Press **Offset** to set the vertical offset of the operation results. For setting methods, refer to the descriptions in "**Parameter Setting Method**". You can also enable the touch screen and use the "Drag" gesture to adjust the vertical offset.
- Press **Scale** to set the vertical scale of the operation results. For setting methods, refer to the descriptions in "**Parameter Setting Method**". You can also enable the touch screen and use the "Pinch & Stretch" gesture to adjust the vertical scale.
- Press **More** → **AutoScale** to adjust the vertical scale and the offset of the operation results to the optimal value according to the current configuration, so as to better to observe.
- Press **More** → **Invert** to enable or disable the inverted display function of the waveform.
- Press **More** → **Expand** to expand or compress the math operation waveform around the "Center" or "GND".
- Press **More** → **Label** to set the label for math operation results. For details, refer to descriptions in "**Math Operation Label**".
- Press **More** → **Color Grade** to enable or disable the color grade display of the operation results. When enabled, different colors are displayed on the screen to indicate the times of data acquisition or acquisition probability.
- Press **More** → **Reset Color Grade** to clear the color grade display and display the color grade again.

## Subtraction

Subtracts the waveform voltage values of signal source B from that of source A point by point and displays the results.

Press **Math** → **Math1** → **Operator** to select "A-B":

- Press **Operation** continuously to enable or disable the subtraction operation function.
- Press **SourceA** and **SourceB** respectively, and rotate the multifunction knob  to select the channel for SourceA and Source B. Then press down the knob to select the channel. You can also press **SourceA** and **SourceB** continuously or enable the touch screen to select the channel. The available channels for SourceA and SourceB are CH1-CH4 and Ref1-Ref10.

**Note:** The available channels for Math2 are CH1-CH4, Ref1-Ref10 or Math1. The available channels for Math3 are CH1-CH4, Ref1-Ref10, Math1 or Math2. The available channels for Math4 are CH1-CH4, Ref1-Ref10, Math1, Math2 or Math3. Only the channels that have been enabled currently can be selected.

- Press **Offset** to set the vertical offset of the operation results. For setting methods, refer to the descriptions in "**Parameter Setting Method**". You can also enable the touch screen and use the "Drag" gesture to adjust the vertical offset.
- Press **Scale** to set the vertical scale of the operation results. For setting methods, refer to the descriptions in "**Parameter Setting Method**". You can also enable the touch screen and use the "Pinch & Stretch" gesture to adjust the vertical scale.
- Press **More** → **AutoScale** to adjust the vertical scale and offset of the operation results to the optimal value according to the current configuration, so as to better observe.
- Press **More** → **Invert** to enable or disable the inverted display function of the waveform.
- Press **More** → **Expand** to expand or compress the math operation waveform around the "Center" or "GND".
- Press **More** → **Label** to set the label for math operation results. For details, refer to descriptions in "**Math Operation Label**".
- Press **More** → **Color Grade** to enable or disable the color grade display of the operation results. When enabled, different colors are displayed on the screen to indicate the times of data acquisition or acquisition probability.
- Press **More** → **Reset Color Grade** to clear the color grade display and display the color grade again.

## Multiplication

Multiplies the waveform voltage values of signal source A and B point by point and displays the results.

Press **Math** → **Math1** → **Operator** to select "A×B":

- Press **Operation** continuously to enable or disable the multiplication operation function.
- Press **SourceA** and **SourceB** respectively, and rotate the multifunction knob  to select the channel for SourceA and Source B. Then press down the knob to select the channel. You can also press **SourceA** and **SourceB** continuously or enable the touch screen to select the channel. The available channels for SourceA and SourceB are CH1-CH4 and Ref1-Ref10.

**Note:** The available channels for Math2 are CH1-CH4, Ref1-Ref10 or Math1. The available channels for Math3 are CH1-CH4, Ref1-Ref10, Math1 or Math2.

The available channels for Math4 are CH1-CH4, Ref1-Ref10, Math1, Math2 or Math3. Only the channels that have been enabled currently can be selected.

- Press **Offset** to set the vertical offset of the operation results. For setting methods, refer to the descriptions in "**Parameter Setting Method**". You can also enable the touch screen and use the "Drag" gesture to adjust the vertical offset.
- Press **Scale** to set the vertical scale of the operation results. For setting methods, refer to the descriptions in "**Parameter Setting Method**". You can also enable the touch screen and use the "Pinch & Stretch" gesture to adjust the vertical scale.
- Press **More** → **AutoScale** to adjust the vertical scale and offset of the operation results to the optimal value according to the current configuration, so as to better observe.
- Press **More** → **Invert** to enable or disable the inverted display function of the waveform.
- Press **More** → **Expand** to expand or compress the measurement waveform around the "Center" or "GND".
- Press **More** → **Label** to set the label for math operation results. For details, refer to descriptions in "**Math Operation Label**".
- Press **More** → **Color Grade** to enable or disable the color grade display of the operation results. When enabled, different colors are displayed on the screen to indicate the times of data acquisition or acquisition probability.
- Press **More** → **Reset Color Grade** to clear the color grade display and display the color grade again.

## Division

Divides the waveform voltage values of signal source A by that of source B point by point and displays the results. It can be used to analyze the multiple relationships of waveforms of two channels.

**Note:** When the voltage of signal source B is 0 V, the division result is treated as 0.

Press **Math** → **Math1** → **Operator** to select "A÷B":

- Press **Operation** continuously to enable or disable the division operation function.
- Press **SourceA** and **SourceB** respectively, and rotate the multifunction knob  to select the channel for SourceA and Source B. Then press down the knob to select the channel. You can also press **SourceA** and **SourceB** continuously or enable the touch screen to select the channel. The available channels for SourceA and SourceB are CH1-CH4 and Ref1-Ref10.

**Note:** The available channels for Math2 are CH1-CH4, Ref1-Ref10 or Math1. The available channels for Math3 are CH1-CH4, Ref1-Ref10, Math1 or Math2.

The available channels for Math4 are CH1-CH4, Ref1-Ref10, Math1, Math2 or Math3. Only the channels that have been enabled currently can be selected.

- Press **Offset** to set the vertical offset of the operation results. For setting methods, refer to the descriptions in "**Parameter Setting Method**". You can also enable the touch screen and use the "Drag" gesture to adjust the vertical offset.
- Press **Scale** to set the vertical scale of the operation results. For setting methods, refer to the descriptions in "**Parameter Setting Method**". You can also enable the touch screen and use the "Pinch & Stretch" gesture to adjust the vertical scale.
- Press **More** → **AutoScale** to adjust the vertical scale and offset of the operation results to the optimal value according to the current configuration, so as to better observe.
- Press **More** → **Invert** to enable or disable the inverted display function of the waveform.
- Press **More** → **Expand** to expand or compress the measurement waveform around the "Center" or "GND".
- Press **More** → **Label** to set the label for math operation results. For details, refer to descriptions in "**Math Operation Label**".
- Press **More** → **Color Grade** to enable or disable the color grade display of the operation results. When enabled, different colors are displayed on the screen to indicate the times of data acquisition or acquisition probability.
- Press **More** → **Reset Color Grade** to clear the color grade display and display the color grade again.

## FFT

FFT (Fast Fourier Transform) is used to transform time-domain signals to frequency-domain components (frequency spectrum). MSO5000 oscilloscope provides FFT operation function which enables you to observe the time-domain waveform and spectrum of the signal at the same time. FFT operation can facilitate the following works:

- Measure harmonic components and distortion in the system;
- Display the characteristics of the noise in DC power;
- Analyze vibration.

Press **Math** → **Math1** → **Operator** to select "FFT":

- Press **Operation** continuously to enable or disable the FFT operation function. When enabled, the operation results are displayed as purple waveforms on the screen. At the same time, the parameters such as vertical scale, center

frequency, and resolution are displayed at the bottom of the screen, as shown in the following figure. Of which, FFT resolution is the quotient of the sample rate and the number of FFT points. If the number of FFT points is a fixed value (65535 at most), then the lower the sample rate, the higher the resolution.

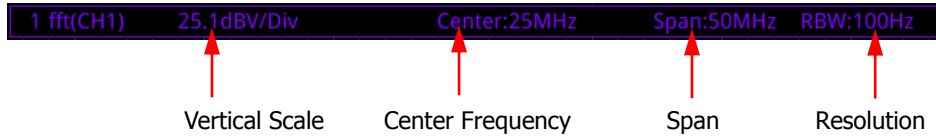

- Press **Source**, and rotate the multifunction knob  to select the channel. Then press down the knob to select the channel. You can also press **Source** continuously or enable the touch screen to select the channel. The available channels are CH1-CH4.
- Press **Offset** to set the vertical offset of the operation results. For setting methods, refer to the descriptions in "**Parameter Setting Method**". You can also enable the touch screen and use the "Drag" gesture to adjust the vertical offset.
- Press **Scale** to set the vertical scale of the operation results. For setting methods, refer to the descriptions in "**Parameter Setting Method**". You can also enable the touch screen and use the "Pinch & Stretch" gesture to adjust the vertical scale. If the source channel unit is set to "V", then the unit of the vertical scale is displayed as dBV. If you select other source channel unit, then the unit of the vertical scale is displayed as dB.
- Press **AutoScale** to adjust the vertical scale and offset of the operation results to the optimal value according to the current configuration, so as to better observe.
- Press **More** → **Unit** to select the vertical unit. The vertical unit can be set to dB/dBV or Vrms. The vertical amplitude can be expressed both in log form and linear form, with dB/dBV and Vrms as the unit respectively. If you need to display the FFT spectrum within a larger dynamic range, dB/dBV is recommended.
- Press **More** → **X** continuously to select "Span-Center" (frequency range to center frequency) or "Start-End" (start frequency to stop frequency).
  - "Span-Center" (frequency range to center frequency): the frequency range refers to the screen width, and you can divide the frequency range by 10 to obtain the frequency per division. Press **Span** to set the frequency range of the frequency-domain waveform. For setting methods, refer to descriptions in "**Parameter Setting Method**". Press **Center** to set the frequency of the frequency-domain waveform relative to the horizontal center of the screen. For setting methods, refer to descriptions in "**Parameter Setting Method**".
  - "Start-End" (start frequency to stop frequency): start frequency refers to the frequency at the left side of the screen. Press **Start** to set the start frequency of the frequency-domain waveform. For setting methods, refer to descriptions in "**Parameter Setting Method**". Stop frequency refers to

the frequency at the right side of the screen. Press **End** to set the stop frequency of the frequency-domain waveform. For setting methods, refer to descriptions in "**Parameter Setting Method**".

- Press **More** → **Peak Search** to enter the peak search menu. Press **Peak Search** continuously to enable or disable the peak search function. When enabled, the peak search results are displayed on the screen, as shown in the figure below. Enable the touch screen and tap the "Math" label at the top of the peak search results to switch among Math1-Math4.

Math1	Math2	Math3
	Freq	Amp
1	1.024MHz	-12.63dB
2	2.049MHz	-14.46dB
3	3.073MHz	-17.98dB
4	4.098MHz	-24.65dB
5	1.639MHz	-74.32dB
6	2.663MHz	-74.38dB
7	614.7kHz	-75.58dB





- Press **Peak Number**, then rotate the multifunction knob  or use the pop-up numeric keypad to set the number of peaks. The available range is from 1 to 15. By default, it is 5.
- Press **Threshold**, then rotate the multifunction knob  or use the pop-up numeric keypad to set the threshold of the peak.
- Press **Excursion**, then rotate the multifunction knob  or use the pop-up numeric keypad to set the excursion of the peak.
- Press **Table Order**, then rotate the multifunction knob  to select the sorting mode of the peak. Press down the knob to select it. You can also press **Table Order** continuously or enable the touch screen to select it. The available sorting mode is "Amp Order" and "Freq Order". By default, it is "Amp Order".
- Press **Export**, and the save setting menu is displayed. You can export the peak search results to the internal memory or the external USB storage device in CSV format. For detailed saving operation, refer to descriptions in "**Store and Load**".
- Press **More** → **Window** to select the desired window function. Spectral leakage can be considerably decreased when a window function is used. MSO5000 provides 6 FFT window functions (as shown in Table 6-1) which have different characteristics and are applicable to measuring different waveforms. You need to select the window function according to the characteristics of the waveform to be measured.

Table 6-1 Window Function

Window Function	Characteristics	Waveforms Applicable to the Window Function
Rectangular	Best frequency resolution Poorest amplitude resolution Similar to the situation when no window is applied.	Transient or short pulse, the signal levels before and after the multiplication are basically the same. Sine waveforms with the same amplitudes and rather similar frequencies. Wide band random noise with relatively slow change of waveform spectrum.
Blackman-Harris	Best amplitude resolution Poorest frequency resolution	Single frequency signal, searching for higher order harmonics.
Hanning	Better frequency resolution and poorer amplitude resolution compared with Rectangular	Sine, periodic, and narrow band random noise.
Hamming	A little bit better frequency resolution than Hanning	Transient or short pulse, the signal levels before and after the multiplication are rather different.
Flattop	Measure the signals accurately	Measure the signal that has no accurate reference and requires an accurate measurement
Triangle	Better frequency resolution	Measure the narrow band signal and that has strong noise interference

- For FFT math operation setting label, refer to descriptions in "**Math Operation Label**".
- Press **More** → **More** → **Color Grade** to enable or disable the color grade display of the FFT operation results. When enabled, different colors are displayed on the screen to indicate the times of data acquisition or acquisition probability.
- Press **More** → **More** → **Reset Color Grade** to clear the color grade display and display the color grade again.

**Tip**

FFT shortcut operation: Enable the touch screen, and then tap the function navigation icon  at the lower-left corner of the screen to open the function navigation. Then, tap the "FFT" icon to open the FFT menu. This oscilloscope supports 4 FFTs: FFT1, FFT2, FFT3, and FFT4. For details, refer to the descriptions in this section.

## "AND" Operation

Performs logic "AND" operation on the waveform voltage values of the specified sources point by point and displays the results. In operation, when the voltage value of the source channel is greater than the threshold of the corresponding channel, it is regarded as logic "1"; otherwise it is logic "0". The results of logic AND operation of two binary bits are shown in Table 6-2.

Table 6-2 Logic "AND" Operation

A	B	A&&B
0	0	0
0	1	0
1	0	0
1	1	1

Press **Math** → **Math1** → **Operator** to select "A&&B":

- Press **Operation** continuously to enable or disable the "AND" operation function.
- Press **SourceA** and **SourceB** respectively, and rotate the multifunction knob  to select the channel for SourceA and Source B. Then press down the knob to select the channel. You can also press **SourceA** and **SourceB** continuously or enable the touch screen to select the channel. The available channels for SourceA and SourceB are CH1-CH4 and D0-D15.

**Note:** Only the channels that have been enabled currently can be selected.



- If Source A (or Source B) selects CH1, press **More** → **Thre.CH1** to set the threshold of Source A (or Source B) in logic operation. For setting methods, refer to descriptions in "**Parameter Setting Method**".
- If Source A (or Source B) selects CH2, press **More** → **Thre.CH2** to set the threshold of Source A (or Source B) in logic operation. For setting methods, refer to descriptions in "**Parameter Setting Method**".
- If Source A (or Source B) selects CH3, press **More** → **Thre.CH3** to set the threshold of Source A (or Source B) in logic operation. For setting methods, refer to descriptions in "**Parameter Setting Method**".
- If Source A (or Source B) selects CH4, press **More** → **Thre.CH4** to set the



threshold of Source A (or Source B) in logic operation. For setting methods, refer to descriptions in "**Parameter Setting Method**".

### Tip

The thresholds of the digital channels (D0-D15) are respectively set in the LA module.

- Press **Offset**, and then rotate the multifunction knob  to adjust the vertical offset of the operation results. You can also enable the touch screen and use the "Drag" gesture to adjust the vertical offset.
- Press **Size**, and then rotate the multifunction knob  to select the waveform size. Press down the knob to select it. You can also press **Size** continuously or enable the touch screen to select it. The available sizes include "Small", "Medium", and "Large".
- Press **More** → **AutoScale** to adjust the vertical scale and offset of the operation results to the optimal value according to the current configuration, so as to better observe.
- Press **More** → **Sensitivity** to set the sensitivity of the digital signal converted from the analog signal on the source. For setting methods, refer to descriptions in "**Parameter Setting Method**".
- Press **More** → **Label** to set the label for math operation results. For details, refer to descriptions in "**Math Operation Label**".

## "OR" Operation

Performs logic "OR" operation on the waveform voltage values of the specified sources point by point and displays the results. In operation, when the voltage value of the source channel is greater than the threshold of the corresponding channel, it is regarded as logic "1"; otherwise it is logic "0". The results of logic OR operation of two binary bits are as shown in Table 6-3.

Table 6-3 Logic "OR" Operation



A	B	A  B
0	0	0
0	1	1
1	0	1
1	1	1

Press **Math** → **Math1** → **Operator** to select "A||B":

- Press **Operation** continuously to enable or disable the "OR" operation function.
- Press **SourceA** and **SourceB** respectively, and rotate the multifunction knob

 to select the channel for SourceA and Source B. Then press down the knob to select the channel. You can also press **SourceA** and **SourceB** continuously or enable the touch screen to select the channel.

**Note:** Only the channels that have been enabled currently can be selected.

- If Source A (or Source B) selects CH1, press **More** → **Thre.CH1** to set the threshold of Source A (or Source B) in logic operation. For setting methods, refer to descriptions in "**Parameter Setting Method**".
- If Source A (or Source B) selects CH2, press **More** → **Thre.CH2** to set the threshold of Source A (or Source B) in logic operation. For setting methods, refer to descriptions in "**Parameter Setting Method**".
- If Source A (or Source B) selects CH3, press **More** → **Thre.CH3** to set the threshold of Source A (or Source B) in logic operation. For setting methods, refer to descriptions in "**Parameter Setting Method**".
- If Source A (or Source B) selects CH4, press **More** → **Thre.CH4** to set the threshold of Source A (or Source B) in logic operation. For setting methods, refer to descriptions in "**Parameter Setting Method**".
- Press **Offset**, and then rotate the multifunction knob  to adjust the vertical offset of the operation results. You can also enable the touch screen and use the "Drag" gesture to adjust the vertical offset.
- Press **Size**, and then rotate the multifunction knob  to select the waveform size. Press down the knob to select it. You can also press **Size** continuously or enable the touch screen to select it. The available sizes include "Small", "Medium", and "Large".
- Press **More** → **AutoScale** to adjust the vertical scale and offset of the operation results to the optimal value according to the current configuration, so as to better observe.
- Press **More** → **Sensitivity** to set the sensitivity of the digital signal converted from the analog signal on the source. For setting methods, refer to descriptions in "**Parameter Setting Method**".
- Press **More** → **Label** to set the label for math operation results. For details, refer to descriptions in "**Math Operation Label**".

## "XOR" Operation

Performs logic "XOR" operation on the waveform voltage values of the specified sources point by point and displays the results. In operation, when the voltage value of the source channel is greater than the threshold of the corresponding channel, it is regarded as logic "1"; otherwise it is logic "0". The results of logic XOR operation of two binary bits are as shown in Table 6-4.



Table 6-4 Logic "XOR" Operation

A	B	A^B
0	0	0
0	1	1
1	0	1
1	1	0

Press **Math** → **Math1** → **Operator** to select "A^B":

- Press **Operation** continuously to enable or disable the "XOR" operation function.
- Press **SourceA** and **SourceB** respectively, and rotate the multifunction knob  to select the channel for SourceA and Source B. Then press down the knob to select the channel. You can also press **SourceA** and **SourceB** continuously or enable the touch screen to select the channel.
 

**Note:** Only the channels that have been enabled currently can be selected.

  - If Source A (or Source B) selects CH1, press **More** → **Thre.CH1** to set the threshold of Source A (or Source B) in logic operation. For setting methods, refer to descriptions in "**Parameter Setting Method**".
  - If Source A (or Source B) selects CH2, press **More** → **Thre.CH2** to set the threshold of Source A (or Source B) in logic operation. For setting methods, refer to descriptions in "**Parameter Setting Method**".
  - If Source A (or Source B) selects CH3, press **More** → **Thre.CH3** to set the threshold of Source A (or Source B) in logic operation. For setting methods, refer to descriptions in "**Parameter Setting Method**".
  - If Source A (or Source B) selects CH4, press **More** → **Thre.CH4** to set the threshold of Source A (or Source B) in logic operation. For setting methods, refer to descriptions in "**Parameter Setting Method**".
- Press **Offset**, and then rotate the multifunction knob  to adjust the vertical offset of the operation results. You can also enable the touch screen and use the "Drag" gesture to adjust the vertical offset.
- Press **Size**, and then rotate the multifunction knob  to select the waveform size. Press down the knob to select it. You can also press **Size** continuously or enable the touch screen to select it. The available sizes include "Small", "Medium", and "Large".
- Press **More** → **AutoScale** to adjust the vertical scale and offset of the operation results to the optimal value according to the current configuration, so as to better observe.
- Press **More** → **Sensitivity** to set the sensitivity of the digital signal converted from the analog signal on the source. For setting methods, refer to descriptions in "**Parameter Setting Method**".
- Press **More** → **Label** to set the label for math operation results. For details, refer to descriptions in "**Math Operation Label**".

## "NOT" Operation

Performs logic "NOT" operation on the waveform voltage values of the specified sources point by point and displays the results. In operation, when the voltage value of the source channel is greater than the threshold of the corresponding channel, it is regarded as logic "1"; otherwise it is logic "0". The results of logic "NOT" operation of two binary bits are as shown in Table 6-5.



Table 6-5 Logic "NOT" Operation

A	!A
0	1
1	0

Press **Math** → **Math1** → **Operator** to select "!A":

- Press **Operation** continuously to enable or disable the "NOT" operation function.
- Press **SourceA**, and rotate the multifunction knob  to select the channel for SourceA. Then press down the knob to select the channel. You can also press **SourceA** continuously or enable the touch screen to select the channel.
 

**Note:** Only the channels that have been enabled currently can be selected.

  - If Source A (or Source B) selects CH1, press **More** → **Thre.CH1** to set the threshold of Source A (or Source B) in logic operation. For setting methods, refer to descriptions in "**Parameter Setting Method**".
  - If Source A (or Source B) selects CH2, press **More** → **Thre.CH2** to set the threshold of Source A (or Source B) in logic operation. For setting methods, refer to descriptions in "**Parameter Setting Method**".
  - If Source A (or Source B) selects CH3, press **More** → **Thre.CH3** to set the threshold of Source A (or Source B) in logic operation. For setting methods, refer to descriptions in "**Parameter Setting Method**".
  - If Source A (or Source B) selects CH4, press **More** → **Thre.CH4** to set the threshold of Source A (or Source B) in logic operation. For setting methods, refer to descriptions in "**Parameter Setting Method**".
- Press **Offset**, and then rotate the multifunction knob  to adjust the vertical offset of the operation results. You can also enable the touch screen and use the "Drag" gesture to adjust the vertical offset.
- Press **Size**, and then rotate the multifunction knob  to select the waveform size. Press down the knob to select it. You can also press **Size** continuously or enable the touch screen to select it. The available sizes include "Small", "Medium", and "Large".
- Press **AutoScale** to adjust the vertical scale and offset of the operation results to the optimal value according to the current configuration, so as to better observe.

- Press **More** → **Sensitivity** to set the sensitivity of the digital signal converted from the analog signal on the source. For setting methods, refer to descriptions in "**Parameter Setting Method**".
- Press **More** → **Label** to set the label for math operation results. For details, refer to descriptions in "**Math Operation Label**".

## Intg

Calculates the integral of the selected source. For example, you can use integral to measure the area under a waveform or the pulse energy.

Press **Math** → **Math1** → **Operator** to select "Intg":

- Press **Operation** continuously to enable or disable the "Intg" operation function.
- Press **SourceA**, and rotate the multifunction knob  to select the channel for SourceA. Then press down the knob to select the channel. You can also press **SourceA** continuously or enable the touch screen to select the channel. The available channels include CH1-CH4 and Ref1-Ref10.  
**Note:** The available channels for Math2 are CH1-CH4, Ref1-Ref10 or Math1. The available channels for Math3 are CH1-CH4, Ref1-Ref10, Math1 or Math2. The available channels for Math4 are CH1-CH4, Ref1-Ref10, Math1, Math2 or Math3. Only the channels that have been enabled currently can be selected.
- Press **Offset** to set the vertical offset of the operation results. For setting methods, refer to the descriptions in "**Parameter Setting Method**". You can also enable the touch screen and use the "Drag" gesture to adjust the vertical offset.
- Press **Scale** to set the vertical scale of the operation results. For setting methods, refer to the descriptions in "**Parameter Setting Method**". You can also enable the touch screen and use the "Pinch & Stretch" gesture to adjust the vertical scale.
- Press **AutoScale** to adjust the vertical scale and offset of the operation results to an optimal value based on the current configuration, so as to better observe.
- Press **More** → **Bias** to set the DC offset correction factor for the input signal. Note that this parameter can only be set by using the numeric keypad.
- Press **More** → **Invert** to enable or disable the inverted display function of the waveform.
- Press **More** → **Label** to set the label for math operation results. For details, refer to descriptions in "**Math Operation Label**".
- Press **More** → **Color Grade** to enable or disable the color grade display of the operation results. When enabled, different colors are displayed on the screen to indicate the times of data acquisition or acquisition probability.
- Press **More** → **Reset Color Grade** to clear the color grade display and display the color grade again.

## Diff

Calculates the discrete time derivative of the selected source. For example, you can use differentiate to measure the instantaneous slope of a waveform.

Press **Math** → **Math1** → **Operator** to select "Diff":

- Press **Operation** continuously to enable or disable the "Diff" operation function.
- Press **SourceA**, and rotate the multifunction knob  to select the channel for SourceA. Then press down the knob to select the channel. You can also press **SourceA** continuously or enable the touch screen to select the channel. The available channels for SourceA are CH1-CH4 and Ref1-Ref10.  
**Note:** The available channels for Math2 are CH1-CH4, Ref1-Ref10 or Math1. The available channels for Math3 are CH1-CH4, Ref1-Ref10, Math1 or Math2. The available channels for Math4 are CH1-CH4, Ref1-Ref10, Math1, Math2 or Math3. Only the channels that have been enabled currently can be selected.
- Press **Offset** to set the vertical offset of the operation results. For setting methods, refer to the descriptions in "**Parameter Setting Method**". You can also enable the touch screen and use the "Drag" gesture to adjust the vertical offset.
- Press **Scale** to set the vertical scale of the operation results. For setting methods, refer to the descriptions in "**Parameter Setting Method**". You can also enable the touch screen and use the "Pinch & Stretch" gesture to adjust the vertical scale.
- Press **AutoScale** to adjust the vertical scale and offset of the operation results to an optimal value based on the current configuration, so as to better observe.
- Press **More** → **Smooth** to set the number of smoothing times in differential operation. For setting methods, refer to descriptions in "**Parameter Setting Method**".  
**Note:** As the high-frequency component of waveform data has a great impact on the differential operation, you need to adjust the parameter "Smooth" to a larger value, so as to restore the low-frequency component.
- Press **More** → **Invert** to enable or disable the inverted display function of the waveform.
- Press **More** → **Label** to set the label for math operation results. For details, refer to descriptions in "**Math Operation Label**".
- Press **More** → **Color Grade** to enable or disable the color grade display of the operation results. When enabled, different colors are displayed on the screen to indicate the times of data acquisition or acquisition probability.
- Press **More** → **Reset Color Grade** to clear the color grade display and display the color grade again.

**Tip**

Because differentiation is very sensitive to noise, it is helpful to set acquisition mode to "Average".

## Sqrt

Calculates the square root of the selected source point by point and displays the results.

Press **Math** → **Math1** → **Operator** to select "Sqrt":

- Press **Operation** continuously to enable or disable the "Sqrt" operation function.
- Press **SourceA**, and rotate the multifunction knob  to select the channel for SourceA. Then press down the knob to select the channel. You can also press **SourceA** continuously or enable the touch screen to select the channel. The available channels for SourceA are CH1-CH4 and Ref1-Ref10.  
**Note:** The available channels for Math2 are CH1-CH4, Ref1-Ref10 or Math1. The available channels for Math3 are CH1-CH4, Ref1-Ref10, Math1 or Math2. The available channels for Math4 are CH1-CH4, Ref1-Ref10, Math1, Math2 or Math3. Only the channels that have been enabled currently can be selected.
- Press **Offset** to set the vertical offset of the operation results. For setting methods, refer to the descriptions in "**Parameter Setting Method**". You can also enable the touch screen and use the "Drag" gesture to adjust the vertical offset.
- Press **Scale** to set the vertical scale of the operation results. For setting methods, refer to the descriptions in "**Parameter Setting Method**". You can also enable the touch screen and use the "Pinch & Stretch" gesture to adjust the vertical scale.
- Press **AutoScale** to adjust the vertical scale and offset of the operation results to an optimal value based on the current configuration, so as to better observe.
- Press **More** → **Invert** to enable or disable the inverted display function of the waveform.
- Press **More** → **Label** to set the label for math operation results. For details, refer to descriptions in "**Math Operation Label**".
- Press **More** → **Color Grade** to enable or disable the color grade display of the operation results. When enabled, different colors are displayed on the screen to indicate the times of data acquisition or acquisition probability.
- Press **More** → **Reset Color Grade** to clear the color grade display and display the color grade again.

## Lg (Base 10 Exponential)

Calculates the base 10 exponential of the selected source point by point and displays the results.

Press **Math** → **Math1** → **Operator** to select "Lg":

- Press **Operation** continuously to enable or disable the "Lg" operation function.
- Press **SourceA**, and rotate the multifunction knob  to select the channel for SourceA. Then press down the knob to select the channel. You can also press **SourceA** continuously or enable the touch screen to select the channel. The available channels for SourceA are CH1-CH4 and Ref1-Ref10.  
**Note:** The available channels for Math2 are CH1-CH4, Ref1-Ref10 or Math1. The available channels for Math3 are CH1-CH4, Ref1-Ref10, Math1 or Math2. The available channels for Math4 are CH1-CH4, Ref1-Ref10, Math1, Math2 or Math3. Only the channels that have been enabled currently can be selected.
- Press **Offset** to set the vertical offset of the operation results. For setting methods, refer to the descriptions in "**Parameter Setting Method**". You can also enable the touch screen and use the "Drag" gesture to adjust the vertical offset.
- Press **Scale** to set the vertical scale of the operation results. For setting methods, refer to the descriptions in "**Parameter Setting Method**". You can also enable the touch screen and use the "Pinch & Stretch" gesture to adjust the vertical scale.
- Press **AutoScale** to adjust the vertical scale and offset of the operation results to an optimal value based on the current configuration, so as to better observe.
- Press **More** → **Invert** to enable or disable the inverted display function of the waveform.
- Press **More** → **Label** to set the label for math operation results. For details, refer to descriptions in "**Math Operation Label**".
- Press **More** → **Color Grade** to enable or disable the color grade display of the operation results. When enabled, different colors are displayed on the screen to indicate the times of data acquisition or acquisition probability.
- Press **More** → **Reset Color Grade** to clear the color grade display and display the color grade again.

## Ln

Calculates the natural logarithm (Ln) of the selected source point by point and displays the results.

Press **Math** → **Math1** → **Operator** to select "Ln":



- Press **Operation** continuously to enable or disable the "Ln" operation function.
- Press **SourceA**, and rotate the multifunction knob  to select the channel for SourceA. Then press down the knob to select the channel. You can also press **SourceA** continuously or enable the touch screen to select the channel. The available channels for SourceA are CH1-CH4 and Ref1-Ref10.  
**Note:** The available channels for Math2 are CH1-CH4, Ref1-Ref10 or Math1. The available channels for Math3 are CH1-CH4, Ref1-Ref10, Math1 or Math2. The available channels for Math4 are CH1-CH4, Ref1-Ref10, Math1, Math2 or Math3. Only the channels that have been enabled currently can be selected.
- Press **Offset** to set the vertical offset of the operation results. For setting methods, refer to the descriptions in "**Parameter Setting Method**". You can also enable the touch screen and use the "Drag" gesture to adjust the vertical offset.
- Press **Scale** to set the vertical scale of the operation results. For setting methods, refer to the descriptions in "**Parameter Setting Method**". You can also enable the touch screen and use the "Pinch & Stretch" gesture to adjust the vertical scale.
- Press **AutoScale** to adjust the vertical scale and offset of the operation results to an optimal value based on the current configuration, so as to better observe.
- Press **More** → **Invert** to enable or disable the inverted display function of the waveform.
- Press **More** → **Label** to set the label for math operation results. For details, refer to descriptions in "**Math Operation Label**".
- Press **More** → **Color Grade** to enable or disable the color grade display of the operation results. When enabled, different colors are displayed on the screen to indicate the times of data acquisition or acquisition probability.
- Press **More** → **Reset Color Grade** to clear the color grade display and display the color grade again.

## Exp

Calculates the exponential of the selected source point by point and displays the results.

Press **Math** → **Math1** → **Operator** to select "Exp":

- Press **Operation** continuously to enable or disable the "Exp" operation function.
- Press **SourceA**, and rotate the multifunction knob  to select the channel for SourceA. Then press down the knob to select the channel. You can also press **SourceA** continuously or enable the touch screen to select the channel. The available channels for SourceA are CH1-CH4 and Ref1-Ref10.  
**Note:** The available channels for Math2 are CH1-CH4, Ref1-Ref10 or Math1. The available channels for Math3 are CH1-CH4, Ref1-Ref10, Math1 or Math2.

The available channels for Math4 are CH1-CH4, Ref1-Ref10, Math1, Math2 or Math3. Only the channels that have been enabled currently can be selected.

- Press **Offset** to set the vertical offset of the operation results. For setting methods, refer to the descriptions in "**Parameter Setting Method**". You can also enable the touch screen and use the "Drag" gesture to adjust the vertical offset.
- Press **Scale** to set the vertical scale of the operation results. For setting methods, refer to the descriptions in "**Parameter Setting Method**". You can also enable the touch screen and use the "Pinch & Stretch" gesture to adjust the vertical scale.
- Press **AutoScale** to adjust the vertical scale and offset of the operation results to an optimal value based on the current configuration, so as to better observe.
- Press **More** → **Invert** to enable or disable the inverted display function of the waveform.
- Press **More** → **Label** to set the label for math operation results. For details, refer to descriptions in "**Math Operation Label**".
- Press **More** → **Color Grade** to enable or disable the color grade display of the operation results. When enabled, different colors are displayed on the screen to indicate the times of data acquisition or acquisition probability.
- Press **More** → **Reset Color Grade** to clear the color grade display and display the color grade again.

## Abs

Calculates the absolute value of the selected source and displays the results.

Press **Math** → **Math1** → **Operator** to select "Abs":

- Press **Operation** continuously to enable or disable the "Abs" operation function.
  - Press **SourceA**, and rotate the multifunction knob  to select the channel for SourceA. Then press down the knob to select the channel. You can also press **SourceA** continuously or enable the touch screen to select the channel. The available channels for SourceA are CH1-CH4 and Ref1-Ref10.
- Note:** The available channels for Math2 are CH1-CH4, Ref1-Ref10 or Math1. The available channels for Math3 are CH1-CH4, Ref1-Ref10, Math1 or Math2. The available channels for Math4 are CH1-CH4, Ref1-Ref10, Math1, Math2 or Math3. Only the channels that have been enabled currently can be selected.
- Press **Offset** to set the vertical offset of the operation results. For setting methods, refer to the descriptions in "**Parameter Setting Method**". You can also enable the touch screen and use the "Drag" gesture to adjust the vertical offset.
  - Press **Scale** to set the vertical scale of the operation results. For setting methods, refer to the descriptions in "**Parameter Setting Method**". You can also enable

the touch screen and use the "Pinch & Stretch" gesture to adjust the vertical scale.

- Press **AutoScale** to adjust the vertical scale and offset of the operation results to an optimal value based on the current configuration, so as to better observe.
- Press **More** → **Invert** to enable or disable the inverted display function of the waveform.
- Press **More** → **Label** to set the label for math operation results. For details, refer to descriptions in "**Math Operation Label**".
- Press **More** → **Color Grade** to enable or disable the color grade display of the operation results. When enabled, different colors are displayed on the screen to indicate the times of data acquisition or acquisition probability.
- Press **More** → **Reset Color Grade** to clear the color grade display and display the color grade again.

## Low Pass

Only allows the signals whose frequencies are lower than the current upper limit frequency to pass.

Press **Math** → **Math1** → **Operator** to select "LowPass":

- Press **Operation** continuously to enable or disable the "LowPass" operation function.
- Press **SourceA**, and rotate the multifunction knob  to select the channel for SourceA. Then press down the knob to select the channel. You can also press **SourceA** continuously or enable the touch screen to select the channel. The available channels for SourceA are CH1-CH4 and Ref1-Ref10.  
**Note:** The available channels for Math2 are CH1-CH4, Ref1-Ref10 or Math1. The available channels for Math3 are CH1-CH4, Ref1-Ref10, Math1 or Math2. The available channels for Math4 are CH1-CH4, Ref1-Ref10, Math1, Math2 or Math3. Only the channels that have been enabled currently can be selected.
- Press **Offset** to set the vertical offset of the operation results. For setting methods, refer to the descriptions in "**Parameter Setting Method**". You can also enable the touch screen and use the "Drag" gesture to adjust the vertical offset.
- Press **Scale** to set the vertical scale of the operation results. For setting methods, refer to the descriptions in "**Parameter Setting Method**". You can also enable the touch screen and use the "Pinch & Stretch" gesture to adjust the vertical scale.
- Press **ωc** to set the upper limit frequency. For setting methods, refer to descriptions in "**Parameter Setting Method**".
- Press **More** → **AutoScale** to adjust the vertical scale and offset of the operation

results to an optimal value based on the current configuration, so as to better observe.

- Press **More** → **Invert** to enable or disable the inverted display function of the waveform.
- Press **More** → **Label** to set the label for math operation results. For details, refer to descriptions in "**Math Operation Label**".
- Press **More** → **Color Grade** to enable or disable the color grade display of the operation results. When enabled, different colors are displayed on the screen to indicate the times of data acquisition or acquisition probability.
- Press **More** → **Reset Color Grade** to clear the color grade display and display the color grade again.

## High Pass

Only allows the signals whose frequencies are higher than the current lower limit frequency to pass.

Press **Math** → **Math1** → **Operator** to select "HighPass":

- Press **Operation** continuously to enable or disable the "HighPass" operation function.
  - Press **SourceA**, and rotate the multifunction knob  to select the channel for SourceA. Then press down the knob to select the channel. You can also press **SourceA** continuously or enable the touch screen to select the channel. The available channels for SourceA are CH1-CH4 and Ref1-Ref10.
- Note:** The available channels for Math2 are CH1-CH4, Ref1-Ref10 or Math1. The available channels for Math3 are CH1-CH4, Ref1-Ref10, Math1 or Math2. The available channels for Math4 are CH1-CH4, Ref1-Ref10, Math1, Math2 or Math3. Only the channels that have been enabled currently can be selected.
- Press **Offset** to set the vertical offset of the operation results. For setting methods, refer to the descriptions in "**Parameter Setting Method**". You can also enable the touch screen and use the "Drag" gesture to adjust the vertical offset.
  - Press **Scale** to set the vertical scale of the operation results. For setting methods, refer to the descriptions in "**Parameter Setting Method**". You can also enable the touch screen and use the "Pinch & Stretch" gesture to adjust the vertical scale.
  - Press **ωc** to set the lower limit frequency. For setting methods, refer to descriptions in "**Parameter Setting Method**".
  - Press **More** → **AutoScale** to adjust the vertical scale and offset of the operation results to an optimal value based on the current configuration, so as to better observe.
  - Press **More** → **Invert** to enable or disable the inverted display function of the

waveform.

- Press **More** → **Label** to set the label for math operation results. For details, refer to descriptions in "**Math Operation Label**".
- Press **More** → **Color Grade** to enable or disable the color grade display of the operation results. When enabled, different colors are displayed on the screen to indicate the times of data acquisition or acquisition probability.
- Press **More** → **Reset Color Grade** to clear the color grade display and display the color grade again.

## Band Pass

Only allows the signals whose frequencies are higher than the current lower limit frequency and lower than the current upper limit frequency to pass.

Press **Math** → **Math1** → **Operator** to select "BandPass":

- Press **Operation** continuously to enable or disable the "BandPass" operation function.
- Press **SourceA**, and rotate the multifunction knob  to select the channel for SourceA. Then press down the knob to select the channel. You can also press **SourceA** continuously or enable the touch screen to select the channel. The available channels for SourceA are CH1-CH4 and Ref1-Ref10.  
**Note:** The available channels for Math2 are CH1-CH4, Ref1-Ref10 or Math1. The available channels for Math3 are CH1-CH4, Ref1-Ref10, Math1 or Math2. The available channels for Math4 are CH1-CH4, Ref1-Ref10, Math1, Math2 or Math3. Only the channels that have been enabled currently can be selected.
- Press **Offset** to set the vertical offset of the operation results. For setting methods, refer to the descriptions in "**Parameter Setting Method**". You can also enable the touch screen and use the "Drag" gesture to adjust the vertical offset.
- Press **Scale** to set the vertical scale of the operation results. For setting methods, refer to the descriptions in "**Parameter Setting Method**". You can also enable the touch screen and use the "Pinch & Stretch" gesture to adjust the vertical scale.
- Press **AutoScale** to adjust the vertical scale and offset of the operation results to an optimal value based on the current configuration, so as to better observe.
- Press **More** → **ωc1** to set the lower limit frequency. For setting methods, refer to descriptions in "**Parameter Setting Method**".
- Press **More** → **ωc2** to set the upper limit frequency. For setting methods, refer to descriptions in "**Parameter Setting Method**".
- Press **More** → **Invert** to enable or disable the inverted display function of the waveform.
- Press **More** → **Label** to set the label for math operation results. For details,

refer to descriptions in "**Math Operation Label**".

- Press **More** → **Color Grade** to enable or disable the color grade display of the operation results. When enabled, different colors are displayed on the screen to indicate the times of data acquisition or acquisition probability.
- Press **More** → **Reset Color Grade** to clear the color grade display and display the color grade again.

## Band Stop

Only allows the signals whose frequencies are lower than the current lower limit frequency and higher than the current upper limit frequency to pass.

Press **Math** → **Math1** → **Operator** to select "BandStop":

- Press **Operation** continuously to enable or disable the "BandStop" operation function.
- Press **SourceA**, and rotate the multifunction knob  to select the channel for SourceA. Then press down the knob to select the channel. You can also press **SourceA** continuously or enable the touch screen to select the channel. The available channels for SourceA are CH1-CH4 and Ref1-Ref10.  
**Note:** The available channels for Math2 are CH1-CH4, Ref1-Ref10 or Math1. The available channels for Math3 are CH1-CH4, Ref1-Ref10, Math1 or Math2. The available channels for Math4 are CH1-CH4, Ref1-Ref10, Math1, Math2 or Math3. Only the channels that have been enabled currently can be selected.
- Press **Offset** to set the vertical offset of the operation results. For setting methods, refer to the descriptions in "**Parameter Setting Method**". You can also enable the touch screen and use the "Drag" gesture to adjust the vertical offset.
- Press **Scale** to set the vertical scale of the operation results. For setting methods, refer to the descriptions in "**Parameter Setting Method**". You can also enable the touch screen and use the "Pinch & Stretch" gesture to adjust the vertical scale.
- Press **AutoScale** to adjust the vertical scale and offset of the operation results to an optimal value based on the current configuration, so as to better observe.
- Press **More** → **ωc1** to set the lower limit frequency. For setting methods, refer to descriptions in "**Parameter Setting Method**".
- Press **More** → **ωc2** to set the upper limit frequency. For setting methods, refer to descriptions in "**Parameter Setting Method**".
- Press **More** → **Invert** to enable or disable the inverted display function of the waveform.
- Press **More** → **Label** to set the label for math operation results. For details, refer to descriptions in "**Math Operation Label**".
- Press **More** → **Color Grade** to enable or disable the color grade display of the

operation results. When enabled, different colors are displayed on the screen to indicate the times of data acquisition or acquisition probability.

- Press **More** → **Reset Color Grade** to clear the color grade display and display the color grade again.

## AX+B

Applies a linear function to the selected source, and displays the results.

Press **Math** → **Math1** → **Operator** to select "AX+B":

- Press **Operation** continuously to enable or disable the "AX+B" operation function.
- Press **SourceA**, and rotate the multifunction knob  to select the channel for SourceA. Then press down the knob to select the channel. You can also press **SourceA** continuously or enable the touch screen to select the channel. The available channels for SourceA are CH1-CH4 and Ref1-Ref10.  
**Note:** The available channels for Math2 are CH1-CH4, Ref1-Ref10 or Math1. The available channels for Math3 are CH1-CH4, Ref1-Ref10, Math1 or Math2. The available channels for Math4 are CH1-CH4, Ref1-Ref10, Math1, Math2 or Math3. Only the channels that have been enabled currently can be selected.
- Press **Offset** to set the vertical offset of the operation results. For setting methods, refer to the descriptions in "**Parameter Setting Method**". You can also enable the touch screen and use the "Drag" gesture to adjust the vertical offset.
- Press **Scale** to set the vertical scale of the operation results. For setting methods, refer to the descriptions in "**Parameter Setting Method**". You can also enable the touch screen and use the "Pinch & Stretch" gesture to adjust the vertical scale.
- Press **AutoScale** to adjust the vertical scale and offset of the operation results to an optimal value based on the current configuration, so as to better observe.
- Press **More** → **A** to set the value of A. Note that this parameter can only be set by using the numeric keypad.
- Press **More** → **B** to set the value of B. Note that this parameter can only be set by using the numeric keypad.
- Press **More** → **Invert** to enable or disable the inverted display function of the waveform.
- Press **More** → **Label** to set the label for math operation results. For details, refer to descriptions in "**Math Operation Label**".
- Press **More** → **Color Grade** to enable or disable the color grade display of the operation results. When enabled, different colors are displayed on the screen to indicate the times of data acquisition or acquisition probability.

- Press **More** → **Reset Color Grade** to clear the color grade display and display the color grade again.

## Math Operation Label

Press **Label** to enter the label setting menu.

- Press **Display** continuously to enable or disable the label display of the waveform. If it is enabled, the label will be displayed at the left side of the waveform.
- Press **Library** to select the preset waveform label, including ADD, SUB, MUL, DIV, FFT, AND, OR, XOR, NOT, Intg, Diff, Sqrt, Lg, Ln, Exp, Abs, LPas, HPas, BPa, BStop, and AX+B.
- Press **Label**, and the label editing interface is automatically displayed. You can input the label manually. For details, refer to descriptions in "**Channel Label**".







## Auto Measurement

MSO5000 provides auto measurements for 41 waveform parameters, as well as the statistics and analysis of the measurement results.

### Quick Measurement after AUTO

When the oscilloscope is correctly connected and has detected a valid input signal, press **AUTO** to enable the waveform auto setting function and open the auto setting function menu.

- : Press this key, and then the complete single period of the signal is displayed automatically on the screen. Meanwhile, the system will make measurements for the "frequency" of the currently displayed waveforms in a complete single period. The measurement results are displayed at the bottom of the screen.
- : Press this key, and then multiple periods of the signal are displayed automatically on the screen. Meanwhile, the system will make measurements for the "frequency" of the currently displayed waveforms in a multiple periods. The measurement results are displayed at the bottom of the screen.
- : Press this key, and then one rising edge of the signal is displayed automatically on the screen. Meanwhile, the system will make measurements for the "rise time" of the currently displayed rising edge. The measurement results are displayed at the bottom of the screen. By default, it is intended for the fast edge signal.
- : Press this key, and then one falling edge of the signal is displayed automatically on the screen. Meanwhile, the system will make measurements for the "fall time" of the currently displayed falling edge. The measurement results are displayed at the bottom of the screen. By default, it is intended for the fast edge signal.
- : press this key, and the system returns to the last set menu.
- Press **Option** to enter the auto setting function menu.
  - Press **Lock** to lock the AUTO function. To unlock the AUTO function, use the following two methods:
    - Method 1: Send the remote command :SYSTEM:AUTOscale ON to unlock the AUTO function.
    - Method 2: Press **Lock** again, then a password input dialog box is displayed. Input the password. By default, there is no password, and pressing **OK** directly can unlock the function.

**Tip**

If you lock the Auto function and then exit the auto setting function menu, you can press **Utility** → **More** → **Auto Config** to enter the auto setting function menu again to unlock the Auto function.

- Press **Peak to Peak** to enable or disable the peak-peak priority setting. This function is intended for the shifted signal. If there is a large deviation, you can view the signal waveform in priority when you enable the function.
- Press **CH** to select "All" or "Open".  
If you select "All", press **AUTO** and the system will test the 4 analog channels (CH1-CH4) in sequence. If no signal is found on the channel, then the channel is disabled; if a signal is found on the channel, adjust the channel to an optimal scale to display the signal.  
If you select "Open", press **AUTO** and the system will only test the enabled channels.
- Press **Overlay** to enable or disable the waveform overlay display function. If enabled, waveforms of different channels will be displayed in the same position of the screen; if disabled, waveforms of different channels will be displayed on the screen from top to bottom in sequence.
- Press **Coupling** to enable or disable the coupling hold function. If enabled, after you press **AUTO**, the settings for the channel coupling remain unchanged; if disabled, then the channel coupling is, by default, set to "DC".
- Press **Password**, and then the password reset dialog box is displayed, as shown in the figure below. You can reset the password.

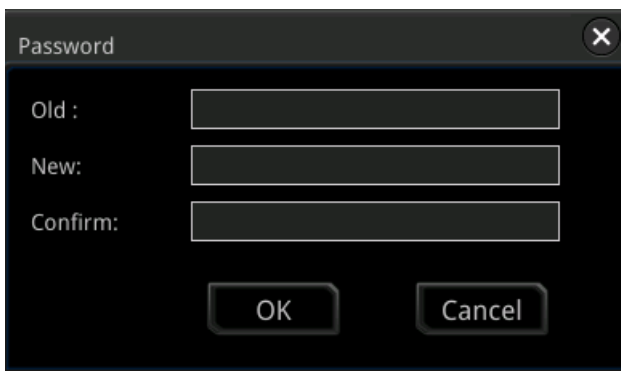

- **ESC**: Press this key to cancel the auto setting and recovers to the parameter settings prior to pressing the **AUTO** key.

**Note:** The waveform auto setting function requires that the frequency of the signal should be greater than or equal to 35 Hz, the amplitude greater than or equal to 5 mV. If not meeting the conditions, the waveform auto setting function may be invalid.

## Measurement Parameter

Press **Measure** on the front panel to enter the measurement setting menu. You can set the measurement source, enable or disable the all measurement function, the statistical analysis function, and etc. You can also quickly make measurements for 41 waveform parameters. The measurement results will be displayed on the screen. The measurement results on the screen are always marked in the same color as the current measurement channel. You can also enable the touch screen to tap the auto measurement label "Measure" at the top of the screen to enter the measurement setting menu.

**Note:** If there is no signal input for the current source or the measurement result is not within the valid range (too large or too small), then the measurement results are invalid, and "\*\*\*\*\*" is displayed on the screen. Please re-input the signal or set the signal.

### Time Parameters

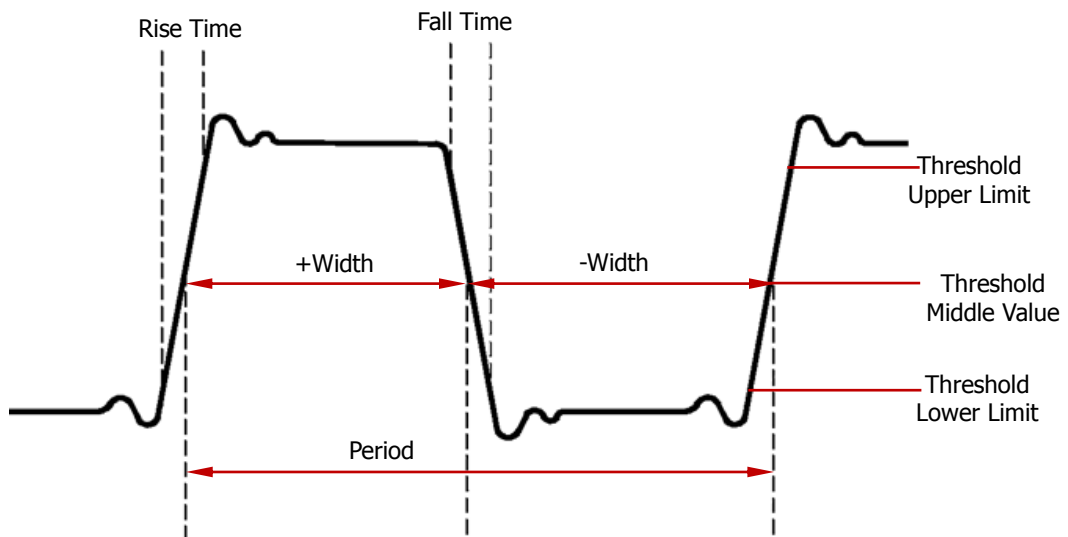

Figure 6-1 Time Parameters

1. **Period:** defined as the time between the middle threshold points of two consecutive, like-polarity edges.
2. **Frequency:** defined as the reciprocal of period.
3. **Rise Time:** indicates the time for the signal amplitude to rise from the threshold lower limit to the threshold upper limit.
4. **Fall Time:** indicates the time for the signal amplitude to rise from the threshold upper limit to the threshold lower limit.
5. **+Width:** indicates the time between the threshold middle value of a rising edge to the threshold middle value of the next falling edge.

6. **-Width:** indicates the time between the threshold middle value of a falling edge to the threshold middle value of the next rising edge.
7. **+Duty:** indicates the ratio of the positive pulse width to the period.
8. **-Duty:** indicates the ratio of the negative pulse width to the period.
9. **Tvmax:** indicates the time that corresponds to the maximum value of the waveform (Vmax).
10. **Tvmin:** indicates the time that corresponds to the minimum value of the waveform (Vmin).

**Note:** The default values for threshold upper limit, threshold middle value, and threshold low limit are 90%, 50%, and 10%, respectively. You can press **Measure** → **Setting** to enter the sub-menu to set the parameters.

## Count Values

1. **Positive Pulse Count:** The number of positive pulses that rise from under the threshold lower limit to above the threshold upper limit.

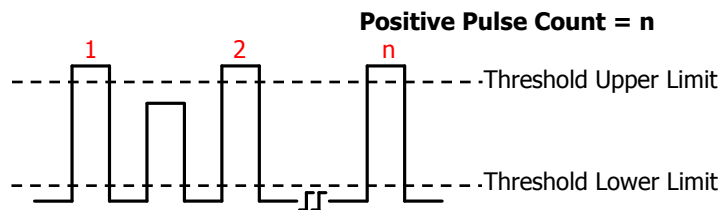

2. **Negative Pulse Count:** The number of negative pulses that fall from above the threshold upper limit to below the threshold lower limit.

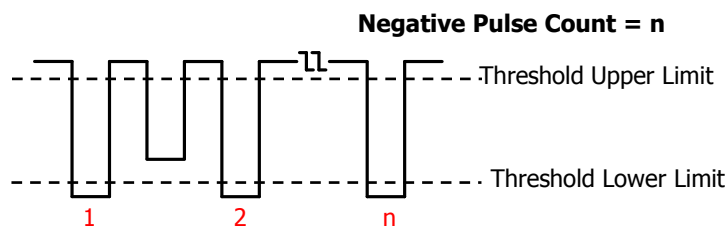

3. **Rising Edge Count:** The number of rising edges that rise from under the threshold lower limit to above the threshold upper limit.

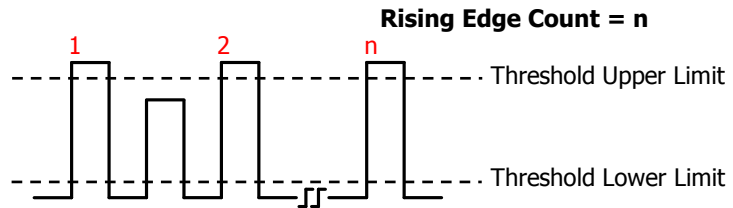

- 4. Falling Edge Count:** The number of falling edges that fall from above the threshold upper limit to below the threshold lower limit.

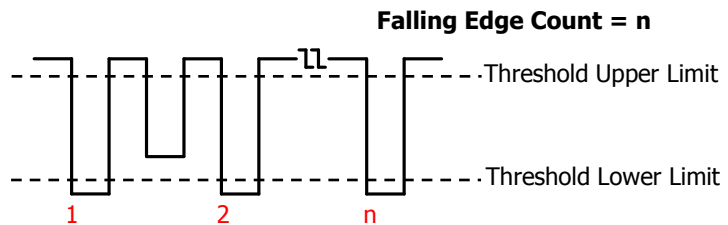

**Note:**

- The above measurement items are only available for the analog channels.
- The default values for threshold upper limit and threshold low limit are 90% and 10%, respectively. You can press **Measure** → **Setting** to enter the sub-menu to set the parameters.

## Delay and Phase

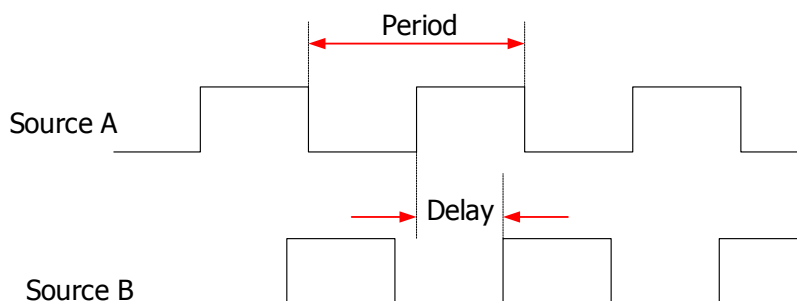

- 1. Delay  $A^f \rightarrow B^f$ :** indicates the time difference between the threshold middle values of the rising edge of Source A and that of Source B. Negative delay indicates that the rising edge of Source A occurred after that of Source B.
- 2. Delay  $A^t \rightarrow B^t$ :** indicates the time difference between the threshold middle values of the falling edge of Source A and that of Source B. Negative delay

indicates that the falling edge of Source A occurred after that of Source B.

3. **Delay  $A_f \rightarrow B_r$** : indicates the time difference between the threshold middle values of the rising edge of Source A and the falling edge of Source B. Negative delay indicates that the rising edge of Source A occurred after the falling edge of Source B.
4. **Delay  $A_r \rightarrow B_f$** : indicates the time difference between the threshold middle values of the falling edge of Source A and the rising edge of Source B. Negative delay indicates that the falling edge of Source A occurred after the rising edge of Source B.
5. **Phase  $A_f \rightarrow B_f$** : indicates the phase deviation between the threshold middle values of the rising edge of Source A and that of Source B. It is expressed in degree. The formula is as follows:

$$Phase_{A_R B_R} = \frac{Delay_{A_R B_R}}{Period_{sourceA}} \times 360^\circ$$

Wherein,  $Phase_{A_R B_R}$  represents Phase  $A_f \rightarrow B_f$ ,  $Delay_{A_R B_R}$  represents Delay  $A_f \rightarrow B_f$ , and  $Period_{sourceA}$  represents period of Source A.

6. **Phase  $A_r \rightarrow B_r$** : indicates the phase deviation between the threshold middle values of the falling edge of Source A and that of Source B. It is expressed in degree. The formula is as follows:

$$Phase_{A_F B_F} = \frac{Delay_{A_F B_F}}{Period_{sourceA}} \times 360^\circ$$

Wherein,  $Phase_{A_F B_F}$  represents Phase  $A_r \rightarrow B_r$ ,  $Delay_{A_F B_F}$  represents Delay  $A_r \rightarrow B_r$ , and  $Period_{sourceA}$  represents period of Source A.

7. **Phase  $A_f \rightarrow B_r$** : indicates the phase deviation between the threshold middle values of the rising edge of Source A and falling edge of Source B. It is expressed in degree. The formula is as follows:

$$Phase_{A_R B_F} = \frac{Delay_{A_R B_F}}{Period_{sourceA}} \times 360^\circ$$

Wherein,  $Phase_{A_R B_F}$  represents Phase  $A_f \rightarrow B_r$ ,  $Delay_{A_R B_F}$  represents Delay  $A_f \rightarrow B_r$ , and  $Period_{sourceA}$  represents period of Source A.

8. **Phase  $A_r \rightarrow B_f$** : indicates the phase deviation between the threshold middle values of the falling edge of Source A and the rising edge of Source B. It is expressed in degree. The formula is as follows:

$$Phase_{A_F B_R} = \frac{Delay_{A_F B_R}}{Period_{sourceA}} \times 360^\circ$$

Wherein,  $Phase_{A_F B_R}$  represents Phase  $A_r \rightarrow B_f$ ,  $Delay_{A_F B_R}$  represents Delay  $A_r \rightarrow B_f$ , and  $Period_{sourceA}$  represents period of Source A.

**Note:**

- Source A and Source B can be any channel among CH1-CH4, Math1-Math4, or D0-D15. You can press **Measure** → **Add** to enter the sub-menu to set the parameters.
- The default threshold middle value is 50%. You can press **Measure** → **Setting** to enter the sub-menu to set the parameters.

**Voltage Parameters**

Figure 6-2 Voltage Parameters

1. **Vmax**: indicates the voltage value from the highest point of the waveform to the GND.
2. **Vmin**: indicates the voltage value from the lowest point of the waveform to the GND.
3. **Vpp**: the voltage value from the highest point to the lowest point of the waveform.
4. **Vtop**: indicates the voltage value from the flat top of the waveform to the GND.
5. **Vbase**: indicates the voltage value from the flat base of the waveform to the GND.
6. **Vamp**: indicates the voltage value from the top of the waveform to the base of the waveform.
7. **Vupper**: indicates the actual voltage value that corresponds to the threshold maximum value.
8. **Vmid**: indicates the actual voltage value that corresponds to the threshold middle value.
9. **Vlower**: indicates the actual voltage value that corresponds to the threshold minimum value.
10. **Vavg**: indicates the arithmetic average value on the whole waveform or in the

gating area. The formula is shown as follows:

$$Average = \frac{\sum_{i=1}^n x_i}{n}$$

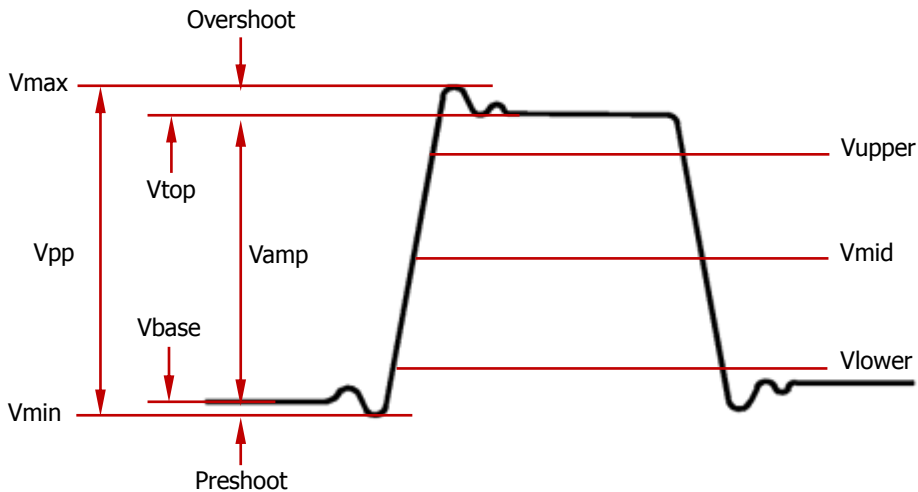
Wherein,  $x_i$  is the measurement result of the  $i$ th point, and  $n$  is the number of points being measured.

- 11. VRMS:** indicates the root mean square value on the whole waveform or in the gating area. The formula is as follows:

$$RMS = \sqrt{\frac{\sum_{i=1}^n x_i^2}{n}}$$

Wherein,  $x_i$  is the measurement result of the  $i$ th point, and  $n$  is the number of points being measured.

- 12. Per.VRMS:** indicates the root mean square value within a period. The formula is as shown above.
- 13. Overshoot:** indicates the ratio of the difference between the maximum value and the top value of the waveform to the amplitude value.
- 14. Preshoot:** indicates the ratio of the difference between the minimum value and the base value of the waveform to the amplitude value.
- 15. Std. Dev:** indicates the root-mean-square value of the waveforms, with the DC component removed. The formula is shown as follows:

$$Std.Dev = \sqrt{\frac{\sum_{i=1}^n (x_i - Average)^2}{n}}$$

Wherein,  $x_i$  is the amplitude of the  $i$ th point,  $Average$  is the waveform average value, and  $n$  is the number of the points being measured.

## Other Parameters

- 1. Positive Slew Rate:** On the rising edge, first calculate the difference between the high value and the low value, then use the difference to divide the corresponding time value to obtain the positive slew rate.
- 2. Negative Slew Rate:** On the falling edge, first calculate the difference between the low value and the high value, then use the difference to divide the corresponding time value to obtain the negative slew rate.
- 3. Area:** indicates the area of the whole waveform within the screen. The unit is V\*s. The area of the waveform above the zero reference (namely the vertical offset) is positive, and the area of the waveform below the zero reference is negative. The area measured is the algebraic sum of the area of the whole waveform within the screen.
- 4. Period Area:** indicates the area of the first period of waveform on the screen. The unit is V\*s. The area of the waveform above the zero reference (namely the vertical offset) is positive, and the area of the waveform below the zero



reference is negative. The area measured is the algebraic sum of the whole period area.

## Measurement Settings

### 1. Measurement Category

Press **Measure** → **Add** → **Category** to select "Horizontal", "Vertical", or "Other". Meanwhile, the specific measurement parameters are displayed on the screen, as shown in the figure below. In the measurement category area, you can also rotate the multifunction knob  to select "Horizontal", "Vertical", or "Other". Then press down the knob to switch to the desired measurement category.

- "Horizontal" measurement parameters: Period, Freq, RiseTime, FallTime, +Width, -Width, +Duty, -Duty, +Pulses, -Pulses, +Edges, -Edges, Tvmax, Tvmin, +SlewRate, and -SlewRate.
- "Vertical" measurement parameters: Vmax, Vmin, Vpp, Vtop, Vbase, Vamp, Vmid, Vlower, Vavg, VRMS, Per.VRMS, Overshot, Preshoot, Area, Per.Area, and Variance.
- "Other" measurement parameters: Delay(A<sup>f</sup> → B<sup>f</sup>), Delay(A<sup>t</sup> → B<sup>t</sup>), Delay(A<sup>f</sup> → B<sup>t</sup>), Delay(A<sup>t</sup> → B<sup>f</sup>), Phase(A<sup>f</sup> → B<sup>f</sup>), Phase(A<sup>t</sup> → B<sup>t</sup>), Phase(A<sup>f</sup> → B<sup>t</sup>), and Phase(A<sup>t</sup> → B<sup>f</sup>).

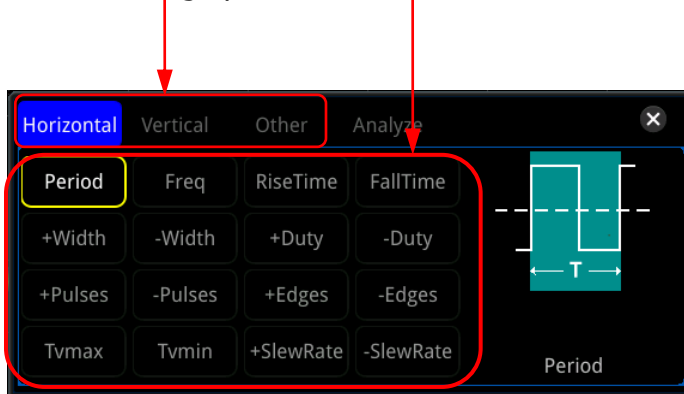

Measurement Category Area    Measurement Parameter Area



In the measurement parameter area, rotate the multifunction knob  to select a measurement item and then press down the knob to select it. Then the measurement results of the item are displayed at the bottom of the screen (measurement results of up to 10 items can be displayed at most). When you add a new measurement item, its measurement result will be displayed as the first, with the original items moving right in sequence. If the number of measurement items added exceeds 10, then when you add one item, the rightmost item at the bottom of the screen will be disabled. You can also enable the touch screen to select the measurement category and the measurement

parameters.

### Tip

- When you rotate the multifunction knob  to switch from the measurement parameter area to the measurement category area, you need to press down the knob  to select the desired measurement category.
- In the measurement category area, rotate the multifunction knob  to select "Analyze". The following figure is displayed. Select "Counter", "DVM", or "Power" (available when the power analysis option is installed) to enter the corresponding function setting menu. For descriptions about these functions, refer to relevant chapters.

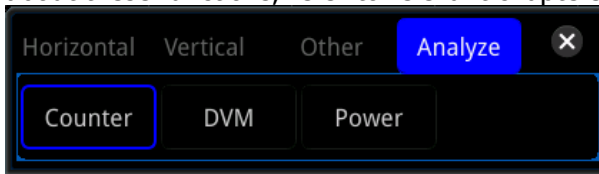

## 2. Source Selection

For different measurement categories, the selection methods for measurement sources are different.

### ● Horizontal and vertical parameter measurement

Press **Measure** → **Add** → **Source A**, rotate the multifunction knob  to select the desired channel for measurement and press down the knob to select it. You can also press **Source A** continuously or enable the touch screen to select the current measurement source. The available channels include CH1-CH4, Math1-Math4, and D0-D15.

### ● Other (Delay and Phase) parameter measurement

Press **Measure** → **Add** → **Source A (Source B)** to set the two source channels for the current measurement category. The available channels include CH1-CH4, Math1-Math4, and D0-D15.

**Note:** When **Source A** is set to an analog channel (or a digital channel), **Source B** can also be set to an analog channel (or a digital channel).



## 3. Indicator

Press **Indicator** to enable or disable the indicator. You can also press **Measure** → **Remove** → **Indicator** to enable or disable the indicator. For details, refer to descriptions in "**Measure Mode**".

## 4. Measurement Settings

Press **Measure** → **Setting** to enter the sub-menu of measurement.

- Press **Mode** to select the measurement mode to "Normal" or "Precision".

- Normal: executes measurement of up to 1 Mpts.
- Precision: executes measurement of up to 500 Mpts, improving the resolution of measurement results. Note, in this mode, the refresh rate of the waveforms may be reduced.
- Press **Type** to select "Threshold", "Range", or "Amp Method".
  - Select "Threshold", and then make the following settings:
    - Press **Source** to select the desired channel for measurement (CH1-CH4 or Math1-Math4).
    - Press **Upper** to select "Upper(%)" or "Upper(Abs)" first, and then press the key to set the upper limit of the measurement. For details, refer to descriptions in "**Parameter Setting Method**". Reducing the upper limit to the current middle value will automatically reduce the middle value and lower limit to keep them lower than the upper limit. By default, it is 90%.
    - Press **Mid** to select "Mid(%)" or "Mid(Abs)" first, and then press the key to set the middle value of the measurement. For details, refer to descriptions in "**Parameter Setting Method**". The middle value is limited by the settings of the upper limit and lower limit. By default, it is 50%.
    - Press **Lower** to select "Lower(%)" or "Lower(Abs)" first, and then press the key to set the lower limit of the measurement. For details, refer to descriptions in "**Parameter Setting Method**". Increasing the lower limit to the current middle value will automatically increase the middle value and upper limit to keep them higher than the lower limit. By default, it is 10%.
    - Press **Default**, and then the upper value, middle value, and lower value will be restored to the defaults.
  - Select "Range", and then press **Region** to select "Main", "Zoom", or "Cursor".
    - Main: indicates that the measurement range is within the main time base region.
    - Zoom: indicates that the measurement range is within the zoomed time base region. Note: Only when you enable the delayed sweep function first, can "Zoom" be enabled.
    - Cursor: when you select it, two cursors will be displayed on the screen. At this time, press **CursorA** and **CursorB** respectively and then rotate the multifunction knob  to adjust the positions of the two cursors to determine the measurement range. Also, you can press **CursorAB** and then rotate the multifunction knob  to adjust the positions of the two cursors simultaneously.
  - Select "Amp Method", and then press **Amp Method** to select "Auto" or "Manual". This method affects the measurement method for the top and base values. If you select "Manual", you need to set the following parameters:
    - Press **Top** to select "Histogram" or "Max-Min".
    - Press **Base** to select "Histogram" or "Max-Min".

**Tip**

- Modifying the threshold will affect the measurement results of the time, delay and phase parameters.
- If you select "Manual" under **Amp Method**, the measurement results of other parameters may be affected.
- "Histogram" and "Max-Min" are the internal measurement algorithm for the oscilloscope. The "Histogram" method here is different from the Histogram function of the oscilloscope.

## Remove the Measurement Result

This oscilloscope allows you to remove the measurement results of the parameters. Press **Measure** → **Remove** to enter the "Remove" sub-menu.

- Press **Remove** to remove the last added measurement item. Note that pressing this key one time can only remove one measurement item. When you remove a measurement item, the measurement result of the last added item at the bottom of the screen will be removed. You can rotate the multifunction knob  to switch the measurement item, then press down the knob or press **Remove** to remove the item. You can also enable the touch screen to tap the desired measurement item, and then press **Remove** to remove the item.
- Press **Remove All** to remove all the displayed measurement items.
- Press **Indicator** to enable or disable the indicator.

Besides, you can also press **Measure** → **Add** → **Remove** to enter the "Remove" sub-menu.

**Tip**

If the "Remove" sub-menu is not displayed in the current menu, when you select a certain measurement item, the system will automatically enter the "Remove" sub-menu.

## Statistical Function

Performs statistics and displays the measurement results (Cur, Avg, Max, Min, Dev, and Cnt) of at most 10 items, as shown in the figure below.

	Vmax1	Vpp1
Cur:	453.6mV	1.436V
Avg:	384.9mV	1.405V
Max:	453.6mV	1.436V
Min:	378.0mV	1.361V
Dev:	21.73mV	37.21mV
Cnt:	22	85

Press **Measure** → **Statistic** to enter the sub-menu of "Statistic".

- Press **Statistic** to enable or disable the statistical function.
- Press **Reset Stat.** to clear the history statistics data and makes statistics again.
- Press **Count**, then rotate the multifunction knob  or use the pop-up numeric keypad to set the count value. Its range is from 2 to 5000. By default, it is 1000.

## All Measurement

All measurement could measure the time parameter, count value, voltage parameters, and other parameters of the current measurement source and display the results on the screen. Press **Measure** → **All Measure** to select "OFF" (disabling the all measurement function) or select the desired channel for measurement (CH1-CH4). If you select "CH1", data of all measurement parameters of CH1 are displayed on the screen.

**Note:** The removal operation will not clear the measurement results of the all-measurement function.

## Cursor Measurement

Cursor measurement can measure the X-axis values (e.g Time) and Y-axis values (e.g. Voltage) of the selected waveform. Before making cursor measurement, connect the signal to the oscilloscope to acquire stable display. All the parameters supported by the "**Auto Measurement**" function can be measured with cursor measurement. The cursor measurement function provides the following two cursors.

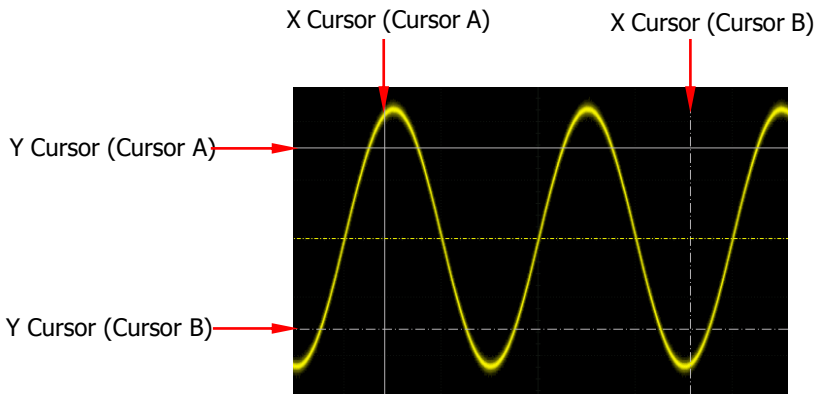

- **X Cursor**

X cursor is a vertical solid/dotted line that is used to make horizontal adjustments. It can be used to measure time (s), frequency (Hz), phase ( $^{\circ}$ ), and ratio (%).

- Cursor A is a vertical solid line ( $\text{AX}$  is displayed at the bottom of the screen), and Cursor B is a vertical dotted line ( $\text{BX}$  is displayed at the bottom of the screen).
- In the X-Y cursor mode, X cursor is used to measure the waveform amplitude of CH1.

- **Y Cursor**

Y cursor is a horizontal solid/dotted line that is used to make vertical adjustment. It can be used to measure amplitude (the unit is the same as that of the source channel amplitude) and ratio (%).

- Cursor A is a horizontal solid line, ( $\text{AY}$  is displayed at the right section of the screen), and Cursor B is a horizontal dotted line ( $\text{BY}$  is displayed at the right section of the screen).
- In the X-Y cursor mode, Y cursor is used to measure the waveform amplitude of CH2.

Press **Cursor** on the front panel to open the cursor measurement menu, or enable the touch screen and then tap the function navigation icon  $\text{FN}$  at the lower-left corner of the screen to open the function navigation. Then, tap the "Cursor" icon to open the cursor measurement menu.

In the cursor measurement menu, press **Mode** and then rotate the multifunction knob  $\text{M}$  to select the desired cursor mode (the default is "OFF"). Press down the knob to select it. You can also press the **Mode** key continuously or enable the touch screen to select the desired mode. The available modes are "Manual", "Track", "XY", and "Measure". When you select "OFF", the cursor measurement function is disabled.

**Note:** When the Time Base Mode is set to "XY", the XY cursor measurement mode is valid.

## Manual Mode

In this mode, you can adjust the cursor manually to measure the value of the waveforms of the specified source at the current cursor. The measurement results are displayed at the upper-left corner of the screen. When you change the cursor position, the measurement results will be changed accordingly.

Press **Mode** to select "Manual" to enable the manual cursor measurement function. If the settings for the parameter such as "Select", "Source", "Hori. Unit", and "Vert. Unit" are different, the measurement results will be different for cursor measurement. The measurement results are displayed at the upper-left corner of the screen, as shown in the figure below.

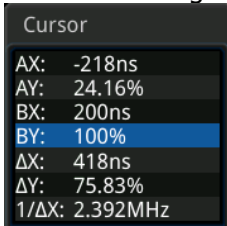

- AX: indicates the X value at Cursor A.
- AY: indicates the Y value at Cursor A.
- BX: indicates the X value at Cursor B.
- BY: indicates the Y value at Cursor B.
- ΔX: indicates the horizontal spacing between Cursor A and Cursor B.
- ΔY: indicates the vertical spacing between Cursor A and Cursor B.
- 1/ΔX: indicates the reciprocal of the horizontal spacing between Cursor A and Cursor B.

### 1. Select Cursor Type

Press **Select** continuously to select the cursor type.

- X: It is a pair of vertical solid (Cursor A)/dotted (Cursor B) lines, used for measuring time parameters. The measurement results include AX, BX, ΔX, and 1/ΔX (displayed only when "s" or "Hz" is selected under **Hori. Unit**).
- Y: It is a pair of horizontal solid (Cursor A)/dotted (Cursor B) lines, used for measuring voltage parameters. The measurement results include AY, BY, and ΔY.

### 2. Select Measurement Source







Press **Source**, then rotate the multifunction knob  to select the desired source (CH1-CH4). Press down the knob to select it. You can also press **Source** continuously or enable the touch screen to select it. The available source

channels are None, CH1-CH4, LA, and Math1-Math4.

**Note:**

- Only channels currently enabled can be selected.
- When "LA" is selected under **Source**, **Select** is grayed out and disabled. By default, "X" is selected under **Select**.

### 3. Adjust Cursor Position

- 1) When "X" is selected under **Select**, you can adjust the position of X cursor.
  - Press **AX**, then rotate the multifunction knob  to adjust the horizontal position of Cursor A (X cursor). Its adjustable range is limited within the screen.
  - Press **BX**, then rotate the multifunction knob  to adjust the horizontal position of Cursor B (X cursor). Its adjustable range is limited within the screen.
  - Press **AX BX**, then rotate the multifunction knob  to adjust the horizontal position of Cursor A and Cursor B (X cursors) simultaneously. Its adjustable range is limited within the screen. The horizontal spacing between Cursor A and Cursor B (X cursors) remains unchanged.
- 2) When "Y" is selected under **Select**, you can adjust the position of Y cursor.
  - Press **AY**, then rotate the multifunction knob  to adjust the vertical position of Cursor A (Y cursor).
  - Press **BY**, then rotate the multifunction knob  to adjust the vertical position of Cursor B (Y cursor).
  - Press **AY BY**, then rotate the multifunction knob  to adjust the vertical position of Cursor A and Cursor B (Y cursors) simultaneously. The vertical spacing between Cursor A and Cursor B (Y cursors) remains unchanged.

**Note:** If one of the three items (**AX**, **BX**, and **AX BX**) or one of the three items (**AY**, **BY**, and **AY BY**) is selected, you can press down the multifunction knob  continuously to switch among the three items.

### 4. Select Screen Region

- When the delayed sweep function is disabled, press **More**, and "Main" is automatically selected under **Region** and cannot be modified.
- When the delayed sweep function is enabled, the screen is divided into two regions: main time base and zoomed time base. Press **Region** continuously to select "Main" or "Zoom".
  - When "Main" is selected, the cursor is displayed in the main time base region, and you can measure the parameters in the main time base region.
  - When "Zoom" is selected, the cursor is displayed in the zoomed time base region, and you can measure the parameters in the zoomed time base region.



## 5. Set the Horizontal/Vertical Measurement Unit

- When "X" is selected under **Select**, you can set the horizontal measurement unit. When the source can be Math1-Math4, this menu is grayed out and disabled.

Press **More** → **Hori. Unit**, and rotate the multifunction knob  to select the horizontal measurement unit. Then press down the knob to select it. You can also press **Hori. Unit** continuously or enable the touch screen to select it. The available units include "s", "Hz", "Degree(°)", and "Percent(%)".

- s: measures the time value at X Cursor (taking the trigger position as reference). The measurement results include AX, BX,  $\Delta X$ , and  $1/\Delta X$ . Wherein, AX, BX, and  $\Delta X$  all indicate time, and  $1/\Delta X$  indicates frequency.
  - Hz: measures the frequency value at X Cursor (taking the trigger position as reference). The measurement results include AX, BX,  $\Delta X$ , and  $1/\Delta X$ . Wherein, AX, BX, and  $\Delta X$  all indicate frequency, and  $1/\Delta X$  indicates time.
  - Degree(°): measures the phase value at X Cursor. The measurement results include AX, BX, and  $\Delta X$ , and they are all expressed in degree. This oscilloscope allows you to set the reference position for the phase according to your needs. After adjusting X Cursor to a desired position, press **Set Reference** to take the current cursor position as the reference. The current positions of Cursor A and Cursor B are respectively defined as "0°" and "360°". Meanwhile, two vertical cursors (in blue) that cannot be moved are displayed on the screen as the phase reference position (the phase position at "0°" and "360°" are respectively marked by a solid line and a dotted line). Before you set manually, the oscilloscope adopts the default phase reference position.
  - Percent(%): measures ratio at X Cursor. The measurement results include AX, BX, and  $\Delta X$ , and they are all expressed in percentage. This oscilloscope allows you to set the reference position for the ratio according to your needs. After adjusting X Cursor to a desired position, press **Set Reference** to take the current cursor position as the reference. The current positions of Cursor A and Cursor B are respectively defined as "0%" and "100%". Meanwhile, two cursors (in blue) that cannot be moved are displayed on the screen as the ratio reference position (the ratio position at "0%" and "100%" are respectively marked by a solid line and a dotted line). Before you set manually, the oscilloscope adopts the default ratio reference position.
- When "Y" is selected under **Select**, you can set the vertical measurement unit. When the source can be Math1-Math4, this menu is grayed out and disabled.

Press **More** → **Vert. Unit**, and rotate the multifunction knob  to select the vertical measurement unit. Then press down the knob to select it. You can also press **Vert. Unit** continuously or enable the touch screen to select it.

The available units include "Source" and "Percent(%)".

- Source: measures the amplitude at Y Cursor (taking the channel ground point as the reference). The measurement results include AY, BY, and  $\Delta Y$  (its unit is consistent with that of the current source).
- Percent(%): measures ratio at Y Cursor. The measurement results include AY, BY, and  $\Delta Y$ , and they are all expressed in percentage. This oscilloscope allows you to set the reference position for the ratio according to your needs. After adjusting Y Cursor to a desired position, press **Set Reference** to take the current cursor position as the reference. The current positions of Cursor A and Cursor B are respectively defined as "0%" and "100%". Meanwhile, two cursors (in blue) that cannot be moved are displayed on the screen as the ratio reference position (the ratio position at "0%" and "100%" are respectively marked by a solid line and a dotted line). Before you set manually, the oscilloscope adopts the default ratio reference position.

### 6. Set LA Type

When "LA" is selected under **Source**, you need to set the LA display type. Press **More** and then press **La Type** continuously to select "HEX" or "BIN".

### 7. Measurement Example

Measure the period of a sine wave by using the manual cursor measurement and auto measurement respectively. The measurement results are both 1 ms, as shown in Figure 6-3.

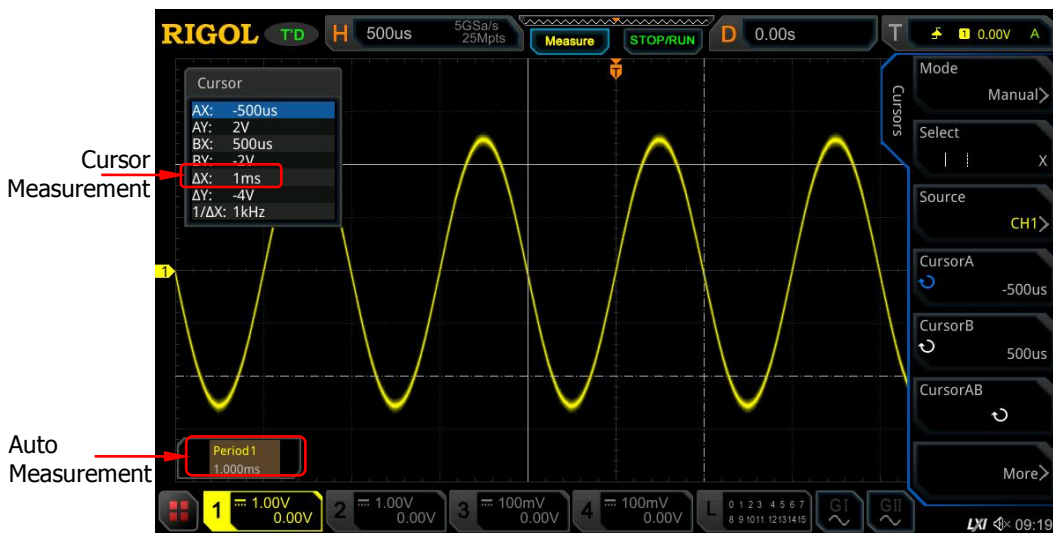



Figure 6-3 Manual Cursor Measurement Example

## Track Mode

In this mode, you can adjust the two pairs of cursors (Cursor A and Cursor B) to measure the X and Y values on two different sources respectively. The points being measured on Cursor A and Cursor B are marked by  and  respectively. When the cursors are moved horizontally/vertically, the markers will position on the waveform automatically. When the waveform is expanded or compressed horizontally/vertically, the markers will track the points being marked at the last adjustment of the cursors.

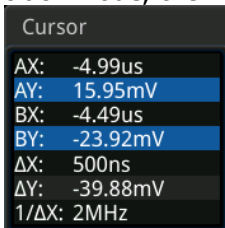

**Note:** When the delayed sweep function is enabled, the track cursor is within the expanded area.

Press **Mode** to select "Track" to enable the cursor track function, and the measurement results will be displayed at the upper-left corner of the screen, as shown in the following figure. When you change the measurement parameter for the track mode, the measurement results will be changed accordingly.



- AX: indicates the X value at Cursor A.
- AY: indicates the Y value at Cursor A.
- BX: indicates the X value at Cursor B.
- BY: indicates the Y value at Cursor B.
- ΔX: indicates the horizontal spacing between Cursor A and Cursor B.
- ΔY: indicates the vertical spacing between Cursor A and Cursor B.
- 1/ΔX: indicates the reciprocal of the horizontal spacing between Cursor A and Cursor B.

### 1. Select Measurement Source

- Press **AX Source**, then rotate the multifunction knob  to select the desired measurement source. Press down the knob to select it. You can also press **AX Source** continuously or enable the touch screen to select it. The available source channels are None, CH1-CH4, and Math1-Math4.
- Press **BX Source**, then rotate the multifunction knob  to select the desired source (CH1-CH4). Press down the knob to select it. You can also press **BX Source** continuously or enable the touch screen to select it. The available source channels are None, CH1-CH4, and Math1-Math4.







**Note:** Only channels currently enabled can be selected.

### 2. Select the Track Axis

Press **Track** to select "X" or "Y" as the current track axis. The default is "X".

- X: tracks X Cursor and measures the value at X Cursor.
- Y: tracks Y Cursor and measures the time of the first point at the left side of the screen.

### 3. Adjust Cursor Position

- 1) When "X" is selected under **Select**, you can adjust the position of X cursor.
  - Press **AX**, then rotate the multifunction knob  to adjust the horizontal position of Cursor A (X cursor). Its adjustable range is limited within the screen.
  - Press **BX**, then rotate the multifunction knob  to adjust the horizontal position of Cursor B (X cursor). Its adjustable range is limited within the screen.
  - Press **AX BX**, then rotate the multifunction knob  to adjust the horizontal position of Cursor A and Cursor B (X cursors) simultaneously. Its adjustable range is limited within the screen. The horizontal spacing between Cursor A and Cursor B (X cursors) remains unchanged.
- 2) When "Y" is selected under **Select**, you can adjust the position of Y cursor.
  - Press **AY**, then rotate the multifunction knob  to adjust the vertical position of Cursor A (Y cursor).
  - Press **BY**, then rotate the multifunction knob  to adjust the vertical position of Cursor B (Y cursor).
  - Press **AY BY**, then rotate the multifunction knob  to adjust the vertical position of Cursor A and Cursor B (Y cursors) simultaneously. The vertical spacing between Cursor A and Cursor B (Y cursors) remains unchanged.

#### Note:

- If one of the three items (**AX**, **BX**, and **AX BX**) or one of the three items (**AY**, **BY**, and **AY BY**) is selected, you can press down the multifunction knob  continuously to switch among the three items.
- In track mode, the horizontal cursor (or vertical cursor) will track the marked point in a timely manner (i.g, the cursor will move up and down with the transient change of the waveform). Thus, the X value (or Y value) might change even though you do not adjust the cursor.

### 4. Measurement Example

Measure the waveforms of CH1 and CH2 with Cursor A and Cursor B, respectively. Then, expand the waveforms horizontally, and you will find that the cursor will track the point that has been marked, as shown in the following figure.

**Track Measurement (before Horizontal Expansion):****Track Measurement (after Horizontal Expansion):****XY Mode**

XY mode is only available when the horizontal time base mode is "XY" (refer to **"Timebase Mode"**). In this mode, two pairs of cursors will appear. You can adjust the cursor positions to measure the X and Y values at the crossing points of the two pairs of cursors.



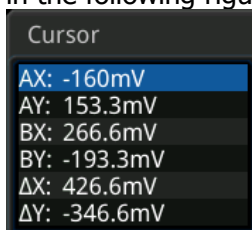



Press **Mode** to select "XY" to enable the XY cursor measurement function. The measurement results are displayed at the upper-left corner of the screen, as shown in the following figure.





- AX: indicates the X value at Cursor A.
- AY: indicates the Y value at Cursor A.
- BX: indicates the X value at Cursor B.
- BY: indicates the Y value at Cursor B.

- $\Delta X$ : indicates the horizontal spacing between Cursor A and Cursor B.
- $\Delta Y$ : indicates the vertical spacing between Cursor A and Cursor B.

### 1. Adjust Cursor Position

- Press **AX** and rotate the multifunction knob  to adjust the X value at Cursor A.
- Press **BX** and rotate the multifunction knob  to adjust the X value at Cursor B.
- Press **AY** and rotate the multifunction knob  to adjust the Y value at Cursor A.
- Press **BY** and rotate the multifunction knob  to adjust the Y value at Cursor B.
- Press **More**  $\rightarrow$  **ABX** and rotate the multifunction knob  to adjust the X value at Cursor A and the X value at Cursor B simultaneously.
- Press **More**  $\rightarrow$  **ABY** and rotate the multifunction knob  to adjust the Y value at Cursor A and the Y value at Cursor B simultaneously.

During the adjustment, the measurement results will change accordingly. The adjustable range is limited within the screen.

**Note:** If one of the four items (**AX**, **BX**, **AY**, and **BY**) is selected, you can press down the multifunction knob  continuously to switch among the four items. If you select either of the items (**ABX** and **ABY**), you can press down the multifunction knob  continuously to switch between them.

### 2. Display Lissajous Legend

This oscilloscope provides the Lissajous schematic diagram under different frequencies and phase deviation, as shown in Figure 6-4. Press **More**  $\rightarrow$  **Lissajous**, then the Lissajous schematic diagram is displayed.

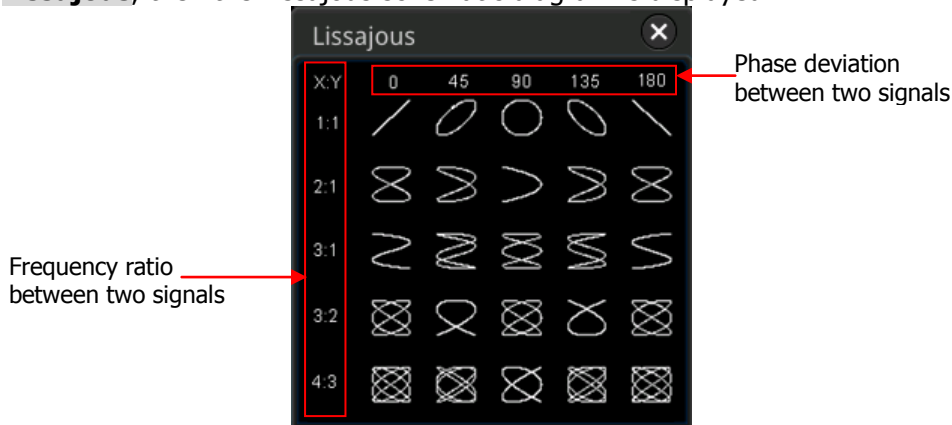

Figure 6-4 Lissajous Schematic Diagram

## Measure Mode

Press **Mode** to select "Measure". In this mode, the cursor position for measurement is displayed.

Press **Indicator** continuously to enable or disable the indicator. If it is enabled, one or multiple cursors are displayed on the screen. Before enabling the indicator, you need to enable at least one parameter for auto measurement. The number of cursors will change along with the enabled measurement parameters.

**Note:** If no measurement parameter is selected or no measurement source is input, no cursor is displayed. When you expand or compress the waveforms horizontally, the cursor will change accordingly.◦





## Chapter 7 Digital Voltmeter (DVM) and Frequency Counter



MSO5000 series oscilloscope provides a built-in digital voltmeter (DVM) and frequency counter, which enable you to perform an accurate measurement, improving user experience in counter and frequency measurement.

Contents in this chapter:

- Digital Voltmeter (DVM)
- Frequency Counter

## Digital Voltmeter (DVM)

The built-in DVM of this oscilloscope provides 3-digit voltage measurements on any analog channel. DVM measurements are asynchronous from the oscilloscope's acquisition system and are always acquiring.

Press **Measure** → **Analyze** → **DVM** to open the DVM setting menu, or enable the touch screen and then tap the function navigation icon  at the lower-left corner of the screen to open the function navigation. Then, tap the "DVM" icon to open the DVM setting menu. You can also press **Measure** → **Add**, then in the displayed measurement category area, rotate the multifunction knob  to select "Analyze", and then select "DVM" to open the DVM setting menu.

### To Enable or Disable DVM Measurement

In the "DVM" setting menu, press **DVM** continuously to enable or disable DVM measurement. When enabled, the following figure is displayed. The DVM display also has a scale that is determined by the channel's vertical scale and vertical offset. The scale range is the range of the screen. The scale's yellow triangle pointer shows the most recent measurement result. The specific value above the pointer shows the measurement extrema over the last 3 seconds.

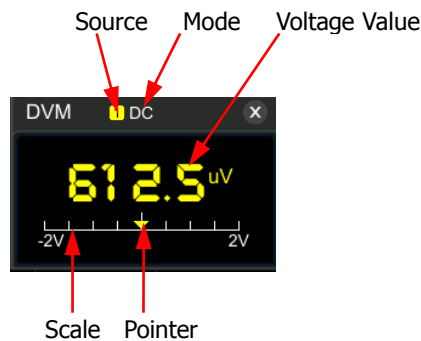

**Note:** DVM measurement and the oscilloscope share the same probe, so the unit for the DVM measurement is consistent with that of the channel.

### To Select the Measurement Source

Press **Source** in the "DVM" setting menu, then rotate the multifunction knob  to select the desired source. Press down the knob to select it. You can also press **Source** continuously or enable the touch screen to select it. The analog channel (CH1-CH4) can be selected to be the measurement source.

**Note:** Even if the analog channel (CH1-CH4) is not enabled, you can still perform the DVM measurement.



## To Select Measurement Mode

Press **Mode** in the "DVM" setting menu, then rotate the multifunction knob  to select the desired mode, and then press down the knob to select the mode. You can also press **Mode** continuously to select the mode or enable the touch screen to tap the desired mode and select it. The DVM measurement modes include AC RMS, DC, and AC+DC RMS.

- AC RMS: displays the root-mean-square value of the acquired data, with the DC component removed.
- DC: displays the average value of the acquired data.
- AC+DC RMS: displays the root-mean-square value of the acquired data.



## To Set the Limits

Press **Limits** to enter the sub-menu of Limits. Then set the following parameters.

- **Beeper**  
Press **Beeper** continuously to enable or disable the beeper.
- **Limits Condition Setting**  
Press **When**, then rotate the multifunction knob  to select the desired limit setting condition. Press down the knob to select it. You can also press **When** continuously or enable the touch screen to select it. The limits conditions include "In Limits" and "Out Limits".
  - In Limits: when the voltage value is within the limits, you can enable or disable the beeper to sound an alarm.
  - Out Limits: when the voltage value is outside of the limits, you can enable or disable the beeper to sound an alarm.
- **Upper/Lower Limit Setting**  
Press **Upper**, then rotate the multifunction knob  or use the pop-up numeric keypad to set the upper limit of the voltage.  
Press **Lower**, then rotate the multifunction knob  or use the pop-up numeric keypad to set the lower limit of the voltage.

## Frequency Counter

The frequency counter analysis function provides frequency, period, or edge event counter measurements on any analog channel.

Press **Measure** → **Analyze** → **Counter** to open the frequency counter setting menu, or enable the touch screen and then tap the function navigation icon  at the lower-left corner of the screen to open the function navigation. Then, tap the "Counter" icon to open the frequency counter setting menu. You can also press **Measure** → **Add**, then in the displayed measurement category area, rotate the multifunction knob  to select "Analyze", and then select "Counter" to open the frequency counter setting menu.

### To Enable or Disable the Frequency Counter

In the "Counter" setting menu, press **Counter** continuously to enable or disable the frequency counter measurement. When enabled, the following figure is displayed.

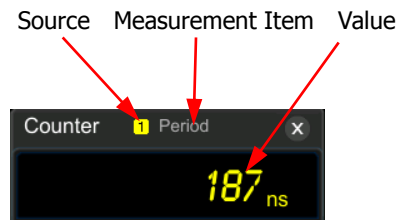

### To Select the Measurement Source

Press **Source**, then rotate the multifunction knob  to select the desired source, and then press down the knob to select the source. You can also press **Source** continuously or enable the touch screen to select it. The analog channels (CH1-CH4) and digital channels (D0-D15) can all be selected as the source of the frequency counter.

### To Select the Measurement Item

The measurement items supported by the frequency counter of this oscilloscope include Frequency, Period, and Totalize measurements. Wherein, Totalize indicates the count of edge events on the signal.

Press **Measure** in the "Counter" menu, then rotate the multifunction knob  to select the desired measurement item, and then press down the knob to select the

item. You can also press **Measure** continuously or enable the touch screen to tap the desired measurement item and select it.

## To Set Resolution

For Period and Frequency measurements, you need to set the readout resolution. Press **Resolution**, then rotate the multifunction knob  or use the pop-up numeric keypad to set the resolution. The range of resolution is from 3 bits to 6 bits. By default, it is 5 bits.

**Note:** The greater the resolution, the longer the gate time. In this way, the measurement time will be longer.

## To Clear Count

When "Totalize" is selected under **Measure**, the oscilloscope measures the count of edge events on the signal. At this time, press **Clear Count** to clear the measurement results.

## To Enable or Disable the Statistical Function

For Period and Frequency measurements, enable the frequency counter statistical function. Press **Statistic** continuously to enable or disable the statistical function. When enabled, the maximum value and minimum value will be displayed in the frequency counter data, as shown in the following figure.

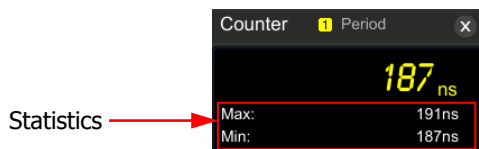



## Chapter 8 Power Analysis (Option)

MSO5000 series oscilloscope provides an optional power analysis function, which can help you easily analyze the efficiency and reliability of the switch-mode power supplies. With the power analysis function, you can analyze the power quality and output ripple noise of the input power.

Contents in this chapter:

- Power Quality
- Ripple

## Power Quality

By analyzing the power quality, you can test the quality of AC input lines. The specific measurement parameters for power quality analysis include  $V_{RMS}$ ,  $I_{RMS}$ , real power, apparent power, reactive power, power factor, reference frequency, phase angle, impedance, voltage crest factor, and current crest factor.



Press **Measure** → **Analyze** → **Power Analyzer** to open the power analysis setting menu, or enable the touch screen and then tap the function navigation icon  at the lower-left corner of the screen to open the function navigation. Then, tap the "Power" icon to open the power analysis setting menu.

- **Select the Analysis Type**

In the power analysis setting menu, press **Analysis Type** and rotate the multifunction knob  to select "Power Quality", and then press down the knob to select it. You can also press **Analysis Type** continuously or enable the touch screen to select the desired analysis type.



- **Set the Power Quality Analysis Source**

In the power analysis setting menu, press **Source** to enter the source setting menu.

- Press **Voltage** and then rotate the multifunction knob  to select the channel (CH1-CH4) for acquiring voltage. Press down the knob to select it. You can also press **Voltage** continuously or enable the touch screen to select the channel.
- Press **Current** and then rotate the multifunction knob  to select the channel (CH1-CH4) for acquiring current. Press down the knob to select it. You can also press **Current** continuously or enable the touch screen to select the channel.
- Press **Freq. Ref** continuously to select "Voltage" or "Current" as the frequency reference.

- **Set the Reference Level**

In the power analysis setting menu, press **Ref Levels** (level of the frequency reference channel) to enter the reference level setting menu.

- Press **Type**, and rotate the multifunction knob  to set the reference level display type to "Percent(%)" or "Absolute", and then press down the knob to select it. You can also press **Type** continuously or enable the touch screen to select the type.
- Press **Upper**, then rotate the multifunction knob  or use the pop-up numeric keypad to set the upper limit value. Reducing the upper limit to the current middle value will automatically reduce the middle value and lower limit to keep them lower than the upper limit.
- Press **Mid**, then rotate the multifunction knob  or use the pop-up numeric keypad to set the middle value. The middle value is limited by the



settings of the upper limit and lower limit.

- Press **Lower**, then rotate the multifunction knob  or use the pop-up numeric keypad to set the lower limit. Increasing the lower limit to the current middle value will automatically increase the middle value and upper limit to keep them higher than the lower limit.
- Press **Default**, and then the upper value, middle value, and lower value will be restored to the defaults.

- **Set Count**

Press **Count**, then rotate the multifunction knob  or use the pop-up numeric keypad to set the number of statistical times for power quality analysis. Its range is from 2 to 5000. By default, it is 1,000.

- **Reset**

Press **Reset Stat.** to clear the current data and execute statistics on the measurement results again.

- **Open or Close the Results Display Window**

Press **Display** continuously to enable or disable the display of the results. When enabled, the statistical results will be displayed on the screen, as shown in the figure below. You can also enable the touch screen to tap the icon  at the right-upper corner of the statistical results window to close it.

**Note:** If you select "ON" under **Display**, the multiplication operation will be enabled in the Math operation.



	Curr	Avg	Max	Min	Dev	Cnt
V_RMS(1)	2.607V	1.794V	2.688V	0.000V	572.4mV	1000
I_RMS(2)	2.561A	1.713A	2.625A	0.000A	563.2mA	1000
Real Power(1)	-3.558W	-1.598W	2.166W	-3.586W	694.8mW	1000
Apparent Power(1-2)	6.679VA	3.394VA	7.052VA	0.000VA	1.514VA	1000
Reactive Power(1-2)	5.652VAR	6.029VAR	6.869VAR	3.323VAR	840.9mVAR	135
Power Factor(1-2)	-532.8m	-320.4m	436.4m	-536.0m	218.7m	135
Frequency(1)	20.00kHz	20.00kHz	20.16kHz	19.97kHz	21.16Hz	137
Phase Angle(1-2)	2.132°	1.903°	2.136°	1.119°	231.6m°	135
Impedance(1-2)	1.017Ω	1.004Ω	1.025Ω	720.1mΩ	61.68mΩ	135
V Crest Factor(1)	1.112	1.147	1.457	1.077	96.94m	135
I Crest Factor(2)	1.114	1.130	1.461	1.098	72.76m	135

- **View the Connection Diagram**

Press **Tips**, and then the connection diagram of the power quality analysis is displayed on the screen. Please connect the cables according to the connection method as shown in Figure 8-1. Press **Tips** again or enable the touch screen to tap the icon  at the right-upper corner of the connection diagram window to close it.

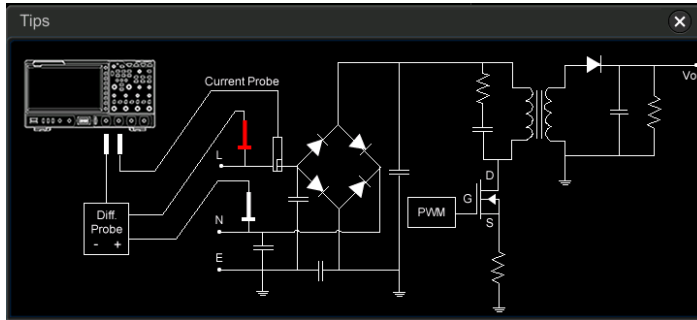



Figure 8-1 Connection Diagram of Power Quality Analysis

## Ripple

Power ripple is an important parameter for evaluating DC power supply, which indicates the ripple quantity of the output DC voltage. The ripple analysis can measure the current value, average value, minimum value, maximum value, standard deviation, and count value of the ripples on the power output terminal.

**Note:** The 1X probe is recommended for the ripple measurement, for example PVP2350.

- **Select the Analysis Type**

In the power analysis setting menu, press **Analysis Type**, and rotate the multifunction knob  to select "Ripple", and then press down the knob to select it. You can also press **Analysis Type** continuously or enable the touch screen to select the desired analysis type.

- **Set the Ripple Analysis Source**

In the power analysis setting menu, press **Source**, and rotate the multifunction knob  to select the ripple analysis source (CH1-CH4), then press down the knob to select the source. You can also press **Source** continuously or enable the touch screen to select it.

- **Set Count**

Press **Count**, then rotate the multifunction knob  or use the pop-up numeric keypad to set the number of statistical times for ripple analysis. Its range is from 2 to 5000. By default, it is 1,000.

- **Reset**

Press **Reset Stat.** to clear the current data and execute statistics on the measurement results again.

- **Open or Close the Results Display Window**

Press **Display** continuously to enable or disable the display of the results. When enabled, the statistical results will be displayed on the screen, as shown in

the figure below. You can also enable the touch screen to tap the icon  at the right-upper corner of the statistical results window to close it.

Ripple(1) 						
	Curr	Avg	Min	Max	Dev	Cnt
Ripple	22.71mV	22.83mV	18.92mV	30.28mV	2.100mV	123

- **View the Connection Diagram**

Press **Tips**, and then the connection diagram of the ripple analysis is displayed on the screen. Please connect the cables according to the connection method as shown in Figure 8-2. Press **Tips** again or enable the touch screen to tap the icon  at the right-upper corner of the connection diagram window to close it.

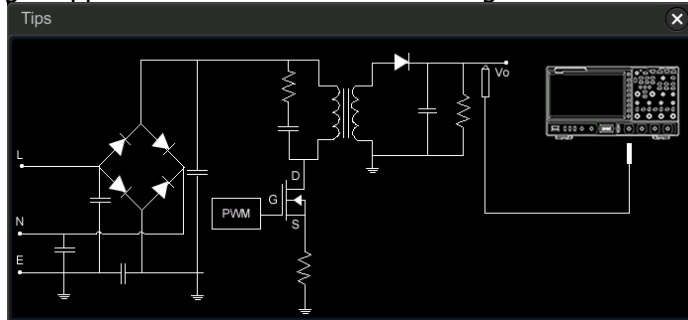

Figure 8-2 Connection Diagram of Ripple Analysis



## Chapter 9 Histogram Analysis

MSO5000 series oscilloscope supports the standard histogram analysis function, enabling you to judge the trend of waveforms, and quickly locate the potential problems of the signal.

Contents in this chapter:

- To Enable or Disable the Histogram Function
- To Select the Histogram Type
- To Select the Histogram Source
- To Set the Histogram Height
- To Set the Histogram Range
- To Enable or Disable the Statistical Function
- To Reset

## To Enable or Disable the Histogram Function

The histogram analysis function supported by the MSO5000 series is available to provide a statistical view of waveforms or measurement results. It can be classified into horizontal histogram, vertical histogram, and measurement histogram. With the on-going acquisition and measurement of the waveforms, the height of the bar graph will change within the set range of the histogram window to indicate the number of times for data statistics.

You can enter the "Histogram" setting menu through the following three methods:

- Press **Measure** on the front panel, select **Analyze** → **Histogram** to enter the "Histogram" setting menu.
- You can also enable the touch screen and then tap the function navigation icon  at the lower-left corner of the screen to open the function navigation. Then, tap the "Histogram" icon, and then the histogram setting menu is displayed at the right section of the screen.
- Refer to descriptions in "**Rectangle Drawing**" to enter the "Histogram" setting menu.

Press **Enable** continuously to enable or disable the histogram analysis function.

### Tip

To record peaks or glitches in the histogram data, please always enable the histogram function.

## To Select the Histogram Type

The histogram includes the following three types:

- Horizontal: displays the number of times for statistics making in the forms of columns in the histogram bar graph at the bottom of the graticule.
- Vertical: displays the number of times for statistics making in the forms of rows in the histogram bar graph at the left of the graticule.
- Measure: displays the number of times for statistics of the measurement results in the forms of columns in the histogram bar graph at the bottom of the graticule.

Press **Type**, then rotate the multifunction knob  to select the desired histogram type, and then press down the knob to select the type. You can also press **Type** continuously or enable the touch screen to select the type.

## To Select the Histogram Source

If "Horizontal" or "Vertical" is selected under **Type**, you need to set the source (CH1-CH4). Press **Source**, then rotate the multifunction knob  to select the desired source, and then press down the knob to select the source. You can also press **Source** continuously or enable the touch screen to select it.

When you select "Measure" as the histogram type, press **Measure** on the front panel to enter the measurement setting menu, and then add one or multiple measurement items. The added measurement item(s) can be served as the histogram source(s).

## To Set the Histogram Height

The histogram height indicates the number of grids the histogram bar graph should use on the screen. Press **Height**, then rotate the multifunction knob  or use the pop-up numeric keypad to set the height. The available range of height is from 1 to 4. By default, it is 2.

## To Set the Histogram Range

When "Horizontal" or "Vertical" is selected under **Type**, you need to set the window range. Set "Left Limit", "Right Limit", "Top Limit", and "Bottom Limit" respectively to adjust the size and position of the histogram window. Press **Range** to enter the sub-menu of histogram range. Then press the corresponding softkey and rotate the multifunction knob  to set their values.

**Note:** The adjustment for the horizontal time base and vertical scale will not affect the time base of the histogram range, but only shows variation with the scale.

## To Enable or Disable the Statistical Function

Press **Statistic** to enable or disable the statistical function. When the statistical function is enabled, the statistical results of the histogram data will be displayed, as shown in the following figure. Note that when you select "Measure" under **Type**, the statistical data results also include the parameter XScale.

Histogram Result	
Sum	1.243Mhits
Peaks	3.1khits
Max	1.99us
Min	-2.01us
Pk_Pk	4us
Mean	-15ns
Median	-20ns
Mode	-2.01us
Bin width	10ns
Sigma	1.154us

- Sum: indicates the sum of all bins (buckets) in the histogram.
- Peaks: indicates the maximum number of hits in any single bin.
- Max: indicates the maximum value within the histogram range.
- Min: indicates the minimum value within the histogram range.
- Pk\_Pk: indicates the Delta between the max. value and the min. value.
- Mean: indicates the average value of the histogram.
- Median: indicates the median value of the histogram.
- Mode: indicates the mode value of the histogram.
- Bin width: indicates the width of each bin (bucket) in the histogram.
- Sigma: indicates the standard deviation of the histogram.

## To Reset

Press **Reset** to reset the statistical data and restart to make statistics.



# Chapter 10 Digital Channel

MSO5000 series oscilloscope has an standard configuration of the logic analyzer (LA) function, and it has 16 digital channels. The default channel label is D15-D0. The oscilloscope compares the voltages acquired in each sample with the preset logic threshold. If the voltage of the sample point is greater than the threshold, it will be stored as logic 1; otherwise, it will be stored as logic 0. The oscilloscope displays logic levels ("1" and "0") in the form of a graph for you to easily detect and analyze the errors in circuit design (hardware design and software design).

Before using the digital channels, connect the oscilloscope and the device under test using PLA2216 active logic probe option. To apply to different application scenarios, PLA2216 provides two connection methods to connect the signal under test. For details, refer to *PLA2216 Active Logic Probe User's Guide*.

**Note:** The digital channel input terminal does not support hot plug. Please do not insert or pull out the logic probe when the instrument is powered on.

Contents in this chapter:

- To Select the Digital Channel
- To Enable/Disable the Digital Channel
- To Set the Threshold and Calibrate Probe
- Auto Arrangement Setting
- To Set the Waveform Display Size
- To Set the Label
- Group Setting
- Waveform Color of the Digital Channel

## To Select the Digital Channel

Press **LA** on the front panel to enter the LA setting menu. Press **Select** to open the channel menu, and rotate the multifunction knob  to select the channel. You can also press **Select** continuously or enable the touch screen to select it.

- Select any of the digital channels (D0-D15). The channel label and waveform of the selected channel are displayed in red.
- Select the user-defined group: selects any group of the channels from the four user-defined groups. All the channel labels and waveforms in the selected channel group are displayed in red.

**Note:** Only the enabled digital channel can be selected, and only the user-defined channel group that has been grouped can be available.

For how to enable the digital channel/group, refer to descriptions in "**To Enable/Disable the Digital Channel**".

For how to define the channel group, refer to refer to descriptions in "**Group Setting**".

## To Enable/Disable the Digital Channel

Press **On/Off** to enter the on/off sub-menu of the digital channel.

- **Enable/disable the channels (D7-D0) simultaneously**

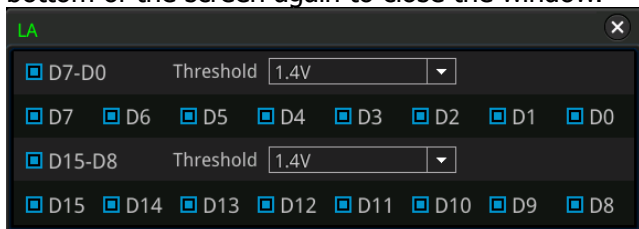

Press **D7-D0** continuously to enable or disable the channels (D7-D0). You can also enable the touch screen to tap the digital channel status area at the bottom of the screen. The LA window is displayed, as shown in the figure below. In the window, you can select the LA channel and set the threshold. Tap "D7-D0" to enable or disable the D7-D0 channels. You can also tap the  icon at the upper-right corner of the window or tap the digital channel status area at the bottom of the screen again to close the window.



- **Enable/disable the channels (D15-D8) simultaneously**



Press **D15-D8** continuously to enable or disable the channels (D15-D8). You can also enable the touch screen to tap the digital channel status area at the bottom of the screen. The LA window is displayed. In the window, you can select the LA channel and set the threshold. Tap "D15-D8" to enable or disable the D15-D8 channels.

- **Enable/disable a single digital channel**

Press **Dx On/Off** to open the channel selection list. Rotate the multifunction knob  to select a channel, and then press down the knob to enable or disable it. You can also press **Dx On/Off** continuously to switch to select any channel, and press down the multifunction knob  to enable or disable the channel. You can also enable the touch screen to enable or disable the selected channel. Besides, you can also enable the touch screen to tap the digital channel status area at the bottom of the screen. Then, the LA window is displayed. In the window, you can select the LA channel and set the threshold. Tap a single channel to enable or disable the channel.

**Note:** While pressing **D7-D0** to disable all the channels D7-D0, you can still disable or enable any channel among D7-D0 through the **Dx On/Off** key. While pressing **D7-D0** to enable D7-D0, the D0-D7 channels under **Dx On/Off** are enabled automatically. The same is true for D15-D8 channels.

- **Enable or disable user-defined channel group**

Press **Group On/Off**, then rotate the multifunction knob  to select the specified channel group. Press down the knob to enable or disable all the channels in this channel group. You can also enable the touch screen to tap the specified group and select it. The enabled channel groups are marked with , and the disabled channel groups are marked with .

**Note:** This function is only valid when the channels have been grouped by users. For how to carry out group settings, refer to descriptions in "**Group Setting**".

## To Set the Threshold and Calibrate Probe

- **Threshold Setting**

The threshold levels of channels D7-D0 and channels D15-D8 can be set separately according to your needs. Press **Threshold** to enter the threshold setting menu. When the voltage of the input signal is greater than the currently set threshold, it is treated as logic 1; otherwise, it is treated as logic 0.

Press **D7-D0** or **D15-D8** respectively to open the threshold selection list and select the preset threshold. The available preset values include TTL(1.40 V), CMOS5.0(2.5 V), CMOS3.3(1.65 V), CMOS2.5(1.25 V), CMOS1.8(0.9 V), ECL(-1.3 V), PECL(3.7 V), LVDS(1.2 V), and 0 V. You can also press **D7-D0** or **D15-D8** respectively, then rotate the multifunction knob  at a small step value or use the pop-up numeric keypad to set the desired threshold.

Besides, you can also enable the touch screen to tap the digital channel status area at the bottom of the screen. Then, the LA window is displayed. In the window, you can select the LA channel and set the threshold. Tap the  icon at the right side of the threshold field, and then the threshold selection list is

displayed. Tap to select the preset threshold. Or tap the threshold input field and input the value with the pop-up numeric keypad.

- **Probe Calibration**

When the probe is connected to the oscilloscope for the first time or the temperature change is more than 5 degrees, you are recommended to calibrate the probe zero using the calibration function. Please disconnect all the connections to the PLA2216 input terminal during the calibration.

Press **Threshold** → **Calibration** to calibrates the probe zero automatically.

## Auto Arrangement Setting

Press **Arrange** to select the waveform arrangement order of the currently enabled channels on the screen. You can select "D0-D15" or "D15-D0", and the default is "D0-D15".

- D0-D15: the waveforms on the screen are D0-D15 in sequence from top to bottom.
- D15-D0: the waveforms on the screen are D15-D0 in sequence from top to bottom.

## To Set the Waveform Display Size

Press **Size**, and rotate the multifunction knob  to set the waveform display size. Press down the knob to select it. You can also press **Size** continuously or enable the touch screen to select it. The available display sizes are Small, Medium, and Large.

**Note:** "Large" is only available when the number of currently enabled channels is less than or equal to 8.

## To Set the Label

By default, the instrument takes D0-D15 as the channel label of the 16 digital channels. You can set a user-defined label for each digital channel to easily differentiate the digital channels. You can use the preset label or input a label manually. Press **Label** to enter the label setting menu.

- **Enable or disable the label display**



Press **Display** continuously to enable or disable the display of the channel label. If it is enabled, the label will be displayed at the left side of the waveform.

- **Select a specified digital channel**  
Press **Select** and rotate the multifunction knob  to select the desired digital channel that needs a label. You can also press **Select** continuously or enable the touch screen to select the channel. Select any channel from D0-D15.
- **Use preset labels**  
Press **Library** to select a preset label. The available preset labels include ACK, AD0, ADDR, BIT, CAS, CLK, CS, DATA, HALT, INT, LOAD, NMI, OUT, PAS, PIN, RDY, RST, RX, TX, WR, MISO, and MOSI.
- **Input a label manually**  
Press **Label** to open the label input interface. You can input the label manually. For details, refer to descriptions in "**Channel Label**".

## Group Setting

Press **On/Off** → **Group** to enter the user-defined group setting menu. You can randomly grouping or ungrouping any channels of the 16 digital channels. You can also directly press **More** to enter the menu to group or ungroup channels according to your needs.

- **Group:**  
For grouping, the operations for the 4 user-defined groups (Group1, Group2, Group3, and Group4) are the same. Here take Group1 as an example.

Press **Group1** to open the D0-D15 channel selection list (the status icon is located at the left side of each channel). Rotate the multifunction knob  or press **Group1** continuously to select the channel(s) to be added to Group1. Then, press down the multifunction knob to add the selected channel(s) to Group1. The channel(s) that has/have been added to Group1 is/are marked with the status icon , and the channel(s) that has/have not been added to Group1 is/are marked with the status icon .

Use the same method to group the other channels. Each channel can only be added to one single group, and the channels that have been added to other group cannot be selected. You can perform group operation on 16 digital channels (D0-D15).

- **Ungroup:**  
Press **UnGroup** to open the group list. Rotate the multifunction knob  or press **UnGroup** continuously to select any channel group, then press down the knob to ungroup the channels.

### Note:













- You can only ungroup the digital channels.

- If no group is set, the **Ungroup** menu and the **Group On/Off** menu are grayed out and disabled.

## Waveform Color of the Digital Channel

When the digital channel is enabled, its corresponding waveforms and label are displayed on the screen. This oscilloscope supports setting high logic level display color, low logic level display color, and edge display color.

Press **More** → **Color** to enter the waveform color setting menu.

- Press **High**, and rotate the multifunction knob  to set the color of high logic level. Press down the knob to select it. You can also press **High** continuously or enable the touch screen to select it. Three colors are available: , , and .
- Press **Edge**, and rotate the multifunction knob  to set the edge color. Press down the knob to select it. You can also press **Edge** continuously or enable the touch screen to select it. Three colors are available: , , and .
- Press **Low**, and rotate the multifunction knob  to set the color of low logic level. Press down the knob to select it. You can also press **Low** continuously or enable the touch screen to select it. Three colors are available: , , and .

# Chapter 11 Protocol Decoding

You can use the protocol analysis to discover errors, debug hardware, and accelerate development easily, ensuring you to accomplish the projects with high speed and good quality. Protocol decoding is the basis of protocol analysis. Only protocol analyses with correct protocol decoding are acceptable, and only correct protocol decoding can identify more error information. MSO5000 provides four bus decoding modules (Decode 1, Decode 2, Decode 3, and Decode 4) to make common protocol decoding (including Parallel (standard), RS232 (option), I2C (option), SPI (option), LIN (option), CAN (option), FlexRay (option), I2S (option), and 1553B (option)) for the input signals of the analog channels (CH1-CH4) and digital channels (D0-D15). As the decoding functions and setting methods of Decode1, Decode2, Decode3, and Decode4 are the same, this chapter takes Decode1 as an example for illustration.

Press **Decode** on the front panel to open the decode setting menu, or enable the touch screen and then tap the function navigation icon  at the lower-left corner of the screen to open the function navigation. Then, tap the "Decode" icon to open the decode setting menu.

To get the decoding option information, refer to descriptions in "**Appendix A: Accessories and Options**".

If you have purchased the decoding option, activate it according the descriptions in "**To View the Option Information and the Option Installation**".

Contents in this chapter:

- Parallel Decoding
- RS232 Decoding (Option)
- I2C Decoding (Option)
- SPI Decoding (Option)
- LIN Decoding (Option)
- CAN Decoding (Option)
- FlexRay Decoding (Option)
- I2S Decoding (Option)
- 1553B Decoding (Option)

## Parallel Decoding

Parallel bus consists of clock line and data line. As shown in the figure below, CLK is the clock line, whereas Bit0 and Bit1 are the 0 bit and 1st bit on the data line respectively. The oscilloscope will sample the channel data on the rising edge, falling edge, or the rising/falling edge of the clock and judge each data point (logic "1" or logic "0") according to the preset threshold level.

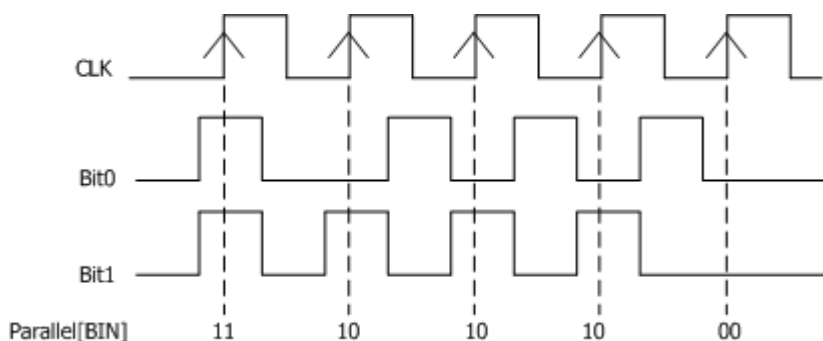



Figure 11-1 Schematic Diagram of Parallel Decoding

In the decode setting menu, press **Decode1** → **Bus Type**, then rotate the multifunction knob  to select "Parallel". Press down the knob to select it. You can also press **Bus Type** continuously or enable the touch screen to select it.

### 1. Enable or disable the bus

Press **Bus Status** to enable or disable the decoding function.





### 2. Clock setting (CLK)

Press **Clock** to enter the clock line setting menu.

#### ● Set clock channel



Press **CLK**, then rotate the multifunction knob  to select any clock channel. Press down the knob to select it. You can also press **CLK** continuously or enable the touch screen to select it. The analog channel (CH1-CH4) and digital channel (D0-D15) can all be selected as the clock source. If "OFF" is selected, no clock channel is set, and sampling is performed when a hop occurs to the data of the data channel during decoding.

#### ● Set the clock edge type

Press **CLK Edge**, then rotate the multifunction knob  to select the clock edge type. Press down the knob to select it. You can also press **CLK Edge** continuously or enable the touch screen to select it. You can select to sample the channel data on the rising edge () , falling edge () , or both edges () of the clock signal.

Rising : samples the channel data on the rising edge of the clock.



Falling : samples the channel data on the falling edge of the clock.  
 Both : samples the channel data on both the rising edge and the falling edge of the clock.

- **Set the threshold**

When the clock signal is an analog channel (CH1-CH4), you need to set a threshold. Press **Threshold**, rotate the multifunction knob  or use the pop-up numeric keypad to set the threshold.

### 3. Bus setting

Press **Bus** to enter the bus setting menu.

- **Set the bus**

Press **BUS** to select the digital bus for Parallel decoding, as shown in the following table.

Bus	Width	Bit X	Channel	Remarks
CH1	1	0	CH1	<b>Width</b> , <b>Bit X</b> , and <b>CH</b> are set automatically, and you cannot modify them.
CH2	1	0	CH2	<b>Width</b> , <b>Bit X</b> , and <b>CH</b> are set automatically, and you cannot modify them.
CH3	1	0	CH3	<b>Width</b> , <b>Bit X</b> , and <b>CH</b> are set automatically, and you cannot modify them.
CH4	1	0	CH4	<b>Width</b> , <b>Bit X</b> , and <b>CH</b> are set automatically, and you cannot modify them.
D7-D0	8	0 (default)	D0 (default)	Bit0 to Bit7 are set to D0 to D7 respectively. <b>Width</b> is set automatically, and you cannot modify them.
D15-D8	8	0 (default)	D8 (default)	Bit0 to Bit7 are set to D8 to D15 respectively. <b>Width</b> is set automatically, and you cannot modify them.
D15-D0	16	0 (default)	D0 (default)	Bit0 to Bit15 are set to D0 to D15 respectively. <b>Width</b> is set automatically, and you cannot modify them.
D0-D7	8	0 (default)	D7 (default)	Bit0 to Bit7 are set to D7 to D0 respectively. <b>Width</b> is set automatically, and you cannot modify them.

D8-D15	8	0 (default)	D15 (default)	Bit0 to Bit7 are set to D15 to D8 respectively. <b>Width</b> is set automatically, and you cannot modify them.
D0-D15	16	0 (default)	D15 (default)	Bit0 to Bit15 are set to D15 to D0 respectively. <b>Width</b> is set automatically, and you cannot modify them.
User	1-20, by default, 16	0 (default)	D15 (default)	Bit0 to Bit19 are set to D15 to CH1 respectively.

● **Set the width**

When **BUS** is set to "User", you can set the bus width. Press **Width**, rotate the multifunction knob  or use the pop-up numeric keypad to set the width. The available range is from 1 to 20. By default, it is 16.

● **Specify data channel for each bit**

When **BUS** is set to any digital channel, you can specify the data channel for each bit.

Press **Bit X**, then rotate the multifunction knob  or use the pop-up numeric keypad to set the bit of the channel.

By default, 0 is selected. Its available range is from 0 to (width - 1).

Press **CH**, then rotate the multifunction knob  to select a channel source. Press down the knob to select it. You can also press **CH** continuously or enable the touch screen to select it. The analog channel (CH1-CH4) and digital channel (D0-D15) can all be selected as the channel source.

● **Set the threshold level**

To judge logic "1" and logic "0" of the buses, you need to set a threshold for each analog channel (CH1-CH4). When the channel signal amplitude is greater than the preset threshold, it is judged as logic "1"; otherwise logic "0". Press **Threshold**, rotate the multifunction knob  or use the pop-up numeric keypad to set the threshold.

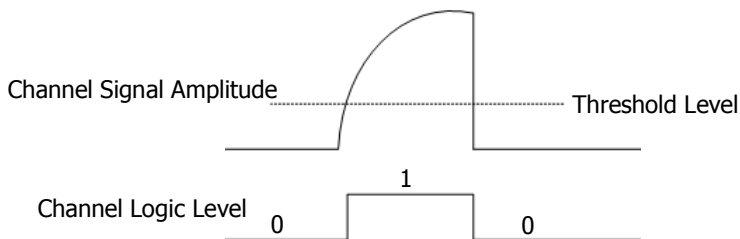

● **Set the endian**

Press **Endian** continuously to select "Normal" or "Invert" as the endian of the bus.

- **Polarity**

Press **Polarity** continuously to select Positive  or Negative  as the polarity for data decoding.

#### 4. Display-related setting

Press **Display** to enter the display setting menu.

- **Set the display format**

Press **Format**, rotate the multifunction knob  to select the display format of the bus data. Then, press down the knob to select it. You can also press **Format** continuously or enable the touch screen to select it. The available display formats of the bus data are "Hex", "Dec", "Bin", and "ASCII".

- **Adjust the vertical position of the bus**



Press **Position**, and then rotate the multifunction knob  to adjust the vertical display position of the bus.

- **Set the label display**

Press **Label** to enable or disable the label display of the Parallel decoding bus. When enabled, the bus label "Parallel" will be displayed at the upper-left side of the bus (when the bus display is enabled).

- **Event table**

Press **Event Table** to enter the event table setting menu. The event table displays the detailed decoding information in time order in the form of a table, so as to better observe the long decoded data. The decoding information includes the decoded data, the corresponding line number, and time information.

- Open or close the event table: Press **Event Table** continuously to enable or disable the event table. When you enable the event table, the following figure is displayed, as shown in Figure 11-2. You can also enable the touch screen to tap the icon  at the upper-right corner of the table to close the event table. Besides, you can also rotate the multifunction knob  to select a specified line and view the corresponding decoding information.

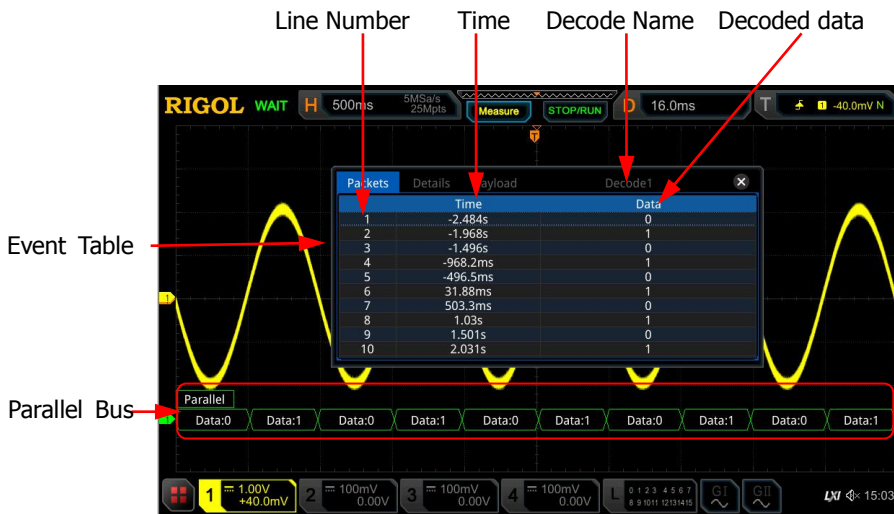



Figure 11-2 Parallel Decoding Event Table

**Note:**

- When you adjust the horizontal time base, the waveform displayed on the screen will also change, and the total number of lines containing the decoding information in the event table will also be changed.
  - The displayed decoded data information in the bus is related to the value of the horizontal time base. Reducing the horizontal time base can help you view the detailed information.
- Set the event table format: Press **Format**, rotate the multifunction knob to select the display format of "Data" in the event table. Then, press down the knob to select it. You can also press **Format** continuously or enable the touch screen to select it. The available formats include "Hex", "Dec", "Bin", and "ASC".
  - Set the view type: Press **View**, then rotate the multifunction knob to select the form of the event table to be viewed. Press down the knob to select it. You can also press **View** continuously or enable the touch screen to select it. The available choices include "Packets", "Details", and "Payload". You can also tap "Packets", "Details", or "Payload" at the top of the event table to select it.
- If you select "Packets", the time and decoded data are displayed in the event table. If you select "Details", the detailed data in the specified row will be displayed in the event table. If "..." appears in the row of data, it indicates that the decoded data are not fully displayed. At this time, you can view the details in the "Packets" view. If you select "Payload", all data in the specified column will be displayed in the event table. If "..." appears in the specified column of data, it indicates that the decoded data are not fully displayed. At this time, you can view the

- details in the "Packets" view.
- **Export:** If you select "Packets", you can export time and the corresponding decoded data. Press **Export**, the save setting menu is displayed. You can export the data table of the packets to the internal or external USB storage device (when detected) in CSV format. For detailed saving operation, refer to descriptions in "**Store and Load**".
  - **Jump to:** Set the operating status of the oscilloscope to "STOP". Then, select the data of the specified time from the event table. Press **Jump to** and the specified data waveforms are displayed in the center of the screen.
  - **Decode:** The setting of this menu enables you to quickly view the corresponding event tables of four decode modules (Decode1, Decode2, Decode3, and Decode4). Press **Decode** and rotate the multifunction knob  to select a decode module, then press down the knob to select it. You can also press **Decode** continuously or enable the touch screen to select it.

## 5. Noise rejection

Press **Settings** → **Noise Reject** to enable or disable the noise rejection function. Noise rejection can remove the data that last not enough time on the bus and eliminate the burst glitch in the actual circuit. When the noise rejection is enabled, press **Reject Time**, rotate the multifunction knob  or use the pop-up numeric keypad to set the desired rejection time. The available range of the rejection time is from 0 s to 1 s.

## RS232 Decoding (Option)

RS232 serial bus consists of the transmitting data line (TX) and the receiving data line (RX).

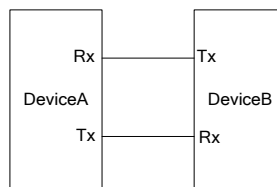

Figure 11-3 Schematic Diagram of RS232 Serial Bus

The industry standard of RS232 uses "Negative Logic", i.g. high level is logic "0" and low level is logic "1".

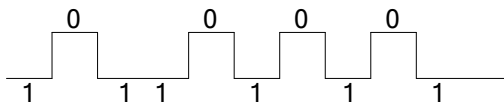

Figure 11-4 Schematic Diagram of Negative Logic

In RS232, baud rate is used to represent the transmission rate (namely bits per second) of the data. You need to set the start bit, data bits, check bit (optional), and stop bit for each frame of data.

Start Bit	Data Bit	Check Bit	Stop Bit
-----------	----------	-----------	----------

**Start Bit:** indicates when to output data.

**Data Bit:** indicates the number of data bits actually contained in each frame of data.

**Check Bit:** used to check whether the data are properly transmitted.

**Stop Bit:** indicates when to stop outputting data.

In the decode setting menu, press **Decode1** → **Bus Type**, then rotate the multifunction knob  to select "RS232". Press down the knob to select it. You can also press **Bus Type** continuously or enable the touch screen to select it.

**1. Enable or disable the bus**

Press **Bus Status** to enable or disable the decoding function.

**2. Quickly apply RS232 trigger settings to RS232 decoding**

Press **Copy Trig** to copy the current RS232 trigger settings and apply them to RS232 decoding function (set the corresponding RS232 decoding parameters automatically). For source channels, copy the source channel of the trigger to the Tx source channel of the decoding. For analog channels, the threshold level settings will also be copied.

**3. Set the baud rate**



Three setting methods are available for baud rate:

- Press **Baud**, then set the user-defined baud rate with the displayed numeric keypad.
- Press **Baud**, then select the preset baud rate from the available options. The available baud rates include 50 bps, 75 bps, 110 bps, 134 bps, 150 bps, 300 bps, and etc.
- Press **Baud**, then rotate the multifunction knob  to adjust the baud rate at a small step of 1 bps.

#### 4. Source setting

Press **Sources** to enter the source setting menu.

- **Set the Tx source and the threshold**



- Press **Tx** and rotate the multifunction knob  to select the desired channel, and then press down the knob. You can also press **Tx** continuously or enable the touch screen to select it. The available channels include OFF, CH1-CH4, and D0-D15.
- When you select the analog channel (CH1-CH4), press **Threshold**, then rotate the multifunction knob  or use the pop-up numeric keypad to adjust the threshold of Tx source. When you modify the threshold of the Tx source channel, a dotted line displaying the current threshold level is displayed on the screen. The dotted line disappears in about 2 s after you stop modifying the threshold.

- **Set the Rx source and the threshold**

Use the same method to select the Rx source and set the threshold (only when the Rx source channel is set to an analog channel (CH1-CH4)).

**Note:** The Tx and Rx source channels cannot be set to "OFF" at the same time.

- **Polarity**

Press **Polarity** continuously to select the polarity of data transmission. It can be set to "" (positive) or "" (negative).

- Normal: Use negative logic. High level indicates logic "0"; low level indicates logic "1".
- Invert: Use positive logic. High level indicates logic "1"; low level indicates logic "0".

#### 5. Set data package

Press **Settings** to enter the data package setting menu.

- **Data**

Press **Data** and rotate the multifunction knob  to set the number of data bits actually contained in each frame of data. Press down the knob to select it. You can also press **Data** continuously or enable the touch screen to select it. The available data bits are 5 bits, 6 bits, 7 bits, 8 bits, and 9 bits.

- **Parity**

It is used to check whether the data transmission is correct. Press **Parity** and rotate the multifunction knob  to select the desired parity mode, then press down the knob to select it. You can also press **Parity** continuously or enable the touch screen to select it.

- None: indicates that no check bit appears during the transmission.
- Even: indicates that the total number of "1" in the data bit and check bit is an even number. For example, when 0x55 (01010101) is sent, "0" should be added to the check bit.
- Odd: indicates that the total number of "1" in the data bit and check bit

is an odd number. For example, when 0x55 (01010101) is sent, "1" should be added to the check bit.

- **Stop Bit**

Press **Stop Bit** and rotate the multifunction knob  to set the stop bits after each frame of data. Press down the knob to select it. You can also press **Stop Bit** continuously or enable the touch screen to select it. It can be set to 1 bit, 1.5 bits, or 2 bits.

- **Endian**

Press **Endian** to select "LSB" or "MSB". By default, it is "LSB".

LSB: indicates Least Significant Bit transmission sequence, i.g. the lowest bit of the data is transmitted first.

MSB: indicates Most Significant Bit transmission sequence, i.g. the highest bit of the data is transmitted first.

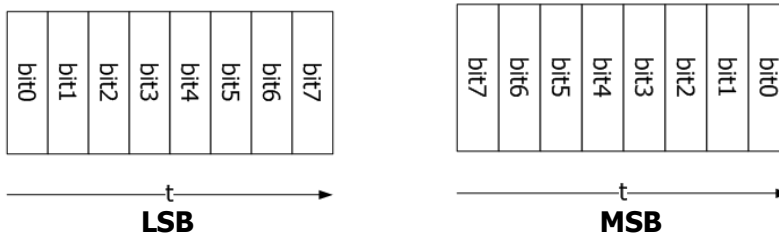

- **Package**

Press **Package** to enable or disable the package display in data transmission. When enabled, several data blocks will be combined based on the separator.

- **Separator**

Press **Separator** and rotate the multifunction knob  to select the desired package separator in data transmission, then press down the knob to select it. You can also press **Separator** continuously or enable the touch screen to select it. It can be set to 0A(LF), 0D(CR), 20(SP), or 0(NUT).





## 6. Display-related setting

Press **Display** to enter the display setting menu.

- **Set the display format**

Press **Format**, rotate the multifunction knob  to select the display format of the bus data. Then, press down the knob to select it. You can also press **Format** continuously or enable the touch screen to select it. The available display formats of the bus data are "Hex", "Dec", "Bin", and "ASCII".



- **Adjust the vertical position of the bus**  
Press **Position**, and then rotate the multifunction knob  to adjust the vertical display position of the bus.
- **Set the label display**  
Press **Label** to enable or disable the label display of the RS232 decoding bus. When enabled, the bus label "RS232-TX" and/or "RS232-RX" will be displayed at the upper-left side of the bus (when the bus display is enabled).
- **Event table**  
Press **Event Table** to enter the event table setting menu. The event table displays the detailed decoding information in time order in the form of a table, so as to better observe the long decoded data. The decoding information includes the decoded data (Tx and/or Rx), the corresponding line number, time, and error information (Tx and/or Rx).  
**Note:** When the Tx and Rx source channels are set to "OFF", information of the data line is not displayed in the data table.
  - Open or close the event table: Press **Event Table** continuously to enable or disable the event table. You can also enable the touch screen to tap the icon  at the upper-right corner of the table to close the event table. Besides, when the operating status is "STOP", you can also rotate the multifunction knob  to select a specified line and view the corresponding decoding information.  
**Note:**
    - When you adjust the horizontal time base, the waveform displayed on the screen will also change, and the total number of lines containing the decoding information in the event table will also be changed.
    - The displayed decoded data information in the bus is related to the value of the horizontal time base. Reducing the horizontal time base can help you view the detailed information.
  - Set the event table format: Press **Format**, rotate the multifunction knob  to select the display format of "Data" (Tx and/or Rx) in the event table. Then, press down the knob to select it. You can also press **Format** continuously or enable the touch screen to select it. The available formats include "Hex", "Dec", "Bin", and "ASC".
  - Set the view type: Press **View**, then rotate the multifunction knob  to select the form of the event table to be viewed. Press down the knob to select it. You can also press **View** continuously or enable the touch screen to select it. The available choices include "Packets", "Details", and "Payload". You can also tap "Packets", "Details", or "Payload" at

the top of the event table to select it.

If you select "Packets", the time and decoded data are displayed in the event table; if you select "Details", the detailed data in the specified row will be displayed in the event table; if you select "Payload", all data in the specified column will be displayed in the event table.

- Export: If you select "Packets", you can export time, the corresponding decoded data, and etc. Press **Export**, the save setting menu is displayed. You can export the data table of the packets to the internal or external USB storage device (when detected) in CSV format. For detailed saving operation, refer to descriptions in **"Store and Load"**.
- Jump to: Set the operating status of the oscilloscope to "STOP". Then, select the data of the specified time from the event table. Press **Jump to** and the specified data waveforms are displayed in the center of the screen.
- Decode: The setting of this menu enables you to quickly view the corresponding event tables of four decode modules (Decode1, Decode2, Decode3, and Decode4). Press **Decode** and rotate the multifunction knob  to select a decode module, then press down the knob to select it. You can also press **Decode** continuously or enable the touch screen to select it.

### 7. Error expressions in decoding

In RS232 decoding, parity error and/or EOF (end of frame) error may occur.

- **Parity Error**

When a parity error is detected during the decoding, red error report information will be displayed. For example, when "none" is chosen for the parity on the transmitter and "odd" is chosen for the parity on the decoder, the following parity error information  (its display form is related to the value of the horizontal time base) occurs. Wherein, the number of 1s in the 8-digit figure (00000100) is an odd number, and the parity bit should be 0. However, the parity bit detected on the Tx is 1; thus a parity error occurs.



- **EOF Error**

This error is generated when the EOF condition is not met. For example, if the **Stop Bit** is set to 1.5, but the actual stop bits is less than 1.5 bits, then the red error report information **S** (its display form is related to the value of the horizontal time base) is displayed in the following figure.

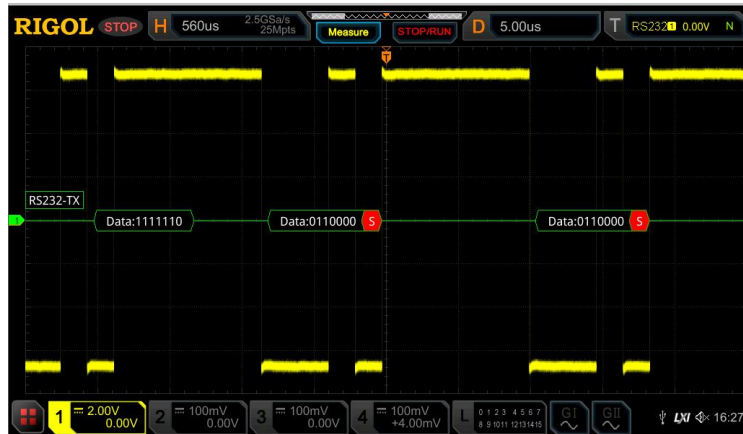

- **Parity Error and EOF Error**

When both the parity error and the EOF error are detected, the error report information (its display form is related to the value of the horizontal time base), as shown in the following figure, will be displayed.

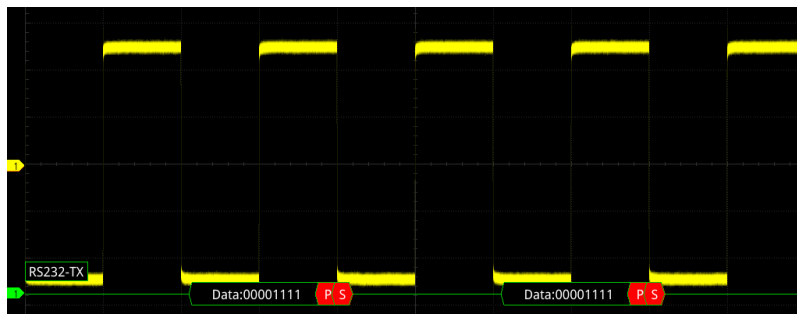

## I2C Decoding (Option)

The oscilloscope samples the LIN signal, and judges each data point to be logic "1" or logic "0" according to the preset threshold level. I2C serial bus consists of the clock line (SCLK) and the data line (SDA).

**SCL:** samples SDA on the rising or falling edge of the clock.

**SDA:** indicates the data channel.

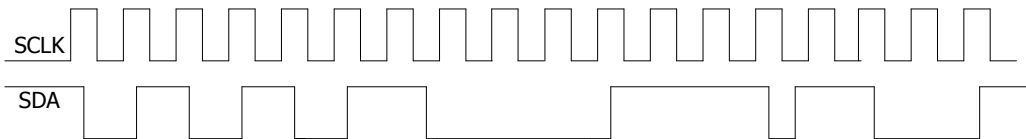



Figure 11-5 I2C Serial Bus

In the decode setting menu, press **Decode1** → **Bus Type**, then rotate the multifunction knob  to select "I2C". Press down the knob to select it. You can also press **Bus Type** continuously or enable the touch screen to select it.

### 1. Enable or disable the bus

Press **Bus Status** continuously to enable or disable the decoding function.



### 2. Quickly apply I2C trigger settings to I2C decoding

Press **Copy Trig** to copy the clock signal and data signal settings (SCL and SDA) of the current I2C trigger settings and apply them to I2C decoding function (SCL and SDA). For analog channels, the threshold level settings will also be copied.

### 3. Source setting





Press **Sources** to enter the source setting menu.

#### ● Set the clock channel source and the threshold

- Press **SCL** and rotate the multifunction knob  to select the desired source of the clock channel, and then press down the knob to select it. You can also press **SCL** continuously or enable the touch screen to select it. The available channels include CH1-CH4 and D0-D15.
- When you select the analog channel (CH1-CH4), press **SCL Thre**, then rotate the multifunction knob  or use the pop-up numeric keypad to adjust the threshold of the clock channel. When you modify the threshold of the clock channel, a dotted line displaying the current threshold level is displayed on the screen. The dotted line disappears in about 2 s after you stop modifying the threshold.

#### ● Set the data channel source and the threshold

Use the same method to select the source of the data channel and set the threshold (only when the source of the data channel is set to an analog channel (CH1-CH4)).

- **Exchange sources**  
Press **Exchange** to select "SCL/SDA" or "SDA/SCL" to exchange the sources of the current clock channel and data channel.
- 4. Specify whether the address information includes the "R/W" bit**  
For I2C bus, each frame of data starts with the address information. The address information includes the read address and the write address. Press **R/W** continuously to select whether the address information includes the "R/W" bit. When "With" is selected, the "R/W" bit will be included in the address information and located at the lowest bit; when "Without" is selected, the "R/W" bit will not be included in the address information.
- 5. Display-related setting**  
Press **Display** to enter the display setting menu.
- **Set the display format**  
Press **Format**, rotate the multifunction knob  to select the display format of the bus data. Then, press down the knob to select it. You can also press **Format** continuously or enable the touch screen to select it. The available display formats of the bus data are "Hex", "Dec", "Bin", and "ASCII".
  - **Adjust the vertical position of the bus**  
Press **Position**, and then rotate the multifunction knob  to adjust the vertical display position of the bus.
  - **Set the label display**  
Press **Label** to enable or disable the label display of the I2C decoding bus. When enabled, the bus label "I2C" will be displayed at the upper-left side of the bus (when the bus display is enabled).
  - **Event table**  
Press **Event Table** to enter the event table setting menu. The event table displays the detailed decoding information in time order in the form of a table, so as to better observe the long decoded data. The decoding information includes the decoded data, the corresponding line number, time, and error information.
    - Open or close the event table: Press **Event Table** continuously to enable or disable the event table. When you enable the event table, the following figure is displayed, as shown in Figure 11-6. You can also enable the touch screen to tap the icon  at the upper-right corner of the table to close the event table. Besides, when the operating status is "STOP", you can also rotate the multifunction knob  to select a specified line and view the corresponding decoding information.

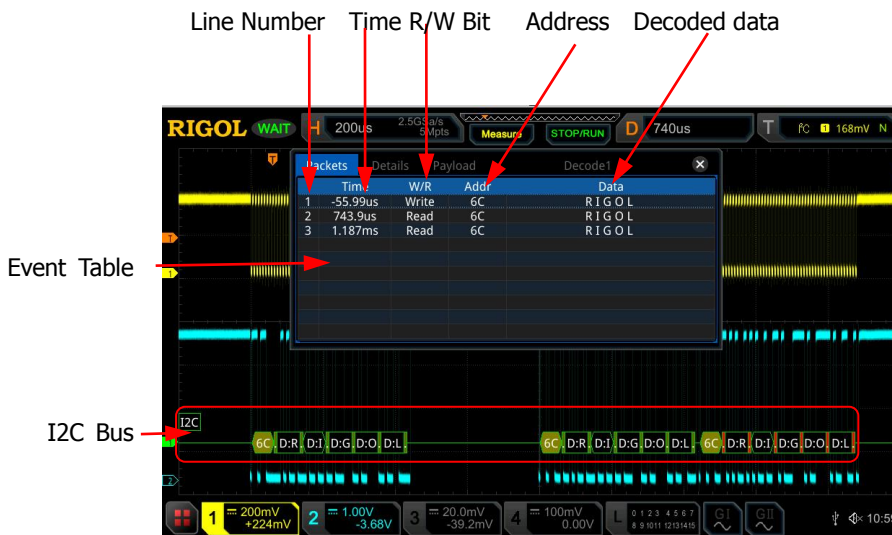





Figure 11-6 I2C Decoding Event Table

**Note:**

- When you adjust the horizontal time base, the waveform displayed on the screen will also change, and the total number of lines containing the decoding information in the event table will also be changed.
  - The displayed decoded data information in the bus is related to the value of the horizontal time base. Reducing the horizontal time base can help you view the detailed information.
- Set the event table format: Press **Format**, rotate the multifunction knob  to select the display format of "Data" in the event table. Then, press down the knob to select it. You can also press **Format** continuously or enable the touch screen to select it. The available formats include "Hex", "Dec", "Bin", and "ASC".
  - Set the view type: Press **View**, then rotate the multifunction knob  to select the form of the event table to be viewed. Press down the knob to select it. You can also press **View** continuously or enable the touch screen to select it. The available choices include "Packets", "Details", and "Payload". You can also tap "Packets", "Details", or "Payload" at the top of the event table to select it. If you select "Packets", the decoded data, time, and error information are displayed in the event table. If you select "Details", the detailed data in the specified row will be displayed in the event table. If "..." appears in the row of data, it indicates that the decoded data are not fully displayed. At this time, you can view the details in the "Packets" view. If you select "Payload", all data in the specified column will be displayed in the event table. If "..." appears in the specified column of

data, it indicates that the decoded data are not fully displayed. At this time, you can view the details in the "Packets" view.

- **Export:** If you select "Packets", you can export time, the corresponding decoded data, and etc. Press **Export**, the save setting menu is displayed. You can export the data table of the packets to the internal or external USB storage device (when detected) in CSV format. For detailed saving operation, refer to descriptions in "**Store and Load**".
- **Jump to:** Set the operating status of the oscilloscope to "STOP". Then, select the data of the specified time from the event table. Press **Jump to** and the specified data waveforms are displayed in the center of the screen.
- **Decode:** The setting of this menu enables you to quickly view the corresponding event tables of four decode modules (Decode1, Decode2, Decode3, and Decode4). Press **Decode** and rotate the multifunction knob  to select a decode module, then press down the knob to select it. You can also press **Decode** continuously or enable the touch screen to select it.

## 6. Address information in decoding

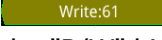
In I2C bus, each frame of data starts with the address information (include the read address and write address). In the address information, "Read" denotes the read address (e.g. ) and "Write" denotes the write address (e.g. ) You can also set the address information to include or exclude the "R/W" bit.

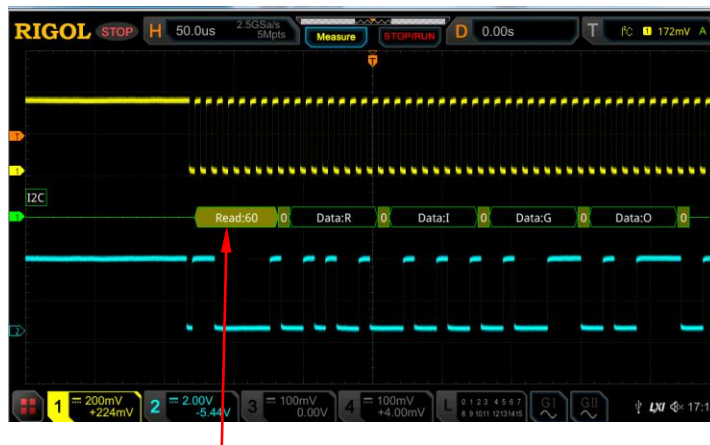

Address Information (Read Address)

## 7. Error expressions in decoding

In I2C decoding, when ACK (acknowledgement) is 1, ACK error occurs. When when the detected ACK is 1, red error report information  (the display form is related to the value of the horizontal time base and the display format of the bus) is displayed.

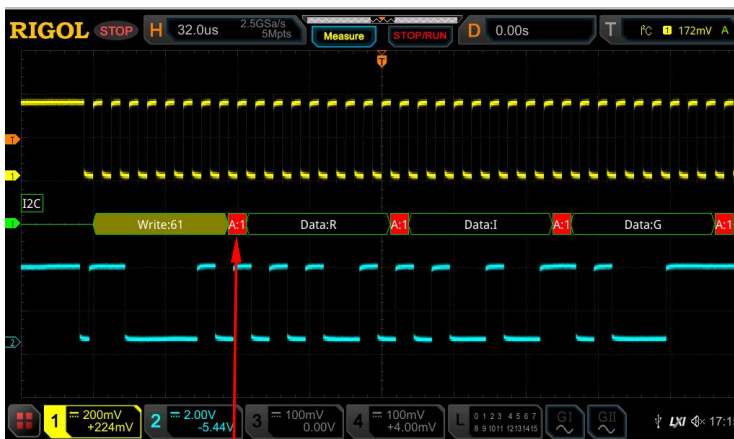

The detected ACK is 1

## SPI Decoding (Option)

SPI bus is based on the master-slave configuration and usually consists of chip select line (CS), clock line (SCLK), and data line (SDA). Wherein, the data lines include the master input/slave output (MISO) data line and master output/slave input (MOSI) data line. The oscilloscope samples the channel data on the rising or falling edge of the clock signal (if the source is an analog channel, the oscilloscope will also judge each data point (logic "1" or logic "0") according to the preset threshold level).

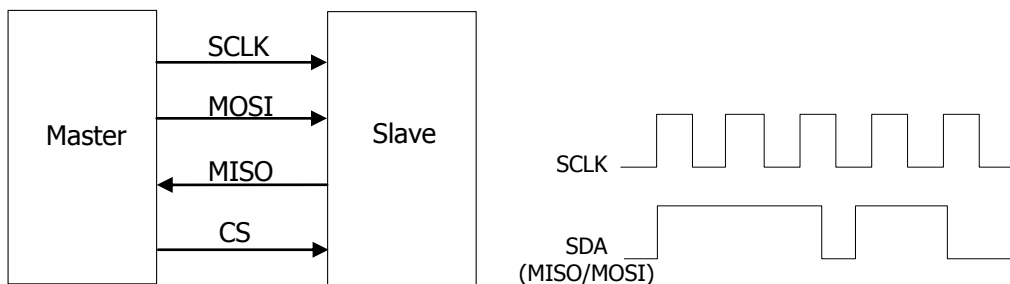

Figure 11-7 SPI Serial Bus

In the decode setting menu, press **Decode1** → **Bus Type**, then rotate the multifunction knob to select "SPI". Press down the knob to select it. You can also press **Bus Type** continuously or enable the touch screen to select it.

### 1. Enable or disable the bus

Press **Bus Status** to enable or disable the decoding function.







## 2. Quickly apply SPI trigger settings to SPI decoding

Press **Copy Trig** to copy the SPI trigger settings and apply them to SPI decoding function (set the corresponding SPI decoding parameters automatically). For analog channels, the threshold level settings will also be copied.





## 3. Mode



Press **Mode** to enter the mode setting menu. Press **Mode** continuously to select "Timeout" or "CS".

- Timeout: you can perform frame synchronization according to the timeout, and the timeout value must be greater than half of the clock cycle. Press **Timeout**, and then rotate the multifunction knob  or use the pop-up numeric keypad to set the timeout value. The available range of the timeout value is from 8 ns to 10 s. By default, it is 1 μs.
- CS: contains a chip select line (CS). You can perform frame synchronization according to CS. When "CS" is selected,
  - Press **CS** and rotate the multifunction knob  to select the desired channel, and then press down the knob to select it. You can also press **CS** continuously or enable the touch screen to select it. The analog channel (CH1-CH4) and digital channel (D0-D15) can all be selected as the CS channel.
  - Press **CS Polarity** continuously to select  (Positive) or  (Negative) as the polarity for CS channel.
  - When you select the analog channel (CH1-CH4) as the CS channel, press **Threshold**, then rotate the multifunction knob  or use the pop-up numeric keypad to set the threshold.

## 4. Source setting

Press **Sources** to enter the source setting menu.

- **CLK setting**
  - Press **CLK** and rotate the multifunction knob  to select the desired source of the clock channel, and then press down the knob to select it. You can also press **CLK** continuously or enable the touch screen to select it. The analog channel (CH1-CH4) and digital channel (D0-D15) can all be selected.
  - When you select the analog channel (CH1-CH4), press **Threshold** below the **CLK** menu, then rotate the multifunction knob  or use the pop-up numeric keypad to set the threshold of the clock channel.
  - Press **Slope** continuously to set the instrument to sample MISO and MOSI on the rising edge () or falling edge () of the clock signal.
- **MISO and MOSI setting**
  - Press **MISO** and rotate the multifunction knob  to select the desired MISO data channel, and then press down the knob to select it.

- You can also press **MISO** continuously or enable the touch screen to select it. The available channels include OFF, analog channels (CH1-CH4), and digital channels (D0-D15). When you select an analog channel (CH1-CH4), press **Threshold** below the **MISO** menu, then rotate the multifunction knob  or use the pop-up numeric keypad to set the threshold of the MISO data channel.
- Press **MOSI** and rotate the multifunction knob  to select the desired MOSI data channel, and then press down the knob to select it. You can also press **MOSI** continuously or enable the touch screen to select it. The available channels include OFF, analog channels (CH1-CH4), and digital channels (D0-D15). When you select an analog channel (CH1-CH4), press **Threshold** below the **MOSI** menu, then rotate the multifunction knob  or use the pop-up numeric keypad to set the threshold of the MOSI data channel.
- Note:** MISO and MOSI source channels cannot be both set to "OFF" at the same time.

## 5. Data setting

Press **Settings** to enter the data setting menu.

### ● Endian setting

Press **Endian** to select "LSB" or "MSB". By default, it is "MSB".

LSB: indicates Least Significant Bit transmission sequence, i.g. the lowest bit of the data is transmitted first.

MSB: indicates Most Significant Bit transmission sequence, i.g. the highest bit of the data is transmitted first.

### ● Polarity setting

Press **Polarity** continuously to select Positive  or Negative  as the polarity for data decoding.

### ● Width setting



Press **Width**, then rotate the multifunction knob  or use the pop-up numeric keypad to set the bits of each frame of data. The available range is from 4 to 32. By default, it is 8.

## 6. Display-related setting

Press **Display** to enter the display setting menu.

### ● Set the display format

Press **Format**, rotate the multifunction knob  to select the display format of the bus data. Then, press down the knob to select it. You can also press **Format** continuously or enable the touch screen to select it. The available display formats of the bus data are "Hex", "Dec", "Bin", and "ASCII".

- **Adjust the vertical position of the bus**  
Press **Position**, and then rotate the multifunction knob  to adjust the vertical display position of the bus.
- **Set the label display**  
Press **Label** to enable or disable the label display of the SPI decoding bus. When enabled, the bus label "SPI-MISO" and/or "SPI-MOSI" will be displayed at the upper-left side of the bus (when the bus display is enabled).
- **Event table**  
Press **Event Table** to enter the event table setting menu. The event table displays the detailed decoding information in time order in the form of a table, so as to better observe the long decoded data. The decoding information includes the decoded data (MISO and/or MOSI), the corresponding line number, time, and error information (MISO and/or MOSI).  
**Note:** When the source channel of MISO or MOSI is set to "OFF", information of the data line is not displayed in the data table.  
➤ Open or close the event table: Press **Event Table** continuously to enable or disable the event table. When you enable the event table, the following figure is displayed, as shown in Figure 11-8. You can also enable the touch screen to tap the icon  at the upper-right corner of the table to close the event table. Besides, when the operating status is "STOP", you can also rotate the multifunction knob  to select a specified line and view the corresponding decoding information.

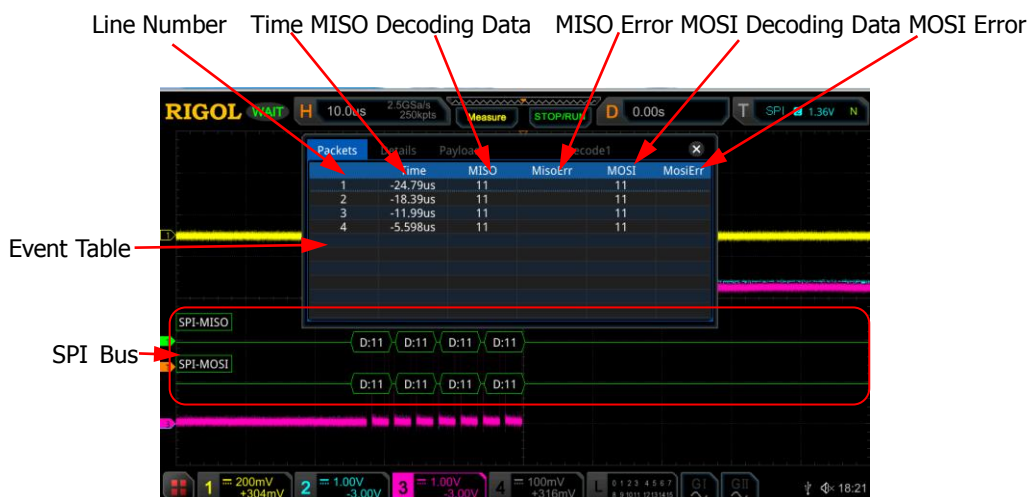





Figure 11-8 SPI Decoding Event Table



**Note:**

- When you adjust the horizontal time base, the waveform displayed on the screen will also change, and the total number of lines containing the decoding information in the event table will also be changed.
  - The displayed decoded data information in the bus is related to the value of the horizontal time base. Reducing the horizontal time base can help you view the detailed information.
- 
- Set the event table format: Press **Format**, rotate the multifunction knob  to select the display format of "Data" (MISO and/or MOSI) in the event table. Then, press down the knob to select it. You can also press **Format** continuously or enable the touch screen to select it. The available formats include "Hex", "Dec", "Bin", and "ASC".
  - Set the view type: Press **View**, then rotate the multifunction knob  to select the form of the event table to be viewed. Press down the knob to select it. You can also press **View** continuously or enable the touch screen to select it. The available choices include "Packets", "Details", and "Payload". You can also tap "Packets", "Details", or "Payload" at the top of the event table to select it.

If you select "Packets", the decoded data (MISO and/or MOSI), time, and error information (MISO and/or MOSI) are displayed in the event table. If you select "Details", the detailed data in the specified row will be displayed in the event table. If "..." appears in the row of data, it indicates that the decoded data are not fully displayed. At this time, you can view the details in the "Packets" view. If you select "Payload", all data in the specified column will be displayed in the event table. If "..." appears in the specified column of data, it indicates that the decoded data are not fully displayed. At this time, you can view the details in the "Packets" view.
  - Export: If you select "Packets", you can export time and the corresponding decoded data. Press **Export**, the save setting menu is displayed. You can export the data table of the packets to the internal or external USB storage device (when detected) in CSV format. For detailed saving operation, refer to descriptions in **"Store and Load"**.
  - Jump to: Set the operating status of the oscilloscope to "STOP". Then, select the data of the specified time from the event table. Press **Jump to** and the specified data waveforms are displayed in the center of the screen.
  - Decode: The setting of this menu enables you to quickly view the corresponding event tables of four decode modules (Decode1, Decode2, Decode3, and Decode4). Press **Decode** and rotate the multifunction knob  to select a decode module, then press down the knob to select it. You can also press **Decode** continuously or enable the touch screen to select it.

## LIN Decoding (Option)

The oscilloscope samples the LIN signal, and judges each data point to be logic "1" or logic "0" according to the preset threshold level. The LIN decoding is required to specify the LIN signal protocol version.

In the decode setting menu, press **Decode1** → **Bus Type**, then rotate the multifunction knob  to select "LIN". Press down the knob  to select it. You can also press **Bus Type** continuously or enable the touch screen to select it.



### 1. Enable or disable the bus

Press **Bus Status** continuously to enable or disable the decoding function.

### 2. Quickly apply LIN trigger settings to LIN decoding

Press **Copy Trig** to copy the LIN trigger settings and apply them to LIN decoding function (set the corresponding LIN decoding parameters automatically). For analog channels, the threshold level settings will also be copied.

### 3. Set the source and the threshold

- Press **Source** and rotate the multifunction knob  to select the desired source channel, and then press down the knob to select it. You can also press **Source** continuously or enable the touch screen to select it. The available channels include CH1-CH4 and D0-D15.
- When you select the analog channel (CH1-CH4), press **Threshold**, then rotate the multifunction knob  or use the pop-up numeric keypad to set the threshold of the source channel. When you modify the threshold of the clock channel, a dotted line displaying the current threshold level is displayed on the screen. The dotted line disappears in about 2 s after you stop modifying the threshold.

### 4. Signal setting

Press **Settings** to enter the signal setting menu.

#### ● Set baud rate

Three setting methods are available for baud rate:

- Press **Baud Rate**, then set the user-defined baud rate with the displayed numeric keypad.
- Press **Baud Rate**, then select the preset baud rate from the available options. The available baud rates include 2.4 kbps, 4.8 kbps, 9.6 kbps, 19.2 kbps, and etc.
- Press **Baud Rate**, then rotate the multifunction knob  to adjust the baud rate at a small step of 1 bps.

#### ● Set the parity bit

Press **Parity bit** continuously to select whether the data contain the parity bit.

- **Set the protocol version**

Press **Version** and rotate the multifunction knob  to select a protocol version that matches the LIN bus signal. Then, press down the knob to select it. You can also press **Version** continuously or enable the touch screen to select it. The available versions include 1.X, 2.X, and Both.

## 5. Display-related setting

Press **Display** to enter the display setting menu.

- **Set the display format**

Press **Format**, rotate the multifunction knob  to select the display format of the bus data. Then, press down the knob to select it. You can also press **Format** continuously or enable the touch screen to select it. The available display formats of the bus data are "Hex", "Dec", "Bin", and "ASCII".

- **Adjust the vertical position of the bus**

Press **Position**, and then rotate the multifunction knob  to adjust the vertical display position of the bus.

- **Set the label display**

Press **Label** to enable or disable the label display of the LIN decoding bus. When enabled, the bus label "LIN" will be displayed at the upper-left side of the bus (when the bus display is enabled).

- **Event table**

Press **Event Table** to enter the event table setting menu. The event table displays the detailed decoding information in time order in the form of a table, so as to better observe the long decoded data. The decoding information includes the decoded data, the corresponding line number, time, and error information.





- Open or close the event table: Press **Event Table** continuously to enable or disable the event table. When you enable the event table, the following figure is displayed, as shown in Figure 11-9. You can also enable the touch screen to tap the icon  at the upper-right corner of the table to close the event table. Besides, when the operating status is "STOP", you can also rotate the multifunction knob  to select a specified line and view the corresponding decoding information.



Figure 11-9 LIN Decoding Event Table

**Note:**

- When you adjust the horizontal time base, the waveform displayed on the screen will also change, and the total number of lines containing the decoding information in the event table will also be changed.
  - The displayed decoded data information in the bus is related to the value of the horizontal time base. Reducing the horizontal time base can help you view the detailed information.
- Set the event table format: Press **Format**, rotate the multifunction knob  to select the display format of "Data" in the event table. Then, press down the knob to select it. You can also press **Format** continuously or enable the touch screen to select it. The available formats include "Hex", "Dec", "Bin", and "ASC".
- Set the view type: Press **View**, then rotate the multifunction knob  to select the form of the event table to be viewed. Press down the knob to select it. You can also press **View** continuously or enable the touch screen to select it. The available choices include "Packets", "Details", and "Payload". You can also tap "Packets", "Details", or "Payload" at the top of the event table to select it.
- If you select "Packets", the decoded data, time, and error information are displayed in the event table. If you select "Details", the detailed data in the specified row will be displayed in the event table. If "..." appears in the row of data, it indicates that the decoded data are not fully displayed. At this time, you can view the details in the "Packets" view. If you select "Payload", all data in the specified column will be displayed in the event table. If "..." appears in the specified column of data, it indicates that the decoded data are not fully displayed. At this

- time, you can view the details in the "Packets" view.
- Export: If you select "Packets", you can export time and the corresponding decoded data. Press **Export**, the save setting menu is displayed. You can export the data table of the packets to the internal or external USB storage device (when detected) in CSV format. For detailed saving operation, refer to descriptions in **"Store and Load"**.
- Jump to: Set the operating status of the oscilloscope to "STOP". Then, select the data of the specified time from the event table. Press **Jump to** and the specified data waveforms are displayed in the center of the screen.
- Decode: The setting of this menu enables you to quickly view the corresponding event tables of four decode modules (Decode1, Decode2, Decode3, and Decode4). Press **Decode** and rotate the multifunction knob  to select a decode module, then press down the knob to select it. You can also press **Decode** continuously or enable the touch screen to select it.

### 6. Interpret the decoded LIN data

- Break (Sync Break): expressed in Hex, displayed as a pink patch.
- SYNC (Sync): expressed in Hex, displayed in dark yellow-green.
- ID (Frame ID): expressed in Hex, displayed in yellow-green.
- Data (Data): its display format is the same as that of the bus data (Hex, Dec, Bin, or ASCII), displayed as a black patch.
- CRC (Cyclic Redundancy Check): expressed in Hex, displayed in light yellow-green. When errors occur, it is displayed as a red patch.

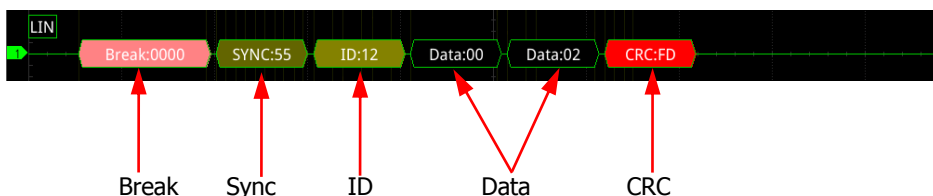

- Wakeup (wake up symbol): displayed as a tangerine patch.

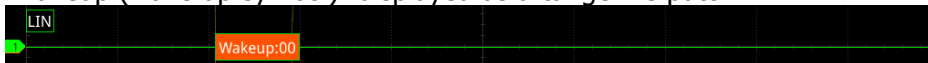

### 7. Error expressions in decoding

In LIN decoding, the parity error, checksum error, or sync error may occur.

- **Parity Error**  
If the parity error is detected, frame ID and parity bit (when the signal is set to include the parity bit) will be displayed in red, as shown in the figure below.





Parity Error

- **Checksum Error**

If the checksum error is detected, CRC is displayed in red, as shown in the figure below.

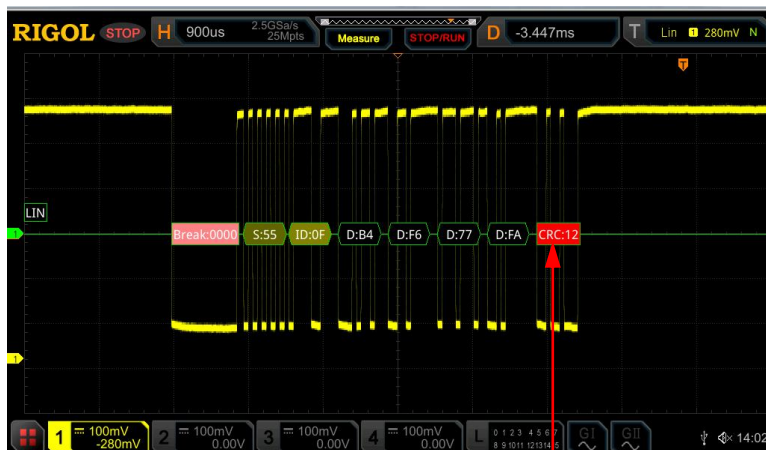

Checksum Error

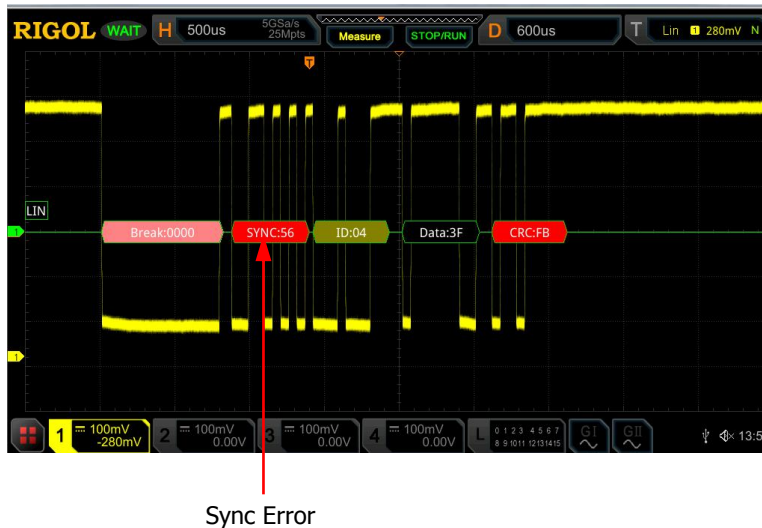

- **Sync Error**

If the sync error is detected, SYNC is displayed in red, as shown in the figure below.



## CAN Decoding (Option)

The oscilloscope samples the CAN signal at the specified sample position. The oscilloscope will also judge each data point (logic "1" or logic "0") according to the preset threshold level. You need to specify the CAN signal type and sample position for CAN decoding.

In the decode setting menu, press **Decode1** → **Bus Type**, then rotate the multifunction knob  to select "CAN". Press down the knob  to select it. You can also press **Bus Type** continuously or enable the touch screen to select it.



### 1. Enable or disable the bus

Press **Bus Status** continuously to enable or disable the decoding function.

### 2. Quickly apply CAN trigger settings to CAN decoding

Press **Copy Trig** to copy the CAN trigger settings and apply them to CAN decoding function (set the corresponding CAN decoding parameters automatically). For analog channels, the threshold level settings will also be copied.

### 3. Set the source and the threshold

- Press **Source** and rotate the multifunction knob  to select the desired source channel, and then press down the knob to select it. You can also press **Source** continuously or enable the touch screen to select it. The available channels include CH1-CH4 and D0-D15.
- When you select the analog channel (CH1-CH4), press **Threshold**, then rotate the multifunction knob  or use the pop-up numeric keypad to set the threshold of the source channel. When you modify the threshold of the

clock channel, a dotted line displaying the current threshold level is displayed on the screen. The dotted line disappears in about 2 s after you stop modifying the threshold.

#### 4. Signal setting

Press **Settings** to enter the signal setting menu.

- **Set the signal type**

Press **Signal** and rotate the multifunction knob  to select a signal type that matches the CAN bus signal. Press down the knob to select it. You can also press **Signal** continuously or enable the touch screen to select it. The available signal types include CAN\_H, CAN\_L, Rx, Tx, and Diff.

- CAN\_H: indicates the actual CAN\_H bus signal.
- CAN\_L: indicates the actual CAN\_L bus signal.
- Rx: indicates the Receive signal from the CAN bus transceiver.
- Tx: indicates the Transmit signal from the CAN bus transceiver.
- Diff: The CAN differential bus signals connected to an analog source channel by using a differential probe. Connect the probe's positive lead to the CAN\_H bus signal and connect the negative lead to the CAN\_L bus signal.

- **Specify the standard signal rate**

Three setting methods are available for baud rate:

- Press **Baud**, then set the user-defined baud rate with the displayed numeric keypad.
- Press **Baud**, then select the preset baud rate from the available options. The available baud rates include 10 kbps, 20 kbps, 33.3 kbps, 50 kbps, and etc.
- Press **Baud**, then rotate the multifunction knob  to adjust the baud rate at a small step.

- **Sample Position:**

Sample position is a point within a bit's time. The oscilloscope samples the bit level at this point. The sample position is represented by the proportion of "the time from the start of the bit to the sample position" to the "bit time", as shown in the figure below.

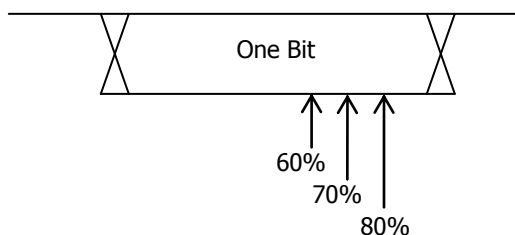



Figure 11-10 Sample Position

Press **Sample Position**, then rotate the multifunction knob  or use the pop-up numeric keypad to set the sample position. The settable range is from 10% to 90%.

## 5. Display-related Setting

Press **Display** to enter the display setting menu.

- **Set the display format**

Press **Format**, rotate the multifunction knob  to select the display format of the bus data. Then, press down the knob to select it. You can also press **Format** continuously or enable the touch screen to select it. The available display formats of the bus data are "Hex", "Dec", "Bin", and "ASCII".

- **Adjust the vertical position of the bus**



Press **Position**, and then rotate the multifunction knob  to adjust the vertical display position of the bus.

- **Set the label display**

Press **Label** to enable or disable the label display of the CAN decoding bus. When enabled, the bus label "CAN" will be displayed at the upper-left side of the bus (when the bus display is enabled).

- **Event table**

Press **Event Table** to enter the event table setting menu. The event table displays the detailed decoding information in time order in the form of a table, so as to better observe the long decoded data. The decoding information includes the decoded data, the corresponding line number, time, frame ID, data length code (DLC), cyclic redundancy check (CRC), and Acknowledgement (ACK) information.

- Open or close the event table: Press **Event Table** continuously to enable or disable the event table. When you enable the event table, the following figure is displayed, as shown in Figure 11-11. You can also enable the touch screen to tap the icon  at the upper-right corner of the table to close the event table. Besides, when the operating status is "STOP", you can also rotate the multifunction knob  to select a specified line and view the corresponding decoding information.

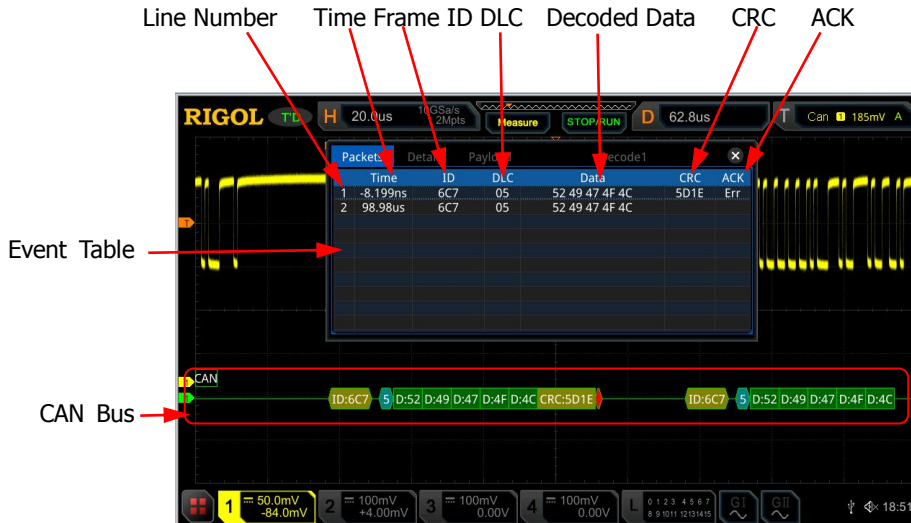





Figure 11-11 CAN Decoding Event Table

**Note:**

- When you adjust the horizontal time base, the waveform displayed on the screen will also change, and the total number of lines containing the decoding information in the event table will also be changed.
  - The displayed decoded data information in the bus is related to the value of the horizontal time base. Reducing the horizontal time base can help you view the detailed information.
- Set the event table format: Press **Format**, rotate the multifunction knob  to select the display format of "Data" in the event table. Then, press down the knob to select it. You can also press **Format** continuously or enable the touch screen to select it. The available formats include "Hex", "Dec", "Bin", and "ASC".
- Set the view type: Press **View**, then rotate the multifunction knob  to select the form of the event table to be viewed. Press down the knob to select it. You can also press **View** continuously or enable the touch screen to select it. The available choices include "Packets", "Details", and "Payload". You can also tap "Packets", "Details", or "Payload" at the top of the event table to select it.
- If you select "Packets", the decoded data, time, and other information are displayed in the event table. If you select "Details", the detailed data in the specified row will be displayed in the event table. If "..." appears in the row of data, it indicates that the decoded data are not fully displayed. At this time, you can view the details in the "Packets" view. If you select "Payload", all data in the specified column will be displayed in the event table. If "..." appears in the specified column of data, it indicates that the decoded data are not fully displayed. At this

- time, you can view the details in the "Packets" view.
- Export: If you select "Packets", you can export time and the corresponding decoded data. Press **Export**, the save setting menu is displayed. You can export the data table of the packets to the internal or external USB storage device (when detected) in CSV format. For detailed saving operation, refer to descriptions in **"Store and Load"**.
  - Jump to: Set the operating status of the oscilloscope to "STOP". Then, select the data of the specified time from the event table. Press **Jump to** and the specified data waveforms are displayed in the center of the screen.
  - Decode: The setting of this menu enables you to quickly view the corresponding event tables of four decode modules (Decode1, Decode2, Decode3, and Decode4). Press **Decode** and rotate the multifunction knob  to select a decode module, then press down the knob to select it. You can also press **Decode** continuously or enable the touch screen to select it.

## 6. Interpret the decoded CAN data

- Frame ID: expressed in Hex, displayed as a dark yellow-green patch.
- DLC (Data Length Code): expressed in Hex, displayed as a blue-green patch.
- Data: its display format is the same as that of the bus data (Hex, Dec, Bin, or ASCII), displayed as a green patch.
- CRC (Cyclic Redundancy Check): expressed in Hex, displayed in yellow-green. When errors occur, it is displayed as a red patch.
- ACK (Acknowledgement): when effective, displayed as a light yellow-green patch; when errors (ACK is detected to be 1) occur, displayed as a red patch.

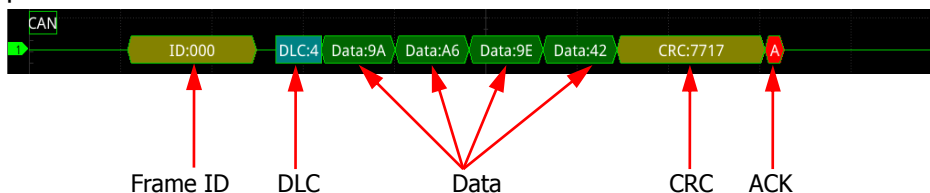

- R (remote frame): displayed as a tangerine patch.



## FlexRay Decoding (Option)

FlexRay is a type of differential serial bus configured with three consecutive segments (i.g. header, payload, and trailer). The oscilloscope samples the FlexRay signal at the specified sample position and judges each data point as logic "1" or logic "0" according to the preset threshold level. The FlexRay decoding is required to specify the signal type and baud rate.

In the decode setting menu, press **Decode1** → **Bus Type**, then rotate the multifunction knob  to select "FlexRay". Press down the knob to select it. You can also press **Bus Type** continuously or enable the touch screen to select it.



### 1. Enable or disable the bus

Press **Bus Status** continuously to enable or disable the decoding function.

### 2. Quickly apply FlexRay trigger settings to FlexRay decoding

Press **Copy Trig** to copy the FlexRay trigger settings and apply them to FlexRay decoding function (set the corresponding FlexRay decoding parameters automatically). For analog channels, the threshold level settings will also be copied.

### 3. Set the source and the threshold

- Press **Source** and rotate the multifunction knob  to select the desired source channel, and then press down the knob to select it. You can also press **Source** continuously or enable the touch screen to select it. The available channels include CH1-CH4 and D0-D15.
- When you select the analog channel (CH1-CH4), press **Threshold**, then rotate the multifunction knob  or use the pop-up numeric keypad to set the threshold of the source channel. When you modify the threshold of the channel, a dotted line displaying the current threshold level is displayed on the screen. The dotted line disappears in about 2 s after you stop modifying the threshold.

### 4. Signal setting

Press **Settings** to enter the signal setting menu.

#### ● Channel selection

Press **Channel** continuously to select a channel ("A" or "B") that matches the actual FlexRay bus signal.

#### ● Specify the signal rate

Press **Baud** to open the baud rate list (2.5 Mbps, 5 Mbps, and 10 Mbps), and select a preset baud rate that matches the actual FlexRay bus signal. You can also press **Baud** continuously, then rotate the multifunction knob  at a small step value or use the pop-up numeric keypad to set the

desired baud rate.

- **Set the signal type**

Press **Signal** and rotate the multifunction knob  to select a signal type that matches the actual FlexRay bus signal. Press down the knob to select it. You can also press **Signal** continuously or enable the touch screen to select it. The available signal types include BP, BM, and RX/TX.

- **Sample Position:**

Sample position is a point within a bit's time. The oscilloscope samples the bit level at this point. The sample position is represented by the proportion of "the time from the start of the bit to the sample position" to the "bit time", as shown in the figure below.

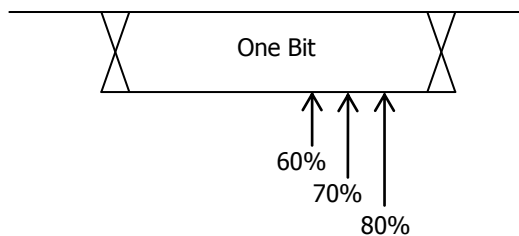



Figure 11-12 Sample Position

Press **Sample Position**, then rotate the multifunction knob  or use the pop-up numeric keypad to set the sample position. The settable range is from 10% to 90%.

## 5. Display-related setting

Press **Display** to enter the display setting menu.

- **Set the display format**

Press **Format**, rotate the multifunction knob  to select the display format of the bus data. Then, press down the knob to select it. You can also press **Format** continuously or enable the touch screen to select it. The available display formats of the bus data are "Hex", "Dec", "Bin", and "ASCII".

- **Adjust the vertical position of the bus**

Press **Position**, and then rotate the multifunction knob  to adjust the vertical display position of the bus.



- **Set the label display**

Press **Label** to enable or disable the label display of the FlexRay decoding bus. When enabled, the bus label "FlexRay" will be displayed at the upper-left side of the bus (when the bus display is enabled).



- **Event table**

Press **Event Table** to enter the event table setting menu. The event table displays the detailed decoding information in time order in the form of a table, so as to better observe the long decoded data. The decoding information includes the decoded data, the corresponding line number, time, frame ID, and Payload Length (PL).

- Open or close the event table: Press **Event Table** continuously to enable or disable the event table. When you enable the event table, the following figure is displayed, as shown in Figure 11-13. You can also enable the touch screen to tap the icon  at the upper-right corner of the table to close the event table. Besides, when the operating status is "STOP", you can also rotate the multifunction knob  to select a specified line and view the corresponding decoding information.

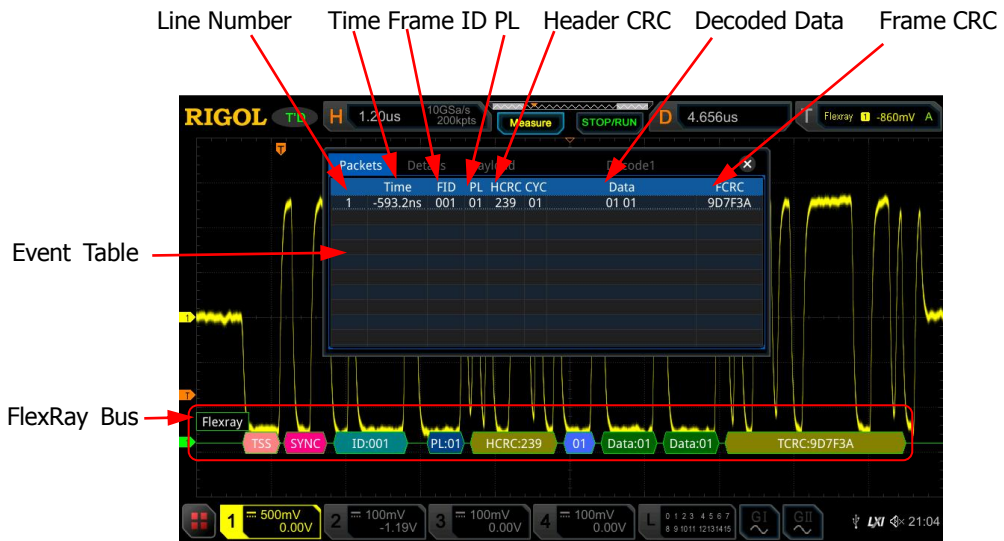





Figure 11-13 FlexRay Decoding Event Table

**Note:**

- When you adjust the horizontal time base, the waveform displayed on the screen will also change, and the total number of lines containing the decoding information in the event table will also be changed.
  - The displayed decoded data information in the bus is related to the value of the horizontal time base. Reducing the horizontal time base can help you view the detailed information.
- Set the event table format: Press **Format**, rotate the multifunction knob  to select the display format of "Data" in the event table. Then, press down the knob to select it. You can also press **Format** continuously or enable the touch screen to select it. The available

- formats include "Hex", "Dec", "Bin", and "ASC".
- Set the view type: Press **View**, then rotate the multifunction knob  to select the form of the event table to be viewed. Press down the knob to select it. You can also press **View** continuously or enable the touch screen to select it. The available choices include "Packets", "Details", and "Payload". You can also tap "Packets", "Details", or "Payload" at the top of the event table to select it. If you select "Packets", the decoded data, time, and other information are displayed in the event table. If you select "Details", the detailed data in the specified row will be displayed in the event table. If "..." appears in the row of data, it indicates that the decoded data are not fully displayed. At this time, you can view the details in the "Packets" view. If you select "Payload", all data in the specified column will be displayed in the event table. If "..." appears in the specified column of data, it indicates that the decoded data are not fully displayed. At this time, you can view the details in the "Packets" view.
  - Export: If you select "Packets", you can export time and the corresponding decoded data. Press **Export**, the save setting menu is displayed. You can export the data table of the packets to the internal or external USB storage device (when detected) in CSV format. For detailed saving operation, refer to descriptions in **"Store and Load"**.
  - Jump to: Set the operating status of the oscilloscope to "STOP". Then, select the data of the specified time from the event table. Press **Jump to** and the specified data waveforms are displayed in the center of the screen.
  - Decode: The setting of this menu enables you to quickly view the corresponding event tables of four decode modules (Decode1, Decode2, Decode3, and Decode4). Press **Decode** and rotate the multifunction knob  to select a decode module, then press down the knob to select it. You can also press **Decode** continuously or enable the touch screen to select it.

## 6. Interpret the decoded FlexRay frame data

- TSS: transmission start sequence, displayed as a pink patch.
- Sync Frame: displayed as a pink patch.
- ID (Frame ID): expressed in Hex, displayed as a blue-green patch.
- PL (Payload Length): expressed in Hex, displayed as a dark blue patch.
- HCRC (Header Cyclic Redundancy Check): expressed in Hex, displayed as a yellow-green patch. When CRC error occurs, it is displayed as a red patch.
- CYC (Cycle Number): expressed in Hex, displayed as a light blue patch.
- Data: Its display format is the same as that of the bus data (Hex, Dec, Bin, or ASCII), displayed as a green patch.
- TCRC (Tail Cyclic Redundancy Check): expressed in Hex, displayed as a yellow-green patch. When CRC errors occur, it is displayed as a red patch.

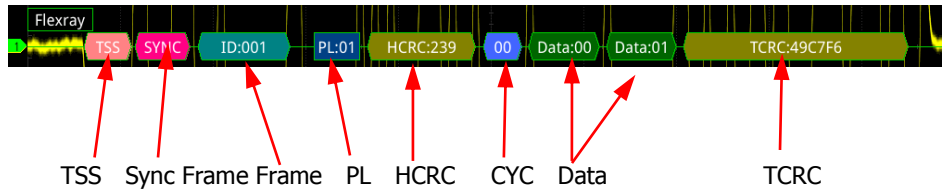

## I2S Decoding (Option)

The oscilloscope samples the I2S signal and judges each data point as logic "1" or logic "0" according to the preset threshold level. I2S decoding is required to specify the serial clock, channel signal, and the data's source channel. You need to set Alignment, WS Low, and other parameters. This decoding is only available for the MSO5XX4 model or the model installed with the MSO5000-4CH option.

In the decode setting menu, press **Decode1** → **Bus Type**, then rotate the multifunction knob  to select "I2S". Press down the knob to select it. You can also press **Bus Type** continuously or enable the touch screen to select it.

### 1. Enable or disable the bus

Press **Bus Status** continuously to enable or disable the decoding function.



### 2. Quickly apply I2S trigger settings to I2S decoding

Press **Copy Trig** to copy the I2S trigger settings and apply them to I2S decoding function (set the corresponding I2S decoding parameters automatically). For analog channels, the threshold level settings will also be copied.





### 3. Source setting

Press **Sources** to enter the source setting menu.

- **Set the serial clock channel source, threshold, and clock edge**

- Press **SCLK** and rotate the multifunction knob  to select the desired channel, and then press down the knob to select it. You can also press **SCLK** continuously or enable the touch screen to select it. The available channels include CH1-CH4 and D0-D15.
- When you select the analog channel (CH1-CH4), press **SCLK Thre** below **SCLK**, then rotate the multifunction knob  or use the pop-up numeric keypad to set the threshold of the SCLK. When you modify the threshold of the clock channel, a dotted line displaying the current threshold level is displayed on the screen. The dotted line disappears in about 2 s after you stop modifying the threshold.
- Press **SCLK Edge** continuously to select "Rising()" or

"Falling()" as the desired clock edge.

- **Set the WS source and the threshold**
  - Press **WS** and rotate the multifunction knob  to select the desired channel, and then press down the knob to select it. You can also press **WS** continuously or enable the touch screen to select it. The available channels include CH1-CH4 and D0-D15.
  - When you select the analog channel (CH1-CH4), press **WS Thre** below **WS**, then rotate the multifunction knob  or use the pop-up numeric keypad to set the threshold of the WS signal. When you modify the WS threshold, a dotted line displaying the current threshold level is displayed on the screen. The dotted line disappears in about 2 s after you stop modifying the threshold.
- **Set the data channel source and the threshold**
  - Press **Data** and rotate the multifunction knob  to select the desired data channel source, and then press down the knob to select it. You can also press **Data** continuously or enable the touch screen to select it. The available channels include CH1-CH4 and D0-D15.
  - When you select the analog channel (CH1-CH4), press **Data Thre** below **Data**, then rotate the multifunction knob  or use the pop-up numeric keypad to set the threshold of the data signal. When you modify the threshold of the data signal, a dotted line displaying the current threshold level is displayed on the screen. The dotted line disappears in about 2 s after you stop modifying the threshold.

#### 4. Bus Setting

Press **Settings** to enter the bus setting menu.

- **Set the word size**

Press **Word Size**, then rotate the multifunction knob  or use the pop-up numeric keypad to set the word size. Its range is from 4 to 32.
- **Set the receiver word size**

Press **Receive**, then rotate the multifunction knob  or use the pop-up numeric keypad to set the receiver word size. Its range is from 4 to 32.
- **Alignment**



Press **Alignment** and rotate the multifunction knob  to select the alignment way for data signal. Then press down the knob to select it. You can also press **Alignment** continuously or enable the touch screen to select it. The available alignment ways include I2S, LJ, and RJ.
- **Set the WS Low**

Press **WS Low** continuously to select "Left" or "Right".

- **Endian**

Press **Endian** to select "LSB" or "MSB". By default, it is "LSB".

- **Polarity setting**

Press **Data Polarity** continuously to select Positive  or Negative  as the polarity for data decoding.

## 5. Display-related setting

Press **Display** to enter the display setting menu.

- **Set the display format**

Press **Format**, rotate the multifunction knob  to select the display format of the bus data. Then, press down the knob to select it. You can also press **Format** continuously or enable the touch screen to select it. The available display formats of the bus data are "Hex", "Dec", "Bin", and "ASCII".

- **Adjust the vertical position of the bus**



Press **Position**, and then rotate the multifunction knob  to adjust the vertical display position of the bus.

- **Set the label display**

Press **Label** to enable or disable the label display of the I2S decoding bus. When enabled, the bus label "I2S" will be displayed at the upper-left side of the bus (when the bus display is enabled).

- **Event table**

Press **Event Table** to enter the event table setting menu. The event table displays the detailed decoding information in time order in the form of a table, so as to better observe the long decoded data. The decoding information includes the decoded left channel data, right channel data, the corresponding line number, and time.

- Open or close the event table: Press **Event Table** continuously to enable or disable the event table. When you enable the event table, the following figure is displayed, as shown in Figure 11-14. You can also enable the touch screen to tap the icon  at the upper-right corner of the table to close the event table. Besides, when the operating status is "STOP", you can also rotate the multifunction knob  to select a specified line and view the corresponding decoding information.

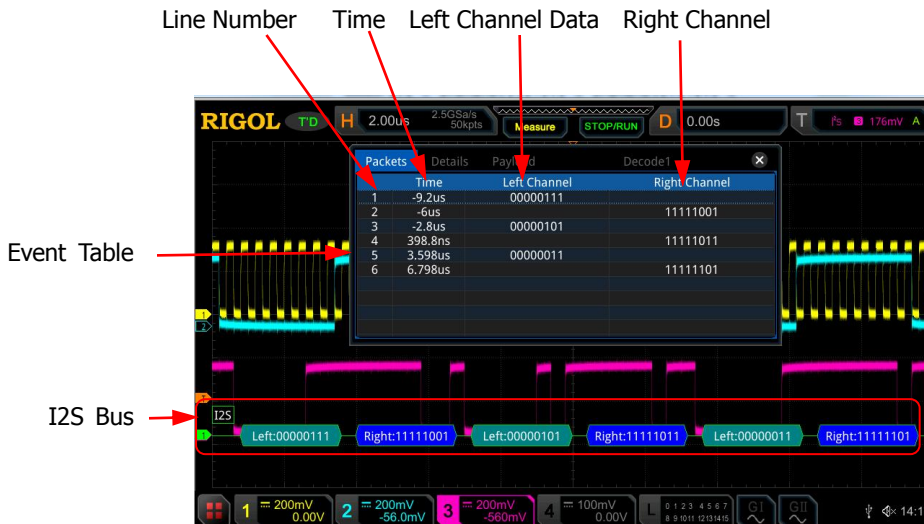





Figure 11-14 I2S Decoding Event Table

**Note:**

- When you adjust the horizontal time base, the waveform displayed on the screen will also change, and the total number of lines containing the decoding information in the event table will also be changed.
  - The displayed decoded data information in the bus is related to the value of the horizontal time base. Reducing the horizontal time base can help you view the detailed information.
- Set the event table format: Press **Format**, rotate the multifunction knob  to select the display format of "Data" in the event table. Then, press down the knob to select it. You can also press **Format** continuously or enable the touch screen to select it. The available formats include "Hex", "Dec", "Bin", and "ASC".
  - Set the view type: Press **View**, then rotate the multifunction knob  to select the form of the event table to be viewed. Press down the knob to select it. You can also press **View** continuously or enable the touch screen to select it. The available choices include "Packets", "Details", and "Payload". You can also tap "Packets", "Details", or "Payload" at the top of the event table to select it. If you select "Packets", the decoded data, time, and other information are displayed in the event table. If you select "Details", the detailed data in the specified row will be displayed in the event table. If "..." appears in the row of data, it indicates that the decoded data are not fully displayed. At this time, you can view the details in the "Packets" view. If you select "Payload", all data in the specified column will be

displayed in the event table. If "..." appears in the specified column of data, it indicates that the decoded data are not fully displayed. At this time, you can view the details in the "Packets" view.

- **Export:** If you select "Packets", you can export time and the corresponding decoded data. Press **Export**, the save setting menu is displayed. You can export the data table of the packets to the internal or external USB storage device (when detected) in CSV format. For detailed saving operation, refer to descriptions in "**Store and Load**".
- **Jump to:** Set the operating status of the oscilloscope to "STOP". Then, select the data of the specified time from the event table. Press **Jump to** and the specified data waveforms are displayed in the center of the screen.
- **Decode:** The setting of this menu enables you to quickly view the corresponding event tables of four decode modules (Decode1, Decode2, Decode3, and Decode4). Press **Decode** and rotate the multifunction knob  to select a decode module, then press down the knob to select it. You can also press **Decode** continuously or enable the touch screen to select it.

## 1553B Decoding (Option)

The oscilloscope samples the 1553B signal, and judges each data point to be logic "1" or logic "0" according to the preset threshold level. 1553B decoding is required to specify the data channel source and the threshold.

In the decode setting menu, press **Decode1** → **Bus Type**, then rotate the multifunction knob  to select "1553B". Press down the knob to select it. You can also press **Bus Type** continuously or enable the touch screen to select it.



### 1. Enable or disable the bus

Press **Bus Status** continuously to enable or disable the decoding function.

### 2. Quickly apply 1553B trigger settings to 1553B decoding

Press **Copy Trig** to copy the 1553B trigger settings and apply them to 1553B decoding function (set the corresponding I2S decoding parameters automatically).

### 3. Set the data channel source and the threshold

- Press **Data** and rotate the multifunction knob  to select the desired data channel source, and then press down the knob to select it. You can also press **Data** continuously or enable the touch screen to select it. The available channels include CH1-CH4.
- Press **Threshold**, then rotate the multifunction knob  or use the pop-up numeric keypad to set the threshold of the source channel. When you modify the threshold of the channel, a dotted line displaying the current

threshold level is displayed on the screen. The dotted line disappears in about 2 s after you stop modifying the threshold.

#### 4. Display-related setting

Press **Display** to enter the display setting menu.

- **Set the display format**

Press **Format**, rotate the multifunction knob  to select the display format of the bus data. Then, press down the knob to select it. You can also press **Format** continuously or enable the touch screen to select it. The available display formats of the bus data are "Hex", "Dec", "Bin", and "ASCII".

- **Adjust the vertical position of the bus**



Press **Position**, and then rotate the multifunction knob  to adjust the vertical display position of the bus.

- **Set the label display**

Press **Label** to enable or disable the label display of the 1553B decoding bus. When enabled, the bus label "1553B" will be displayed at the upper-left side of the bus (when the bus display is enabled).

- **Event table**

Press **Event Table** to enter the event table setting menu. The event table displays the detailed decoding information in time order in the form of a table, so as to better observe the long decoded data. The decoding information includes the decoded data, word type, the corresponding line number, time, and error information.

- Open or close the event table: Press **Event Table** continuously to enable or disable the event table. When you enable the event table, the following figure is displayed, as shown in Figure 11-15. You can also enable the touch screen to tap the icon  at the upper-right corner of the table to close the event table. Besides, when the operating status is "STOP", you can also rotate the multifunction knob  to select a specified line and view the corresponding decoding information.



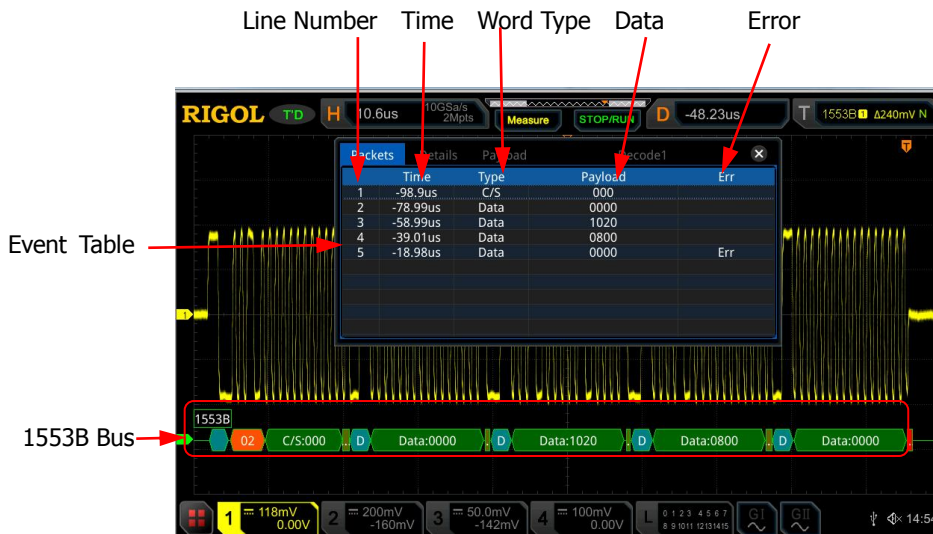





Figure 11-15 1553B Decoding Event Table

**Note:**

- When you adjust the horizontal time base, the waveform displayed on the screen will also change, and the total number of lines containing the decoding information in the event table will also be changed.
  - The displayed decoded data information in the bus is related to the value of the horizontal time base. Reducing the horizontal time base can help you view the detailed information.
- Set the event table format: Press **Format**, rotate the multifunction knob  to select the display format of "Data" in the event table. Then, press down the knob to select it. You can also press **Format** continuously or enable the touch screen to select it. The available formats include "Hex", "Dec", "Bin", and "ASC".
- Set the view type: Press **View**, then rotate the multifunction knob  to select the form of the event table to be viewed. Press down the knob to select it. You can also press **View** continuously or enable the touch screen to select it. The available choices include "Packets", "Details", and "Payload". You can also tap "Packets", "Details", or "Payload" at the top of the event table to select it.
- If you select "Packets", the decoded data, time, and other information are displayed in the event table. If you select "Details", the detailed data in the specified row will be displayed in the event table. If "..." appears in the row of data, it indicates that the decoded data are not fully displayed. At this time, you can view the details in the "Packets" view. If you select "Payload", all data in the specified column will be displayed in the event table. If "..." appears in the specified column of

data, it indicates that the decoded data are not fully displayed. At this time, you can view the details in the "Packets" view.

- Export: If you select "Packets", you can export time and the corresponding decoded data. Press **Export**, the save setting menu is displayed. You can export the data table of the packets to the internal or external USB storage device (when detected) in CSV format. For detailed saving operation, refer to descriptions in **"Store and Load"**.
- Jump to: Set the operating status of the oscilloscope to "STOP". Then, select the data of the specified time from the event table. Press **Jump to** and the specified data waveforms are displayed in the center of the screen.
- Decode: The setting of this menu enables you to quickly view the corresponding event tables of four decode modules (Decode1, Decode2, Decode3, and Decode4). Press **Decode** and rotate the multifunction knob  to select a decode module, then press down the knob to select it. You can also press **Decode** continuously or enable the touch screen to select it.

### 5. Interpret the decoded 1553B data

- C/S: command/status word. It is displayed as a blue-green patch.
- RTA: remote terminal address of the command/status word. It is displayed as a tangerine patch.
- C/S data: the rest data value of the command/status word. Its display format is the same as that of the bus data (Hex, Dec, Bin, or ASCII), displayed as a green patch.
- Parity bit: displayed as a yellow-green patch; when errors occur, displayed as a red patch.
- Data word data: data of the data word. Its display format is the same as that of the bus data (Hex, Dec, Bin, or ASCII), displayed as a green patch.

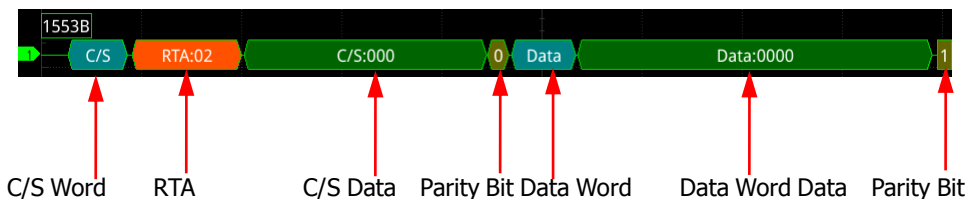

## Chapter 12 Reference Waveform

MSO5000 series oscilloscope provides 10 reference waveform positions (Ref1-Ref10). In the actual test process, you can compare the signal waveform with the reference waveform to locate the failure.

Contents in this chapter:

- To Enable Ref Function
- To Select the Reference Channel
- To Select the Ref Source
- To Adjust the Ref Waveform Display
- To Save to Internal Memory
- To Clear the Display of the Reference Waveform
- To View Details of the Reference Waveform
- To Reset the Reference Waveform
- Color Setting
- Label Setting
- To Export to Internal or External Memory
- To Import from Internal or External Memory

## To Enable Ref Function

Press **Ref** on the front panel to enable the reference waveform function, or enable the touch screen and then tap the function navigation icon  at the lower-left corner of the screen to open the function navigation. Then, tap the "Ref" icon to enable the reference waveform function.

When the Ref function is enabled, you can select a different color for each reference waveform, set the source of each reference channel, adjust the vertical scale and offset of the reference waveform, save the reference waveform to the internal or external memory, and recall it when needed.

**Note:** When the horizontal time base is set to XY, the reference waveform function is disabled.

## To Select the Reference Channel

Press **Current**, rotate the multifunction knob  to select the desired reference waveform channel (Ref1-Ref10). You can also press **Current** continuously or enable the touch screen to select the reference waveform channel. By default, Ref1 is enabled.

## To Select the Ref Source

Press **Source**, rotate the multifunction knob  to select the desired reference waveform source (CH1-CH4, D0-D15, or Math1-Math4). You can also press **Source** continuously or enable the touch screen to select the reference waveform source.

**Note:** Only the currently enabled channel can be selected as the source channel of the reference waveform.

## To Adjust the Ref Waveform Display

After pressing **SaveToRef**, you can adjust the vertical scale and offset of the reference waveform specified under **Current**.

- Press **VScale**, then rotate the multifunction knob  or use the pop-up numeric keypad to set the vertical scale of the reference waveform. You can also enable the touch screen and use the "Pinch & Stretch" gesture to adjust the vertical scale.

- Press **VOffset**, then rotate the multifunction knob  or use the pop-up numeric keypad to set the vertical offset of the reference waveform. You can also enable the touch screen and use the "Drag" gesture to adjust the vertical offset.

## To Save to Internal Memory

Press **SaveToRef** to save the displayed waveform for the specified source to the internal memory as the reference waveform.

**Note:** This operation only saves the reference waveform to the volatile memory, and the waveform will be cleared at power-off.

## To Clear the Display of the Reference Waveform

Press **Clear** to clear the display of the current reference waveform on the screen. Meanwhile, the **VScale** and **VOffset** menus for the reference waveform are grayed out and disabled. You can also press **CLEAR** on the front panel to clear the display of the reference waveforms of all the reference channels.

**Note:** This operation only clears the display of the reference waveform on the screen, and the reference waveform is still saved in the memory.

## To View Details of the Reference Waveform

Press **More** → **Details**, and the detailed information about all the reference waveforms will be displayed on the screen in the form of a list. Press **Details** again to close the details list. You can also enable the touch screen to tap the icon  at the right-upper corner of the table to close it.



REF	Status	SaRate	Scale	Offset
REF1	ON	2.5GSa/s	200mV	32mV
REF2	OFF	2.5GSa/s	200mV	32mV
REF3	OFF	0Sa/s	1V	0V
REF4	OFF	0Sa/s	1V	0V
REF5	OFF	0Sa/s	1V	0V
REF6	OFF	0Sa/s	1V	0V
REF7	OFF	0Sa/s	1V	0V
REF8	OFF	0Sa/s	1V	0V
REF9	OFF	0Sa/s	1V	0V
REF10	OFF	0Sa/s	1V	0V

## To Reset the Reference Waveform

Press **More** → **Reset**, and the reference waveform is restored to the position where the source channel waveform is located when the **SaveToRef** operation was executed.

## Color Setting

MSO5000 series oscilloscope provides five colors (gray, green, blue, red, and orange) to mark the reference waveforms of different channels in order to distinguish the reference waveforms of different reference waveform channels.

Press **Color**, and then rotate the multifunction knob  to select the color of the reference waveform of the channel. You can also press **Color** continuously or enable the touch screen to select it. The GND icon and the label at the left side of the waveform of the currently selected channel will be filled with the specified color. For example,  and .

## Label Setting

Press **More** → **Label** to enter the label setting menu. You can use the built-in label in the library or manually input a label. Three input methods are available for you to input a label name, including Chinese, English, and Traditional Chinese.

- Press **Display** continuously to enable or disable the display of the reference waveform label. If it is enabled, the label will be displayed at the left side of the waveform. If the current channel is REF $n$  ( $n=1,2, \dots,10$ ), then the default label of the reference waveform is REF $n$  ( $n=1, 2, \dots,10$ ).
- Press **Library** and rotate the multifunction knob  to select the preset label, and then press down the knob to select it. You can also press **Library** continuously or enable the touch screen to select it. The available preset labels include Default, ACK, ADDR, BIT, CLK, and etc.
- Press **Label**, and the label editing interface is automatically displayed. You can input the label manually. For the label editing methods, refer to descriptions in "**Channel Label**".

## To Export to Internal or External Memory

You can also save the current reference waveform to the internal memory or external USB storage device. The file format of the reference waveform is ".ref", ".bin", or ".csv".

Press **More** → **Export** to enter the reference waveform file saving interface. Please refer to descriptions in "**Store and Load**" to save the reference waveform to the internal or external memory. Only when the reference waveform is saved, can this export function is valid.

**Note:** MSO5000 series oscilloscope only supports the flash memory USB storage device of FAT32 format.

## To Import from Internal or External Memory

You can also import the stored reference waveform file from the internal memory or external USB storage device to the instrument and display the file on the screen.

Press **More** → **Import** to enter the reference waveform file loading interface. Please refer to descriptions in "**Store and Load**" to import the reference waveform to the instrument and display it on the screen.

**Note:** MSO5000 series oscilloscope only supports the flash memory USB storage device of FAT32 format.





## Chapter 13 Pass/Fail Test

During the product design and manufacturing process, you usually need to monitor the variations of the signal or judge whether the product is up to standard. The pass/fail test function of MSO5000 series oscilloscope can accomplish this task perfectly.

Contents in this chapter:

- To Enable or Disable the Pass/Fail Test
- To Start or Stop the Pass/Fail Test Operation
- To Select the Source
- To Create a Mask
- To Save the Mask
- To Load a Mask
- To Set the Output Form of the Test Results
- To Enable or Disable the Display of the Statistics of the Test Results
- Statistics Reset

## To Enable or Disable the Pass/Fail Test Function

Press **Utility** → **PassFail** to open the pass/fail test setting menu, or enable the touch screen and then tap the function navigation icon  at the lower-left corner of the screen to open the function navigation. Then, tap the "Pass/Fail" icon to open the pass/fail test setting menu.

In the menu, press **Enable** continuously to enable or disable the pass/fail test function.

**Note:** The pass/fail test function cannot be enabled in the following conditions: when the time base mode is "XY" or "ROLL"; when the delay sweep is enabled.

## To Start or Stop the Pass/Fail Test Operation

After the Pass/Fail test function is enabled, press **Operate** continuously to start or stop the test operation.

During the test process, the oscilloscope will test the waveforms, display the test information, and output the test failure information based on the current settings. You can set the test mask, the display status of the test information, and the output form of a failed test based on the selected source channel for the test. Then save the test mask range to the internal or external memory, and then recall it when needed. For the details, please refer to the following section.

### Note:

- Only when the pass/fail test function is enabled, can you start or stop the pass/fail test operation, enable or disable the display of the test information, save and recall the test mask range.
- After starting the test operation, you can neither modify the source channel nor adjust the test mask.



## To Select the Source

Before selecting the source, connect the signal under test to the analog channel input terminal of the oscilloscope. Press **Source** and rotate the multifunction knob  to select the desired source channel, and then press down the knob to select it. You can also press **Source** continuously or enable the touch screen to select it. The available source channels include the analog channel (CH1-CH4).

**Note:** Only the channels that have been enabled currently can be selected.

## To Create a Mask

Press **Mask** → **Create** to self-define the mask of the pass/fail test. Press **Range** and rotate the multifunction knob  to select the mask range. Press down the knob to select it. You can also press **Range** continuously or enable the touch screen to select it. You can select "Screen" or "Cursor" as the mask region. The default is "Screen".

- If "Screen" is selected under **Range**, then the whole waveform display area is considered to be the mask region. Press **X Mask** and **Y Mask** respectively. Rotate the multifunction knob  at a small step or use the pop-up numeric keypad to adjust the horizontal tolerance range and vertical tolerance range of the test mask. During the adjustment, two white curves would be displayed in the interface to show the outline of the current mask. Press **Create** to apply the currently created mask (the region not covered by blue within the screen).
- When "Cursor" is selected, two cursors (used to specify the current test mask range) will be displayed on the screen. Cursor A is at the left and Cursor B is at the right. Press **CursorA** and **CursorB**, and rotate the multifunction knob  to adjust the positions of both Cursor A and Cursor B, respectively. Also you can press **CursorAB** and rotate the multifunction knob  to adjust the two cursors synchronously (the spacing between Cursor A and Cursor B remains unchanged). Then, refer to the above methods to adjust the horizontal and vertical tolerance ranges, as well as create a mask (the region not covered by blue within the cursor region).

## To Save the Mask

When the pass/fail test function is enabled, you can save the current test mask range to the internal memory or external USB storage device (when detected) in "\*.pf" format.

Press **Mask** → **Save** to enter the file saving interface. Please refer to descriptions in "**Store and Load**" to save the test mask file to the internal or external memory.

## To Load a Mask

When the pass/fail test function is enabled, you can load the test mask files from the internal memory or external USB storage device (when detected) and apply them to the current pass/fail test function.

Press **Mask** → **Load** to enter the file loading interface. Please refer to descriptions in "**Store and Load**" to load the specified test mask files (in \*.pf format) and apply

them to the current pass/fail test function.

## To Set the Output Form of the Test Results

Press **Option** to enter the "Option" menu. You can set what the oscilloscope will execute when test results are detected according to your needs.



### ● Set the output event and Aux output

- Press **Output Event**, and rotate the multifunction knob  to select "Fail" or "Pass". Press down the knob to select it. You can also press **Output Event** continuously to enable the touch screen to select it.
- Press **Aux Output** continuously to enable or disable the Aux output. If enabled, press **Utility** → **System**, and then the **AUX Out** is automatically set to "PassFail". When a successful or failed event is detected, a pulse will be output from the rear-panel **[TRIG OUT]** connector. If the Aux output is disabled, press **Utility** → **System**, and then the **AUX Out** is automatically set to "TrigOut". The output of the rear-panel **[TRIG OUT]** connector is irrelevant with the pass/fail test.

### ● Set the output polarity and output pulse width

Press **Polarity** continuously to select "Positive" or "Negative". Then press **Pulse**, rotate the multifunction knob  or use the pop-up numeric keypad to set the pulse width. Its range is from 100 ns to 10 ms. By default, it is 1 μs.

### ● Set the error action

Press **Err Action**, and rotate the multifunction knob  to set the operation that the oscilloscope will execute once a failed test is detected. Press down the knob to select it. You can also press **Err Action** continuously and press down the multifunction knob  to select it. Also, you can enable the touch screen to select it.

- **Stop:** indicates stopping test when a pass/fail test event is found.
- **Beeper:** indicates that the beeper sounds an alarm when a pass/fail test event is found (irrelevant with the on/off status of the beeper).
- **Screenshot:** performs the screenshot operation when a pass/fail test event is found. If an external storage device is detected, the screenshot will be saved to the external storage device directly. Otherwise, it will be saved to the local disk.

**Note:** If "Screenshot" is selected under **Err Action**, "Stop" action will be executed automatically. The test will be stopped forcibly.

## To Enable or Disable the Display of the Statistics of the Test Results

Press **Information** continuously to enable or disable the display of the statistics of the test results. You can also enable the touch screen to tap the icon  at the right-upper corner of the statistics window to close it.

The test results statistics include the number of failed frames, the number of successful frames, and total number of frames, as shown in the figure below.

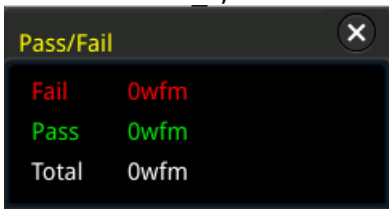
A screenshot of a statistics window titled "Pass/Fail" with a close button (X) in the top right corner. The window displays three rows of data: "Fail" with a value of "0wfm", "Pass" with a value of "0wfm", and "Total" with a value of "0wfm".

Pass/Fail	
Fail	0wfm
Pass	0wfm
Total	0wfm

## Statistics Reset

Press **Reset** to clear the current test results and execute statistics on the test results again.



## Chapter 14 Waveform Recording & Playing

Waveform recording & playing function can play the recorded waveforms of the analog input channels (CH1-CH4) and the digital channels (D0-D15), enabling you to analyze the waveforms better.

**Note:** The horizontal time base must be set to "YT" mode during waveform recording.

Contents in this chapter:

- Common Settings
- Record Options
- Play Options

## Common Settings

Press **Utility** → **Record** to enter the waveform recording function setting menu. You can also enable the touch screen and then tap the function navigation icon  at the lower-left corner of the screen to open the function navigation. Then, tap the "Record" icon to open the waveform recording function setting menu.

### 1. Waveform Recording

Press **Record** continuously to enable the waveform recording function. Before recording the waveform, you can refer to descriptions in "**Record Options**" to set the waveform recording parameters. Press **Record** to start recording the waveform. The record icon turns "□" from "○" automatically. During the recording, the current real-time recording information is displayed on the screen, as shown in Figure 14-1. In the figure, the data at the left side of the slash is the current frame. Its value changes constantly (the value under the **Current** menu is changing constantly too), and the data at the right of the slash indicate the number of frames for recording. The time difference  $\Delta T$  at the upper-right corner indicates the time different between the current frame and the first frame. After the recording is completed, "□" automatically turns out to be "○". The recording is stopped automatically. During the recording, you can also press **Record** again to stop recording manually. Also, you can enable the touch screen to tap the specified button to perform the recording operation.

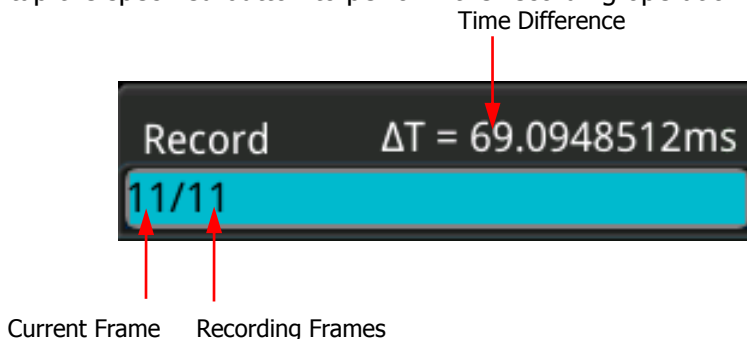



Figure 14-1 Recording Process Information

### 2. Play

Press **Playing** to start playing the recorded waveforms. "▶" automatically turns out to be "⏏". For details about playing, refer to descriptions in "**Play Options**". During the waveform recording, the current frame changes accordingly (the value of the parameter **Current** changes accordingly). After playing is completed, "⏏" automatically turns out to be "▶" automatically. During the playing process, you can also press **Playing** to stop playing manually.

### 3. Current Frame

Press **Current**, then rotate the multifunction knob  or use the pop-up numeric keypad to set the current frame. At this time, the waveform of the current frame is displayed on the screen.



#### 4. Set Transition

Press **Jump To** continuously to select to jump to the recorded end frame (Last) or the recorded start frame (First). For settings of the start and end frames, refer to descriptions in "**Play Options**".

## Record Options

During the waveform recording, the oscilloscope records the waveforms of the currently enabled channel at a specified interval until you manually stops the recording operation or the number of recorded frames has reached the set value.

**Note:** Before starting the recording operation, turn on the desired channel and adjust the waveform display to the desired state. When starting the recording operation, you can neither enable/disable the channel output nor adjust the waveform display.

Before recording the waveforms, you can press **More** → **Setting** to select "Record" to set the following parameters.

#### 1. Recording Interval

The recording interval indicates the time interval between the frames during the recording process.

Press **Interval**, then rotate the multifunction knob  or use the pop-up numeric keypad to set the time interval between frames. The available range is from 10 ns to 10 s.

#### 2. Recording Frames

The recording frames refer to the number of frames that can be recorded actually. After starting the recording operation, the oscilloscope stops the recording operation automatically when the number of recorded frames reaches the set value.

Press **Frames**, then rotate the multifunction knob  or use the pop-up numeric keypad to set the number of recorded frames. The available range is from 1 to the maximum number of frames that can be recorded currently (available in the **Max Frames** menu). Press **Set to Max** to set the number of recorded waveform frames to the maximum number of frames automatically.



#### 3. Max Frames

The menu shows the maximum number of frames that can be recorded currently. As the capacity of the waveform memory is fixed, the more the number of points each frame of waveform has, the less the number of waveform frames that can be recorded. Therefore, the maximum number of recorded frames is related to the currently selected "memory depth" (refer to "**Memory Depth**"). The current memory depth refers to the number of waveform points per frame.

Memory Depth = Sample Rate x Horizontal Time Base x Number of Grids in the Horizontal Direction. Therefore, the maximum number of frames of waveform recording is also related to the "Sample Rate" and "Horizontal Time Base". This oscilloscope provides ceaseless recording for a maximum of 450,000 frames of real-time waveforms.

#### 4. Beeper



Press **Beeper** continuously to set whether the beeper sounds when the recording is completed.



- : the beeper sounds at the end of recording.
- : the beeper does not sound at the end of recording.

## Play Options



Waveform playing function can play back the waveforms currently recorded. Before playing back the waveforms, you can press **More** → **Setting** to select "Play" to set the following parameters.



#### 1. Play Mode

Press **Mode** continuously to set the playback mode to  (cycle) or  (single).

- : plays from the start frame to the end frame, then such playback operation is repeated until you stop it manually.
- : plays from the start frame to the end frame, and then stops automatically.

#### 2. Playback Sequence

Press **Sequence** continuously to select the playback sequence to  (playback clockwise) or  (playback counterclockwise).

- : plays from the start frame to the end frame.
- : plays from the end frame to the start frame.

#### 3. Playback Interval

The playback interval indicates the time interval between the frames during the playing process.

Press **Interval**, then rotate the multifunction knob  or use pop-up numeric keypad to set the time interval between frames. The available range is from 10 ns to 10 s.

#### 4. Start Frame

Press **Start Frame**, then rotate the multifunction knob  or use the pop-up numeric keypad to set the start frame of playback. By default, it is 1, and the maximum value is the number of recorded frames.

## 5. End Frame

Press **End Frame**, then rotate the multifunction knob  or use the pop-up numeric keypad to set the end frame of playback. The default is the number of frames of the recorded waveforms.



# Chapter 15 Search and Navigation Function

The search function allows you to search for relevant events based on the search condition that you set. The navigation function includes the recording & playing navigation, time navigation, and event navigation.

Contents in this chapter:

- Search Function
- Navigation Function

## Search Function







The search function enables you to search the channel edge, Pulse trigger, Runt trigger, Slope trigger, RS232 trigger, I2C trigger, or SPI trigger. Press **Search** on the front panel to enable the search setting menu. You can also enable the touch screen and then tap the function navigation icon  at the lower-left corner of the screen to open the function navigation. Then, tap the "Search" icon to open the search setting menu.

### 1. Enable or Disable the Search Function

Press **Search** continuously to enable or disable the search function.

### 2. Select the Search Type and Set the Parameters

Press **Type**, and rotate the multifunction knob  to select the desired type (Edge, Pulse, Runt, Slope, RS232, I2C, or SPI). You can also press **Type** continuously or enable the touch screen to select it.

- **Edge:** Press **Type** to select "Edge" as the search type. For **Edge Set** menu settings, refer to descriptions in "**Edge Trigger**". Press **Threshold** to enter the threshold setting menu. Rotate the multifunction knob  or use the pop-up numeric keypad to set the threshold.
- **Pulse:** Press **Type** to select "Pulse" as the search type. For **Pulse Set** menu settings, refer to descriptions in "**Pulse Trigger**". Press **Threshold** to enter the threshold setting menu. Rotate the multifunction knob  or use the pop-up numeric keypad to set the threshold.
- **Runt:** Press **Type** to select "Runt" as the search type. For **Runt Set** menu settings, refer to descriptions in "**Runt Trigger**". Press **Threshold** to enter the threshold setting menu. Rotate the multifunction knob  or use the pop-up numeric keypad to set Threshold A and Threshold B.
- **Slope:** Press **Type** to select "Slope" as the search type. For **Slope Set** menu settings, refer to descriptions in "**Slope Trigger**". Press **Threshold** to enter the threshold setting menu. Rotate the multifunction knob  or use the pop-up numeric keypad to set Threshold A and Threshold B.
- **RS232:** Press **Type** to select "RS232" as the search type. For **RS232 Set** menu settings, refer to descriptions in "**RS232 Trigger (Option)**". Press **Threshold** to enter the threshold setting menu. Rotate the multifunction knob  or use the pop-up numeric keypad to set the threshold.
- **I2C:** Press **Type** to select "I2C" as the search type. For **I2C Set** menu settings, refer to descriptions in "**I2C Trigger (Option)**". Press **Threshold** to enter the threshold setting menu. Rotate the multifunction knob  or use the pop-up numeric keypad to set the thresholds of SCL

and SDA.

- **SPI:** Press **Type** to select "SPI" as the search type. For **SPI Set** menu settings, refer to descriptions in "**SPI Trigger (Option)**". Press **Threshold** to enter the threshold setting menu. Rotate the multifunction knob  or use the pop-up numeric keypad to set the thresholds of SCL, SDA, and CS.

### 3. Copy Trigger

- **Copy to Trigger**

Press **More** → **To Trigger** to copy the selected search type to the same trigger type. For example, if the current search type is "Edge", press **To Trigger** to copy the edge search settings to the "**Edge Trigger**" settings.

- **From Trigger**

Press **More** → **From Trigger** to copy from the trigger settings of the selected search type to the search settings. For example, if the current trigger type is "**Edge Trigger**", press **From Trigger** to copy from the Edge trigger settings to the "Edge" search settings.

**Note:** If you select "From Trigger", you need to set the search type first, and then copy the trigger type settings from the trigger menu.

### 4. Open or Close the Mark Table

Press **MarkTable** continuously to enable or disable the display of the mark table. The mark table is shown as below. You can also enable the touch screen to tap the icon  at the right-upper corner of the table to close it.

Total count : 10 		
Num	Time	Count
001	-4.09185ms	(1)
002	-3.09275ms	(1)
003	-2.09235ms	(1)
004	-1.09095ms	(1)
005	-91.0999us	(1)
006	908.400us	(1)
007	1.90890ms	(1)
008	2.90760ms	(1)
009	3.90785ms	(1)
010	4.90850ms	(1)

### 5. Navigation

Press **Navigation**, then rotate the multifunction knob  or use the pop-up numeric keypad to set the event No. to navigate the event. You can also use the navigation combination keys to make navigations at a step of 1. For details, refer

to descriptions in "**Navigation Function**".

## 6. Save

You can save the event mark data to the internal memory or external USB storage device in "\*.csv" format.

Press **More** → **Save** to enter the file saving interface. Please refer to descriptions in "**Store and Load**" to save the event mark data to the internal or external memory.



**Note:** MSO5000 only supports the flash memory USB storage device of FAT32 format.

## Navigation Function





The navigation function includes the recording & playing navigation, time navigation, and event navigation. In the horizontal control area (Horizontal) on the front panel, the navigation combination keys are shown as follows:



### ● Recording & Playing Navigation

When you enable the waveform recording function and complete the waveform recording operation, press the navigation combination keys to play the recorded waveforms. Press  to play the recorded waveforms in reverse order; press  to play the recorded waveforms in normal order; press  to stop playing.

### ● Time Navigation



After the data acquisition stops, use the navigation combination keys to play the captured data waveforms in a fast and continuous way. Press  to play the previous recorded waveforms; press  to play the next recorded waveforms; press  to stop playing. Besides, press  or  repeatedly can accelerate the playing of the waveforms, so that you can quickly locate the acquired data waveforms.

**Note:** The time navigation function is only available when the time base mode is "YT" and the instrument stays in "STOP" status.

### ● Event Navigation

When you enable the navigation function and complete the event search, you can use the navigation combination keys to quickly navigate the specific event in the event mark table. Press  to navigate to the previous event (the serial



number in the mark table decreases); press  to navigate to the next event (the serial number in the mark table increases); the  key is disabled in the event navigation.



## Chapter 16 Display Control

In the display control setting menu, you can set the parameters such as the waveform display type, persistence time, intensity, grid type, grid brightness, and etc.

Contents in this chapter:

- To Select the Display Type
- To Set the Persistence Time
- To Set the Waveform Intensity
- To Set the Screen Grid
- To Set the Grid Brightness
- Scale
- Color Grade
- Waveform Freeze
- Screen Saver

## To Select the Display Type

Press **Display** to enter the display control setting menu. Press **Type** continuously to set the waveform display mode to "Vector" or "Dots".

- Vector display: indicates that the sample points are connected by lines and displayed, as shown in the left figure below. In most cases, this mode can provide the most vivid waveform for you to view the steep edge of the waveform (such as square waveform).
- Dots display: displays the sample points directly, as shown in the right figure below. You can directly view each sample point and use the cursor to measure the X and Y values of the sample point.

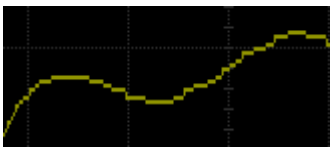

Vector Display

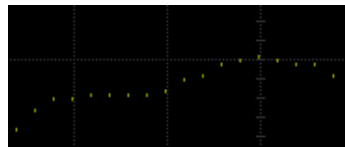

Dots Display

## To Set the Persistence Time

Press **Persis.Time**, and rotate the multifunction knob  to set the persistence time for the oscilloscope and then press down the knob to select it. You can also press **Persis.Time** continuously or enable the touch screen to select it. The available values are Min, 100 ms, 200 ms, 500 ms, 1 s, 2 s, 5 s, 10 s, and Infinite.

In the following part, a frequency sweep signal of the sine waveform is used to demonstrate the waveform effects in different persistence times.

### 1. Min

Enables to view waveform changing in high refresh rate.



### 2. Specific Values

Enables to view glitches that change relatively slowly or glitches with lower occurrence probability. The persistence time can be set to 100 ms, 200 ms, 500 ms, 1 s, 2 s, 5 s, or 10 s.

### 3. Infinite

In this mode, the oscilloscope displays the waveform newly acquired without clearing the waveforms acquired formerly. The waveforms acquired formerly will be displayed in relatively low-brightness color and the newly acquired waveforms will be displayed in normal brightness and color. Infinite persistence can be used to measure noise and jitter and to capture incidental events.

## To Set the Waveform Intensity

Press **Intensity**, then rotate the multifunction knob  at a small step value or use the pop-up numeric keypad to set the waveform intensity. Note that in the non-menu operation mode, you can also rotate the multifunction knob  to adjust the waveform brightness of the channel. The default is 60%, and the range available is from 1% to 100%.

## To Set the Screen Grid

Press **Grid**, and rotate the multifunction knob  to set the grid type and then press down the knob to select it. You can also press **Grid** continuously or enable the touch screen to select it. You can select "FULL", "HALF", "NONE", or "IRE".

- FULL: turns the background grid and coordinate on.
- HALF: turns the background grid off.
- NONE: turns the background grid and coordinate off.
- IRE: only available for testing the video signal (i.g. the trigger type is set to "Video" trigger, and the vertical scale is set to 140 mV).

When "IRE" is selected, the screen displays the vertical graticule in IRE and marks it at the left side of the screen. Its range is from -40 IRE to +100 IRE. Meanwhile, 0.35 V and 0.7 V levels are displayed at the right side of the screen, as shown in the following figure.



## To Set the Grid Brightness

Press **Brightness**, then rotate the multifunction knob  at a small step value or use the pop-up numeric keypad to set the grid intensity. The default is 20%, and the range available is from 1% to 100%.

## Scale

Press **Show Scale** continuously to enable or disable the scale display on the screen. By default, it is set to "OFF".

**Note:** When the digital channel is enabled, the scale in the vertical direction is hidden automatically.

## Color Grade



Press **More** → **Color Grade** to enable or disable the color grade display of the analog channel waveforms on the screen. By default, it is set to "OFF". When enabled, different colors are displayed on the screen to indicate the times of data acquisition or acquisition probability.

## Waveform Freeze

Press **More** → **Waveform Freeze** to enable or disable waveform freeze function. If enabled, the waveform display is frozen.

## Screen Saver

When the oscilloscope enters the idle state and holds for a certain period of time, the screen saver program will be enabled.

Press **More** → **Screen Saver** to enter the screen saver setting menu. Press **Screen Saver**, then rotate the multifunction knob  to select the screen saver type, and then press down the knob  to select the type. You can also press **Screen Saver** continuously or enable the touch screen to select the desired type. The available screen saver types include "Off", "Picture", and "Text". The screen saver program is disabled by default.

### 1. Select the Screen Saver

- If you select "Off" under **Screen Saver**, it indicates that the screen saver is disabled.
- If you select "Picture" under **Screen Saver**, press **Select Picture** to select the file. The file types include "\*.png", "\*.bmp", "\*.jpg", and "\*.tif".
- If you select "Text" under **Screen Saver**, press **Text**, and then the filename input interface is displayed, e.g. inputting "RIGOL Scope". For details, refer to descriptions in "**To Create a Folder**".

## 2. Set the Wait Time

Press **Time to Start**, rotate the multifunction knob  or use the pop-up numeric keypad to input the screen saver time. The available range is from 1 min to 999 min.

## 3. Preview

Press **Preview** to view the set screen saver.

## 4. Restore Defaults

Press **Default** to restore the screen saver to the default settings.





# Chapter 17 Function/Arbitrary Waveform Generator (Option)

MSO5000 series has an optional built-in dual-channel, 25 MHz signal source, which integrates the signal source and the oscilloscope into one, providing great convenience for engineers who need to use the signal source and oscilloscope at the same time. This chapter introduces how to use the built-in signal source. As the functions and setting methods of the two channels of the Function/Arbitrary Waveform Generator are the same, this chapter takes G1 as an example.

Contents in this chapter:

- To Output Basic Waveforms
- To Output the Arbitrary Waveform
- Modulation
- Sweep
- Burst



## To Output Basic Waveforms

Press **GI** on the front panel or enable the touch screen to tap the GI label at the bottom of the screen to enable/disable the output of the **[GI]** connector on the front panel, and enter the Function/Arbitrary Waveform Generator setting interface. MSO5000 series' built-in Function/Arbitrary Waveform Generator can output a variety of basic waveforms, including Sine, Square, Ramp, Pulse, DC, Noise, Sinc, Exp.Rise, Exp.Fall, ECG, Gauss, Lorentz, Haversine, and Arb.

## To Output Sine

Press **Wave**, rotate the multifunction knob  to select "Sine". Press down the knob to select it. You can also press **Wave** continuously or enable the touch screen to select it. At this time, you can set the parameters for the sine waveform.

### 1. Set the frequency or period

First select **Frequency** or **Period**, then rotate the multifunction knob  to select "Frequency" or "Period". You can also press **Frequency** or **Period** continuously to select it. Also, you can enable the touch screen to select it. Rotate the multifunction knob  or use the pop-up numeric keypad to set the frequency or period value of the current signal. Different waveforms have different frequency or period (reciprocal of the frequency) ranges.

Sine: 100 mHz to 25 MHz



Square: 100 mHz to 15 MHz

Ramp: 100 mHz to 1 MHz

Pulse: 100 mHz to 10 MHz

DC and Noise: no frequency parameter.

### 2. Set the amplitude or high level

First select **Amplitude** or **High Level**, then rotate the multifunction knob  to select "Amplitude" or "High Level". You can also press **Amplitude** or **High Level** continuously to select it. Also, you can enable the touch screen to select it. Rotate the multifunction knob  or use the pop-up numeric keypad to set the amplitude or high level value of the current signal. Note that if you select "Amplitude" for this menu, then the menu below the **Amplitude** is automatically turns out to be "Offset"; if you select "High Level" for this menu, then the menu below the **High Level** is automatically turns out to be "Low Level". When Impedance is set to "HighZ", the available range is from 20 mVpp to 5 Vpp; when Impedance is set to "50Ω", the available range is from 10 mVpp to 2.5 Vpp.

### 3. Set the offset or low level

First select **Offset** or **Low Level**, then rotate the multifunction knob  to select "Offset" or "Low Level". You can also press **Offset** or **Low Level**

continuously to select it. Also, you can enable the touch screen to select it. Rotate the multifunction knob  or use the pop-up numeric keypad to set the offset or low level value of the current signal. When Impedance is set to "HighZ", the available range is from  $(-2.5 \text{ V} + \text{currently set amplitude value}/2)$  to  $(2.5 \text{ V} - \text{currently set amplitude value}/2)$ ; when Impedance is set to "50Ω", the available range is from  $(-1.25 \text{ V} + \text{currently set amplitude value}/2)$  to  $(1.25 \text{ V} - \text{currently set amplitude value}/2)$ .

#### 4. Set the start phase

Press **Start Phase**, then rotate the multifunction knob  or use the pop-up numeric keypad to set the start phase of the current signal. Its available range is from 0° to 360°.

#### 5. Align phase

Pressing **Align Phase** will re-configure the two channels to output according to the preset frequency and phase. For two signals whose frequencies are the same or in multiple relationship, this operation can align their phases. Use the oscilloscope to acquire the waveforms of the two channels and stably display the waveforms. After switching the channel status, the phase deviation between the two waveforms is changed. At this time, press **Align Phase**, and then the phase deviation shown on the oscilloscope will restore to the current phase deviation between the two waveforms automatically.

#### 6. Setting options

Press **Settings** to enter the setting options menu. You can set the parameters such as modulation, sweep, burst, and impedance.

- **Modulation, sweep, and burst**

For details about modulation, sweep, and burst, refer to descriptions in "**Modulation**", "**Sweep**", and "**Burst**".

**Note:** When "Pulse", "DC", or "Noise" is selected under **Wave**, this menu is not available.

- **Set the impedance**

Press **Impedance** continuously to set the output impedance of the Function/Arbitrary Waveform Generator. It can be set to "HighZ" or "50Ω".

## To Output Square

Press **Wave**, rotate the multifunction knob  to select "Square". Press down the knob to select it. You can also press **Wave** continuously or enable the touch screen to select it. At this time, you can set the parameters for the square waveform. For setting methods, refer to descriptions in "**To Output Sine**". The duty cycle of the square waveform is a fixed value 50%.

## To Output Ramp

Press **Wave**, rotate the multifunction knob  to select "Ramp". Press down the knob to select it. You can also press **Wave** continuously or enable the touch screen to select it. At this time, you can set the parameters for the ramp waveform. For setting methods, refer to descriptions in "**To Output Sine**". This section only introduces "Symmetry".

Symmetry is defined as the percentage that the rising period of the ramp takes up in the whole period, as shown in the figure below.

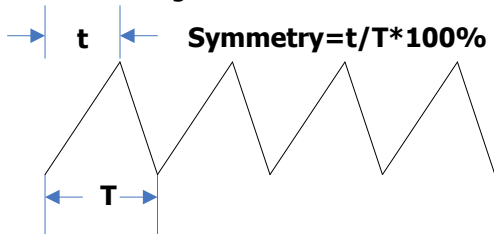



Figure 17-1 Symmetry Definition

Press **Settings** → **Symmetry**, then rotate the multifunction knob  or use the pop-up numeric keypad to set the symmetry of the ramp waveform. The settable range is from 0% to 100%.

## To Output Pulse

Press **Wave**, rotate the multifunction knob  to select "Pulse". Press down the knob to select it. You can also press **Wave** continuously or enable the touch screen to select it. At this time, you can set the parameters for the pulse waveform. For setting methods, refer to descriptions in "**To Output Sine**". This section only introduces "Duty Cycle".

Duty cycle is defined as the percentage that the high level takes up in the whole pulse period, as shown in the figure below.

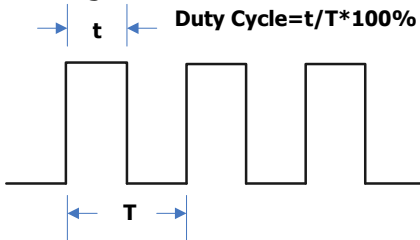





Figure 17-2 Duty Cycle Definition

Press **Settings** → **Duty Cycle**, then rotate the multifunction knob  or use the pop-up numeric keypad to set the duty cycle of the current pulse signal. Its settable range is from 10% to 90%.

## To Output DC

Press **Wave**, rotate the multifunction knob  to select "DC". Press down the knob to select it. You can also press **Wave** continuously or enable the touch screen to select it. At this time, you can set the offset and impedance of the DC signal.

### 1. Set the offset

Press **Offset**, then rotate the multifunction knob  or use the pop-up numeric keypad to set the offset value of the current DC signal. When the current impedance is set to HighZ, the settable range of offset is from -2.5 V to +2.5 V; when the impedance is set to 50 Ω, the settable range of offset is from -1.25 V to +1.25 V.



### 2. Set the impedance

Press **Impedance** continuously to set the output impedance of the Function/Arbitrary Waveform Generator. It can be set to "HighZ" or "50Ω".



## To Output Noise

Press **Wave**, rotate the multifunction knob  to select "Noise". Press down the knob to select it. You can also press **Wave** continuously or enable the touch screen to select it. At this time, you can set the amplitude/high level, offset/low level, and impedance of the noise signal.

### 1. Set the amplitude or high level

First select **Amplitude** or **High Level**, then rotate the multifunction knob  to select "Amplitude" or "High Level". You can also press **Amplitude** or **High Level** continuously to select it. Also, you can enable the touch screen to select it. Rotate the multifunction knob  or use the pop-up numeric keypad to set the amplitude or high level value of the current signal. Note that if you select "Amplitude" for this menu, then the menu below the **Amplitude** is automatically turns out to be "Offset"; if you select "High Level" for this menu, then the menu below the **High Level** is automatically turns out to be "Low Level".

### 2. Set the offset or low level

First select **Offset** or **Low Level**, then rotate the multifunction knob  to select "Offset" or "Low Level". You can also press **Offset** or **Low Level** continuously to select it. Also, you can enable the touch screen to select it. Rotate the multifunction knob  or use the pop-up numeric keypad to set the

offset or low level value of the current signal.

### 3. Set the impedance

Press **Impedance** continuously to set the output impedance of the Function/Arbitrary Waveform Generator. It can be set to "HighZ" or "50Ω".

## Sinc

Press **Wave**, rotate the multifunction knob  to select "Sinc". Press down the knob to select it. You can also press **Wave** continuously or enable the touch screen to select it. You can set the parameters for the Sinc waveform (as shown in the figure below). For setting methods, refer to descriptions in "**To Output Sine**".

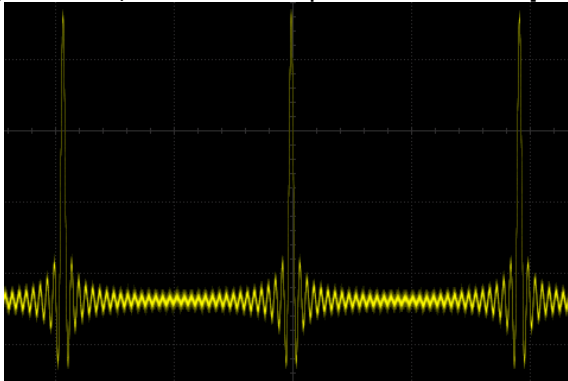



Figure 17-3 Sinc

## Exp.Rise

Press **Wave**, rotate the multifunction knob  to select "Exp.Rise ". Press down the knob to select it. You can also press **Wave** continuously or enable the touch screen to select it. At this time, you can set the parameters for the Exp.Rise waveform (as shown in the figure below). For setting methods, refer to descriptions in "**To Output Sine**".

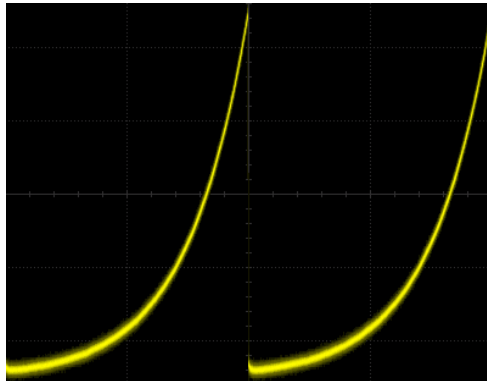



Figure 17-4 Exp.Rise

## Exp.Fall

Press **Wave**, rotate the multifunction knob  to select "Exp.Fall". Press down the knob to select it. You can also press **Wave** continuously or enable the touch screen to select it. At this time, you can set the parameters for the Exp.Fall waveform (as shown in the figure below). For setting methods, refer to descriptions in "**To Output Sine**".

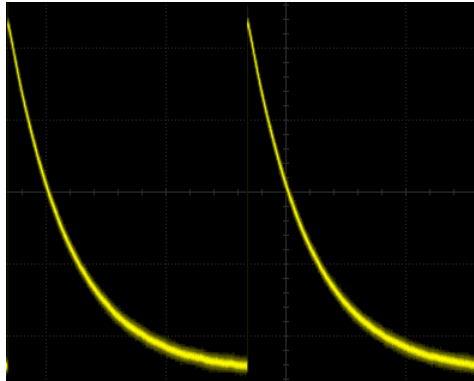



Figure 17-5 Exp.Fall

## ECG

Press **Wave**, rotate the multifunction knob  to select "ECG". Press down the knob to select it. You can also press **Wave** continuously or enable the touch screen to select it. At this time, you can set the parameters for the ECG waveform (as shown in the figure below). For setting methods, refer to descriptions in "**To Output Sine**".

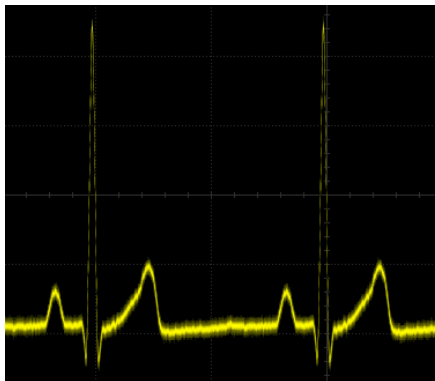



Figure 17-6 ECG

## Gauss

Press **Wave**, rotate the multifunction knob  to select "Gauss". Press down the

knob to select it. You can also press **Wave** continuously or enable the touch screen to select it. At this time, you can set the parameters for the Gauss waveform (as shown in the figure below). For setting methods, refer to descriptions in "**To Output Sine**".

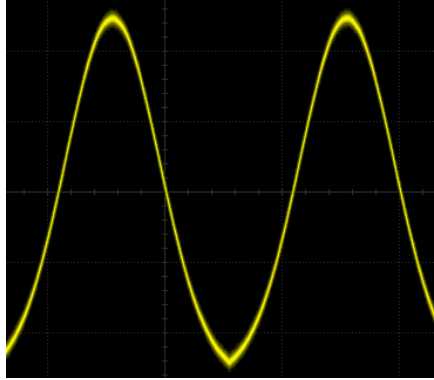



Figure 17-7 Gauss

## Lorentz

Press **Wave**, rotate the multifunction knob  to select "Lorentz". Press down the knob to select it. You can also press **Wave** continuously or enable the touch screen to select it. At this time, you can set the parameters for the Lorentz waveform (as shown in the figure below). For setting methods, refer to descriptions in "**To Output Sine**".

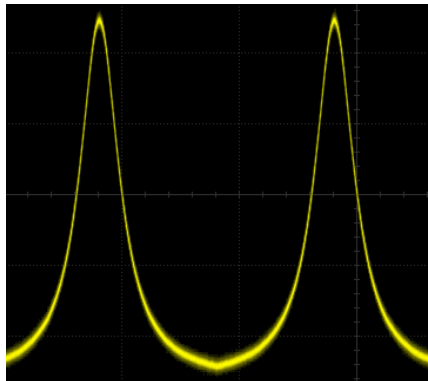



Figure 17-8 Lorentz

## Haversine

Press **Wave**, rotate the multifunction knob  to select "Haversine". Press down the knob to select it. You can also press **Wave** continuously or enable the touch screen to select it. At this time, you can set the parameters for the Haversine waveform (as shown in the figure below). For setting methods, refer to descriptions in "**To Output Sine**".



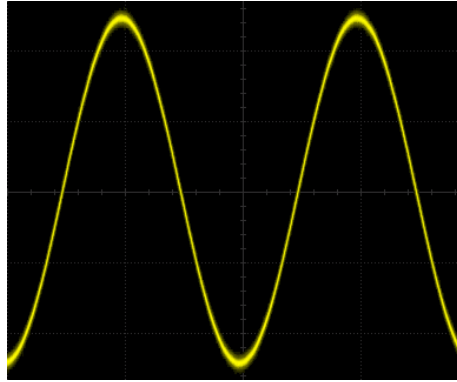

Figure 17-9 Haversine

## To Output the Arbitrary Waveform

MSO5000 series oscilloscope allows you to define the arbitrary waveform and save it to the internal or external memory. The user-defined waveform can contain 1 to 16,384 data points (i.g. 1 pts to 16 kpts).

Press **Wave**, rotate the multifunction knob  to select "Arb". Press down the knob to select it. You can also press **Wave** continuously or enable the touch screen to select it. At this time, you can set the parameters for the arbitrary waveform.

## To Load the Channel and Waveform

### 1. Load the Channel

Press **Load from CH** to enter the channel loading menu. You can set the channel signal required to be loaded.

- **Channel selection**

Press **Channel** and rotate the multifunction knob  to select the desired channel (CH1-CH4), and then press down the knob to select it. You can also press **Channel** continuously or enable the touch screen to select it.

- **Set the waveform range**

Press **Region** continuously to set the waveform in the "Cursor" or "Screen" region for load. When "Cursor" is selected, press **Cursor A** or **Cursor B** and rotate the multifunction knob  to adjust the positions of the two cursors respectively; or press **Cursor AB** and rotate the knob to adjust the positions of cursors A and B at the same time to determine the waveform range.

- **Load**

Press **Load** to load the set channel signal.



## 2. Load the Waveform

Press **Load Stored** to enter the waveform loading interface. In the disk management interface, select the waveform from the internal memory or the external memory. The waveform file is suffixed with "\*.arb". Then, press **Load** to load the selected waveform. For details, refer to descriptions in "**Store and Load**".



## To Create the Waveform

You can create arbitrary waveforms according to your needs. Press **Create** to enter the waveform creation menu. Meanwhile, the waveform editor is displayed on the screen.



- **Set the frequency or period**

First select **Frequency** or **Period**, then rotate the multifunction knob  to select "Frequency" or "Period". You can also press **Frequency** or **Period** continuously to select it. Also, you can enable the touch screen to select it. Rotate the multifunction knob  or use the pop-up numeric keypad to set the frequency or period value of the current signal.

- **Set the amplitude or high level**

First select **Amplitude** or **High Level**, then rotate the multifunction knob  to select "Amplitude" or "High Level". You can also press **Amplitude** or **High Level** continuously to select it. Also, you can enable the touch screen to select it. Rotate the multifunction knob  or use the pop-up numeric keypad to set the amplitude or high level value of the current signal. Note that if you select "Amplitude" for this menu, then the menu below the **Amplitude** is automatically turns out to be "Offset"; if you select "High Level" for this menu, then the menu below the **High Level** is automatically turns out to be "Low Level".

- **Set the offset and low level**

First select **Offset** or **Low Level**, then rotate the multifunction knob  to select "Offset" or "Low Level". You can also press **Offset** or **Low Level** continuously to select it. Also, you can enable the touch screen to select it. Rotate the multifunction knob  or use the pop-up numeric keypad to set the offset or low level value of the current signal.

- **Set the initial number of points**

The initial number of points indicates the number of editable points. By default, the number of editable points of arbitrary waveforms created can be preset to 2. Point 1 is fixed at 0 s and Point 2 is fixed at the middle of the period. Press **Init Points**, then rotate the multifunction knob  or use the pop-up numeric keypad to set the number of editable points for the arbitrary waveform. The

maximum number of editable points supported by the system is 16,384 (16 kpts).

- **Linear interpolation**

Press **Linear Interp** to enable or disable the linear interpolation between the defined points of the waveform.

- **ON:** the waveform editor connects two points using a straight line.
- **OFF:** the waveform editor will keep a constant voltage level between two points and create a ladder-like waveform.

- **Edit points**

Press **Edit Points** to enter the point editing menu. You can specify the voltage value for each waveform point to define the waveforms.

- **Current Point**

Press **PointX**, then rotate the multifunction knob  or use the pop-up numeric keypad to select the points to be edited. The available range is from 1 to the number of initial points.

- **Voltage**

Press **Voltage**, then rotate the multifunction knob  or use the pop-up numeric keypad to set the voltage value of the current point. Its available range is from -2.5 V to +2.5 V.

- **Insert**

Press **Insert** to insert a new editable point in the middle position between the current editing point and the next editing point. The number of initial points adds 1 automatically. You can press **Insert** continuously to increase the editable points gradually.

- **Delete**

Press **Delete** to delete the current point from the waveform, and connect the remaining points with the current interpolation method.

**Note:** The 1<sup>st</sup> Point cannot be deleted.

- **Zoom**

Press **Zoom** continuously to enable or disable the zoom function of horizontal time base.

- **Apply**

Press **Apply** to apply the current settings for the currently edited arbitrary waveforms and output the edited waveforms.



- **Save the arbitrary waveform**

Press **Save** to enter the file saving interface. Please refer to descriptions in "**Store and Load**" to save the currently edited waveform file to the internal or external memory in "\*.arb" format (you can overwrite the original file or save the currently edited waveform again).



## To Edit Waveforms

You can edit the waveforms in the current volatile memory. Press **Edit** to enter the waveform editing menu.



- **Set the frequency or period**

First select **Frequency** or **Period**, then rotate the multifunction knob  to select "Frequency" or "Period". You can also press **Frequency** or **Period** continuously to select it. Also, you can enable the touch screen to select it. Rotate the multifunction knob  or use the pop-up numeric keypad to set the frequency or period value of the current signal.

- **Set the amplitude or high level**

First select **Amplitude** or **High Level**, then rotate the multifunction knob  to select "Amplitude" or "High Level". You can also press **Amplitude** or **High Level** continuously to select it. Also, you can enable the touch screen to select it. Rotate the multifunction knob  or use the pop-up numeric keypad to set the amplitude or high level value of the current signal. Note that if you select "Amplitude" for this menu, then the menu below the **Amplitude** is automatically turns out to be "Offset"; if you select "High Level" for this menu, then the menu below the **High Level** is automatically turns out to be "Low Level".

- **Set the offset and low level**

First select **Offset** or **Low Level**, then rotate the multifunction knob  to select "Offset" or "Low Level". You can also press **Offset** or **Low Level** continuously to select it. Also, you can enable the touch screen to select it. Rotate the multifunction knob  or use the pop-up numeric keypad to set the offset or low level value of the current signal.

- **Linear Interpolation**

Press **Linear Interp** to enable or disable the linear interpolation between the defined points of the waveform.

- **ON:** enables the linear interpolation. The waveform editor connects two defined points by using a straight line.
- **OFF:** disables the linear interpolation. The waveform editor will keep a constant voltage level between two points and create a ladder-like waveform.

- **Edit Points**

Press **Edit Points** to enter the point editing menu. You can specify the voltage value for each waveform point to define the waveforms.

- **Current Point**

Press **PointX**, then rotate the multifunction knob  or use the pop-up numeric keypad to select the points to be edited. The available range is from 1 to the number of initial points.

- **Voltage**  
Press **Voltage**, then rotate the multifunction knob  or use the pop-up numeric keypad to set the voltage value of the current point. Its available range is from -2.5 V to +2.5 V.
  - **Insert**  
Press **Insert** to insert a new editable point in the middle position between the current editing point and the next editing point. The number of initial points adds 1 automatically. You can press **Insert** continuously to increase the editable points gradually.
  - **Delete**  
Press **Delete** to delete the current point from the waveform, and connect the remaining points with the current interpolation method.  
**Note:** The 1<sup>st</sup> Point cannot be deleted.
  - **Zoom**  
Press **Zoom** continuously to enable or disable the zoom function of horizontal time base.
  - **Apply**  
Press **Apply** to apply the current settings for the currently edited arbitrary waveforms and output the edited waveforms.
- **Save the arbitrary waveform**  
Press **Save** to enter the file saving interface. Please refer to descriptions in "**Store and Load**" to save the currently edited waveform file to the internal or external memory in "\*.arb" format (you can overwrite the original file or save the currently edited waveform again).

## Modulation

The built-in Function/Arbitrary Waveform Generator of MSO5000 series oscilloscope supports amplitude modulation (AM), frequency modulation (FM), and frequency-shift keying modulation (FSK). A modulated waveform consists of a carrier waveform and a modulating waveform. The carrier waveform is the waveform output from the Function/Arbitrary Waveform Generator, and the modulating signal can be the built-in sine, square, triangle waveform, or noise signal.

Press **Settings** → **Type**, and rotate the multifunction knob  to select "Modulation", and then press down the knob to select it. You can also press **Type** continuously or enable the touch screen to select it.

Press **Type**, and rotate the multifunction knob  to select the desired modulation type, and then press down the knob to select it. You can also press **Type** continuously or enable the touch screen to select it. The available modulation types include AM, FM, and FSK.

## AM

AM (Amplitude Modulation), namely the amplitude of the carrier waveform changes with the amplitude of the modulating waveform, as shown in the figure below.

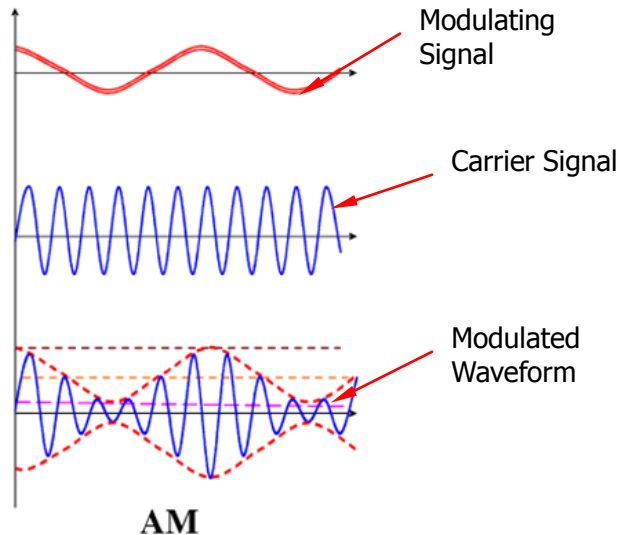



Figure 17-10 Amplitude Modulation

### 1. Select the Modulating Waveform

Press **Waveform**, and rotate the multifunction knob  to select the desired modulating waveform, and then press down the knob to select it. You can also press **Waveform** continuously or enable the touch screen to select it. The available modulating waveforms include Sine, Square, Triangle, and Noise.

### 2. Set the Modulation Frequency

Press **Frequency**, then rotate the multifunction knob  or use the pop-up numeric keypad to set the frequency of the modulation signal. The available range is from 1 Hz to 50 kHz.

### 3. Set the Modulation Depth

The modulation depth refers to the strength of the AM and is expressed in percentage. Press **AM Depth**, then rotate the multifunction knob  or use the pop-up numeric keypad to set the AM depth of the modulating waveform. The available range is from 0% to 120%. When it is set to 0%, the output amplitude is half of the carrier amplitude. When it is set to 100%, the output amplitude equals the carrier amplitude. When it is set to a value greater than 100%, envelop distortion will occur, which must be avoided in actual circuit; at this point, the output of the instrument will not exceed 2.5 Vpp (the load is 50  $\Omega$ ).

## FM

FM (Frequency Modulation), namely the frequency of the carrier waveform changes with that of the modulating waveform, as shown in the figure below.

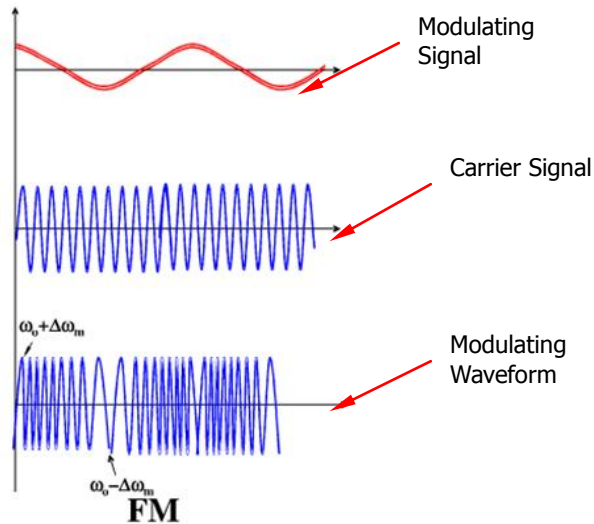



Figure 17-11 Frequency Modulation

### 1. Select the Modulating Waveform

Press **Waveform**, and rotate the multifunction knob  to select the desired modulating waveform, and then press down the knob to select it. You can also press **Waveform** continuously or enable the touch screen to select it. The available modulating waveforms include Sine, Square, Triangle, and Noise.

### 2. Set the Modulation Frequency

Press **Frequency**, then rotate the multifunction knob  or use the pop-up numeric keypad to set the frequency of the modulation signal. The available range is from 1 Hz to 50 kHz.

### 3. Set the Frequency Offset

Press **Deviation**, then rotate the multifunction knob  or use the pop-up numeric keypad to set the frequency deviation of modulating waveform from the carrier frequency. The available range of the frequency deviation is from 0 Hz to the frequency of the current carrier waveform, and the sum of the frequency deviation and carrier frequency cannot be greater than the maximum frequency of the current carrier waveform.

## FSK

FSK (Frequency-shift Keying) is a modulation method that uses the digital signal to control the carrier frequency changes. It is one of the modulation methods that have

been early used in information transmission. Its advantages lie in good performance in anti-noise and anti-attenuation, and it has been widely used in low and medium rate of data transmission.

### 1. Set the Modulation Polarity

Press **Polarity** continuously to select "Positive" or "Negative" of the modulating waveform to control the frequency output.

### 2. Set the Modulation Frequency

Press **FSK Rate**, then rotate the multifunction knob  or use the pop-up numeric keypad to set the frequency of the modulation signal. The available range is from 1 Hz to 50 kHz.

### 3. Set the Hopping Frequency

Hopping frequency indicates the frequency of the modulating waveform. The range of the hopping frequency is from 100 mHz to the maximum frequency of the carrier waveform. By default, it is 1 kHz. Press **Hop Freq**, then rotate the multifunction knob  or use the pop-up numeric keypad to set the hopping frequency.

## Sweep

The built-in Function/Arbitrary Waveform Generator of MSO5000 series oscilloscope supports the sweep function. In the sweep mode, the Function/Arbitrary Waveform Generator outputs from the start frequency to the end frequency at a specified sweep time. MSO5000 series supports 3 sweep modes: Linear, Log, and Step. You are allowed to set the parameters such as Start Keep, End Keep, and Return Time. Internal and Manual trigger sources are supported. The sweep output is available for Sine, Square, Ramp, and Arb (DC excluded) waveforms.

Press **Settings** → **Type**, and rotate the multifunction knob  to select "Sweep", and then press down the knob to select it. You can also press **Type** continuously or enable the touch screen to select it.

### 1. Set the Sweep Type

Press **Sweep Type**, and rotate the multifunction knob  to select the desired sweep type, and then press down the knob to select it. You can also press **Sweep Type** continuously or enable the touch screen to select it. The available sweep types include Linear, Log, and Step.

- Linear: the frequency of the signal changes linearly.
- Log: the frequency of the signal changes in log form.
- Step: the frequency of the signal changes with ladder-like step.





## 2. Sweep Settings

Press **Settings** to enter the sweep setting menu.

- **Set start frequency and end frequency**

Start frequency and end frequency indicate the upper and lower limits of the sweep frequency. The Function/Arbitrary Waveform Generator always sweeps from the start frequency to the end frequency, and then returns back to the start frequency.

- When start frequency is smaller than the end frequency, the Function/Arbitrary Waveform Generator sweeps from low frequency to high frequency.
- When start frequency is greater than the end frequency, the Function/Arbitrary Waveform Generator sweeps from high frequency to low frequency.
- When start frequency is equal to the end frequency, the Function/Arbitrary Waveform Generator outputs at a fixed frequency.

Press **Start Freq**, then rotate the multifunction knob  or use the pop-up numeric keypad to set the start frequency. Press **End Freq**, then rotate the multifunction knob  or use the pop-up numeric keypad to set the end frequency. By default, the start frequency is 100 Hz, and the end frequency is 1 kHz. The ranges of start frequency and end frequency for different sweep waveforms are different. After modifying the "Start Freq" and "End Freq", the Function/Arbitrary Waveform Generator will restart to output from the specified "Start Freq".

- **Start Keep**

Start keep indicates the time that the output signal keeps outputting at the "Start Freq" after the sweep starts. After the start keep time expires, the Function/Arbitrary Waveform Generator will continue outputting at a different frequency based on the current sweep type.

Press **Start Keep**, then rotate the multifunction knob  or use the pop-up numeric keypad to set the start keep time. The default is 0 s, and the range is from 0 s to 500 s.

- **End Keep**

End keep indicates the time that the output signal continues outputting at the "End Freq" after the Function/Arbitrary Waveform Generator sweeps from "Start Freq" to "End Freq".

Press **End Keep**, then rotate the multifunction knob  or use the pop-up numeric keypad to set the end keep time. The default is 0 s, and the range is from 0 s to 500 s.

- **Set the step**

When the sweep type is set to "Step", this menu is enabled and can be settable. Press **Step number**, then rotate the multifunction knob  or use the pop-up numeric keypad to set the step value. By default, it is 2. Its available range is from 2 to 1000.

- **Set the trigger source**

The trigger sources of the sweep can be Internal or Manual. When the Function/Arbitrary Waveform Generator receives a trigger signal, a sweep output is generated, and then it waits for another trigger signal.

Press **Trig Source** and rotate the multifunction knob  to select the desired trigger source, and then press down the knob to select it. You can also press **Trig Source** continuously or enable the touch screen to select it. The available trigger sources include Internal and Manual.

- Internal: the Function/Arbitrary Waveform Generator outputs continuous sweep waveforms.
- Manual: when you press **Manual Trig** for one time, one sweep is immediately launched for the corresponding channel.

### 3. Set the Sweep Time

Press **Sweep Time**, then rotate the multifunction knob  or use the pop-up numeric keypad to set the sweep time. By default, it is 1 s. Its available range is from 1 ms to 500 s. After modifying the sweep time, the Function/Arbitrary Waveform Generator will restart to output from the specified "Start Freq".

### 4. Set the Return Time

Return time indicates the time that the output signal restores from "End Freq" to "Start Freq" after the Function/Arbitrary Waveform Generator sweeps from "Start Freq" to "End Freq" and the "End Keep" time expires.

Press **Return Time**, then rotate the multifunction knob  or use the pop-up numeric keypad to set the return time. By default, it is 0 s. Its available range is from 0 s to 500 s.

## Burst

The built-in Function/Arbitrary Waveform Generator of MSO5000 series oscilloscope supports outputting the burst waveforms with a specified number of cycles. It supports using internal and manual trigger sources to control the output of the burst waveforms. Two burst types are supported: N Cycle and Infinite.

Press **Settings** → **Type**, and rotate the multifunction knob  to select "Burst", and then press down the knob to select it. You can also press **Type** continuously or enable the touch screen to select it.

### 1. Set the Burst Type

Press **Burst Type**, and rotate the multifunction knob  to select the desired burst type, and then press down the knob to select it. You can also press **Burst Type** continuously or enable the touch screen to select it. The available burst types include N Cycle and Infinite.

- N Cycle: outputs the burst waveforms with a specified number of cycles once receiving the trigger signal.
- Infinite: sets the number of cycles to Infinite. It outputs continuous waveforms once receiving the trigger signal.

### 2. Set the Number of Cycles

When the burst type is set to "N Cycle", you need to set the number of cycles.

Press **Cycles**, then rotate the multifunction knob  or use the pop-up numeric keypad to set the number of cycles. For the Infinite burst type, the **Cycles** menu is disabled and grayed out.

### 3. Set the Burst Delay

Burst delay indicates the time from when receiving the trigger signal to starting to output N Cycle of bursts or Infinite burst.

Press **Delay**, then rotate the multifunction knob  or use the pop-up numeric keypad to set the desired delay time. The range of the delay time related to the burst cycles.

### 4. Burst Setting

Press **Settings** to enter the burst setting menu.

- **Set the trigger source**

The trigger sources of the burst can be Internal or Manual. When the Function/Arbitrary Waveform Generator receives a trigger signal, a burst output is generated, and then it waits for another trigger signal.

Press **Trig Source** and rotate the multifunction knob  to select the desired trigger source, and then press down the knob to select it. You can also press **Trig Source** continuously or enable the touch screen to select it. The available trigger sources include Internal and Manual. For the Infinite burst type, the **Trig Source** menu is disabled and grayed out.

- Internal: the Function/Arbitrary Waveform Generator outputs continuous N cycle bursts.
- Manual: when you press **Manual Trig** for one time, one burst output is immediately launched for the corresponding channel. For the Infinite burst type, the **Cycles** menu is disabled and grayed out.

- **Set the burst period**

It is defined as the time from the beginning of one burst to that of another burst.

Press **Burst Period**, then rotate the multifunction knob  or use the pop-up numeric keypad to set the desired burst period. Its available range is from 1 ms to 500 s. By default, it is 10 ms.

# Chapter 18 Store and Load

You can save the current settings, waveforms, screen image, and parameters of the oscilloscope in internal memory or external storage device (such as USB storage device) in various formats and load the stored settings or waveforms when needed. You can also copy a new file of the specified type as well as delete and rename the specified type of file in the internal memory or external USB storage device via the disk management menu.

**Note:** MSO5000 only supports the flash memory USB storage device of FAT32 format.

Contents in this chapter:

- Storage System
- Storage Type
- Load Type
- Internal Storage and Load
- External Storage and Load
- Disk Management
- Factory Settings

## Storage System

Press **Storage** on the front panel to enter the store and load setting interface. It provides one USB HOST interfaces on the front panel and one USB HOST interface on the rear panel, which can all be connected to the USB storage device for external storage. The USB storage devices connected are marked as "Removable USB Disk(D)", "Removable USB Disk(E)", "Removable USB Disk(F)", and "Removable USB Disk(G)", respectively.

## Storage Type

The file types for storage include image, waveform, and setups. The storage descriptions of each type are as follows.

### 1. Image

Press **Save Image** → **Format**, and then use the multifunction knob  to select the image type. You can also press **Format** continuously or enable the touch screen to select it. Save the screen image to the internal or external memory in "\*.png", "\*.bmp", "\*.jpg", or "\*.tif" format.

After selecting this type:

- Press **File Name** to input the file name to be saved. For filename input, refer to descriptions in "**To Create a Folder**". Press **More** → **Auto Name** to select "ON", then the filename is generated automatically. If the filename that you input is the same as the existing filename, a prompt message will be displayed, reminding you that the existing file will be overwritten and asking you whether to continue or not.
- Press **Invert** to enable or disable the invert function.
- Press **Color** to select the desired storage color. It can be set to "Gray" or "Color".
- Press **Window** to display or hide the disk management interface.
- Press **Save** to save the set image file. Press **More** → **Header** to select "ON" or "OFF". If you select "ON", the instrument model, firmware version number, serial number, and the image creation date will be displayed in the header of the image when you save the image file.

#### Tip

After a USB storage device (FAT32 format, flash memory) is connected, press **Quick** on the front panel to save the file. You can select to save to the internal memory or the external USB storage device. By default, it is saved to the internal memory.

## 2. Wave

Press **Save Wave** to enter the waveform storage setting interface. Save the main setting information (e.g. "On/Off" state of the channel, vertical scale, and horizontal time base) and waveform data of all enabled channels (analog channel and digital channel) to the external memory.

After selecting this type:

- Press **Data Source** to select "Screen" or "Memory".
- Press **Format** to select the format of the waveform storage, such as "\*.bin", "\*.csv", and "\*.wfm" (when "Memory" is selected under **Data Source**).
- Press **File Name** to input the file name to be saved. For filename input, refer to descriptions in **"To Create a Folder"**. Press **More** → **Auto Name** to select "ON", then the filename is generated automatically. If the filename that you input is the same as the existing filename, a prompt message will be displayed, reminding you that the existing file will be overwritten and asking you whether to continue or not.
- Press **Channel**, and then the available storage channels include CH1-CH4 and D0-D15. Only when you select "Memory" under **Data Source** and the format is "\*.bin" or "\*.csv", can you set the storage channel.
- Press **Window** to display or hide the disk management interface.
- Press **Save** to save the set waveform file.

## 3. Setup

Press **Save Setup** to enter the setup setting interface. Save the setups of the oscilloscope to the internal or external memory in "\*.stp" format. The stored setups can be recalled.

After selecting this type:

- Press **File Name** to input the file name to be saved. For filename input, refer to descriptions in **"To Create a Folder"**. Press **More** → **Auto Name** to select "ON", then the filename is generated automatically. If the filename that you input is the same as the existing filename, a prompt message will be displayed, reminding you that the existing file will be overwritten and asking you whether to continue or not.
- Press **Save** to save the set setup file.

# Load Type

This oscilloscope provides two load types: waveform load and setup load. The descriptions of each load type are as follows.

## 1. Waveform Load

Press **Load Wave** to load the waveforms from the internal memory or the external USB disk. The default file type is "\*.wfm", and no other options are available. Load the file from the memory, then press **Load** to load the selected file.





## 2. Setup Load

Press **Load Setup** to load the setups from the internal memory or the external USB disk. The default file type is "\*.stp", and no other options are available. Load the file from the memory, then press **Load** to load the selected file.

# Internal Storage and Load

The internal memory supports the storage and load of the image file, waveform file, setup file, reference waveform file, and pass/fail test mask file.

## 1. Save the Specified Oscilloscope Setups to the Internal Memory (Take Save Setup as an Example)







- 1) Connect a signal to the oscilloscope and obtain the stable display of waveforms.
- 2) Press **Storage** → **Save Setup** to enter the setup storage interface. The disk management interface is displayed automatically. By default, "Local Disk(C)" is selected.
- 3) Rotate the multifunction knob  or enable the touch screen to open the internal memory storage interface.
- 4) Rotate the multifunction knob  to select the desired storage location, and then press down the knob to open it. You can also enable the touch screen to select the storage location. Rotate the multifunction knob  to select , then press down the knob or enable the touch screen to tap  to go to the previous location. Besides, you can also press **NewFolder** to create a new storage folder. For details, refer to descriptions in "**To Create a Folder**".
- 5) Press **File Name** to name the setup file for storage. For details, refer to descriptions in "**To Create a Folder**". Press **More** → **Auto Name** to select "ON", then the filename is generated automatically. If the filename that you input is the same as the existing filename, a prompt message will be displayed, reminding you that the existing file will be overwritten and asking you whether to continue or not.
- 6) Press **Save** to save the set setup file to the selected folder in "\*.stp" format.



**Tip**

1. After saving the reference waveform, press **Ref** → **More** → **Export** to enter the disk management interface of reference waveform file storage.
2. Press **Utility** → **PassFail** to enable the pass/fail test function. Then press **Mask** → **Save** to enter the disk management interface of pass/fail test mask file storage.

**2. Load the Setup File from the Internal Memory (Take Load Setup as an Example)**

- 1) Press **Storage** → **Load Setup** to enter the setup load interface. The disk management interface is displayed automatically. By default, "Local Disk(C)" is selected.
- 2) Rotate the multifunction knob  or enable the touch screen to open the internal memory storage interface.
- 3) Rotate the multifunction knob  to select the desired storage location, and then press down the knob to open it. You can also enable the touch screen to select the storage location. Rotate the multifunction knob  to select , then press down the knob or enable the touch screen to tap  to go to the previous location.
- 4) Rotate the multifunction knob  to select the file to be loaded (the default file type is in "\*stp" format). Then, the **Load** menu is enabled. Press **Load** to load the selected file. You can also enable the touch screen to operate.





**Tip**

- Press **Ref** → **More** → **Import** to enter the disk management interface of reference waveform file load.
- Press **Utility** → **PassFail** to enable the pass/fail test function. Then press **Mask** → **Load** to enter the disk management interface of pass/fail test mask file load.





## External Storage and Load

Before external storage and recall, ensure that the USB disk is properly connected. The external memory supports image saving, waveform saving, setup saving, waveform loading, and setup loading.



### 1. Save the Specified Type of File in the External USB Storage Device (Take Waveform Saving as an Example)

- 1) Connect a signal to the oscilloscope and obtain the stable display of waveforms.
- 2) Press **Storage** → **Save Wave** to enter the waveform storage interface. The disk management interface is displayed automatically.
- 3) Rotate the multifunction knob  to select one disk from "Removable USB Disk(D/E/F/G...)". Press down the knob to open the external disk storage interface. You can also enable the touch screen to select the storage location. Rotate the multifunction knob  to select , then press down the knob or enable the touch screen to tap  to go to the previous location. Besides, you can also press **NewFolder** to create a new storage folder. For details, refer to descriptions in "**To Create a Folder**".
- 4) To set the waveform saving, refer to descriptions of "Wave" in "**Storage Type**".
- 5) Press **Save** to save the waveform file to the selected folder in the specified save format.

### 2. Load the Specified Type of File from the External USB Storage Device (Take Waveform Loading as an Example)

- 1) Press **Storage** → **Load Wave** to enter the waveform loading interface. The disk management interface is displayed automatically.
- 2) Rotate the multifunction knob  to select one disk from "Removable USB Disk(D/E/F/G...)". Press down the knob to open the external disk storage interface. You can also enable the touch screen to select the load location. Rotate the multifunction knob  to select , then press down the knob or enable the touch screen to tap  to go to the previous location.
- 3) Rotate the knob  to select the file to be loaded, then the **Load** menu is enabled. Press **Load** to load the selected file. You can also enable the touch screen to operate.

## Disk Management

Press **Storage** → **Disk** to turn on the disk management interface as shown in Figure 18-1. Rotate the multifunction knob  to select the desired disk. The disk currently selected is displayed in blue shading. Press down the knob  to open the selected disk. You can also enable the touch screen to select the disk.

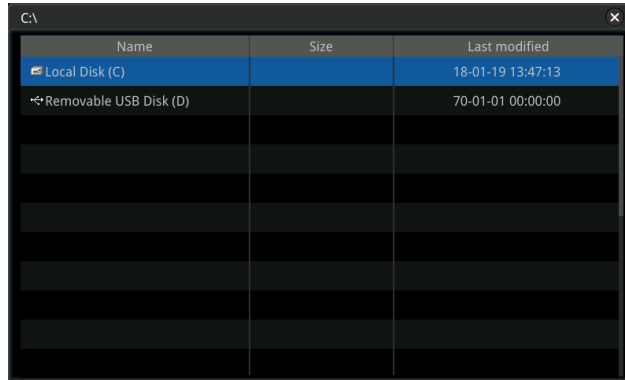



Figure 18-1 Disk Management Interface

Execute the following operations through the disk management menu:

- To Select a File Type
- To Create a Folder
- To Delete a File or Folder
- To Copy and Paste a File or Folder
- To Rename a File or Folder
- To Clear the Internal Memory Safely

## To Select a File Type

Except the image storage, waveform storage, and setup storage, the oscilloscope can also save the files of advanced applications.

Press **Storage** → **Disk** → **File Type**, rotate the multifunction knob  to select the desired file type. The default is "\*.\*". In the current path, only the file whose suffix of its file name matches that of the file type selected will be displayed in the current path.

## To Create a Folder

Before using the external disk, make sure that a USB storage device (FAT32 format, flash memory) is connected correctly.

In the disk management interface, rotate the multifunction knob  to select the storage location. By default, the internal memory "Local Disk(C)" is selected. Press **NewFolder** to enter the interface, as shown in Figure 18-2.

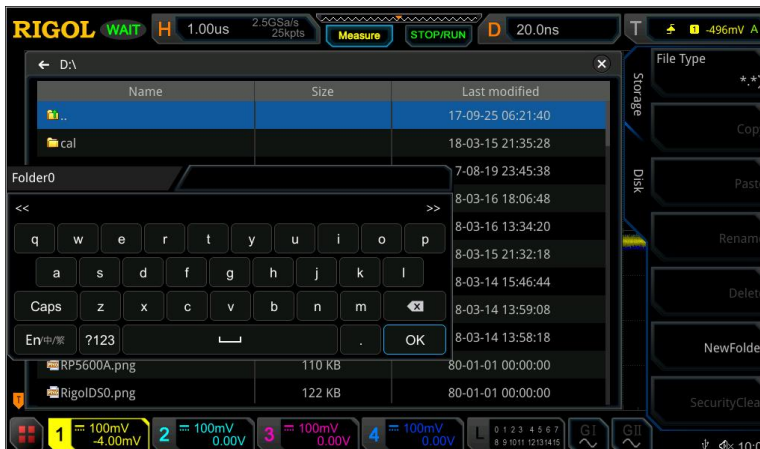



Figure 18-2 To Create a Folder

This oscilloscope supports Chinese/English input method. The length of the folder name is limited to 10 bytes (one Chinese character occupies two bytes). The following part introduces how to input a folder name using Chinese/English input method.

**Tip**  
During the name input, rotate the multifunction knob  to select the desired contents. Press down the knob to input the desired contents, or enable the touch screen and tap the desired contents to select it.

### English Input Method



For example, create a folder with the name "Filename".

Name Input Area    English Selection Area    Letter Input Area    Virtual Keypad



Go to Previous Page    Go to Next Page

Upper/lower Case Switch    Input Method Switch





### 1. Select English Input Method

If the current input method is "En/中/繁", please go to Step 2. If the current input method is "中/繁/En" or "繁/En/中", rotate the multifunction knob  to select the input switch key and press the knob  continuously to switch to "En/中/繁". "En" is located first and highlighted.

### 2. Clear the Name Input Area

If there is no character in the "Name Input Area", please go to Step 3. If there are characters in the "Name Input Area", press rotate the multifunction knob  to select the Delete key  to delete all the characters in the name input area in order.



### 3. Input the First Character "F"

- 1) If the current setting is uppercase input, please go to Step 2). If the current setting is lowercase input, rotate the multifunction knob  to select "Caps" and press down the knob to switch to the uppercase input.
- 2) Rotate the multifunction knob  to select "F" and press down the knob. The character is displayed in the English selection area.
- 3) In the English selection area, rotate the multifunction knob  to select "F" and press it down. Then, "F" is displayed in the name input area, "F" is input successfully. If the character is not found in the current page, press  to go to the next page until you find the desired character.

### 4. Input the Other Characters

Use the same method to input the remaining letters "ilename" by referring to Step 3. Pay attention to the upper-lower case of the letters when inputting them.

### 5. Modify or Delete the Unwanted Characters that Have Been Entered.

While entering a filename, you can modify or delete the unwanted character if necessary. To delete the input characters, rotate the multifunction knob  in the virtual keypad to select the delete key . Press down the key to delete the characters. To modify the input characters, delete the unwanted characters and input the desired characters again. If the character to be modified is in the middle, press the delete key  to delete the characters starting from the last one to the character to be modified, then input the new character again.

If the touch screen is enabled, tap to directly move the cursor to the character required to be modified or deleted, and then input the desired character again or delete the unwanted character.

#### Tip

If characters already exist in the letter input area, when you rotate the multifunction knob  to delete the characters in the name input area, the characters in the letter input area will be deleted first.



6. After finishing the input, rotate the multifunction knob  and press **OK**. The oscilloscope will create a folder or a specified type of file with this name under the current directory.

## Simplified Chinese (or Traditional Chinese) Input Method



For example, create a folder with the name "文件名". Note that the input method of traditional Chinese is the same as that of the simplified Chinese.



### 1. Chinese Input Method

If the current input method is "中/繁/En", please go to Step 2. If the current input method is "En/中/繁" or "繁/En/中", rotate the multifunction knob  to select the input switch key and press the knob  continuously to switch to "中/繁/En". "中" is located first and highlighted.

### 2. Clear the Pinyin Input Area and Name Input Area

If there is no character in the "Pinyin Input Area" and "Name Input Area", please go to Step 3. If there are characters in the "Name Input Area" and "Pinyin Input Area", press rotate the multifunction knob  to select the delete key  to delete all the characters in the name input area in order.

### 3. Input the first Chinese character "文"

- 1) Input the pinyin "wen" in the "Pinyin Input Area"
 

Rotate the multifunction knob  to select the first letter "w" in the pinyin "wen" and press down the knob to input "w" in the "Pinyin Input Area". Use the same method to input the remaining letters "en" in the pinyin "wen". After finishing the input, the Chinese characters available are displayed in the "Chinese Character Selecting Area".
- 2) Select the desired Chinese character from the "Chinese Character Selecting Area"
 



Rotate the multifunction knob  to select "文", and press down the knob,

then "文" is input in the "Name Input Area". If the Chinese character is not found in the current page, press  to go to the next page until you find the desired character.

#### 4. Input the Other Characters

Refer to Step 3 and use the same method to input the remaining Chinese characters "件名" in sequence.

#### 5. Modify or Delete the Unwanted Characters that Have Been Entered.

When inputting the filename, you can modify or delete the filename characters input in the "Name Input Area" as well as delete the pinyin characters input in the "Pinyin Input Area". To delete the input characters, rotate the multifunction knob  in the virtual keypad to select the delete key . Press down the key to delete the characters. To modify the input characters, delete the unwanted characters and input the desired characters again. If the character to be modified is in the middle, press the delete key  to delete the characters starting from the last one to the character to be modified, then input the new character again.

If the touch screen is enabled, tap to directly move the cursor to the character required to be modified or deleted, and then input the desired character again or delete the character.



#### Tip

If characters already exist in the Pinyin input area, when you rotate the multifunction knob  to delete the characters in the name input area, the characters in the Pinyin input area will be deleted first.



6. After finishing the input, rotate the multifunction knob  and press **OK**. The oscilloscope will create a folder or a specified type of file with this name under the current directory.

## To Delete a File or Folder

### 1. Delete a File or Folder from the Internal Memory

- 1) Press **Storage** → **Disk** and rotate the multifunction knob  to select the internal memory "Local Disk(C)". Press down the knob to open it.
- 2) Rotate the multifunction knob  to select the file or the folder to be deleted.
- 3) Press **Delete**, and then a confirmation dialog box is displayed. Tap to select "Yes" to delete the file or the folder.



## 2. Delete a File or Folder from the External Memory

- 1) Press **Storage** → **Disk** and rotate the multifunction knob  to select the external memory. Press down the knob to open it.
- 2) Rotate the multifunction knob  to select the file or the folder to be deleted.
- 3) Press **Delete**, and then a confirmation dialog box is displayed. Tap to select "Yes" to delete the file or the folder.

### Tip

- When you delete a directory where a file or a folder exists, the directory cannot be deleted.
- The touch screen function only allows you to select the directory and open it. You are unable to delete the directory with the touch screen function.



## To Copy and Paste a File or Folder

- 1) Press **Storage** → **Disk**, rotate the multifunction knob  to select the internal or external memory. Press down the knob to select it.
- 2) Rotate the multifunction knob  to select the file or folder to be copied and pasted.
- 3) Press **Copy** to copy the selected file or folder.
- 4) Select the destination disk, then press **Paste** to paste the selected file or folder.

### Tip

- If the destination directory has the same file or folder that you want to paste, then a prompt message "File or directory exists" is displayed. You are not allowed to execute the copy and paste operation.
- The touch screen function only allows you to select the directory and open it. You are unable to copy the directory with the touch screen function.

## To Rename a File or Folder

- 1) Press **Storage** → **Disk**, rotate the multifunction knob  to select the internal or external memory. Press down the knob to open it.
- 2) Rotate the multifunction knob  to select the file or folder to be renamed.
- 3) Press **Rename**, and then the filename input interface is displayed. For the filename input method, refer to descriptions in "**To Create a Folder**".

### Tip

The touch screen function only allows you to select the directory and open it. You are unable to rename the directory with the touch screen function.



## To Clear the Internal Memory Safely

- 1) Press **Storage** → **Disk**, rotate the multifunction knob  to select the internal memory "Local Disk(C)".
- 2) Press **SecurityClear**, and then a prompt message for confirming security clear is displayed.
- 3) Press **OK** to clear all the files stored in the internal memory.

## Factory Settings

Press **Default** on the front panel, then a prompt message "Restore default?" is displayed. Press **OK** or tap **OK** to restore the oscilloscope to the factory default settings, as shown in the table below.

Table 18-1 Factory Settings

Parameter	Factory Settings
Horizontal	
Vertical	
Acquire	
Trigger	
Display	
Dual-channel Function/AWG (GI or GII)	
Cursor	
Storage	
Utility	
Math	
Logic Analyzer (LA)	
Protocol Decoding (Decode)	
Ref	
<b>Horizontal</b>	
Horizontal Time Base	1 $\mu$ s
Horizontal Position	0 s
Delayed Sweep	Off
Timebase Mode	YT
Fine	Off
Horizontal Expansion	Center
<b>Vertical</b>	
Vertical Scale	100 mV
Vertical Offset	0 V
CH1	On

CH2	On
CH3	On
CH4	On
Channel Coupling	DC
BW Limit	Off
Attenuation	1X
Input Impedance	1 M $\Omega$
Invert	Off
Fine	Off
Channel Unit	[V]
Display Label	Off
Ch-Ch Skew	0 s
Offset Cal	0 V
<b>Acquire</b>	
Acquisition Mode	Normal
Memory Depth	Auto
Anti-Aliasing	Off
<b>Trigger</b>	
Trigger Type	Edge Trigger
Source Selection	CH1
Edge Type	Rising
Trigger Mode	Auto
Trigger Coupling	DC
Trigger Holdoff	16 ns
Noise Rejection	Off
<b>Display</b>	
Display Type	Vector
Persistence Time	Min
Intensity	60%
Grid	FULL
Brightness	20%
Show Scale	Off
Color Grade	Off
Waveform Freeze	On
Screen Saver	Off
<b>Dual-channel Function/AWG (GI or GII) <sup>[1]</sup></b>	
GI	Off
GII	Off
Status Display	Off
<b>GI/GII</b>	

Wave	Sine
Output	Off
Frequency	1 kHz
Amplitude	1 V
Offset	0 V
Start Phase	0°
Setting Type	Off
Impedance	HighZ
<b>Cursor</b>	
Mode	Off
<b>Manual</b>	
Select	Y
Source	CH1
AY	100 mV
BY	-100 mV
Vertical Unit	Source
Hori. Unit	s
Region	Main
<b>Track</b>	
AX Source	CH1
BX Source	CH1
AX	-1 $\mu$ s
BX	1 $\mu$ s
Track	X
<b>XY</b>	
AX	-233.3 mV
BX	100 mV
AY	-233.3 mV
BY	-100 mV
<b>Measure</b>	
Indicator	Off
<b>Storage</b>	
Auto Name	ON
Header	ON
<b>Save Image</b>	
Format	*.png
Invert	OFF
Color	Color
Window	Show
<b>Save Wave</b>	
Data Source	Screen
Format	*.bin

Window	Show
<b>Save Setup</b>	
File Type	*.stp
Window	Show
<b>Load Wave</b>	
File Type	*.wfm
<b>Load Setup</b>	
File Type	*.stp
<b>Disk</b>	
File Type	*.*
<b>Utility</b>	
Sound	OFF
<b>PassFail</b>	
Enable	OFF
Source	CH1
Operate	Stop
Range	Screen
X Mask	0.24 div
Y Mask	0.48 div
File Type	*.pf
File Type	*.pf
File Name	RigolDS0
Window	Show
Indicator	OFF
Aux Output	OFF
Output Event	Fail
Polarity	Positive
Pulse	1 $\mu$ s
Err Action	None
<b>Record</b>	
Record	OFF
Record	<input type="radio"/>
Play	<input type="checkbox"/>
<b>Record</b>	
Interval	10 ns
Frames	1000
Max Frames	9175
Beeper	<input type="checkbox"/>
Current	0
<b>Play</b>	
Mode	<input type="checkbox"/>
Sequence	<input type="checkbox"/>
Interval	10 ns

Current	0
Jump To	First 
<b>Save</b>	
First	1
<b>System</b>	
Power On	Default
Power Status	Switch On
AUX Out	TrigOut
Key Locker	Unlocked
HDMI Output	OFF
HDMI Resolution	1280x720
<b>SelfCal</b>	
Window	Open
<b>Auto Config</b>	
Peak to Peak	OFF
CH	All
Overlay	OFF
Coupling	OFF
<b>Printer</b>	
Copies	1
Paper Size	A4
Ink Saver	ON
Printer	HP/Laserjet
<b>Email</b>	
Attachment	Screen
<b>Quick Settings</b>	
Operation	Save Image
Format	*.png
Invert	OFF
Color	Color
<b>Math</b>	
Invert	OFF
Expand	GND
Display Label	OFF
Library	ADD
Label Editing	ADD
<b>A+B</b>	
Operation	OFF
SourceA	CH1
SourceB	CH1
Offset	0 V
Scale	500 mV
<b>A-B</b>	



Operation	OFF
SourceA	CH1
SourceB	CH1
Offset	0 V
Scale	10 uV
<b>A×B</b>	
Operation	OFF
SourceA	CH1
SourceB	CH1
Offset	0 U
Scale	500 uU
Operation	OFF
SourceA	CH1
SourceB	CH1
Offset	0 U
Scale	500 mU
<b>FFT</b>	
Operation	OFF
Source	CH1
Offset	0 dB
Scale	1 dB
Unit	dB/dBV
X	Start-End
Start Freq	0 Hz
Stop Freq	10 MHz
Window Function	Hanning
Mode	Trace
View	Full
Peak Search	OFF
Peak Number	5
Threshold	5.5 dB
Excursion	1.8 dB
Table Order	Amp Order
<b>A&amp;&amp;B</b>	
Operation	OFF
SourceA	CH1
SourceB	CH1
Wave Size	Medium
Thre.CH1	0 V
Thre.CH2	0 V
Thre.CH3	0 V
Thre.CH4	0 V
Sensitivity	0.3 Div

<b>A  B</b>	
Operation	OFF
SourceA	CH1
SourceB	CH1
Wave Size	Medium
Thre.CH1	0 V
Thre.CH2	0 V
Thre.CH3	0 V
Thre.CH4	0 V
Sensitivity	0.3 Div
<b>A^B</b>	
Operation	OFF
SourceA	CH1
SourceB	CH1
Wave Size	Medium
Thre.CH1	0 V
Thre.CH2	0 V
Thre.CH3	0 V
Thre.CH4	0 V
Sensitivity	0.3 Div
<b>!A</b>	
Operation	OFF
SourceA	CH1
Wave Size	Medium
Thre.CH1	0 V
Thre.CH2	0 V
Thre.CH3	0 V
Thre.CH4	0 V
Sensitivity	0.3 Div
<b>Intg</b>	
Operation	OFF
Source	CH1
Offset	0 v*s
Scale	500 nv*s
Bias	0
Invert	OFF
<b>Diff</b>	
Operation	OFF
Source	CH1
Offset	0 v/s
Scale	2 Mv/s
Smooth	5
Invert	OFF
<b>Sqrt</b>	

Operation	OFF
Source	CH1
Offset	0 U
Scale	100 mU
Invert	OFF
<b>Lg</b>	
Operation	OFF
Source	CH1
Offset	0 U
Scale	1 U
Invert	OFF
<b>Ln</b>	
Operation	OFF
Source	CH1
Offset	0 U
Scale	2 U
Invert	OFF
<b>Exp</b>	
Operation	OFF
Source	CH1
Offset	0 U
Scale	1 U
Invert	OFF
<b>Abs</b>	
Operation	OFF
Source	CH1
Offset	0 U
Scale	20 mV
Invert	OFF
<b>Low Pass</b>	
Operation	OFF
Source	CH1
Offset	0 V
Scale	20 mV
$\omega_c$	6.25 MHz
Invert	OFF
<b>High Pass</b>	
Operation	OFF
Source	CH1
Offset	0 V
Scale	20 mV
$\omega_c$	6.25 MHz
Invert	OFF
<b>Band Pass</b>	



Operation	OFF
Source	CH1
Offset	0 V
Scale	20 mV
$\omega$ c1	6.25 MHz
$\omega$ c1	12.5 MHz
Invert	OFF
<b>Band Stop</b>	
Operation	OFF
Source	CH1
Offset	0 V
Scale	20 mV
$\omega$ c1	6.25 MHz
$\omega$ c1	12.5 MHz
Invert	OFF
<b>AX+B</b>	
Operation	OFF
Source	CH1
Offset	0 V
Scale	20 mV
A	0
B	0
Invert	OFF
<b>Logic Analyzer (LA)</b>	
Select	None
D7-D0	OFF
D15-D8	OFF
Wave Size	Medium
Arrange	D15-D0
<b>Threshold</b>	
D7-D0	1.4 V
D15-D8	1.4 V
<b>Label</b>	
Display	OFF
Select	D0
Label	D0
<b>Protocol Decoding (Decode)</b>	
Bus Type	Parallel
Bus Status	OFF
Format	Hex
Label	ON
Event Table	OFF
Noise Reject	OFF

Clock	OFF
<b>RS232</b>	
Bus Status	OFF
Baud	9.6 kbps
Tx	CH1
Threshold	0 V
Rx	OFF
Polarity	
Endian	LSB
Data	8 bits
Stop Bit	1 bit
Parity	None
Package	OFF
Separator	0(NUT)
<b>I2C</b>	
Bus Status	OFF
Clock	CH1
SCL Thre	0 V
SDA	CH2
SDA Thre	0 V
Exchange	SCL/SDA
R/W	Without
<b>SPI</b>	
Bus Status	OFF
Mode	Timeout
Timeout	1 $\mu$ s
CLK	CH1
Threshold	0 V
Slope	Rising
MISO	CH2
Threshold	0 V
MOSI	OFF
Polarity	
Width	8
Endian	MSB
<b>LIN</b>	
Bus Status	OFF
Source	CH1
Threshold	0 V
Baud	19.2 kbps
Parity	Without
Version	1.X
<b>CAN</b>	
Bus Status	OFF

Source	CH1
Threshold	0 V
Signal	CAN_L
Baud	1 Mbps
Sample Position	50%
<b>FlexRay</b>	
Bus Status	OFF
Source	CH1
Threshold	0 V
Channel Selection	A
Baud	10 Mbps
Signal	BP
Sample Position	50%
<b>I2S</b>	
Bus Status	OFF
SCLK	CH1
SCLK Thre	0 V
SCLK Edge	Rising
WS	CH2
SCLK Thre	0 V
Data	CH3
Data Thre	0 V
Word Size	4
Receive	4
Alignment	I2S
WS Low	Left
Endian	MSB
Data Polarity	
<b>1553B</b>	
Bus Status	OFF
Data	CH1
Threshold	0 V
<b>Ref</b>	
Current	Ref1
Source	CH1
VScale	0 V
VOffset	1 V
Color	Gray
Label Display	OFF
Library	Default
Label	REF1

**Note**<sup>[1]</sup>: It is only available for the model installed with the MSO5000-AWG option.

**Note**<sup>[2]</sup>: PLA2216 active logic probe option is required to be ordered.

# Chapter 19 System Utility Function Setting

In the system function setting menu, you can set the parameters for the remote interface and the system-related parameters.

Contents in this chapter:

- Remote Interface Configuration
- System-related

## Remote Interface Configuration

M505000 series can communicate with the PC via the USB, LAN, or GPIB (requiring to work with **RIGOL's** USB-GPIB interface converter) interface. Before using the remote interfaces, configure the corresponding interface according to the introductions in the following section.

### LAN Configuration

Before using the LAN bus, use a network cable to connect the oscilloscope to your local area network. The network interface of the oscilloscope is on the rear panel.

Press **Utility** → **IO** → **LAN** to open the LAN Settings interface, as shown in the following figure. You can view the current network settings and configure the network parameters.

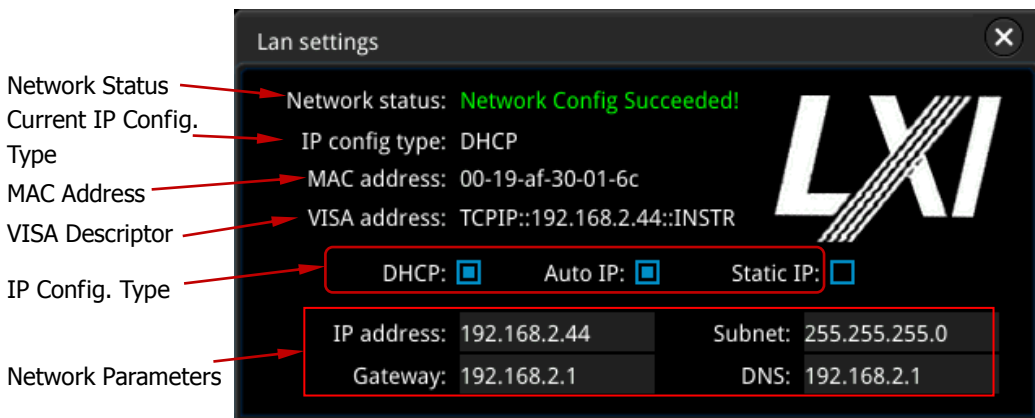

Figure 19-1 Network Connection Setting Interface

### Network Status

Different prompts will be displayed according to the current network connection status.



- Network Config Succeeded!
- Acquiring IP...
- IP Conflict!
- Disconnected!
- DHCP Config Failed!
- Read Status Fail!
- Connected!

- Invalid IP!
- IP lost!
- Please wait...



## IP Configuration Type

The configuration type of the IP address can be DHCP, Auto IP, or Static IP. For different IP configuration types, the configurations for IP address and other network parameters are different.



### DHCP

Press **IP Config Type**, then rotate the multi-function knob  or press **IP Config Type** continuously to select "DHCP". Press down the knob  to select it. You can also enable the touch screen to select it. When DHCP is valid, the DHCP server in the current network will assign the network parameters (e.g. IP address, Subnet, Gateway, and DNS) for the oscilloscope.

### Auto IP

Press **IP Config Type**, then rotate the multi-function knob  or press **IP Config Type** continuously to select "Auto IP". Press down the knob  to select it. You can also enable the touch screen to select it. In auto IP mode, the oscilloscope will get the IP address (ranging from 169.254.0.1 to 169.254.255.254) and the subnet mask (255.255.0.0) automatically according to the current network configuration. Only when "DHCP" is not selected or failed to be connected, can "Auto IP" be valid.

### Static IP

Press **IP Config Type**, then rotate the multi-function knob  or press **IP Config Type** continuously to select "Static IP". Press down the knob  to select it. You can also enable the touch screen to select it. When this type is valid, disable DHCP and Auto IP manually, then "IP", "SubMask", "Gateway", and "DNS" are added to the menu. At this time, you can self-define the network parameters (e.g. IP address) of the oscilloscope.

#### 1. Set IP Address

The format of the IP address is nnn.nnn.nnn.nnn. The range of the first segment (nnn) of the address is from 0 to 255 (except 127); wherein, the valid range is from 0 to 223. The range for the other three segments is from 0 to 255. You are recommended to ask your network administrator for an IP address available.

Press **IP**, and then the numeric keypad is displayed. Use the numeric keys to

input the desired IP address. This setting will be saved to the non-volatile memory; if "Power On" is set to "Last", then DHCP and Auto IP are disabled at the next power-on. The oscilloscope will load the preset IP address automatically.

## 2. Set the Subnet Mask

The format of the subnet mask is nnn.nnn.nnn.nnn; wherein, the range of "nnn" is from 0 to 255. You are recommended to ask your network administrator for a subnet mask available.

Press **SubMask**, and then the numeric keypad is displayed. Use the numeric keys to input the desired subnet mask. This setting will be saved in the non-volatile memory; if "Power On" is set to "Last", then DHCP and Auto IP are disabled at the next power-on. The oscilloscope will load the preset subnet mask automatically.

## 3. Set the Gateway

You can set this parameter in Static IP mode.

The format of the gateway is nnn.nnn.nnn.nnn. The range of the first segment (nnn) is from 0 to 223 (except 127), and the range for the other three segments is from 0 to 255. You are recommended to ask your network administrator for a gate address available.

Press **Gateway**, and then the numeric keypad is displayed. Use the numeric keys to input the desired subnet mask. This setting will be saved in the non-volatile memory; if "Power On" is set to "Last", then DHCP and Auto IP are disabled at the next power-on. The oscilloscope will load the preset gateway automatically.

## 4. Set the DNS

You can set this parameter in Static IP mode.

The format of the DNS address is "nnn.nnn.nnn.nnn". The range for the first segment (nnn) of the address is from 0 to 223 (except 127); and the range for the other three segments is from 0 to 255. You are recommended to ask your network administrator for an address available.

Press **DNS**, and then the numeric keypad is displayed. Use the numeric keys to input the desired DNS address. Generally, you do not need to set the DNS, therefore this parameter setting can be ignored.



**Tip**

- When the three IP configuration types are all turned on, the priority of the parameter configuration from high to low is "DHCP", "Auto IP", and "Static IP".
- The three IP configuration types cannot be all turned off at the same time.

## Apply the Network Parameter Setting

Press **Apply** to apply the current network parameter setting.

## MAC address

For each oscilloscope, the MAC address is unique. When assigning the IP address for the oscilloscope, the system uses the MAC address to identify the instrument.

## VISA Address

Displays the VISA address currently used by the oscilloscope.

## To Set mDNS

Press **mDNS** continuously to enable or disable the multicast Domain Name System (mDNS). This system is used to provide the function of DNS server for service discovery in a small network without a DNS server.

## To Set HDMI

Sets the status and parameters of the HDMI video output interface on the rear panel. Note that only when the HDMI interface is connected, can this menu be enabled.

Press **HDMI** to enter the HDMI setting menu.

- Press **Output** continuously to enable or disable the video output.
  - ON: You can connect the instrument to an external display via this interface to better observe the waveform display clearly from the external display.
  - OFF: disables the interface.
- Press **Resolution** to set the screen resolution. The available resolution includes 640x480, 720x480, and 1280x720.

## To Set the GPIB Address

Before using the GPIB bus to control the oscilloscope, use the USB-GPIB interface converter (an option that requires to be ordered separately) to extend the GPIB interface, and then use the GPIB cable to connect the instrument to the PC. Press **Utility** → **IO** → **GPIB**, then rotate the multifunction knob  directly to set the GPIB address or use the pop-up numeric keypad to input the GPIB address. Its settable range is from 1 to 30. By default, it is 1.

## USB Connection



The oscilloscope can communicate with a PC via the USB DEVICE interface on the rear panel. No parameters are required to be configured.

## System-related

### Beeper



When the beeper is enabled, you can hear the sound of the beeper when you perform the following operations:

- Press a key or a menu key on the front panel
- Enable the touch screen
- When a prompt message is displayed

Press **Utility** and then press **Beeper** continuously to select "ON" () or "OFF" (). By default, it is OFF.

### Language

This oscilloscope supports menus in multiple languages. Both Chinese and English are available for the display of the help information, prompt messages, and interface.

Press **Utility** → **Language** and rotate the multi-function knob  to select the desired language; then, press down the knob  to select the language. You can also press **Language** continuously to select the language or enable the touch screen to tap the desired language and select it.

### System Information

Press **Utility** → **System** → **About** to view the system information of the oscilloscope, including the manufacturer, product model, serial number, etc.

Besides, you can also press **About** to view the system information of the oscilloscope in the "Help" system menu.

### Power On

You can set the system configuration to be recalled when the oscilloscope is powered on again after power-off.

Press **Utility** → **System**, and then press **Power On** continuously to select "Last" or "Default". By default, it is "Last".

- Last: returns to the setting of the system at last power-off.
- Default: returns to the factory setting of the system.

## Aux Output

You can set the type of the signal output from the **[TRIG OUT]** connector on the rear panel.

Press **Utility** → **System**, and then press the **AUX Out** key continuously to select "TrigOut" or "PassFail".

- **Trigger Output**

After this type is selected, at each trigger (hardware trigger), the oscilloscope outputs a signal from the **[TRIG OUT]** connector on the rear panel that can reflect the current capture rate of the oscilloscope. Connect this signal to a waveform display device, measure the signal frequency. It is found that the measurement result is the same as the current capture rate.

- **Pass/Fail**

When this type is selected, the instrument can output a positive or negative pulse via the **[TRIG OUT]** connector when a successful or failed event is detected. Refer to descriptions in "**To Set the Output Form of the Test Results**". When you enable the Aux output, the **AUX Out** menu is automatically set to "PassFail". When the **AUX Out** menu is automatically set to "TrigOut", then in the pass/fail test menu, the Aux Out function is automatically disabled.

## Help

Press **Utility** → **System** → **Help** to enter the "Help" function menu. You can also enable the touch screen and then tap the function navigation icon  at the lower-left corner of the screen to open the function navigation. Then, tap the "Help" icon to open the "Help" function menu.

- Press **About** to view the system information of the oscilloscope.
- Press **Help** to enter the built-in help system.
- Press **Option list** to view the name of the installed option and other detailed information about the option from the option list.
- Press **Option install** to install the desired option. For detailed installation procedures, refer to descriptions in "**To View the Option Information and the Option Installation**".
- Press **Online upgrade** to perform online upgrading for the system software.
- Press **Local upgrade** to perform local upgrading for the system software.

## Self-calibration

The self-calibration program can quickly make the oscilloscope to work in an optimal state to get the precise measurement results. You can perform self-calibration at any time, especially when the changes of the ambient temperature reach or above 5°C. Make sure that the oscilloscope has been warmed up or operating for more than 30 minutes before the self-calibration.

Disconnect all the input channels, then press **Utility** → **System** → **SelfCal**, and the self-calibration interface is displayed, as shown in the following figure.



Figure 19-2 Self-calibration Interface

- Press **Start**, and then the oscilloscope will start to execute the self-calibration program.
- After the self-calibration program is launched, the **Exit** menu is no longer grayed out and is enabled. Press **Exit** to give up the self-calibration operation at any time.
- Press **Window** continuously to open or close the self-calibration information window. You can also enable the touch screen to tap the **X** icon at the upper-right corner of the self-calibration information window to close the window.

**Note:** Most of the keys are disabled during the self-calibration.

## Auto Config

You can set the parameters for the **AUTO** menu.

Press **Utility** → **More** → **Auto Config**, and set the parameters for the **AUTO** key.

For detailed settings, refer to descriptions in "**Quick Measurement after AUTO**".

## Print Setting

Connect the oscilloscope to the local area network via the network cable. The MSO5000 series supports printing the whole screen to the USB printer or network printer. You can connect the oscilloscope to the printer directly via the USB DEVICE interface on the rear panel. Then, you can set the print parameters on the oscilloscope to control the printer to output the corresponding picture.

Press **Utility** → **More** → **Printer** to enter the printer setting menu. After the printer is properly connected, you need to set the network configurations for printing, and then set the printer parameters.



### 1. Network Configuration

Press **Setting** to enter the network configuration menu.

- **Select the Printer**

Press **Printer**, and rotate the multifunction knob  to select the printer model. Press down the knob to select it. You can also press **Printer** continuously or enable the touch screen to select it.

- **Set the IP Address**

Press **Printer IP**, then rotate the multifunction knob  to set each segment of the IP address for the printer. Press down the knob to confirm the setting for each segment of the address. At this time, the cursor is moved to the next segment automatically. You can also press **Printer IP** continuously to switch the segment position, and then rotate the multifunction knob  to set it. You can also enable the touch screen to switch the address segment.

- **Set the Port**

Press **Printer Port**, rotate the multifunction knob  to adjust the port number or use the pop-up numeric keypad to input the port number.

- **Network Test**

Press **Test** to test whether the network is connected. If connected, a prompt message "Network connected" is displayed.

- **Print Test Page**

Press **Print test page** to carry out the print test. The print progress is also displayed on the screen.

### 2. Set the Printer Parameters

- **Print**

After the printer parameters are set, press **Print** to execute the print

operation.

- **Copies**

Press **Copies**, then rotate the multifunction knob  to set the number of copies to be printed or use the pop-up numeric keypad to set it. The settable range is from 1 to 99.

- **Paper Size**

The **Paper Size** menu is grayed out and disabled. The paper size supported by the oscilloscope is only A4.

- **Ink Saver**

Press **Ink Saver** continuously to enable or disable the ink saver setting. If disabled, you need to set **Color**. Press **Color** continuously to select "Gray" or "Color".

## Email

This oscilloscope supports sending files via emails. Press **Utility** → **More** → **Email** to enter the email setting menu.

### 1. Set the Email Server

Press **Settings** to enter the email server login setting menu. The following window is displayed. After the setting, enable the touch screen to tap **OK** to complete the server login. To cancel login, tap **Cancel** to exit or tap the icon  at the upper-right corner of the window to exit. If you exit the server setting window, you can press **SMTP**, **Port**, **UserName**, or **PassWord** to reopen the window.

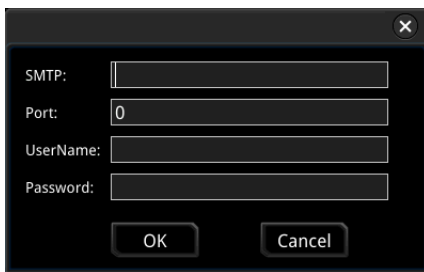

The screenshot shows a dialog box for email server settings. It has a dark background and a close button (X) in the top right corner. The fields are: SMTP: [empty], Port: 0, UserName: [empty], Password: [empty]. At the bottom, there are two buttons: OK and Cancel.

- **Set SMTP**

Press **SMTP** to set the mail transmission protocol. For detailed settings of mail transmission protocol, refer to descriptions in **"To Create a Folder"**.

- **Set the port**

Press **Port** to set the protocol port in the pop-up numeric keypad. Its range



is from 0 to 65535.

- **Set the user name**  
Press **UserName** to set the user name of the server. For detailed setting methods for the user name, refer to descriptions in "**To Create a Folder**".
- **Set the password**  
Press **PassWord** to set the password of the server. For detailed setting methods for the password, refer to descriptions in "**To Create a Folder**".
- **Email test**  
Press **Test** to test whether the e-mail server is properly set.
- **Restore default settings**  
Press **Default** to restore the settings of receiver and mail settings to defaults.

## 2. Set the Receiver

Press **Receiver** to display the receiver input interface, and you can edit the email address of the receiver. For detailed input methods of the receiver email address, refer to descriptions in "**To Create a Folder**".

## 3. Upload Attachment

Press **Attachment**, then rotate the multifunction knob  to select the attachment type to be uploaded, and then press down the knob  to select it. You can also press **Attachment** continuously to select or enable the touch screen to tap the attachment. The available attachments include "Screen", "Setup", and "Other". If you select "Other", you also need to press **File Select** to select the file to be uploaded.

## 4. Send the Mail

Press **Send Mail** to send the edited email to the receiver.

## Key Locker

You can set whether to lock the front-panel keys.

Press **Utility** → **System**, and press **Key Locker** continuously to select "Locked" or "Unlocked".

- Locked: indicates that all keys of the oscilloscope (except the **Key Locker** key) are locked.
- Unlocked: unlocks the front-panel keys.



## Quick Operation

You can set the shortcut functions for the **Quick** key on the front panel.

Press **Utility** → **More** → **Quick settings** to enter the quick key setting menu. You can also enable the touch screen and then tap the function navigation icon  at the lower-left corner of the screen to open the function navigation. Then, tap the "Quick" icon to open the quick key setting menu.

The Quick shortcut key includes the following five functions:

### 1. Image Saving

When the Quick shortcut key is set to "Save Image", press **Quick** on the front panel to capture the screen.

- **Operation Type**

Press **Operation** and then rotate the multifunction knob  to select "Save Image". Press down the knob to select it. You can also press **Operation** continuously to select among the options, or enable the touch screen to tap the desired operation type.

- **Image Format**

Press **Format** and then rotate the multifunction knob  to select the image format. You can also press **Format** continuously to select among the options, or enable the touch screen to tap the desired image format. The image formats include "\*.png", "\*.bmp", "\*.jpg", and "\*.tif".

- **Invert**

Press **Invert** continuously to enable or disable the invert function.

- **Color**

Press **Color** continuously to set the color of the saved image to "Color" or "Gray".

### 2. Waveform Saving

When the Quick shortcut key is set to "Save Wave", press **Quick** on the front panel to save the waveform.

- **Operation Type**

Press **Operation** and then rotate the multifunction knob  to select "Save Wave". Press down the knob to select it. You can also press **Operation** continuously to select among the options, or enable the touch screen to tap the desired operation type.

- **Data Source**

Press **Data Source** continuously to select "Memory" or "Screen" as the source of the saved waveform.

- **Format**

Press **Format** and then rotate the multifunction knob  to select the waveform format. Press down the knob to select it. You can also press **Format** continuously to select or enable the touch screen to tap the format. The format types include "\*.bin" and "\*.csv".

- **Storage Channel**

If "Memory" is selected under **Data Source**, you need to set the storage channel. Press **Channel** and then rotate the multifunction knob  to select the storage channel. You can also press **Channel** continuously to select the channel or enable the touch screen to tap the desired channel. The available storage channels include CH1-CH4 and D0-D15.

### 3. Setup Saving

When the Quick shortcut key is set to "Save Setup", press **Quick** on the front panel to save the setup of the oscilloscope.

Press **Operation** and then rotate the multifunction knob  to select "Save Setup". Press down the knob to select it. You can also press **Operation** continuously to select among the options, or enable the touch screen to tap the desired operation type. You do not need to set relevant parameters.

### 4. All Measurement

When the Quick shortcut key is set to "All Measure", press **Quick** on the front panel to measure all the parameters of the current measurement source.

- **Operation Type**

Press **Operation** and then rotate the multifunction knob  to select "All Measure". Press down the knob to select it. You can also press **Operation** continuously to select among the options, or enable the touch screen to tap the desired operation type.

- **All Measurement**

Press **All Measure**, then rotate the multifunction knob  to select the desired measurement channel. You can also press **All Measure** continuously to select or enable the touch screen to tap the desired channel. The available measurement channels include OFF and CH1-CH4.

### 5. Statistics Reset

When the Quick shortcut key is set to "Stat Reset", press **Quick** on the front panel to make statistics reset of measurement or pass/fail test reset.

- **Operation Type**

Press **Operation** and then rotate the multifunction knob  to select "Stat Reset". Press down the knob to select it. You can also press **Operation** continuously to select among the options, or enable the touch screen to tap the desired operation type.

- **Statistics Reset**

Press **Stat Reset** and then rotate the multifunction knob  to select the function that requires statistics reset. Press down the knob to select it. You can also press **Stat Reset** continuously to select among the options, or enable the touch screen to tap the desired option. You can select "Measure" or "PassFail".

## 6. Print

When the Quick shortcut key is set to "Print", press **Quick** on the front panel to print the screen image of the oscilloscope.

Press **Operation** and then rotate the multifunction knob  to select "Print". Press down the knob to select it. You can also press **Operation** continuously to select among the options, or enable the touch screen to tap the desired operation type.

## 7. Email

When the Quick shortcut key is set to "Email", press **Quick** on the front panel to send the file through email.

Press **Operation** and then rotate the multifunction knob  to select "Email". Press down the knob to select it. You can also press **Operation** continuously to select among the options, or enable the touch screen to tap the desired operation type.

## 8. Record

When the Quick shortcut key is set to "Record", press **Quick** on the front panel to record the waveform.



Press **Operation** and then rotate the multifunction knob  to select "Record". Press down the knob to select it. You can also press **Operation** continuously to select among the options, or enable the touch screen to tap the desired operation type.

## 9. Save Group

When the Quick shortcut key is set to "Save Group", set the **Group** parameter. Press **Quick** on the front panel to save the group.

Press **Operation** and then rotate the multifunction knob  to select "Save

Group". Press down the knob to select it. You can also press **Operation** continuously to select among the options, or enable the touch screen to tap the desired operation type.

Set the **Group** parameter: press **Group** and then rotate the multifunction knob  to select "Save Image", "Save Wave", or "Save Setup". Press down the knob to select the desired one. You can also press **Group** continuously or enable the touch screen to select it. You can select any or all of the three items. The sign  indicates that the item has been selected, and  indicates that the item has not been selected.

## Self-check

The oscilloscope supports a variety of self-check functions, including key test, screen test, and touch test.

Press **Utility** → **More** → **Self Check** to enter the self-check menu.

### 1. Key Test

Press **Key Test** to enter the keyboard test interface (virtual keypad of the front panel). At this time, you can press the keys on the front panel to check whether the virtual keys are highlighted. If yes, it indicates that the keys work normally; if no, it indicates that there's something wrong with the keys. Press **RUN/STOP** for three consecutive times to exit the keyboard test interface.

### 2. Screen Test

Press **Screen Test** to enter the screen test interface and check whether the defective pixel exists. There are 24 screen test interfaces. Press **SINGLE** to switch to the next screen test interface. Press **RUN/STOP** for three consecutive times to exit the screen test interface.

### 3. Touch Test

Press **Touch Test** to enter the touch screen test interface first, as shown in the figure below. Slide with your finger on the screen. If there is a line displaying at the empty area where you slide on the screen and the box that you tap turns out to be filled with green background, it indicates that the touch function of this area is normal.

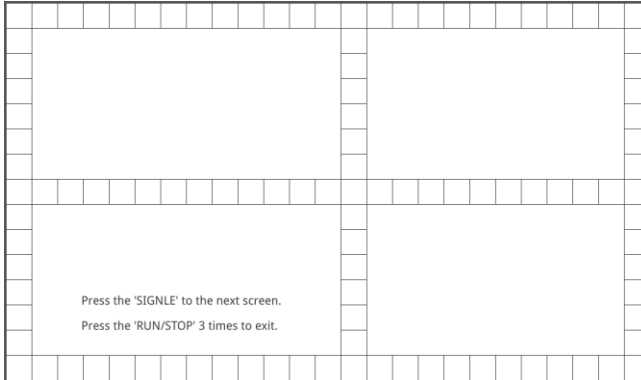

The press **SINGLE** to switch to the next touch screen test interface, as shown in the figure below. At this time, you can pinch or stretch the **RIGOL** logo on the screen to zoom it out or in to check whether the gestures work normally. Press **RUN/STOP** for three consecutive times to exit the touch screen test interface.







## System Time

The system time is displayed at the lower-right side of the screen in "hh:mm (hour:minute)" format. When you save the waveform, the output file will contain the time information.

Press **Utility** → **More** → **Time** to open the time setting menu.

### 1. Set the System Time

- (1) Press **Show Time** to open or close the system time interface.
- (2) Set "year": Press **Year**, rotate the multifunction knob  directly to set it or use the pop-up numeric keypad to input the numeric value to set it.
- (3) Set "month": Press **Month**, rotate the multifunction knob  directly to set it or use the pop-up numeric keypad to input the numeric value to set it.

- (4) Set "day": Press **Day**, rotate the multifunction knob  directly to set it or use the pop-up numeric keypad to input the numeric value to set it.
- (5) Set "Hour": Press **Hour**, rotate the multifunction knob  directly to set it or use the pop-up numeric keypad to input the numeric value to set it.
- (6) Set "Minute": Press **Minute**, rotate the multifunction knob  directly to set it or use the pop-up numeric keypad to input the numeric value to set it.

The setting range of each item of the system time conforms to the convention.

- Year: 2017 to 2099
- Month: 01 to 12
- Date: 01 to 31 (28, 29, or 30)
- Hour: 00 to 23
- Minute: 00 to 59
- Second: 00 to 59

## 2. Apply the Currently Set System Time

Press **Apply** to validate the current settings. The time at the lower-right side of the screen will be updated.

# Chapter 20 Remote Control

The oscilloscope can be remotely controlled in the following three methods:

## User-defined programming

You can program and control the oscilloscope by using the SCPI (Standard Commands for Programmable Instruments) commands. For details about the relevant commands and programming, refer to *MSO5000 Series Programming Guide*.

## PC software

You can use the PC software to send commands to control the oscilloscope remotely. **RIGOL** Ultra Sigma is recommended. You can download the software from **RIGOL** official website ([www.rigol.com](http://www.rigol.com)).

## Operation Procedures:

- (1) Set up communication between the instrument and PC.
- (2) Run Ultra Sigma and search for the instrument resource.
- (3) Open the remote command control panel to send commands.

## Web Control

MSO5000 series digital oscilloscope supports Web Control. When the instrument is connected to the internet, Web Control can display the waveform interface of the oscilloscope in a real-time manner. You can migrate the instrument control and waveform analysis to the control terminals (e.g. PC, mobile, and iPad) through Web Control to realize remote control of the instrument. When you log in to the Web Control for the first time, use the user name "admin" (without quotation marks) and the password "rigol" (without quotation marks).

The oscilloscope can communicate with the PC via the following interfaces:

- Remote Control via USB
- Remote Control via LAN
- Remote Control via GPIB

This chapter will illustrate how to use **RIGOL**'s Ultra Sigma software to remotely control the oscilloscope via various interfaces.



### CAUTION

Before setting up communication, please turn off the instrument to avoid causing damage to the communication interfaces.

## Remote Control via USB

### 1. Connect the device

Use a USB cable to connect the oscilloscope (USB DEVICE interface) with the PC (USB HOST interface).

### 2. Install the USB driver

This oscilloscope is a USB-TMC device. After you connect the oscilloscope to the PC properly and power it on for the first time (the oscilloscope will be automatically configured with the USB interface). In this case, "Found New Hardware Wizard" dialog box appears on the PC. Please install "USB Test and Measurement Device (IVI)" according to the instructions. The steps are as follows:

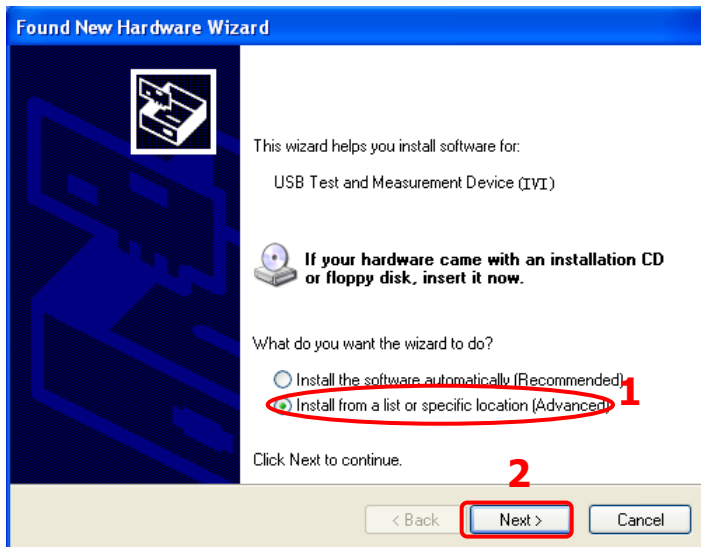



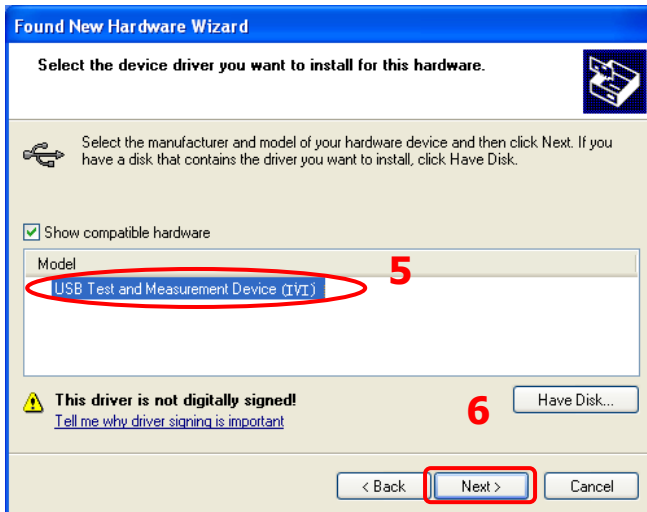
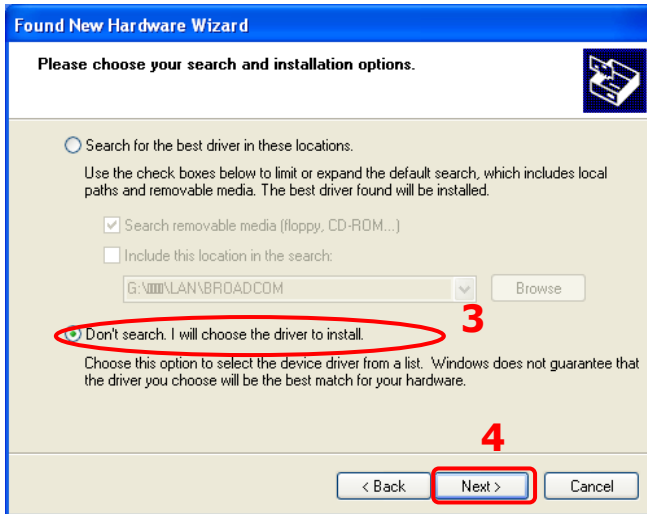

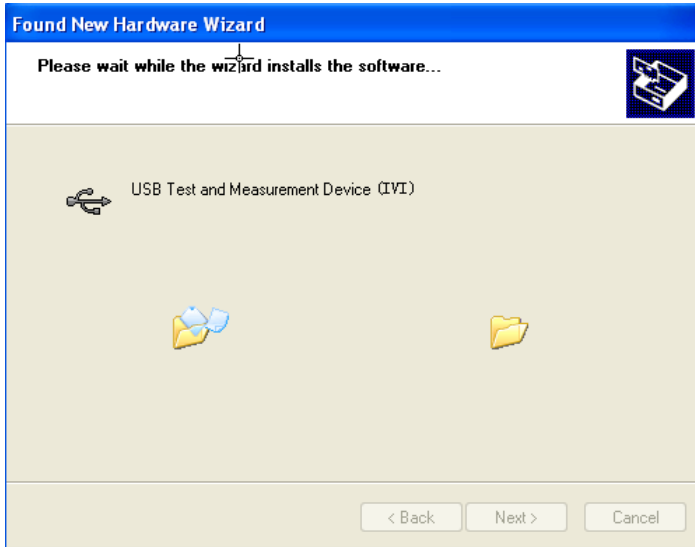

**3. Search for the device resource**

Start up Ultra Sigma and the software will automatically search for the resource currently connected to the PC via the USB interface. You can also click **USB-TMC** to search for the resource.

**4. View the device resource**

The searched instrument resource will be under the directory of "RIGOL Online Resource", with the model of the instrument and the USB interface information being displayed as follows.

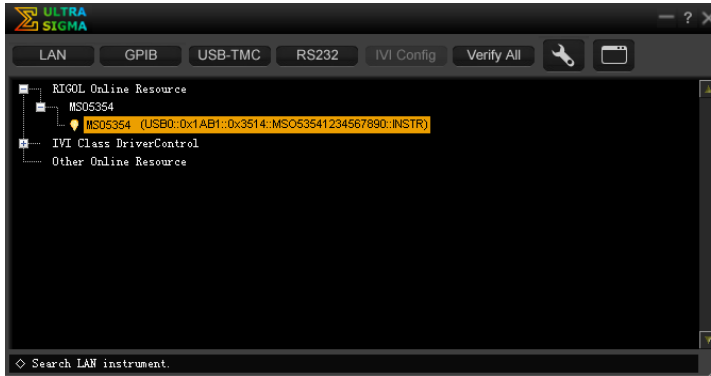

### 5. Control the instrument remotely

Right-click the resource name "MSO5354

(USB0::0x1AB1::0x3514::MSO53541234567890::INSTR)" and select "SCPI

Panel Control" to turn on the remote command control panel, through which you can send commands and read data.

## Remote Control via LAN

### 1. Connect the device

Use the network cable to connect the oscilloscope to your local area network (LAN).

### 2. Configure network parameters

Configure the network parameters of the oscilloscope according to "LAN Configuration".

### 3. Search for the device resource

Start up Ultra Sigma and click **LAN** to open the panel as shown in the figure below. Click **Search** and the software searches for the instrument resource currently connected to LAN. The resource found is displayed at the right of the panel. Click **OK** to add it.

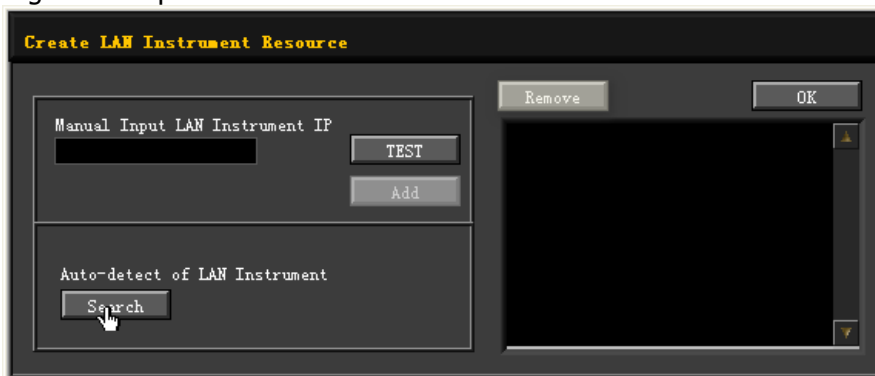

### 4. View the device resource

The resources found will appear under the "RIGOL Online Resource" directory. For example, MSO5354 (TCPIP::172.16.3.14::INSTR).

### 5. Control the instrument remotely

Right-click the resource name "MSO5354 (TCPIP::172.16.3.14::INSTR)" and select "SCPI Panel Control" to turn on the remote command control panel, through which you can send commands and read data.

### 6. Load LXI webpage

As this oscilloscope conforms to LXI CORE 2011 DEVICE standards, you can load LXI webpage through Ultra Sigma (right-click the instrument resource and select "LXI-Web"). Various important information about the instrument (including the model, manufacturer, serial number, description, MAC address, and IP address) will be displayed on the webpage. You can also directly input the IP address of the oscilloscope in the address bar of the PC browser to load the LXI webpage.

## Remote Control via GPIB

### 1. Connect the device

Use the USB-GPIB interface converter to extend the GPIB interface for the oscilloscope, and then use the GPIB cable to connect the oscilloscope to the PC to realize remote control.

### 2. Install the driver of GPIB card

Correctly install the driver of the GPIB card which has been connected to the PC.

### 3. To Set the GPIB Address

Set the GPIB address of the oscilloscope according to the description in "**To Set the GPIB Address**".

### 4. Search for the device resource

Start Ultra Sigma, and then click **GPIB**. A window is displayed as shown in Figure (a). Click **Search** and the software searches for the instrument resource currently connected to the PC via the GPIB interface. The resource found is displayed at the right of the window as shown in Figure (b). Click **OK** to add it.



(a)



(b)

**Note:** If you want to remove the resource, select the resource and then click **Remove** to remove it.

**If the resource cannot be searched automatically:**

- Select the GPIB card address of the PC from the drop-down box of "GPIB0:." and select the GPIB address set in the oscilloscope from the drop-down box of "0::INSTR".
- Click **TEST** to check whether the GPIB communication works normally; if not, please follow the corresponding prompt messages to handle it.

**5. View the device resource**

The searched instrument resource will be under the directory of "RIGOL Online Resource", as shown in the following figure.



**6. Control the instrument remotely**

Right-click the resource name "MSO5354 (GPIB0::18::INSTR)", and select "SCPI Panel Control" to open the remote command control panel. Then you can send commands and read data through the panel.

# Chapter 21 Troubleshooting

The commonly encountered failures of the oscilloscope and their solutions are listed below. If the following problems occur, locate and resolve the problems according to the following steps. If the problems still persist, contact **RIGOL** and provide your instrument information to us.

## 1. The instrument cannot be launched normally.

- (1) Check whether the power cord is correctly connected.
- (2) Upgrade the software.
- (3) Press **Default** on the front panel, and restore the instrument settings to its factory default settings.
- (4) Restart the instrument again.
- (5) If the problem still persists, contact **RIGOL**.

## 2. After the instrument is connected to the power source, the Power key is still not illuminated.

- (1) Check whether the fuse is blown.
- (2) If the problem still persists, contact **RIGOL**.

## 3. No waveform of the signal is displayed on the screen.

- (1) Check whether the probe is properly connected to the item under test.
- (2) Check whether there are signals generated from the item to be tested (you can connect the probe compensation output signal to the faulty channel to locate the problem, and then determine whether the channel or the item to be tested has a problem).
- (3) Resample the signal.

## 4. The display of waveform is ladder-like.

- (1) The horizontal time base might be too low. Increase the horizontal time base to improve the display effects.
- (2) If the display type is "Vector", the lines between the sample points may cause ladder-like display results. Press **Display** → **Type** to select "Dots".

## 5. The USB storage device cannot be recognized.

- (1) Check whether the USB storage device can work normally.
- (2) Make sure the USB storage device used is FAT32-format Flash storage type, as this instrument does not support hardware storage type.
- (3) Check whether the capacity of the USB storage device is too large. It is recommended that the capacity of the USB storage device should not exceed 8 GB for this oscilloscope.
- (4) Restart the instrument and insert the USB storage device to check it.
- (5) If the USB storage device still cannot work normally, please contact **RIGOL**.

**6. The touch functions cannot be used normally.**

- (1) Check whether you have enabled the touch screen. If not, please press the touch screen switch key **Touch Lock** to enable the touch screen function.
- (2) Check whether the screen or your finger is stained with oil or sweat. If yes, please clean the screen or dry your hands.
- (3) Check whether there is a strong magnetic field around the instrument. If the instrument is close to the strong magnetic field (e.g. a magnet), please move the instrument away from the magnet field.
- (4) If the problem still persists, please contact **RIGOL**.



# Chapter 22 Appendix

## Appendix A: Accessories and Options

Order Information	Order No.
<b>Model</b>	
MSO5354 (350 MHz, 8 GSa/s, 200 Mpts, 4+16 CH MSO)	MSO5354
MSO5204 (200 MHz, 8 GSa/s, 200 Mpts, 4+16 CH MSO)	MSO5204
MSO5104 (100 MHz, 8 GSa/s, 200 Mpts, 4+16 CH MSO)	MSO5104
MSO5102 (100 MHz, 8 GSa/s, 200 Mpts, 2+16 CH MSO)	MSO5102
MSO5074 (70 MHz, 8 GSa/s, 200 Mpts, 4+16 CH MSO)	MSO5074
MSO5072 (70 MHz, 8 GSa/s, 200 Mpts, 2+16 CH MSO)	MSO5072
<b>Standard Accessories</b>	
Power Cord Conforming to the Standard of the Destination Country	-
USB Cable	CB-USBA-USBB-F F-150
2 or 4 Passive Probes (350 MHz)	PVP2350
Quick Guide (hard copy)	-
<b>Optional Accessories</b>	
16 digital channels active logic probe (dedicated probe for MSO5000 series)	PLA2216
Front Panel Protection Cover	MSO5000-FPC
Rack Mount Kit	MSO5000-RM
USB-GPIB Interface Converter	USB-GPIB
Near-field Probe	NFP-3
Power Analysis Phase Difference Correction Jig	RPA246
Digital Oscilloscope Demonstration Plate	DK-DS6000
<b>Bandwidth Upgrade Option</b>	
Bandwidth Upgrades from 70 MHz to 100 MHz	MSO5000-BW0T1
Bandwidth Upgrades from 70 MHz to 200 MHz	MSO5000-BW0T2
Bandwidth Upgrades from 70 MHz to 350 MHz	MSO5000-BW0T3
Bandwidth Upgrades from 100 MHz to 200 MHz	MSO5000-BW1T2
Bandwidth Upgrades from 100 MHz to 350 MHz	MSO5000-BW1T3
Bandwidth Upgrades from 200 MHz to 350 MHz	MSO5000-BW2T3
<b>Memory Depth Option</b>	
Maximum memory depth up to 200 Mpts	MSO5000-2RL
<b>Channel Number Upgrade Option</b>	
Upgrade the Number of Analog Channels to 4 (only available for the MSO5XX2 model)	MSO5000-4CH
<b>Bundle Option</b>	
Function and Application Bundle Option, including MSO5000-COMP, MSO5000-EMBD, MSO5000-AUTO, MSO5000-FLEX, MSO5000-AUDIO,	MSO5000-BND

MSO5000-AERO, MSO5000-AWG, and MSO5000-PWR	
<b>Serial Protocol Analysis Option</b>	
PC Serial Bus Trigger and Analysis (RS232/UART)	MSO5000-COMP
Embedded Serial Bus Trigger and Analysis (I2C and SPI)	MSO5000-EMBD
Auto Serial Bus Trigger and Analysis (CAN and LIN)	MSO5000-AUTO
FlexRay Serial Bus Trigger and Analysis (FlexRay)	MSO5000-FLEX
Audio Serial Bus Trigger and Analysis (I2S)	MSO5000-AUDIO
MIL-STD-1553 Serial Bus Trigger and Analysis (MIL-STD-1553)	MSO5000-AERO
<b>Measurement Application Option</b>	
Dual-channel 25 MHz Arbitrary Waveform Generator	MSO5000-AWG
Built-in Power Analysis	MSO5000-PWR

**Note:** For all the mainframes, accessories, and options, please contact the local office of **RIGOL**.

## **Appendix B: Warranty**

**RIGOL** (SUZHOU) TECHNOLOGIES INC. (hereinafter referred to as **RIGOL**) warrants that the product will be free from defects in materials and workmanship within the warranty period. If a product proves defective within the warranty period, **RIGOL** guarantees free replacement or repair for the defective product.

To get repair service, please contact with your nearest **RIGOL** sales or service office.

There is no other warranty, expressed or implied, except such as is expressly set forth herein or other applicable warranty card. There is no implied warranty of merchantability or fitness for a particular purpose. Under no circumstances shall **RIGOL** be liable for any consequential, indirect, ensuing, or special damages for any breach of warranty in any case.



# Index

- +Duty..... 6-29
- +Rate..... 6-33
- +Width..... 6-28
- Acquisition Mode ..... 4-5
- AM ..... 17-14
- Anti-Aliasing ..... 4-10
- Area ..... 6-33
- AutoIP ..... 19-3
- Aux Output ..... 19-8
- Average ..... 4-5
- Bandwidth Limit..... 2-5
- Blackman-Harris ..... 6-9
- Built-in Waveform ..... 17-6
- Channel Coupling..... 2-5
- Channel Label..... 2-9, 2-10
- DC ..... 17-5
- DC offset voltage ..... 17-2
- Default Gateway ..... 19-4
- Delay..... 6-30
- Delay Calibration..... 2-8
- Delay Trigger..... 5-26
- Delayed Sweep..... 3-2, 3-4
- Digital Channel ..... 10-1
- Domain Name Server ..... 19-4
- Dots ..... 16-2
- Duration Trigger ..... 5-18
- Duty..... 17-4
- Duty..... 6-29
- ECC..... 17-7
- Edge Trigger..... 5-8
- Edge Type..... 5-30
- Edit Waveforms ..... 17-12
- End of Frame Error ..... 11-13
- Exp.Fall..... 17-7
- Factory Settings..... 18-13
- Fall Time..... 6-28
- Falling Edge Count..... 6-30
- Flattop..... 6-9
- FM ..... 17-15, 17-16
- Frequency..... 6-28, 17-2
- Gauss ..... 17-8
- GPIB..... 19-6
- Hamming ..... 6-9
- Hanning ..... 6-9
- Haversine ..... 17-9
- Horizontal Expansion ..... 4-10
- Horizontal Position..... 3-3
- I2C Decoding ..... 11-14
- I2C Trigger ..... 5-34
- I2S Trigger ..... 5-45
- Idle Time..... 5-31
- Impedance ..... 17-3
- IP Address..... 19-3
- Lorentz..... 17-8
- MAC..... 19-5
- mDNS ..... 19-5
- Memory Depth ..... 4-9
- Modulating Waveform .... 17-14, 17-15
- Modulation ..... 17-13
- Modulation Depth..... 17-14
- Modulation Deviation ..... 17-15
- Modulation Frequency... 17-14, 17-15, 17-16
- Negative Pulse Count..... 6-29
- Network Status ..... 19-2
- Noise ..... 17-5
- Noise Rejection ..... 5-7
- Normal ..... 4-5
- Nth Edge Trigger ..... 5-30
- Overshoot..... 6-33
- Parallel Decoding..... 11-2
- Pattern Setting ..... 5-16, 5-19
- Peak Detection..... 4-6
- Period ..... 6-28
- Period Area..... 6-33
- Persistence Time ..... 16-2
- Phase..... 6-30
- Picture ..... 18-2
- Polarity..... 5-10, 5-50
- Positive Pulse Count ..... 6-29
- Preshoot..... 6-33
- Probe Ratio..... 2-6, 2-7
- Pulse..... 17-4
- Pulse Condition ..... 5-10
- Pulse Polarity ..... 5-22
- Pulse Trigger..... 5-9

Pulse Width Setting.....	5-10	Trigger LEVEL/Threshold Level .....	5-3
Qualifier .....	5-22	Trigger Mode .....	5-4
Ramp .....	17-4	Trigger Position .....	5-24
-Rate.....	6-33	tVmax.....	6-29
Rectangular .....	6-9	tVmin.....	6-29
Rise Time .....	6-28	Vamp .....	6-32, 17-2
Rising Edge Count .....	6-29	Vavg .....	6-32
Roll .....	4-4	Vbase .....	6-32
RS232 Decoding.....	11-7	Vector.....	16-2
RS232 Trigger .....	5-31	Vertical Offset.....	2-4
Runt Trigger.....	5-22	Vertical Scale .....	2-3
Sample Point5-40, 5-44, 11-29, 11-34		Video Polarity .....	5-14
Sample Rate .....	4-7	Video Standard .....	5-14
Setup&Hold Trigger.....	5-28	Video Trigger .....	5-14
Setups.....	18-3	VISA .....	19-5
Sine .....	17-2	Vlower .....	6-32
Slope Condition .....	5-12	Vmax.....	6-32
Slope Time Setting .....	5-12	Vmid.....	6-32
Slope Trigger.....	5-11	Vmin.....	6-32
SPI Decoding .....	11-18	Vpp .....	6-32
SPI Trigger.....	5-36	Vrms.....	6-33
Square .....	17-3	Vtop .....	6-32
Start Keep .....	17-17	Vupper.....	6-32
Start Phase.....	17-3	Waveform Aliasing.....	4-8
Static IP .....	19-3	Waveform Distortion.....	4-7
Subnet mask.....	19-4	Waveform Leakage.....	4-8
Sweep.....	17-16, 17-18	Waves.....	18-3
Sweep Trigger Source ...	17-18, 17-19	-Width .....	6-29
Symmetry .....	17-4	Window trigger .....	5-24
Sync.....	5-15	Windows Type .....	5-24
To Create the Waveform.....	17-10	XY .....	4-2
Triangle .....	6-9	YT .....	4-2
Trigger Coupling .....	5-5		
Trigger Holdoff .....	5-6		