

optris® CT 1M/2M

Precise non-contact temperature measurement
from 250°C to 2200°C



FEATURES

- Miniaturized Infrared Thermometer with 1.0 μm respectively 1.6 μm wave length range for measurements of metals, of secondary metal processing, metal oxides and ceramic materials
- Very small sensing head of 14 mm diameter and 28 mm length fits everywhere and is usable up to 125°C ambient temperature without cooling
- Temperature ranges from 250°C to 2200°C, measuring spots up from 1.8 mm and exposure times up from 1 ms
- Short measuring wave length of 1.0 μm respectively 1.6 μm reduces error of temperature readings on surfaces with low or unknown emissivity

General Specifications

Environmental rating	IP 65 (NEMA-4)
Ambient temperature	-20°C to 100°C (1M) to 125°C (2M) (sensing head) 0°C to 85°C (electronics)
Storage temperature	Sensing head: -40°C to 100°C (1M) to 125°C (2M) Electronics: -40°C to 85°C
Relative humidity	10 - 95%, non condensing
Vibration (sensor)	IEC 68-2-6: 3 G, 11-200 Hz, any axis
Shock (sensor)	IEC 68-2-27: 50 G, 11 ms, any axis
Weight	Sensing head: 40 g Electronics: 420 g

Electrical Specifications

Outputs/analog	0/4 - 20 mA, 0-5/10 V, thermocouple J, K, alarm
Alarm output	24 V/50 mA (open collector)
Optional	relay: 2 x 60 V DC/42 V AC _{eff} ; 0.4 A; optically isolated
Outputs/digital (optional)	USB, RS232, RS485, CAN, Profibus DP, Ethernet
Output impedances	mA max. 500 Ω (with 8-36 V DC) mV min. 100 k Ω load impedance thermocouple 20 Ω
Inputs	programmable functional inputs for external emissivity adjustment, ambient temperature compensation, trigger (reset of hold functions)
Cable length	3 m (standard), 8 m, 15 m
Current draw	max. 100 mA
Power Supply	8-36 V DC

Measurement Specifications

Temperature ranges (scalable via programming keys or software)	485°C to 1050°C (1ML) 650°C to 1800°C (1MH) 800°C to 2200°C (1MH1) 250°C to 800°C (2ML) 385°C to 1600°C (2MH) 490°C to 2000°C (2MH1)
Spectral ranges	1.0 μm (1M)/1.6 μm (2M)
Optical resolution CT 1ML/2ML (90% energy)	40:1 (2.7 mm @ 110 mm)
Optical resolution CT 1MH/1MH1/2MH/2MH1 (90% energy)	75:1 (1.5 mm @ 110 mm)
System accuracy ¹⁾ (at ambient temp. 23 \pm 5°C)	\pm (0.3% of reading + 2°C)
Repeatability (at ambient temp. 23 \pm 5°C)	\pm (0.1% of reading + 1°C)
Temperature resolution	0.1 K
Exposure time ²⁾	1 ms (90 %)
Emissivity/Gain (adjustable via programming keys or software)	0.100 - 1.100
Transmissivity/Gain (adjustable via programming keys or software)	0.100 - 1.100
Signal processing (parameter adjustable via programming keys or software, respectively)	peak hold, valley hold, average; extended hold function with threshold and hysteresis
Software	optris Compact Connect

¹⁾ $\epsilon = 1$, Exposure time 1 s

²⁾ with dynamic adaptation at low signal levels

Optical Specifications

CT 1ML/2ML SF, D:S = 40:1

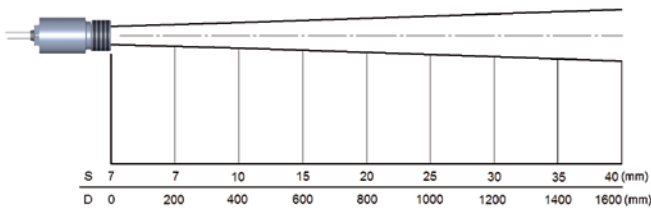

CT 1ML/2ML CF, D:S = 40:1 (far field = 12:1)

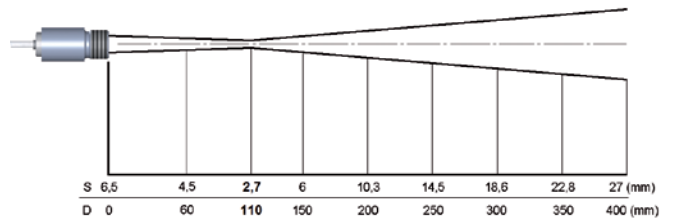

CT 1MH/1MH1/2MH/2MH1 SF, D:S = 75:1

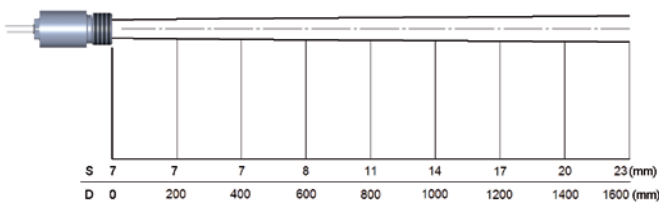

CT 1MH/1MH1/2MH/2MH1 CF, D:S = 75:1
(far field = 14:1)

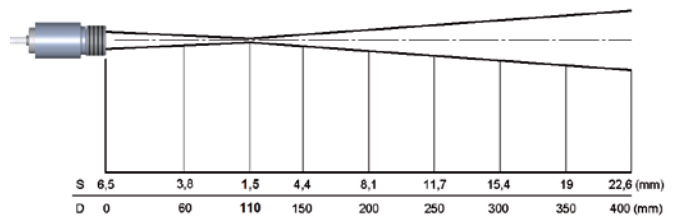

Dimensions

Sensing head

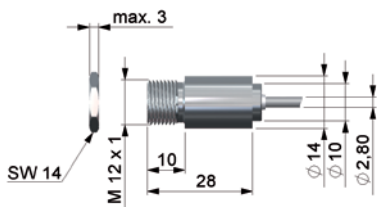

Electronics

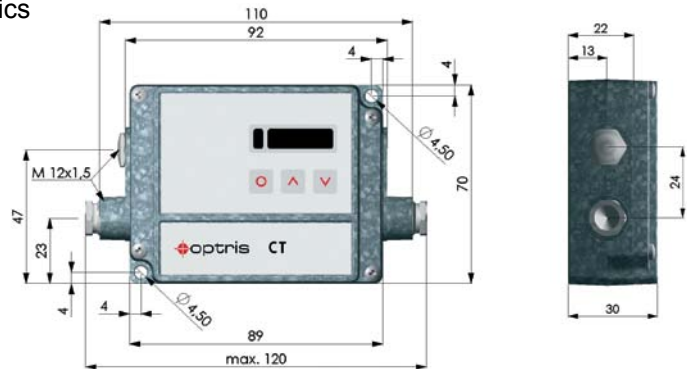

Accessories (examples)

CF-lens
(ACCTCFHT)

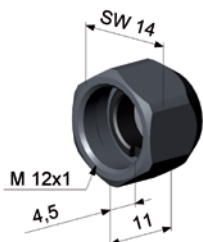

Air purge collar with
integrated CF-lens
(ACCTAPLCFHT)

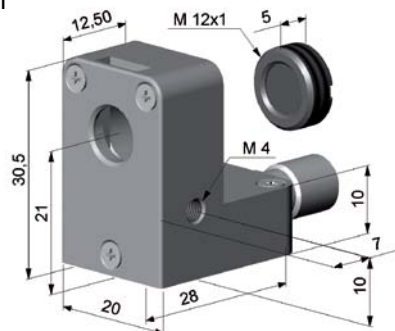

Mounting
bracket, fixed
(ACCTFB)

