

Inductive distance measuring sensors

IWFM 20I9503/S35

dimension drawing

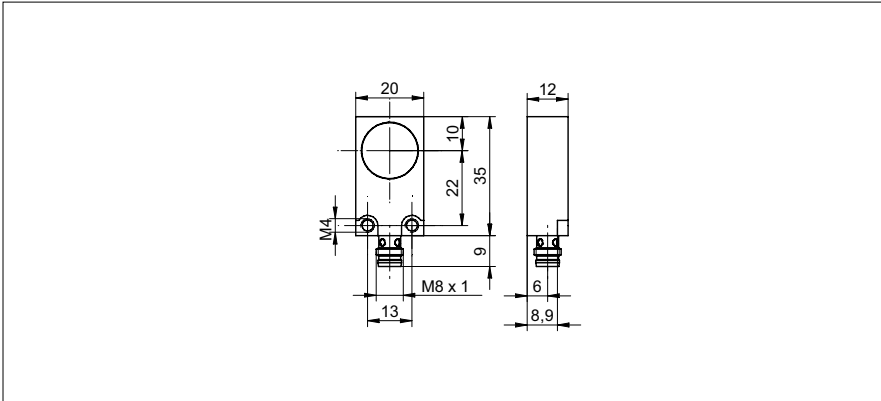

general data

mounting type	flush
measuring distance Sd	2 ... 3 mm
reference distance	2,35 ... 2,65 mm
measuring speed	< 1 mm / ms
repeat accuracy	< 0,01 mm
linearity error	± 60 µm
temperature coefficient	1 µm / (K mm)

electrical data

voltage supply range +Vs	15 ... 30 VDC
current consumption max. (no load)	35 mA
output circuit	current output
output signal	4 ... 20 mA
load resistance +Vs min.	< 500 Ohm
load resistance +Vs max.	< 1000 Ohm
residual output ripple	< 0,5 % Vs
short circuit protection	yes
reverse polarity protection	yes

mechanical data

type	rectangular
housing material	brass nickel plated
dimension	20 mm
housing length	35 mm
connection types	connector M8

ambient conditions

operating temperature	0 ... +60 °C
protection class	IP 67

photo



connection diagram

