

Inductive distance measuring sensors

IWRM 18U9512

dimension drawing

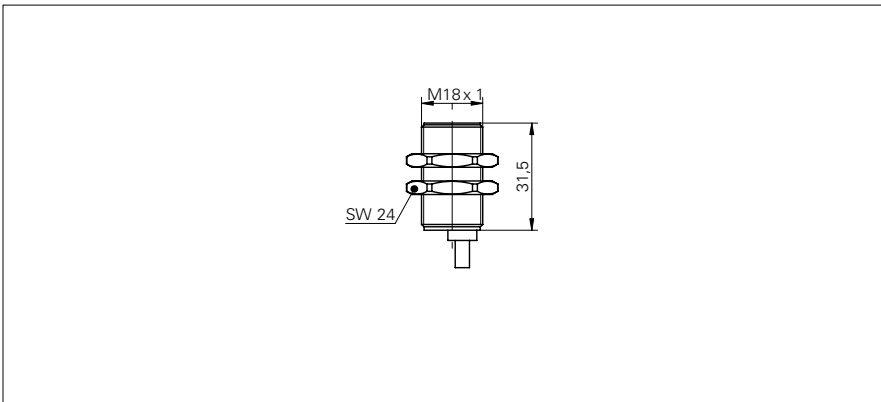

general data

mounting type	flush
measuring distance Sd	2 ... 4 mm
reference distance	2,8 ... 3,2 mm
measuring speed	< 1 mm / ms
repeat accuracy	< 0,02 mm
linearity error	± 80 µm
temperature coefficient	1 µm / (K mm)

electrical data

voltage supply range +Vs	15 ... 30 VDC
current consumption max. (no load)	20 mA
output circuit	voltage output
output signal	1 ... 9 VDC
load resistance	> 1000 Ohm
residual output ripple	< 0,5 % Vs
short circuit protection	yes
reverse polarity protection	yes

mechanical data

type	cylindrical threaded
housing material	brass nickel plated
dimension	18 mm
housing length	31,5 mm
connection types	cable, 2 m

ambient conditions

operating temperature	0 ... +60 °C
protection class	IP 67

photo



connection diagram

