

High precision analog sensors

IPRM 12I9506/S14

dimension drawing

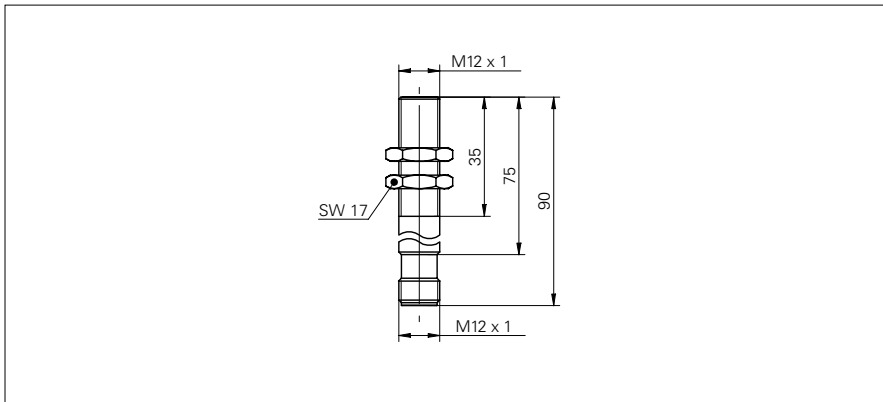

general data

mounting type	quasi-flush
measuring speed	< 1 mm / ms
measuring distance Sd	0 ... 3 mm
resolution (RMS)	< 0,08 µm (stat. 10 Hz) < 0,17 µm (dynam. 520 Hz) < 0,013 µm (range center)
linearity error	± 150 µm
repeat accuracy (Sd)	< 1 µm
temperature drift	± 25 µm

electrical data

voltage supply range +Vs	15 ... 30 VDC
current consumption max. (no load)	50 mA
output circuit	current output
output signal	0 ... 20 mA
load resistance +Vs min.	< 100 Ohm
load resistance +Vs max.	< 400 Ohm
voltage drop Vd	< 7 VDC
short circuit protection	yes
reverse polarity protection	yes

mechanical data

type	cylindrical threaded
dimension	12 mm
housing length	90 mm
housing material	steel (9 SMn (Pb) 28/36)
material (sensing face)	ceramic
connection types	connector M12

ambient conditions

operating temperature	0 ... +60 °C
protection class	IP 67

photo



connection diagram

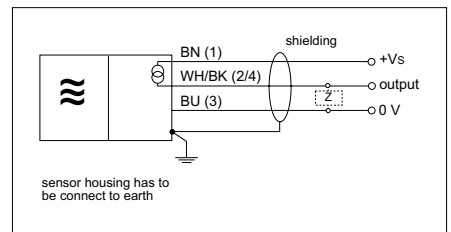

installation drawing

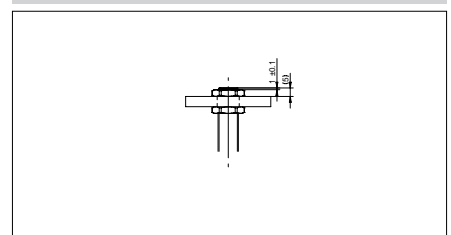

• peak to peak = 6 x RMS