

Inductive distance measuring sensors

IWFM 12L9504/S35A

dimension drawing

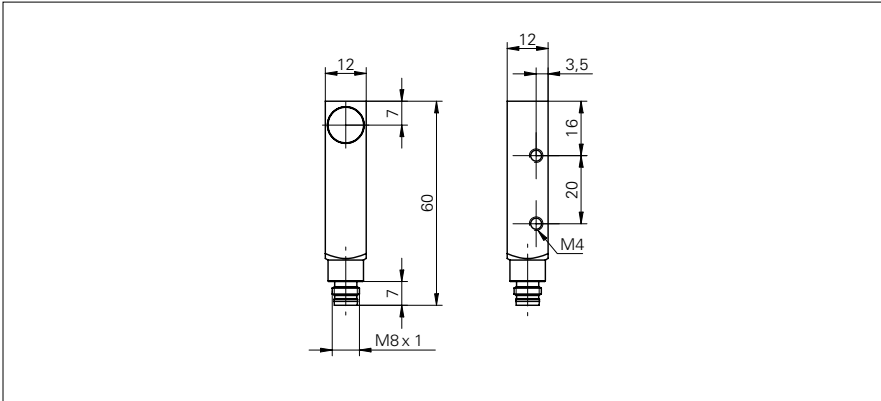

general data

mounting type	flush
measuring distance Sd	0 ... 4 mm
resolution	< 0,005 mm
repeat accuracy	< 0,01 mm
linearity error	± 160 µm
temperature drift	± 4 % (Full Scale)

electrical data

response time (factory characteristic)	< 2 ms
voltage supply range +Vs	15 ... 30 VDC
current consumption max. (no load)	40 mA
output circuit	voltage - / current output
output signal	0 ... 10 V / 4 ... 20 mA
load resistance	> 1000 Ohm (Uout) / 330 ... 1000 Ohm (Iout)
voltage drop Vd	< 7,2 VDC (Iout)
short circuit protection	yes
reverse polarity protection	yes

mechanical data

type	rectangular
housing material	brass nickel plated
dimension	12 mm
housing length	60 mm
connection types	connector M8

ambient conditions

operating temperature	-10 ... +70 °C
protection class	IP 67

photo



connection diagram

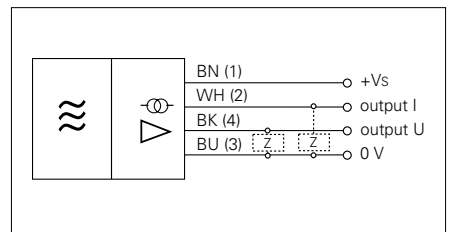

- linearity deviation (S = 0,5...4 mm) ± 4% (Full Scale)
- load resistance: Uout min 1000 Ohm / Iout 330 - 1k
- voltage drop Vd: Iout 7,2 V