

# FADK 14U4470/IO

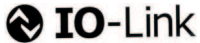

Distanz Sensor

Distance Sensor

Détecteur de distance



11014497



Baumer Electric AG · CH-8501 Frauenfeld  
Phone +41 (0)52 728 1122 · Fax +41 (0)52 728 1144



## Abmessungen Dimensions Dimensions

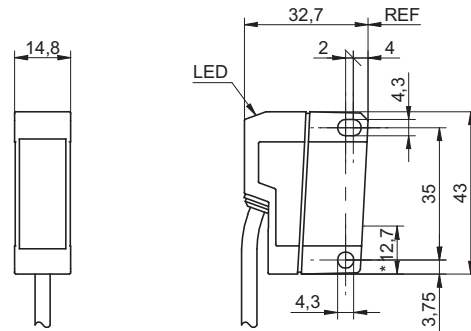

- Alle Maße in mm
- All dimensions in mm
- Toutes les dimensions en mm
- \* Senderachse
- \* Emitter axis
- \* Axe de l'émetteur

## Elektrischer Anschluss Connection diagram Schéma de raccordement

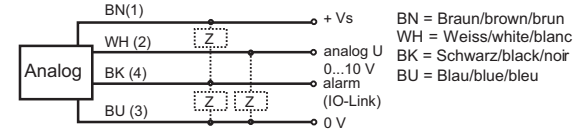

BN = Braun/brown/brun  
WH = Weiss/white/blanc  
BK = Schwarz/black/noir  
BU = Blau/blue/bleu

## Ausgang Charakteristik Output characteristic Caractéristique de sortie

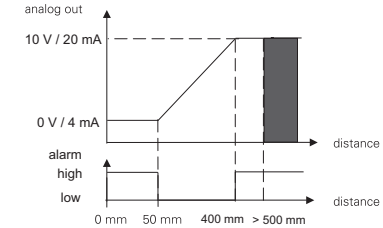

- Vor dem Anschliessen des Sensors die Anlage spannungsfrei schalten.
- Disconnect power before connecting the sensor.
- Mettre l'installation hors tension avant le raccordement du détecteur.

**Canada**  
Baumer Inc.  
CA-Burlington, ON L7M 4B9  
Phone +1 (1)905 335-8444

**China**  
Baumer (China) Co., Ltd.  
CN-201612 Shanghai  
Phone +86 (0)21 6768 7095

**Denmark**  
Baumer A/S  
DK-8210 Aarhus V  
Phone: +45 (0)8931 7611

**France**  
Baumer SAS  
FR-74250 Fillinges  
Phone +33 (0)450 392 466

**Germany**  
Baumer GmbH  
DE-61169 Friedberg  
Phone +49 (0)6031 60 07 0

**India**  
Baumer India Private Limited  
IN-411058 Pune  
Phone +91 20 66292400

**Italy**  
Baumer Italia S.r.l.  
IT-20090 Assago, MI  
Phone +39 (0)2 45 70 60 65

**Singapore**  
Baumer (Singapore) Pte. Ltd.  
SG-339412 Singapore  
Phone +65 6396 4131

**Sweden**  
Baumer A/S  
SE-56133 Huskvarna  
Phone +46 (0)36 13 94 30

**Switzerland**  
Baumer Electric AG  
CH-8501 Frauenfeld  
Phone +41 (0)52 728 1313

**United Kingdom**  
Baumer Ltd.  
GB-Watchfield, Swindon, SN6 8TZ  
Phone +44 (0)1793 783 839

**USA**  
Baumer Ltd.  
US-Southington, CT 06489  
Phone +1 (1)860 621-2121

### Technische Daten

### Technical data

### Données techniques

Messbereich	Measuring range	Plage de mesure	50...400 mm
Auflösung (matt weisse Keramik)	Resolution (matt white ceramic)	Résolution (céramique blanche mate)	0,1...1 mm
Linearitätsabweichung (matt weisse Keramik)	Linearity error (matt white ceramic)	Déviation de linéarité (céramique blanche)	± 1,5... ± 4 mm
Lichtquelle	Light source	Source de lumière	pulsed point source LED
Ansprechzeit	Response time	Temps d'activation	< 3 ms
Analogausgang	Analog output	Sortie analogique	0...10 V
Alarmausgang	Alarm output	Sortie d'alarme	push-pull
Betriebsanzeige	Power indicator	Affichage de fonctionnement	green LED
Anzeige Alarm- / Verschm.	Soiled lens indicator	Indication alarme / encrassement	red LED
Betriebsspannungsbereich Vs (UL-Class 2)	Voltage supply range Vs (UL-Class 2)	Plage de tension Vs (UL-Class 2)	14...26 VDC
max. Stromverbrauch	max. supply current	Consommation max.	< 80 mA
Kurzschlussfest	Short circuit protection	Protégé contre courts-circuits	ja / yes / oui
Verpolungsfest	Reverse polarity protection	Protégé contre inversion de polarité	ja / yes / oui *
Arbeitstemperaturbereich	Operating temperature range	Température en service	0...50 °C
Schutzklasse	Protection class	Classe de protection	IP 67
Temperaturdrift	Temperature drift	Dérive en température	< 0,1 % Sde/K

Siehe Betriebsanleitung auf [www.baumer.com](http://www.baumer.com) See manual on [www.baumer.com](http://www.baumer.com)

Voir le manuel sur [www.baumer.com](http://www.baumer.com)



\* nur Betriebsspannung / voltage supply only / plage de tension

Technische Änderungen vorbehalten Technical specifications subject to change Sous réserve de modifications techniques

Montage  
Mounting  
Montage

Stufen  
Steps  
Gradins

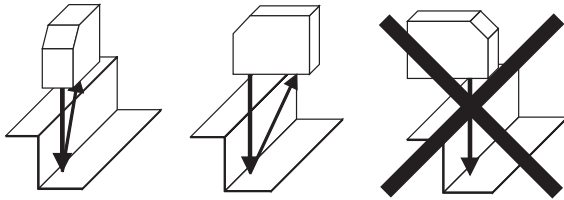

Alarm ON

Runde, glänzende Oberflächen  
Round glossy surfaces  
Surfaces ronds brillantes

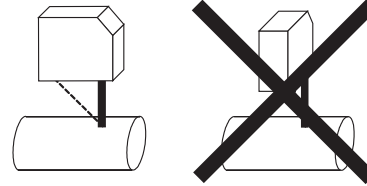

Glänzende Oberflächen  
Glossy surfaces  
Surfaces brillantes

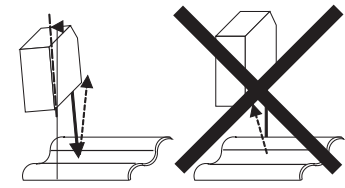

Unterschiedlich reflektierende Oberflächen  
Different reflection of surfaces  
Surfaces différemment réfléchissantes



Einwirkung Fremdlicht  
Effect of ambient light  
Influence lumière ambiante

