



testo 6448 · Compressed air counter probe

Instruction manual



1 Contents

1	Contents	3
2	Safety and the environment.....	5
2.1.	About this document.....	5
2.2.	Safety.....	5
2.3.	Protecting the environment.....	7
3	Specifications	8
3.1.	Use	8
3.2.	Overview.....	9
3.3.	Technical data	10
3.3.1.	Dimensions for the compressed air bar probe (mm)	10
3.3.2.	Technical data for the compressed air bar probe	11
3.3.3.	Description & technical data - accessories/service.....	14
3.3.3.1.	Tapping clamp.....	14
3.3.3.2.	Ball valve.....	15
3.3.3.3.	Measurement fitting including ball valve	15
3.3.3.4.	Drill unit.....	16
3.3.3.5.	Connecting cable.....	16
3.3.3.6.	Parameterisation/calibration:	16
4	Initial operation.....	17
4.1.	Mechanical assembly	17
4.1.1.	Preparation	17
4.1.2.	Assembly of the clamp.....	20
4.1.3.	Assembly of the measurement fitting/ball valve	21
4.1.4.	Checking the clamp leak-tightness.....	22
4.1.5.	Drilling holes in a compressed air line.....	22
4.1.6.	Assembly of the PBCover reverse running protection unit.....	23
4.2.	Electrical connection.....	24
5	Operation.....	27
5.1.	Operation and display elements	27
5.1.1.	Types of operation	28
5.1.2.	Menu overview.....	30
5.1.3.	Programming	31
5.1.4.	Adjustable parameters.....	32
5.1.5.	Setting the preset counter / pulse value (ImPS).....	38
6	Cleaning the sensor	43
6.1.	Cleaning agents.....	43





6.2.	Calibration.....	43
7	Troubleshooting.....	44
7.1.	Replacing damaged parts	44
7.2.	Replacing O-rings and seal rings	44
7.3.	Error messages.....	44

2 Safety and the environment

2.1. About this document

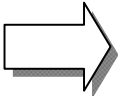
Symbols and writing standards

The following characters and symbols are used in this instruction manual to emphasise text passages that need special attention.

Symbol	Explanation
	Notes This arrow points out specifics that must be observed during operation.
	Caution! This symbol indicates text passages which, if not complied with or not followed specifically, may lead to the damage or destruction of system parts.
	Warning! This symbol is placed in front of text passages which may be hazardous to one's health or life if not complied with.
	The symbol points out further information in other manuals, chapters or sections.
Menu	Elements of the instrument, the instrument display or the program interface.
[OK]	Control keys of the instrument or buttons of the program interface.

2.2. Safety

The compressed air counter was built and checked reliably according to state-of-the-art technology and left the factory in an appropriately safe condition.

As the user, you are responsible for the compliance with all valid safety regulations, including:

- Installation specifications
- Local standards and regulations

The manufacturer has undertaken all necessary measures to ensure safe operation. The user must ensure that the instruments are set up and installed in such a way that their safe use is not affected.

The instruments are factory-tested and were delivered in a safe condition.

These operating instructions contain information and warnings that must be followed by the user in order to ensure safe operation.

- Assembly, commissioning, operation and maintenance of the measuring unit may only be performed by trained authorised personnel. The personnel must be authorised for the specified tasks by the system operator.
- The authorised personnel must have read and understood these operating instructions, and must comply with the directions contained herein.
- Check that all connections are correct before commissioning the complete measuring point.
- Do not commission damaged products and keep these from being inadvertently commissioned. Mark the damaged products as defective.
- Faults at the measuring point may only be corrected by authorised and specially trained personnel.
- If faults cannot be corrected, the products must be taken out of operation and secured from inadvertent commissioning.
- Repairs that are not described in these operating instructions may only be carried out directly by the manufacturer or by the service organisation.

Exclusion of liability

Liability of the manufacturer and its assistants exists only in the event of deliberate acts or gross negligence. The extent of liability is limited to the value of the respective order placed with the manufacturer.

The manufacturer accepts no liability for damages that occur due to non-observance of the safety instructions or non-compliance with the instruction manual or the operating conditions. Consequential damages are excluded from the liability.

Use

- Please read this documentation through carefully and familiarize yourself with the product before putting it to use. Pay particular attention to the safety instructions and warning advice in order to prevent injuries and damage to the products.
- Keep this document to hand so that you can refer to it when necessary.
- Hand this documentation on to any subsequent users of the product.

2.3. Protecting the environment

- At the end of its useful life, send the product to the separate collection for electric and electronic devices (observe local regulations) or return the product to Testo for disposal.

3 Specifications

3.1. Use

The compressed air counter is intended exclusively for use in pipe systems for working compressed air, provided that the calibration certificate does not explicitly allow use with other gases.

Its design means that it can be operated in pressurised systems up to PN16 and with a tapping clamp from DN250 up to PN10.

Use which deviates from that described endangers the safety of people and of all the measuring equipment and is thus not permissible.

The manufacturer accepts no liability for damages that occur as a result of improper or inappropriate use or installation.

To avoid damage to the instrument or health hazards, no manipulation using tools may occur on the measuring units unless expressly defined in this operating manual.

During operation, the sensors may only be changed by authorised personnel.

To ensure the safety of the user and the functionality of the instruments, the commissioning steps, checks and maintenance work recommended by the manufacturer are to be complied with and carried out.

These instructions do not contain complete detailed information for the sake of transparency.

Should you require further information or should a specific problem occur that is not comprehensively handled in the instructions, you can request the required information directly from the manufacturer.

3.2. Overview

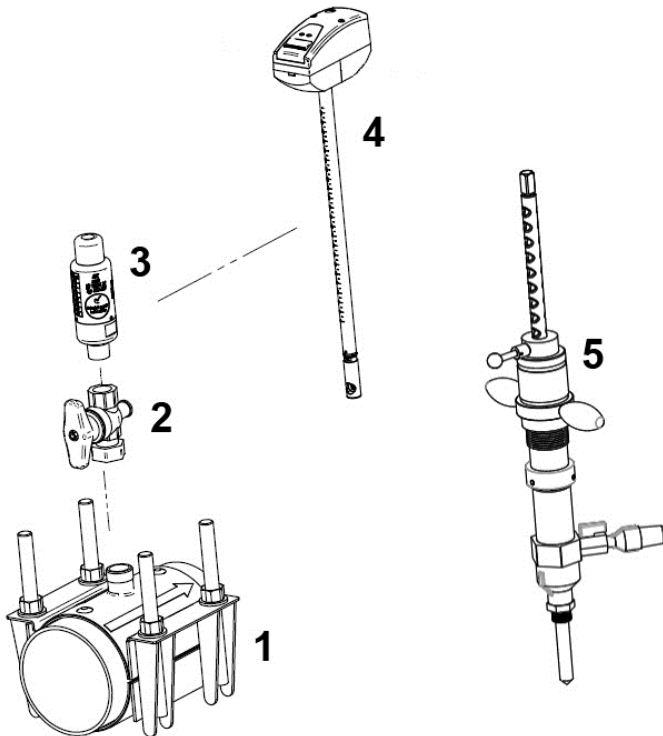

- 1 Tapping clamp (optional)
- 2 Measurement fitting with quick-release coupling (optional)
- 3 PBCover reverse running protection
- 4 Compressed air bar probe
- 5 Drilling tool (optional)

3.3. Technical data

3.3.1. Dimensions for the compressed air bar probe (mm)

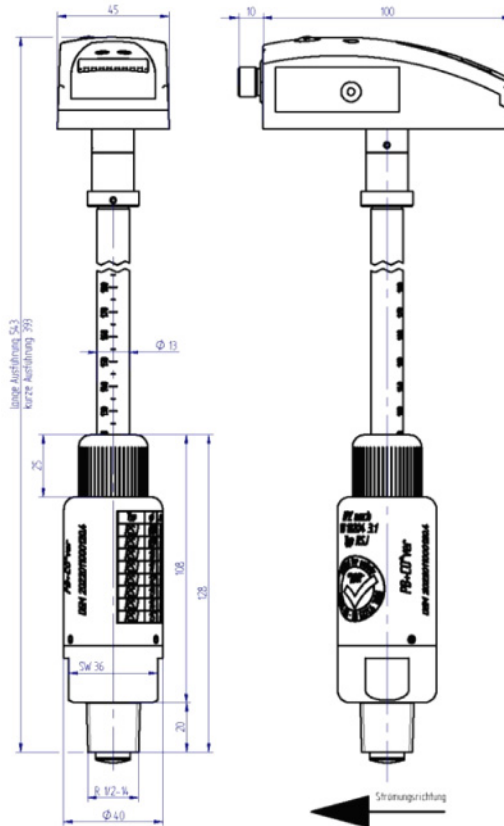

3.3.2. Technical data for the compressed air bar probe

The thermal mass flow sensor for the compressed air volume flow measurement is independent of the process pressure and the media temperature.

Sensor

Sensor material	Thermal, glass-coated ceramic sensor
Measurement method	Calorimetric
Accuracy	For compressed air quality classes (ISO 8573: particles to humidity to oil) 1-4-1: $\pm 3\%$ of meas. value, $\pm 3\%$ of final value For compressed air quality classes (ISO 8573: particles to humidity to oil) 3-4-4: $\pm 6\%$ of meas. value, $\pm 6\%$ of final value
Measuring dynamics	1:150 or 1:300
Response time	< 0.1 s (where damping parameter = 0), can be delayed via user menu (0 to 1 s)

Measurement parameters

Flow velocity	
Selectable units	m/s
Measuring range ¹	160 m/s
Volumetric flow	
Selectable units	m ³ /h, m ³ /min, m ³
Measuring range ¹	The measuring range of the volumetric flow depends on the inner pipe diameter
Temperature	
Selectable units	°C
Measuring range	0 to +60 °C / 32 °F ... +140 °F

¹ The measuring ranges refer to the standard volumetric flow as per DIN ISO 2533 (15 °C, 1013 mbar and 0% rel. humidity)

Inputs and outputs	
Analog outputs	
Output type	4 to 20 mA (4-wire), freely scalable between zero and the end of the measuring range for m ³ /min, m ³ /h, m/s and °C
Load	Max. 500 Ω
Further outputs	
Pulse output	Pulse valence adjustable in increments of 1 m ³ (recommended increments are 1 m ³ , 10 m ³ , 100 m ³ and 1,000 m ³ , or preset counter up to 1,000,000 m ³)
Switching output	2 switching outputs, programmable (dependent on consumption or volumetric flow, NC or NO contact, hysteresis, window), switch statuses are displayed via 2 LEDs
Capacitance	Can each carry a load of max. 18 to 30 V DC or 250 mA
Supply	
Voltage supply	18 to 30 V DC, power consumption < 100 mA
Current consumption	<100 mA
Connection	M12 x 1 plug, load capacity up to 250 mA, short-circuit-proof (synchronised), protected against polarity reversal, overload-proof
General technical data	
Housing design	
Housing material	PBT-GF 20, PC (APEC), Makrolon, V2A (1.4301), Viton
Weight	850 g
Media contact	V2A (1.4301), glass-coated ceramic, PEEK, polyester, Viton, anodised aluminium
Protection class	IP65 / III
Display	
Display	4-digit alphanumeric display, two operating buttons, operation menu, LEDs (6x green for physical units, 2x yellow for switch statuses)
Display units	m ³ /min, m ³ /h, m/s, m ³ , °C

Operation	
Parameterisation	2 operating buttons
Standard reference	Volumetric flow conversion with manual input option for temperature, humidity and pressure. Factory setting: 15 °C, 1013.25 hPa, 0%RH.
Miscellaneous	
Protection class	IP65
EMC	EN 6126-1:2006 class B/EN 6126-1:2006 table 2
IEC 1000/4/2 ESD	4/8 kV
IEC 1000/4/3 HF radiated	10 V/m
IEC 1000/4/4 burst	2 kV
IEC 1000/4/6 HF grid-bound	10 V
Warranty	2 years, for warranty terms, see www.testo.com/warranty Compressed air (CO ₂ , N ₂ also possible with special calibration)

Operating conditions

Humidity (sensors)	Rel. humidity (90 %RH)
Ambient temperature	0 to +60 °C
Medium temperature	0 to +60 °C (rel. humidity max. 90%)
Storage temperature	-25 to +85 °C
Pressure-tight	Up to 16 bar overpressure

**Measuring range for volumetric flow as per DIN2533
depending on pipe diameter**

Version	Inner pipe diameter in mm	Measuring range (160 m/s)
DN 40	40.9	0 to 600 m ³ /h
DN 50	53.1	0 to 1000 m ³ /h
DN 65	70.3	0 to 1880 m ³ /h
DN 80	82.5	0 to 2600 m ³ /h
DN 100	107.00	0 to 4400 m ³ /h
DN 125	131.7	0 to 6700 m ³ /h
DN 150	159.3	0 to 9950 m ³ /h
DN 200	207.3	0 to 17000 m ³ /h
DN 250	260.4	0 to 25600 m ³ /h

3.3.3. Description & technical data - accessories/service

3.3.3.1. Tapping clamp

The tapping clamp allows the sensor to be installed precisely without the need for welding. Using the drill unit enables installation under pressure. The sensor can be installed & dismantled under pressure when the tapping clamp and the measurement fitting described below are used.

Technical data for the tapping clamp

Tapping clamp material	Stainless steel 304/A2, Perbunan (NBR) 70 Shore insert, stainless steel A2 nuts and stainless steel screws.
Pressure resistance	PN16 for DN40 to DN200, PN10 for DN250

Tapping clamp material	Stainless steel 304/A2, Perbunan (NBR) 70 Shore insert, stainless steel A2 nuts and stainless steel screws.
Nominal widths/ tolerance ranges	Nominal width: Tolerance range: DN 40/50 47 – 67 mm DN 65 73 – 80 mm DN 80 86 – 106 mm DN 100 107 – 127 mm DN 125 128 – 148 mm DN 150 149 – 171 mm DN 200 216 – 238 mm DN 250 260 – 280 mm

3.3.3.2. Ball valve

The integrated ball valve enables the compressed air line to be isolated from the measuring instrument.

Measurement fitting material	Brass, nickel-plated
Connections	DN15 internal thread for sensor DN20 union nut for tapping clamp/welding socket

3.3.3.3. Measurement fitting including ball valve

The measurement fitting has a pipe clamp connection and a DN8 connection for a quick-release coupling. The integrated ball valve enables the compressed air line to be isolated from the measuring instrument.

The quick-release coupling is used to integrated an additional measuring point (e.g. the Testo dewpoint transmitter)

Technical data for the measurement fitting

Measurement fitting material	Brass, nickel-plated
Connections	DN15 internal thread DN8 connection for quick-release coupling 7.2 mm

3.3.3.4. Drill unit

The special drill unit, when used in conjunction with a ball valve and tapping clamp, enables the compressed air bar probe to be installed under pressure. An additional instruction manual is available for this and is provided with the drill.

3.3.3.5. Connecting cable

The connecting cable (article no. 0699 3393) is used for the power supply and to transfer measurement data

Technical data for the connecting cable:

Length	5 m
Connection	4-pin, galvanically isolated, M12x1 socket/open cable end

3.3.3.6. Parameterisation/calibration:

- Sensor parameterisation for CO₂ and N₂: Six measuring points are parameterised with specified nominal widths, standard temperatures and pressures for nitrogen or carbon dioxide, then moved to the test stand where the standard volume is tested.
- ISO calibration points: For the purpose of basic characteristics and accuracy, six measuring points are parameterised with specified nominal widths, standard temperatures and pressures, then moved to the test stand where the standard volume is tested.
- ISO certificate: An ISO certificate from the manufacturer indicates six measuring points with m³/min (incl. standard conditions). The six ISO calibration points are required for this.

4 Initial operation

4.1. Mechanical assembly

4.1.1. Preparation

Determining the installation point

The installation point should be easily accessible and experience only low vibrations. The ambient temperature must not exceed the values specified in the technical data (pay attention to possible heat radiation).

Please note that a clearance of at least 400 mm is required for deinstallation of the sensor. When planning the measuring point, this is in addition to the space required for the measurement fitting or tap of at least 95 mm, or the space for the existing fittings (also including possible reductions to DN 15).

During assembly, consider the flow direction and required inflow/outflow routes.

Also consider the installation point with regard to the specified technical data. The medium may not be in a condensed state at the installation point. For this reason, the location in a working compressed air network can only be behind a suitable compressed air dryer which provides a suitable pressure dew point; otherwise the specified measurement accuracy is not guaranteed.

Do not install the sensor in the crossed-out installation positions shown in the following graphic. In the event of a limited flow, the specified accuracy cannot be maintained.

Schematic diagram (the arrow shows the direction of flow for the medium):

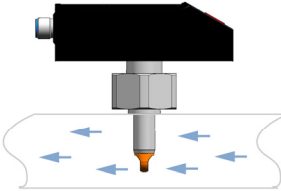
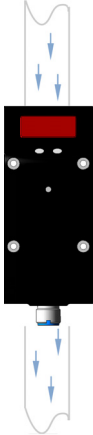
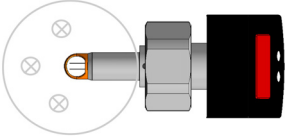
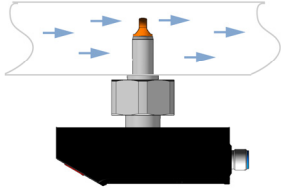
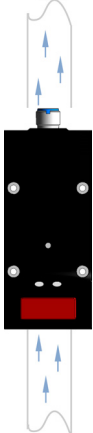
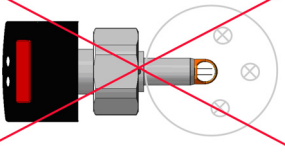
		
<p>Vertical installation position, direction of flow horizontally to the left, sensor downwards</p>	<p>Horizontal installation position, direction of flow vertically downwards, sensor to the rear</p>	<p>Horizontal installation position, direction of flow horizontally to the rear, sensor to the left (heated sensor element upwards)</p>
		
<p>Vertical installation position, direction of flow horizontally to the right, sensor upwards</p>	<p>Horizontal installation position, direction of flow vertically upwards, sensor to the rear</p>	<p>Horizontal installation position, direction of flow horizontally to the rear, sensor to the right (heated sensor element downwards, problems possible at low flow rates)</p>

Direction of flow

The direction of flow must be taken into account when installing the measurement fitting. This is shown on the tapping clamp by means of an arrow (Compac-Air system). The arrow points in the direction in which the medium in the pipeline flows.

If only the electronic sensor with PBCOver reverse running protection is used, then make sure the sensor display points against the direction of flow.



The sensor must be parallel to the direction of flow. Angular displacement leads to severe measurement errors.

Required measurement route

Bear in mind the required inflow and outflow routes in order to achieve the specified measurement accuracy. The inflow route refers to the pipeline length in front of the mass flow sensor and the outflow route to the pipeline length behind the mass flow sensor, as seen in the direction of flow for the medium.



The length of inflow route E depends on the design of the pipeline upstream of the sensor, vertical (see table below). The outflow route depends on the pipe diameter. Inflow and outflow routes are calculated as follows:

Total measurement route = inflow route + outflow route

Outflow route = $5 \times D$

Inflow route = E (see table below)

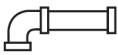
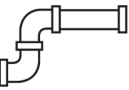
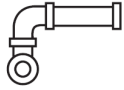
D = pipe diameter [mm]

	Changes to the pipe diameter	$E = 20 \times D$
	90° manifold	$E = 20 \times D$
	Two 90° manifolds, one level	$E = 25 \times D$
	Two 90° manifolds, two levels	$E = 30 \times D$
	Valve, slider	$E = 50 \times D$

On-site preparations

The installation point must be freely accessible and there must be enough space to work around the pipes.

A stable stepladder is required for all assembly work carried out up to 3.5 metres off the floor (height of the pipe). A working platform must be provided for work at greater heights. If the measuring point cannot be accessed by a platform, then scaffolding or other equipment must be used to provide a safe working platform.

Any cladding or insulation covering the pipes must be removed around the measuring point (clearance of at least 0.6 metres).

Necessary grinding work in the case of corroded pipes must be carried out before montage.

4.1.2. Assembly of the clamp

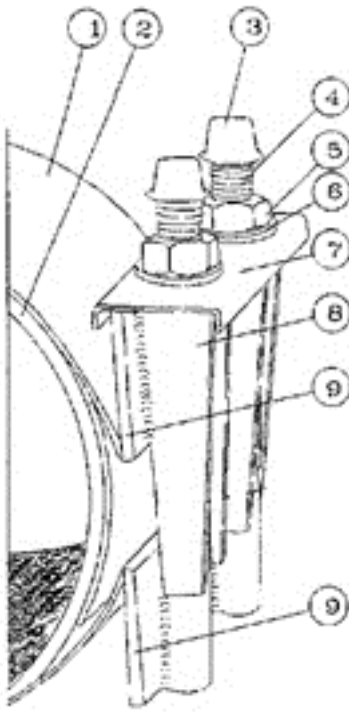

- 1 Clamp
- 2 Seal
- 3 Cap
- 4 Threaded bolt
- 5 Nut
- 6 Delrin® washer
- 7 Retaining bracket
- 8 Screw yoke
- 9 Side bracket

Observe before and during assembly

1. Compare the pipe diameters and check the correct size of the clamp.
 2. Before the clamp is assembled, always check the installation position of the sensor and the position of the clamp.
-  Preparation, page 17.
3. Prepare the compressed air line: eliminate all traces of dirt, rust and grease from the assembly point of the clamp so that the surface of the pipe is smooth and clean. The seals and slide plate should be wetted to achieve better adhesion. Seals, nuts and bolts must not be greased!
 4. Before assembly, mark the position of the clamp to ensure a correct fit.
 5. During assembly, ensure that the seals and holder lips remain clean and that no foreign bodies are found between the seal and pipe.
 6. Position the tapping clamp and screw the nuts on manually.
 7. Tighten the nuts to the specified torque.

The following torques must be observed:

M14: 85 Nm

M16: 110 Nm



Always carry out a pressure test before pressurising the clamp.



Checking the clamp leak-tightness, page 22.

4.1.3. Assembly of the measurement fitting/ball valve

Tools:

- Teflon tape
- Seal ring
- 2x open end spanners 27 mm, 30 mm

1. Wrap Teflon tape around the tapping clamp screw socket.
2. Together with a seal ring, mount the measurement fitting and screw on by hand.
3. Tighten screw with an open end spanner. Counterhold the measurement fitting using another open end spanner.

4.1.4. Checking the clamp leak-tightness

Tools:

- Hearing protection
 - Pressurised cylinder with valve or compressed air pipe
1. Screw the compressed air bar probe on to the measurement fitting and tighten.
 2. Connect the pressurised cylinder or compressed air pipe to the quick-release coupling.
 4. Using a manometer, leak spray and hearing protection, carry out a leak-tightness test.
 5. In the event of leaks, adjust the torque and carry out the leak-tightness test again after 20 minutes.
 6. Once the test has been passed, remove the compressed air pipe or pressurised cylinder. Ensure that the valve of the pressurised cylinder is closed or the compressed air line is disconnected from the compressed air supply. Then open the measurement fitting ball valve. Wear hearing protection for this.



First close the pressurised cylinder valve or disconnect the compressed air line from the main supply. Then open the measurement fitting.

4.1.5. Drilling holes in a compressed air line



Assembly under pressure may only be carried out by trained personnel. Before drilling holes in a compressed air line, always observe the separate instruction manual for the drill!

4.1.6. Assembly of the PBCOver reverse running protection unit



- 1 Work surface for 36 mm wrench
- 2 ½" thread
- 3 Adjustment screw
- 4 Sensor head

1. Seal the PBCOver reverse running protection with Teflon tape on the ½" thread.
2. Screw into the measurement fitting or tap (use a 36 mm wrench above the thread).
3. Slide the sensor to the rear of the pipe.
4. Align to the pipeline and note the flow direction (see arrow).
5. After adjusting the sensor, tighten the adjustment screw clockwise by hand.

If the sensor is inserted has to be removed for cleaning, inspection or recalibration:

1. Unscrew the sensor adjustment screw (anti-clockwise).
2. Hold the sensor in place.
3. Press the sensor adjustment screw downwards lightly against the spring force until the reverse running protection yields.
4. Pull the sensor back to the end stop.
5. Close the measurement fitting or tap, loosen the PBCOver using the 36 mm wrench and counterlock the fitting.

4.2. Electrical connection

The instrument may only be installed by a qualified electrician. Follow the national and international regulations regarding the installation of electro-technical systems. The voltage supply is to be laid out in accordance with EN50178, SELV, PELV. To meet the "limited voltage" requirements according to UL 508, the instrument must be supplied from a galvanically isolated source and protected against short-circuits by means of an overcurrent device.

Four-wire pin assignment (not an accessory)

If the optional connecting cable for electrical isolation is not used, then the following assignments apply.

Pin assignment on the connector (M12x1)

Pin no.	Wire colour	Assignment
1	Brown	+L (18...30V DC)
2	White	OUT2
3	Blue	0 V DC (GND)
4	Black	OUT1

1 x switching output, 1 x analogue output (condition on delivery)

The **OUT1** output is used as a PNP signal output (pulse) and the **OUT2** output is used as an analogue output. This is the configuration in which the sensors are delivered.

Pin assignment on the instrument

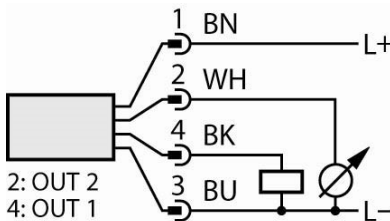

Pin assignment on the cable connector

Pin no.	Wire colour
1	BN (brown)
2	WH (white)
3	BU (blue)
4	BK (black)

2 x switching outputs

Both of the available **OUT1** and **OUT2** outputs are each used as a PNP signal output (pulse).

Pin assignment on the instrument

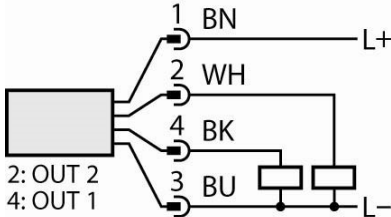



Five-wire pin assignment (accessory)



If the optional connecting cable for electrical isolation is used (☞ Connecting cable, page 16), then the following assignments apply.

Wire colour	Assignment
Brown	+L (19 to 30 V DC) sensor supply
Pink	+ potential-free pulse output (collector) OUT1
White	- potential-free pulse output (emitter) OUT1
Green	OUT2
Black	0 V DC (GND)

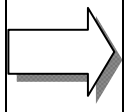
The potential-free pulse output **OUT1** is specified for this connecting cable as follows:

Line type	LiYCY
Length	5 m
Switching capacity	500 mA
Max. switching voltage	36 V
Min. switching voltage	5 V
Switch contact resistance	0.21 Ohm
Insulation voltage	5.3 kV
Protected against polarity reversal	Yes

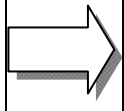
	<ul style="list-style-type: none">• So that the compressed air meter can display the correct volumetric flow, the inner pipe diameter must be set in the menu. <p> Adjustable parameters, page 32, menu item dIA.</p>
---	--

	<ul style="list-style-type: none">• For the compressed air meter to output the measuring values as accurately as possible as an analog value, the analog output must be scaled. <p> Adjustable parameters, page 32, menu items ASP and AEP.</p>
---	---

5 Operation

Thermal mass flow sensor

Familiarise yourself with the operation and programming of the sensor. The sensor is calibrated ex factory and provided with default settings for each nominal width. Do not inadvertently change these.

5.1. Operation and display elements

The following illustration shows the control and display unit of the sensor from above.

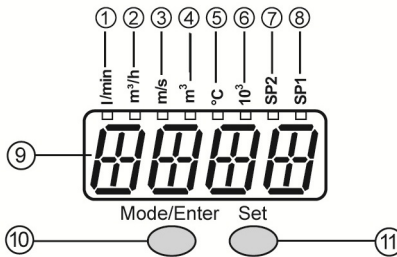

Number	Type	Description
1	Green LED	Volumetric flow rate [m^3/min] (LED l/min and LED 10^3 lights up)
2	Green LED	Flow rate [m^3/h]
3	Green LED	Average speed [m/s]
4	Green LED steady flashing	Current consumption quantity since the last reset [m^3] Consumption quantity before the last reset in m^3
5	Green LED	Gas temperature [$^{\circ}\text{C}$]
6	Green LED	10^3 = the displayed value must be multiplied by 1000
7	Yellow LED	SP2 = display of the switch status: LED illuminates when the respective output is switched through

Number	Type	Description
8	Yellow LED	SP1 = display of the switch status: LED illuminates when the respective output is switched through
9	Four-digit alphanumeric display	Display of the current volume flow Display of the average speed Display of the current consumption quantity Display of the parameters and parameter values Indication of the voltage level of the switching input or output
10	MODE / ENTER programming button [Mode/Enter]	Selection of the parameters and confirmation of the parameter values
11	SET programming button [Set]	Setting the parameter values Changing the display unit in run mode

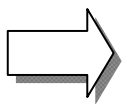

In general, the following applies as the display value:
LED 1 (l/min) x 1000 (LED 6 = 10^3 also illuminated) =
1 m³/min

From DN 150 upwards, the following applies: LED 2
(m³/h) display value x 1000 (LED 6 = 10^3 also
illuminated) = 10.0 (display value), corresponds to
10,000 m³/h

5.1.1. Types of operation

Run mode

After switching on the supply voltage, the instrument is in run mode. It carries out its measurement and evaluation functions and provides output signals according to the set parameters.

The display shows the current measurement values and the yellow LEDs show the switch status of the outputs.

The display unit can be temporarily changed (press the **[Set]** button briefly). After 15 seconds, the instrument returns to the display unit that was set in the **UNI** menu item.

The totaliser (consumption quantity counter) periodically (every 10 minutes) stores interim values as well as the amount of time elapsed of the automatic reset. After a drop in voltage, this value is available as the current status of the totaliser (the possible loss of data can amount to a maximum of 10 minutes).

Display mode

Display of the parameters and set parameter values

The instrument is switched to display mode by pressing **[Mode/Enter]** briefly. Internally, it remains operational.

The set parameter values can be read independent of this:

- The parameters are read through by pressing **[Mode/Enter]** briefly.
- The corresponding parameter value is displayed for approximately 15 seconds by pressing **[Set]** briefly. After a further 15 seconds, the instrument returns to run mode.

Programming mode

Setting the parameter values

The instrument is switched to programming mode if a parameter is selected and the **[Set]** button is pressed for longer than 5 seconds (the parameter value flashes, then is continuously increased).

Internally, the instrument also remains operational here.

It continues to carry out its monitoring functions with the existing parameters until the alteration is completed.

You can change the parameter value using **[Set]** and confirm by pressing **[Mode/Enter]**.

The instrument returns to measurement mode if no buttons are pressed for 15 seconds afterwards.

5.1.2. Menu overview

Meaning and function of abbreviations: see following chapter.

Character explanations: **S** = SET button, **M** = Mode/Enter button

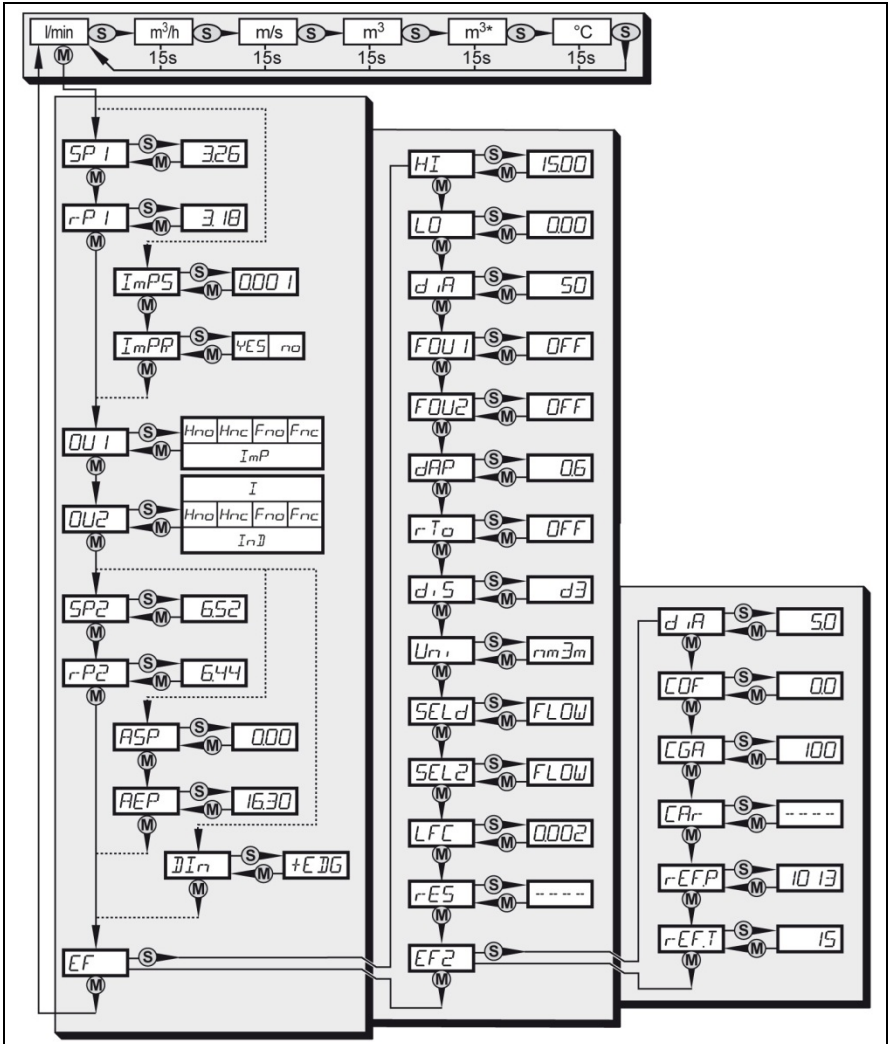

5.1.3. Programming

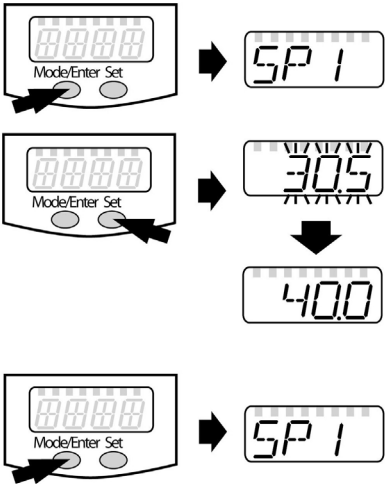
	<p>Press [Mode/Enter] until the desired parameter appears in the display.</p> <p>Press and hold [Set]. The current parameter value flashes for 5 seconds.</p> <p>It is then increased² (in steps by pressing once or continuously by pressing and holding the button).</p> <p>Press [Mode/Enter] briefly (confirmation). The parameter is displayed again and the new parameter value applies.</p>
<p>Changing further parameters:</p>	<p>Start again with step 1.</p>
<p>Ending programming:</p>	<p>Wait for 15 seconds or press [Mode/Enter] until the current measurement value appears again.</p>

Set the display unit (**Uni**) before you set the values for the **SPx**, **rPx**, **ASP** and **AEP** parameters. In this way, rounding up/down errors are avoided during the internal conversion into other units and the exact values required are provided. Condition at delivery: **Uni = nm3h**.

If no button is pressed for 15 seconds during the setting process, the instrument returns to the run mode with unchanged values.

The instrument can be electronically locked so that unintentional false entries are avoided: Press both programming buttons in run mode until **LOC** is displayed.

To unlock, press the buttons until **uLOC** is displayed.

² Lowering the value: Allow the display to run through to the maximum setting value. After this, the run-through starts again from the minimum setting value.

Condition at delivery: Not locked.

When the instrument is locked, **LOC** is shown briefly in the display if an attempt is made to change the parameter values.

5.1.4. Adjustable parameters

Representation in display	Description
SPx (SP1, SP2)	<p>Switch point 1/2</p> <p>Upper limit value at which the output changes its switch status.</p> <p>Only active if OU2 = Hno, Hnc, Fno or Fnc.</p>
rPx (rP1, rP2)	<p>Return switch point 1/2</p> <p>Lower limit value at which the output changes its switch status.</p> <p>rPx is always smaller than SPx. Values can only be entered which are lower than SPx.</p> <p>When the switch point is changed, the return switch point changes with it (the interval between SPx and rPx remains constant). If the interval is larger than the new switch point, then it is reduced automatically (rPx is set to the minimum setting value). rP2 is only active when OU2 = Hno, Hnc, Fno or Fnc.</p>
ImPS	<p>Output 1 as pulse output</p> <p>Only active if OU1 = ImP.</p>
ImPR	<p>Configuring quantity monitoring through pulse output</p> <p>Select ImPR and set to YES.</p> <p>Pulse repetition is active. Output 1 emits a counting pulse each time the value set in ImPS is reached.</p> <p>Configure the quantity monitoring using the preset counter.</p> <p>Select ImPR and set to NO.</p> <p>Pulse repetition is not active. The output switches ON when the value set in ImPS is reached. It remains switched until the counter is reset.</p> <p>☞ Setting the preset counter / pulse value (ImPS).</p>

Representation in display	Description
OU1	Configuration for output 1 5 functions can be set: Hno = Hysteresis function / normally open (NO) Hnc = Hysteresis function / normally closed (NC) Fno = Window function / normally open (NO) Fnc = Window function / normally closed (NC) Output signal for consumption quantity: ImP = Pulse output
OU2	Configuration for output 2 6 functions can be set: Output signals for flow measurement: Hno = Hysteresis function / normally open (NO) Hnc = Hysteresis function / normally closed (NC) Fno = Window function / normally open (NO) Fnc = Window function / normally closed (NC) I = Analogue signal (4 to 20 mA) InD = digital input for external reset signal. Configuration via menu item DIIn
ASP	Analogue starting point Measurement value at which 4 mA is output. ASP is only active when OU2 = I .
AEP	Analogue end point Measurement value at which 20 mA is output. Minimum distance between ASP and AEP = 25 % of the final measuring range value. AEP is only active when OU2 = I .

Representation in display	Description
DIn	<p>Digital input</p> <p>+EDG = rising edge -EDG = falling edge HIGH = High level LOW = Low level</p> <p>When the set signal is detected at the output, the totaliser is zeroed (and the current value is saved - flashing value)</p> <p>Only active if OU2 = In.D</p>
EF	<p>Extended functions</p> <p>This menu point contains a submenu (EF2) with further parameters. To access these parameters, briefly press the [Set] button.</p>
HI LO	<p>Min/max flow memory</p> <p>HI: Display of the highest flow value measured LO: Display of the lowest flow value measured</p> <p>Clearing the memory: Press [Mode/Enter] until HI or LO appears. Press [Set] and hold it until ---- appears. Now press [Mode/Enter] briefly.</p> <p>It is a good idea to clear the memory as soon as the instrument is used for the first time under normal working conditions.</p>
diA	<p>Display of the inner pipeline diameter</p> <p>Setting is only possible in the EF2 submenu. This may be locked in the event of parameterised (non-manipulable) sensors.</p>

Representation in display	Description
FOUx (FOU1, OU2)	<p>Behaviour of output x in the event of an internal error.</p> <p>Adjustable parameters:</p> <p>On = output x switches ON in the event of an error.</p> <p>Off = output x switches OFF in the event of an error</p> <p>(With both values (On, Off), the meter no longer runs in the event of an error</p> <p>OU = output 1 switches as defined with the parameters irrespective of any error.</p>
dAP	<p>Measurement value damping / damping constant in seconds</p> <p>From 0.0 to 1.0 in 0.2 increments</p> <p>dAP = 0; measuring value is completely undamped.</p>
rTo	<p>Resetting the quantity counter</p> <p>After a set period of time, the counter is automatically cleared and a new counting interval begins.</p> <p>The following time spans can be set:</p> <p>1h to 23h (reset after 1 to 23 hours)</p> <p>1d to 6d (reset after 1 to 6 days)</p> <p>1w to 8w (reset after 1 to 8 weeks)</p> <p>Additionally:</p> <p>OFF = reset after counter overflow (32 bit number overflow, i.e. overflow at 4,294,967.295 m³).</p> <p>rES.T = manual reset:</p> <p>The counter is manually cleared and a new counting interval begins:</p> <p>Press [Set] until rES.T appears.</p> <p>Now press [Mode/Enter] briefly.</p> <p>A manual reset can also be carried out when a time period for an automatic reset has been set.</p>

Representation in display	Description
diS	<p>Setting the display</p> <p>7 settings can be selected:</p> <p>d1 = update of measurement value every 50 ms</p> <p>d2 = update of measurement value every 200 ms</p> <p>d3 = update of measurement value every 600 ms</p> <p>The measurement value update affects only the display. It has no effect on the outputs.</p> <p>rd1, rd2, rd3 = display as with d1, d2, d3, but rotated by 180°</p> <p>OFF = display of the measurement value switched off in run mode.</p> <p>By pressing one of the buttons, the current measurement value is displayed for 15 seconds. Pressing the [Mode/Enter] button again opens the display mode.</p> <p>The LEDs also remain active when the display is switched off.</p>
Uni	<p>Display unit</p> <p>3 settings can be selected:</p> <p>nm3m = flow rate in m³/min (LED l/min and LED 10³ lights)</p> <p>nm3h = flow rate in m³/h, or m³/h x 1000</p> <p>ms = velocity in m/s</p> <p>Set the display unit before you set the values for the SPx, rPx, ASP and AEP parameters. In this way, rounding up/down errors are avoided during the internal conversion into other units and the exact values required are provided.</p>
SELd	<p>Standard measurement parameter on display Flow value, counter reading or medium temperature</p>

Representation in display	Description
SEL2	Standard measurement parameter for evaluation using output 2: <ul style="list-style-type: none"> • Limit value signal or analogue signal for flow • Limit value signal or analogue signal for temperature
LFC	Low flow cut-off Select LFC and set the limit value: Adjustment range: where LIM = 100%: 0.13% to 1% of meas. range final val. Where LIM = 50%: 0.26% to 2% of the current measuring value
rES	Reset to factory settings It is recommended to note down the individual settings before carrying out this function. Select rES . Press [Set] and hold it down until ---- is displayed. Press [Mode/Enter] briefly.
diA	Setting the inner pipe diameter Select diA and set the desired inner diameter for the nominal width. Adjustment range: 38...254 mm in 2 mm increments
COF	Parallel translation of the measurement curve with a fixed offset for adjustment to special pipe diameters. Standard 0
CGA	Setting a scale factor The scale factor is a multiplier used to change the gradient of the measurement curve. Standard: Scale factor = 112% Select CGA and set the desired scale (proportional) factor: Adjustment range: 60...140 % in 1 % increments
CAr	Reset to factory settings for the scale factor It is recommended to note down the individual settings before carrying out this function. Select CAr . Press [Set] and hold it down until ---- is displayed. Press [Mode/Enter] briefly.

Representation in display	Description
rEF.P	Standard pressure; measurement and display values for flow correspond to this value. Select rEF.P and set the desired standard pressure: Adjustment range: 950...1050 hPa in 1 hPa increments Standard: to 1013 hPa
rEF.T	Standard temperature; measurement and display values for flow correspond to this value. Select rEF.T and set the desired standard temperature: Adjustment range: 0...25 °C in 1 °C increments Standard 15 °C

5.1.5. Setting the preset counter / pulse value (ImPS)





The instrument has seven adjustment ranges:

	LED	Display	Value	Resolution
1	④	0.001 ... 9.999	0.001 to 9999 m ³	0.001 m ³
2	④	10.00 ... 99.99	10.00 to 99.99 m ³	0.01 m ³
3	④	100.0 ... 999.9	100.0 to 999.9 m ³	0.1 m ³
4	④	1000 ... 9999	1000 to 9999 m ³	1 m ³
5	④+⑥	10000 ... 99999	10000 to 99990 m ³	10 m ³
6	④+⑥	100000 ... 999900	100000 to 999900 m ³	100 m ³
7	④+⑥	1000000	1000000 m ³	

Setting procedure: ④ Set **OU1** to **ImP**.

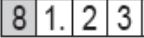
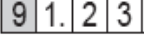
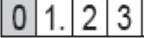
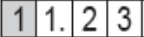
- Press **[Mode/Enter]** until **ImPS** is displayed.
- Press and hold **[Set]**.
- The current numerical value flashes for 5 seconds, then the first digit is active (digit flashes, can be changed).
- Set the desired value as specified in the following table.
- First select the desired adjustment range (1, 2, 3 etc.).
- Enter the number from left (first digit) to right (fourth digit).
- Press **[Mode/ Enter]** briefly when all four digits are set.

As soon as the first digit flashes, there are three options (flashes on grey background):

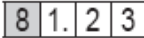
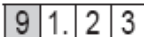
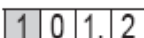
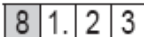
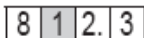
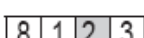
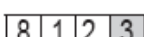
<p>Press [Set] briefly once each time.</p>	<p>The flashing digit is increased. 0 is displayed after 9.</p> <div style="text-align: right; margin-bottom: 10px;">  </div> <p>[Set] pressed once </p> <p>[Set] pressed once </p> <p>[Set] pressed once </p>
<p>Press and hold [Set].</p>	<p>The flashing digit is increased. 0 is displayed after 9 and the next digit to the left is active.</p> <div style="text-align: right; margin-bottom: 10px;">  </div> <p>[Set] held down </p> <p>[Set] still held down </p> <p>If digit 1 is changed in this way, then the display changes to the next highest adjustment range. 10 is displayed after 9, the decimal point is moved one space to the right or the LED display changes.</p> <div style="text-align: right; margin-bottom: 10px;">  </div> <p>[Set] held down </p> <p>[Set] still held down </p>
<p>Wait for 3 seconds (no buttons pressed).</p>	<p>The next digit to the right flashes (now active).</p> <div style="text-align: right; margin-bottom: 10px;">  </div> <p>No button pressed, after 3 seconds </p> <p>After 3 seconds </p> <p>After 3 seconds </p>

	<p>If the fourth digit flashes for 3 seconds without changing, then digit 1 is active when it is > 0.</p> <p>After 3 seconds 8 1 2 3</p>
	<p>If digit 1 is "0", then the display changes to the next lowest adjustment range. The decimal point is moved one space to the left or the LED display changes.</p> <p style="text-align: right;">0 1 2 3</p>
	<p>After 3 seconds 1 2 3 0</p> <p>Continue: Change digit 4 or wait for 3 seconds and set digit 1.</p> <p>After 3 seconds 1 2 3 0</p>

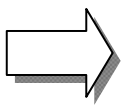

If **[Set]** is pressed down continuously, the display runs through all ranges and goes back to the start value when it reaches the end. Release **[Set]** briefly and start the setting again.

Hysteresis function (marked in grey in the figure)

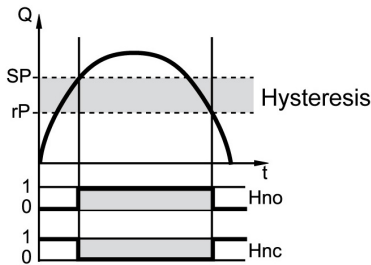

The hysteresis keeps the switch status of the output stable if the flow fluctuates around the nominal value.

With increasing flow, the output switches upon reaching the switch point (**SPx**).

If the flow decreases again, the output only switches back when the return switch point (**rPx**) is reached.

The hysteresis is adjustable:

First the switch point is determined, then the return switch point at the desired distance.

Window function

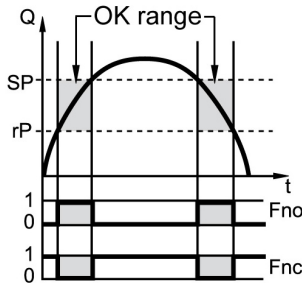

The window function allows a defined OK range to be monitored.

If the flow fluctuates between switch point (**SPx**) and return switch point (**rPx**), the output is switched through (window function/NO contact) or opened (window function/NC contact).

The size of the window is adjustable by the distance between **SPx** and **rPx**.

SPx = upper value; **rPx** = lower value.

Scaling the measuring range

- With the analogue starting point parameter (**ASP**), you determine at which measurement value the output signal is 4 mA.
- With the analogue end point parameter (**AEP**), you determine at which measurement value the output signal is 20 mA.

Minimum distance between **ASP** and **AEP** = 25 % of the final measuring range value (**MEW**).

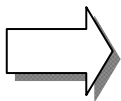
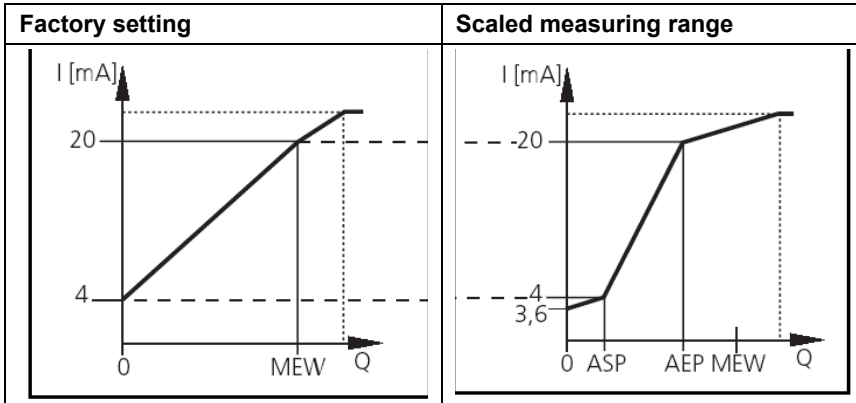

The analogue end point (AEP) varies according to the selected parameters (inner diameter, standard temperature, standard pressure and scale factor).

The output signal is between 4 and 20 mA in the set measuring range. Further signals are:

- Flow above the measuring range: Output signal > 20 mA
- Flow below the measuring range: Output signal between 3.6 and 4 mA.

6 Cleaning the sensor

You must clean the sensor:

- Before each calibration/inspection
- Regularly during operation

You can remove the sensor and clean it manually.



- Only clean the sensor with approved cleaning agents.
 - Do not use any abrasive cleaning agents. These can lead to irreparable damages to the sensor.
 - Carry out a new inspection after cleaning, as required.
-

6.1. Cleaning agents

For cleaning the sensor, use agents containing surfactants (alkaline) or water-soluble organic solvents (e.g. ethanol).

Isopropanol is recommended for cleaning various contamination, especially greases and oils.

6.2. Calibration

Because of contamination (e.g. oil, water, particles), an annual recalibration of the sensor is recommended, and one must take place at least every 24 months. This is mandatory for accounting purposes.

7 Troubleshooting

7.1. Replacing damaged parts



Damages to the compressed air counter that affect the pressure integrity may only be remedied by authorised personnel.

After each repair, the technical data of the specifications must be checked by authorised personal, e.g. pressure test.

Replace all other damaged parts immediately. Contact your supplier for more details on ordering.

7.2. Replacing O-rings and seal rings

- Keep the sealing surfaces clean
- Remove any encrusted residues from time to time
- In the event of leakage, contact your supplier



Danger of the medium escaping!

Replacement of the seals may only be performed by authorised personnel.

7.3. Error messages

These error messages are shown even when the display is switched off.

Display	Explanation
OL	Recording range exceeded (Flow > 120 % of the final measuring range value)
SC 1	Flashing: Short-circuit in switch output 1 ³
SC 2	Flashing: Short-circuit in switch output 2 ³
SC	Flashing: Short-circuit in both switch outputs ³
Err	Flashing: Malfunction in probe

³ The affected output is switched off as long as the short-circuit lasts.

