



## 20W DALI-2 LED Driver with Smooth Dimming to 1%

### ECOdrive

Programmable digital ECOdrive LED driver providing standard LED fixtures with the smoothest flicker-free dimming to 1% light output, delivering value to any application. The LED driver is compatible with the DALI-2 lighting control protocol, and works seamlessly together with LED modules, controls and intelligent luminaire elements.

### Product offering



### ECOdrive 260/S

Part number (P/N)	EC0260S2
Product description	ECOdrive, 20W, DALI-2, 1 control channel, constant current, 1x 55V output, side feed, metal square

### Features & benefits

Natural dimming	Dim to 1%, smooth brightness changes, excellent flicker performance, adaptable dimming curves, configurable minimum dimming level
LEDcode	LEDcode2 connects to integrated digital accessories, supports location-based IoT applications and enables wired and wireless lighting control through LEDcode peripheral devices
Programmable	Fine-tune your driver for any application
Performance	Universal input voltage range, low inrush current and total harmonic distortion (THD), high power factor and efficiency
Camera compatibility	Hybrid HydraDrive technology is proven to work in TV studios and security camera environments

## Programming tools

Programming interface	<a href="#">TOOLbox pro (TLU20504)</a>
Programming cable set	<a href="#">TOOLbox pro to LED driver, programming cable, 5pcs (TLC03051)</a>
Programming Hand-held, Touch-and-Go	<a href="#">PJ0050HH1</a>
Programming jig	<a href="#">PJ0300S1</a>
Programming software	<a href="#">FluxTool</a>

## Warranty

Warranty period	<a href="#">General Terms and Conditions</a>
-----------------	--

## Order number configurator

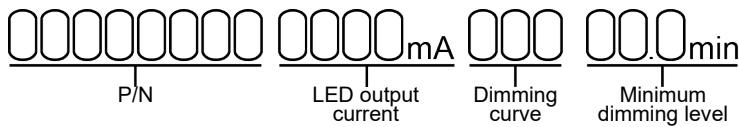

P/N	LED driver part number
LED output current	Enter value in 1mA increments, e.g. "811" for 811mA
Dimming curve	"LOG" for logarithmic (default) "LIN" for linear
Minimum dimming level	Leave blank for default minimum dimming level of 1.0%. Specify in 0.1% increments, e.g. "10.5" for 10.5%.

---

### Input characteristics

---

Nominal input voltage range AC	120 - 250V (ENEC), 120 - 277V (UL)
Absolute input voltage range AC	120 - 277V
Nominal input voltage range DC	120 - 250V
Maximum input current AC	0.2A @ 120V 0.9A @ 277V
Input frequency range	50 - 60Hz
Efficiency at full load	85%
Power factor at full load	> 0.95
THD at full load	< 20%
Maximum inrush current AC	<100mA <sup>2</sup> s @ 120V <100mA <sup>2</sup> s @ 277V
Surge protection	2kV differential mode (DM) 2kV common mode (CM)
Maximum standby power	< 0.5W

---

**Output characteristics**

Maximum LED output power	20W
Number of LED outputs	1 (UL Class 2)
Programmable LED output current range	150 - 1400mA
LED output type	Programmable in 1mA increments within specified current range
LED output current tolerance	+/- 5% at programmed LED output current
LED output voltage range	2 - 55V

Operating window

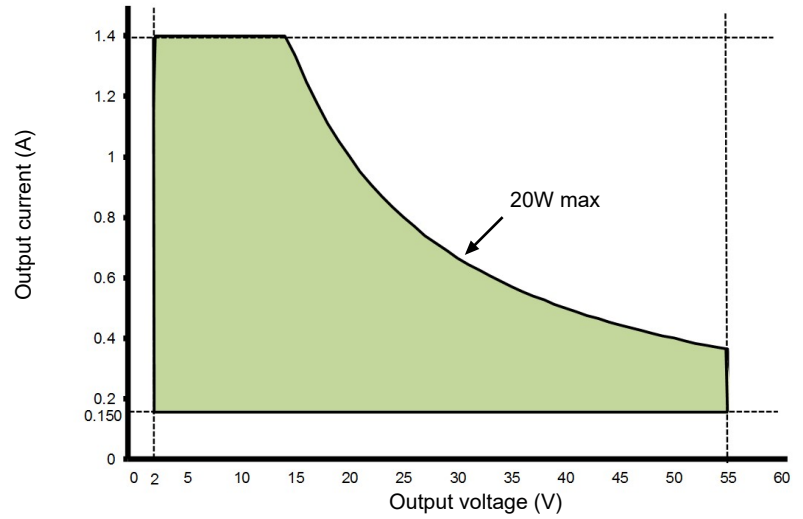

### Control characteristics

Control channels	1
Control protocol	DALI-2 Device Type 6 LEDcode2
Dimming range	100% - 1%
Dimming curve options	Logarithmic (default) Linear
Dimming method	Hybrid HydraDrive
Time delay to standby	<30s

### Dimming curves

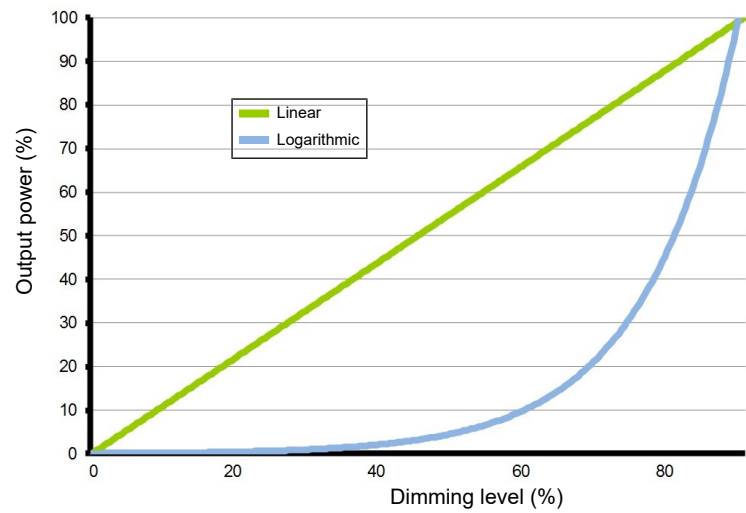

**Performance**

Typical efficiency vs load

Tested with a load of 17 LEDs in series, programmed for 350mA and at 25 °C ambient temperature. The measurements below 20W were performed by dimming the light output.

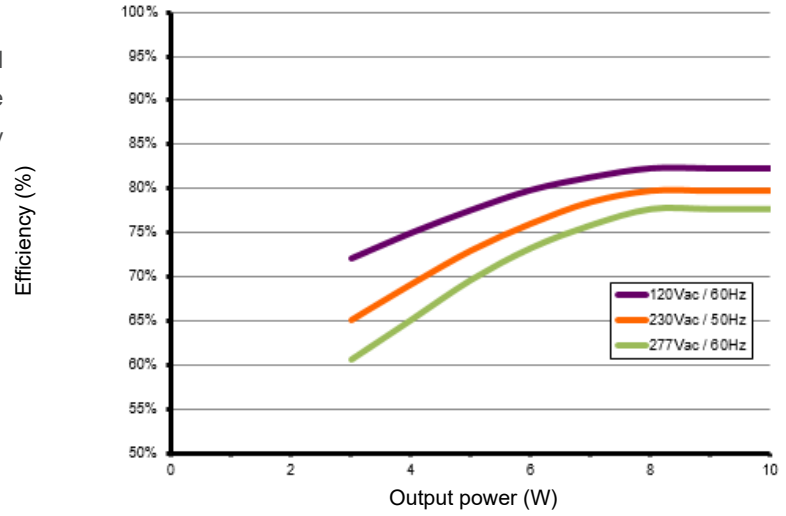

Typical power factor vs load

Tested with a load of 17 LEDs in series, programmed for 350mA and at 25 °C ambient temperature. The measurements below 20W were performed by dimming the light output.

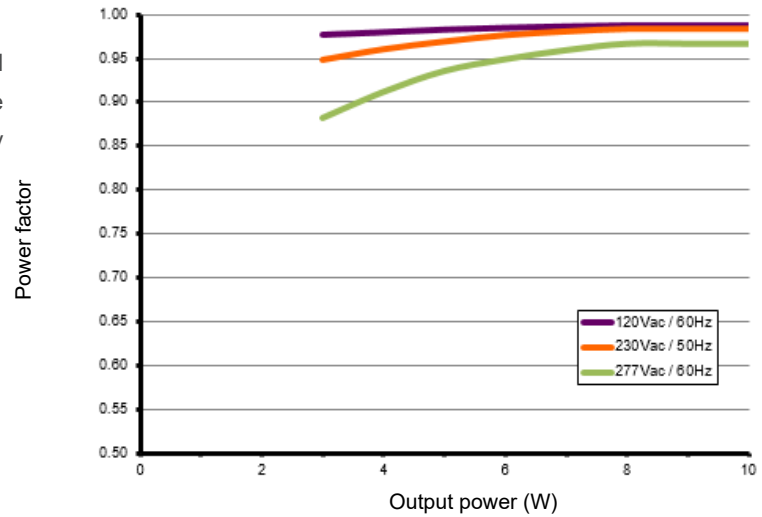

Typical THD vs load

Tested with a load of 17 LEDs in series, programmed for 350mA and at 25 °C ambient temperature. The measurements below 20W were performed by dimming the light output.

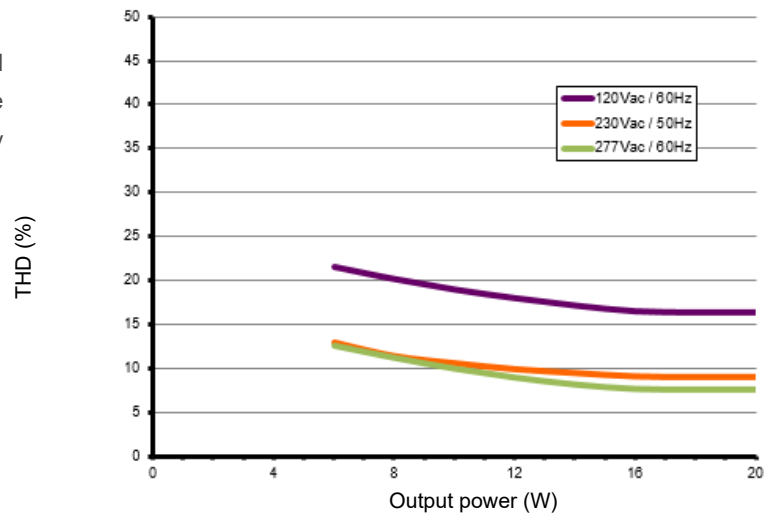

Typical flicker performance

Typical flicker percent as a function of frequency, measured across the dimming range. The results are overlaid with the low-risk (yellow) and no observable effect (green) levels as defined in IEEE P1789.

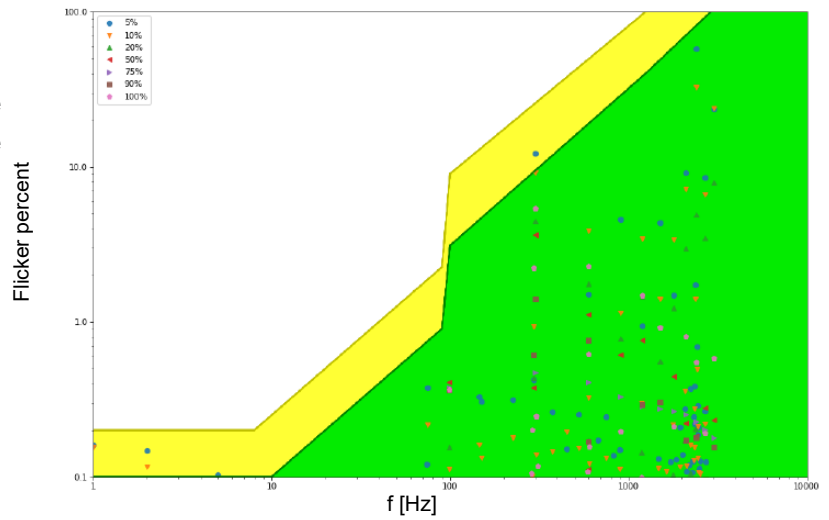

**Environmental conditions**

Operating ambient temperature (Ta) range      -20 °C to +50 °C

Maximum operating case temperature (Tc max)      75 °C

Lifetime      50,000 hours at a maximum case temperature (Tc) of 75 °C

UL Type TL      Measured Tref: 56 °C  
Maximum allowed Tref: 87 °C  
Measured at 1400mA

TC point location

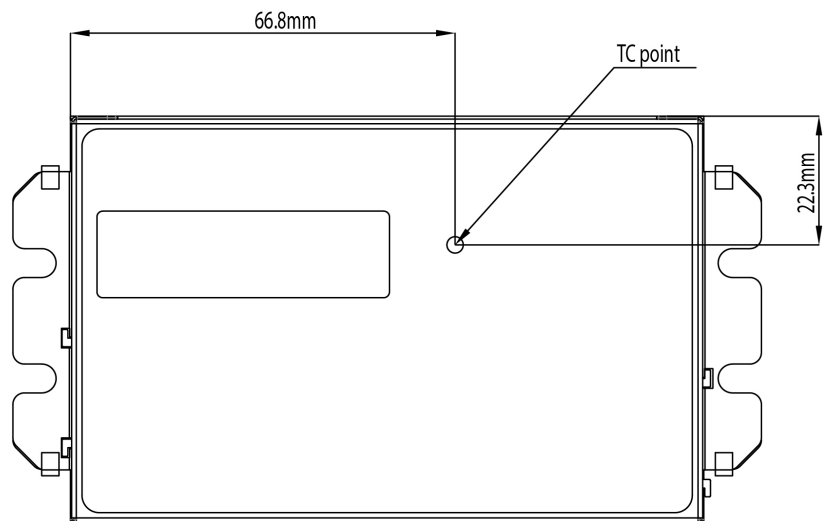

## LED driver protection

Thermal	The LED output current is decreased whenever the internal LED driver temperature exceeds factory preset temperature. The LED output current is increased again once the internal LED driver temperature drops below this internal temperature threshold. If the internal LED driver temperature continues to increase, despite a decrease in output current, the LED driver will shut down.
LED output short circuit	The LED output current is cut off whenever the LED driver detects a short-circuit. The LED driver will attempt a restart every 400ms after a short-circuit is detected.
LED output overload	The LED driver decreases the LED output current sequentially, until it reaches its maximum rated power, whenever a load that exceeds the LED driver's maximum rated power is connected to the LED output.
Reverse polarity	The LED driver will not yield any current if the polarity of the load on the LED output is reversed. This situation will not damage the LED driver but may damage the LED load.

## LED protection

Thermal protection LED	An external NTC thermistor, which is placed on a PCB near the LEDs, can be connected to the driver via the LEDcode/NTC terminals. The output current to the LEDs is then decreased by 75% whenever the NTC exceeds a maximum allowable temperature, which is specified by the user in the FluxTool software. The default NTC temperature limit is set to 70 °C.
Thermistor value	47kΩ
Suitable thermistors	Leaded: Vishay, P/N 238164063473 Screw: Vishay, P/N NTCASCWE3473J





Length excluding flanges (L3)	typical: 110.0 mm / 4.33 in maximum: 110.2 mm / 4.34 in
-------------------------------	--

Center to center mounting hole distance (L2)	20 mm / 0.79 in tolerance: 0.5 mm / 0.02 in
--	--

3D files available on product web page	IGS STEP
--	-------------

Weight	285.5 g
--------	---------

Mounting torque	Not to exceed 0.5Nm
-----------------	---------------------

### Packaging

Length x Width x Height	500 x 310 x 190 mm / 19.7 x 12.2 x 7.5 in
-------------------------	---

Weight (including products)	13.3 kg
-----------------------------	---------

Products per box	48 pcs
------------------	--------

### Connector layout

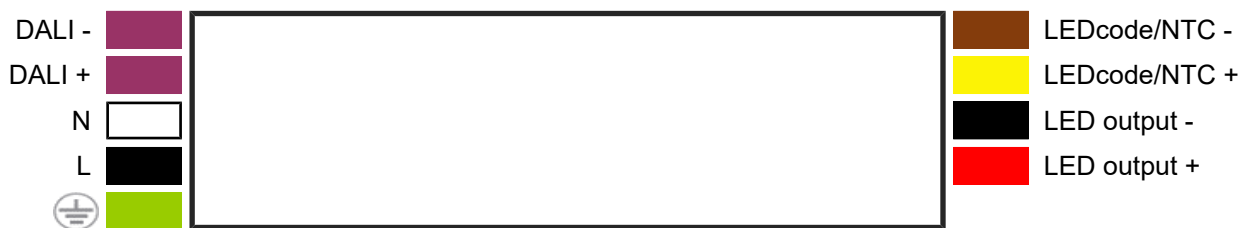

### Input wiring specifications

Connector type	push-in terminals
----------------	-------------------

Connector supplier and series	Wago 250 series
-------------------------------	-----------------

Wire type	solid or stranded copper
-----------	--------------------------

Wire core cross section	0.5 - 1.5mm / AWG 20 – 16
-------------------------	---------------------------

Wire strip length	9.0mm / 11/32"
-------------------	----------------

**Output wiring specifications**

Connector type	push-in terminals
Connector supplier and series	Wago 253 series
Wire type	solid or stranded copper
Wire core cross section	0.5 - 1.5mm / AWG 20 – 16
Wire strip length	9.0mm / 11/32"
Maximum remote mounting distance of LED load	AWG 20 (0.52 mm <sup>2</sup> ) - 14 m / 46 ft AWG 19 (0.65 mm <sup>2</sup> ) - 18 m / 59 ft AWG 18 (0.82 mm <sup>2</sup> ) - 22 m / 72 ft AWG 17 (1.04 mm <sup>2</sup> ) - 28 m / 92 ft AWG 16 (1.31 mm <sup>2</sup> ) - 36 m / 118 ft

**Automatic circuit breakers (MCB)**

Maximum loading	MCB type	B10	B13	B16	C10	C13	C16
	Number of LED drivers	33	43	53	33	43	53

## Standards and compliance

UL, recognized component	UL 1310 UL 8750 (Class 2 output). Type TL LED driver.
ENEC safety	EN 61347-1 EN 61347-2-13 (Emergency lighting)
ENEC performance	EN 62384
Conducted emissions	EN 55015, Class B
Radiated emissions	EN 55015, Class B
Radio disturbance characteristics	EN 55022
Harmonic current emissions	EN 61000-3-2
Electromagnetic immunity	EN 61547
DALI-2	IEC 62386-101 Edition 2.0, IEC 62386-102 Edition 2.0, IEC 62386-207 Edition 1
Surge protection	IEC 61000-4-5 level 3: 2kV DM, 2kV CM @ 2 Ohm
Surge protection	ANSI 62.41 1991 category B1: 2.5kV DM, 2.5kV CM @ 30 Ohm DALI input: 0.5 kV DM, 1 kV CM surge
Restriction of hazardous substances	RoHS3 (Directives 2011/65/EU-2015/863/EU)

## Certifications



---

## Safety

---



Risk of electrical shock. May result in serious injury or death. Disconnect power before servicing or installing.



The LED driver may only be connected and installed by a qualified electrician. All applicable regulations, legislation, and building codes must be observed. Incorrect installation of the LED driver can cause irreparable damage to the LED driver and the connected LEDs.

Pay attention when connecting the LEDs: polarity reversal results in no light output and often damages the LEDs.



LED drivers are designed and intended to operate LED loads only. Powering non-LED loads may push the LED driver outside its specified design limits and is, therefore, not covered by any warranty.



eldoLED products are designed to meet the performance specifications as outlined at certain operating conditions in the data sheet. It is the responsibility of the fixture manufacturer to test and validate the design and operation of the system under expected and potential use cases, including faults.



Please observe voltage drop over long cable lengths. Longer cable lengths increase EMI susceptibility.



Product renderings and dimensional drawings are generic for the housing type. Product label, connector type and quantity may vary.

---

---

### Europe, Rest of World

eldoLED B.V.  
Science Park Eindhoven 5125  
5692 ED Son  
The Netherlands

E: [info@eldoled.com](mailto:info@eldoled.com)  
W: [www.eldoled.com](http://www.eldoled.com)

---

### North America

eldoLED America  
One Lithonia Way  
Conyers, GA 30012  
USA

E: [info@eldoled.com](mailto:info@eldoled.com)  
W: [www.eldoled.com](http://www.eldoled.com)

---