



Colour  
is our nature

## 50W DMX/RDM Full-Colour (RGBW) Dimmable LED Driver

### POWERdrive

POWERdrive AC's dynamic response can be tuned to fit any content - from exceptionally smooth fades in architecture to fast-paced video in entertainment. This constant current LED driver is DMX/RDM compatible, with a fully isolated DMX/RDM interface to all inputs and outputs.

### Product offering



### POWERdrive 50U-M4Z0X

Part number P/N	PW50U-M4Z0X1
Product description	POWERdrive AC, 50W, DMX/RDM, 4 control channels, constant current, 4x 55V outputs, side feed, long metal

### Features & benefits

Natural dimming	Dim to dark, smooth brightness changes, excellent flicker performance, adaptable dimming curves, configurable minimum dimming level
Programmable	4 x fully programmable, Class-2, constant current LED outputs which operate across a wide operating window
Performance	Universal input voltage range, low inrush current and total harmonic distortion (THD), high power factor and efficiency
Camera compatibility	Hybrid HydraDrive technology is proven to work in TV studios and security camera environments
DMX/RDM	DMX/RDM compatible full-color (RGBW) LED driver
Isolated DMX interface	Improved immunity against surge events and enhanced robustness against accidental mis-wiring

## Warranty

Warranty period [General Terms and Conditions](#)

## Input characteristics

Nominal input voltage range AC 120 - 250V (ENEC), 120 - 277V (UL)

Absolute input voltage range AC 108 - 305 V

Nominal input voltage range DC 120 - 250V

Maximum input current AC  
0.5A @ 120V  
0.26A @ 230V  
0.22A @ 277V

Input frequency range 50 - 60Hz

Efficiency at full load 85%

Power factor at full load >0.95

THD at full load <20%

Maximum inrush current AC  
<100mA<sup>2</sup>s @ 120V  
<100mA<sup>2</sup>s @ 230V  
<100mA<sup>2</sup>s @ 277V

Surge protection  
2kV differential mode (DM)  
2kV common mode (CM)

Maximum standby power <0.5W

**Output characteristics**

Maximum LED output power	50W
Number of LED outputs	4 (UL Class 2)
Programmable LED output current range	150 - 1400mA per LED output.  The cumulative current across all LED outputs shall not exceed 3400mA at any point in time during normal operation
LED output type	programmable in 1mA steps via DMX terminal and FluxTool
LED output current tolerance	+/- 5% at programmed LED output current
LED output voltage range	2 - 55V

Operating window

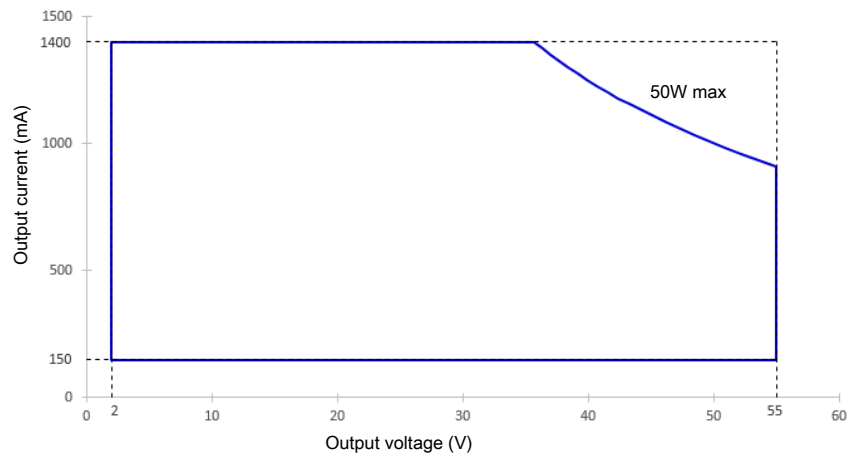

Startup time	< 500ms, see Design Guide for details
--------------	---------------------------------------

**Control characteristics**

Control channels 1 – 4 (default)

Multiple LED outputs can be mapped onto a single DMX group. For more details, see the Design Guide.

Control protocol DMX/RDM

Dimming range 100% - 0.1%

Dimming curve options  
 Logarithmic (default)  
 Linear  
 Soft-Linear  
 Square

Dimming method Hybrid HydraDrive

Dimming curves

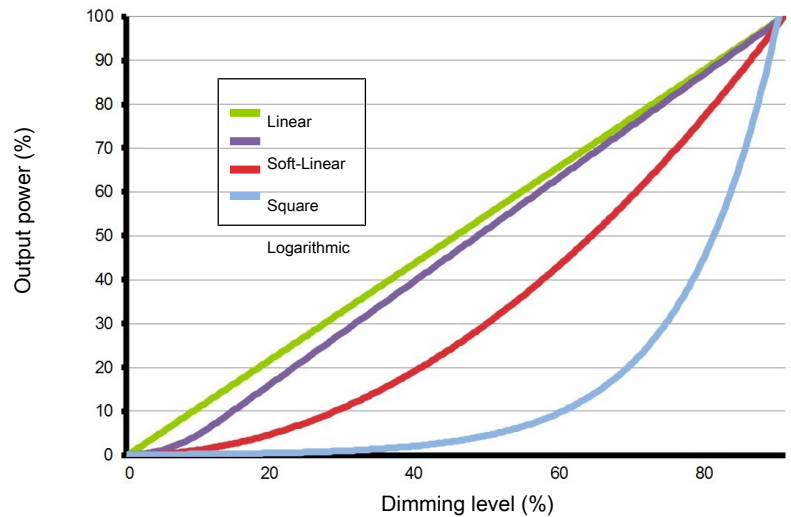

**Programming tools**

Programming interface [TOOLbox pro \(TLU20504\)](#)

Programming cable set [TOOLbox pro to LED driver, programming cable, 5pcs \(TLC03051\)](#)

Programming software [FluxTool](#)

## Performance

### Typical efficiency vs load

Tested with a load of 17 LEDs in series, programmed for 245mA and at 25 °C ambient temperature. The measurements below 50W were performed by dimming the light output.

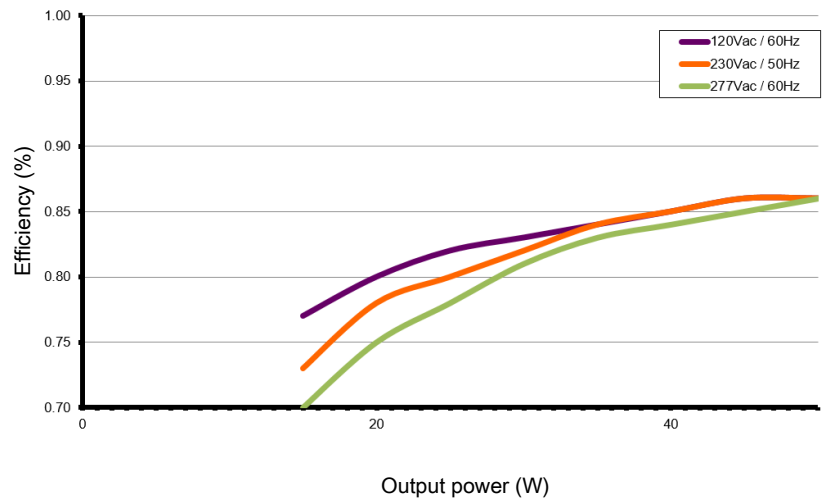

### Typical power factor vs load

Tested with a load of 17 LEDs in series, programmed for 245mA and at 25 °C ambient temperature. The measurements below 50W were performed by dimming the light output.

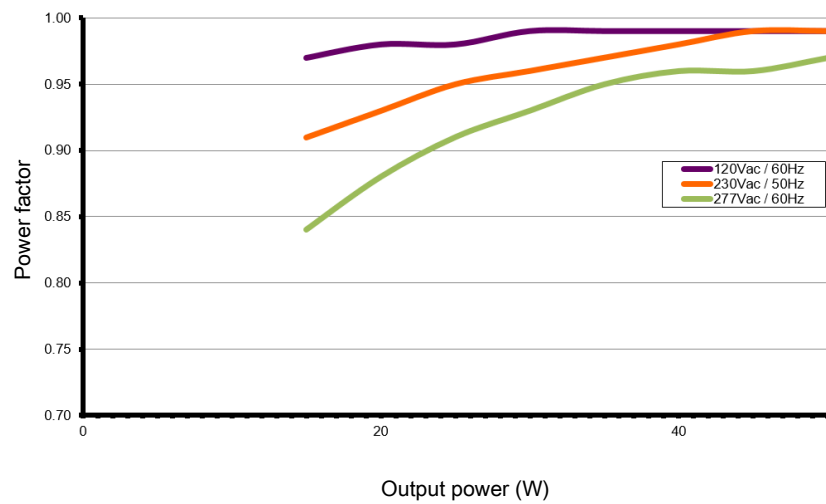

### Typical THD vs load

Tested with a load of 17 LEDs in series, programmed for 245mA and at 25 °C ambient temperature. The measurements below 50W were performed by dimming the light output.

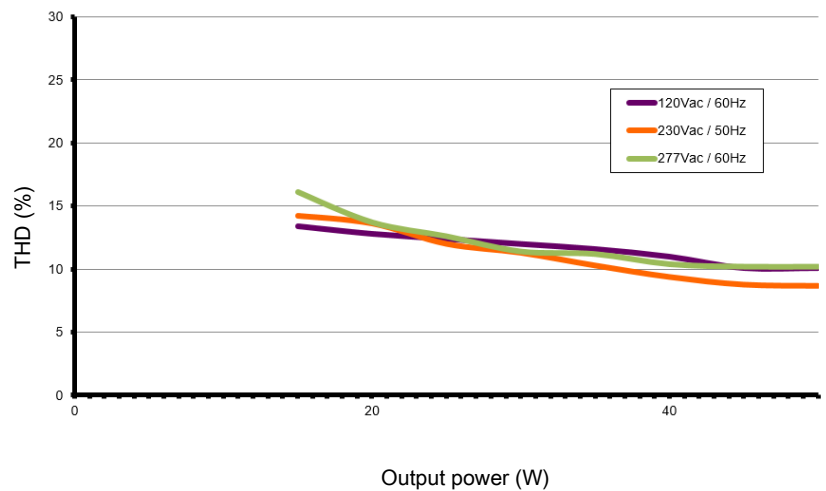

Typical flicker performance

Typical flicker percent as a function of frequency, measured across the dimming range. The results are overlaid with the low-risk (yellow) and no observable effect (green) levels as defined in IEEE P1789.

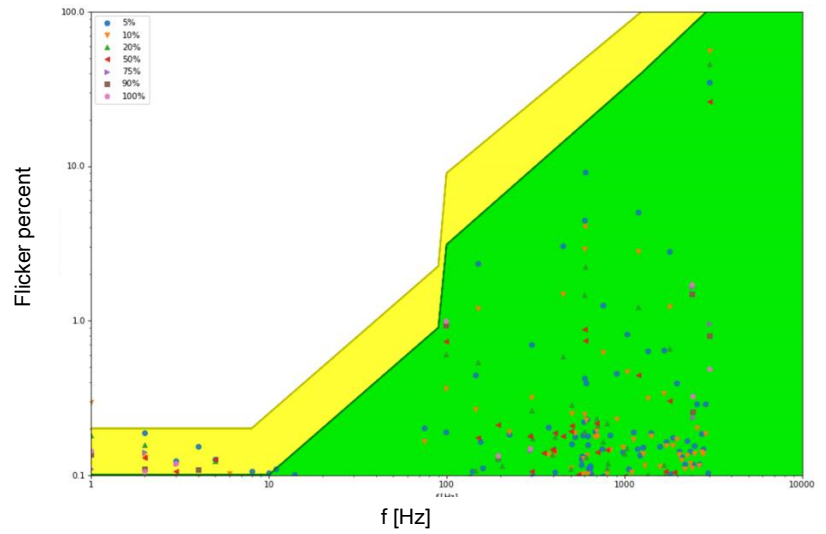

Environmental conditions

Operating ambient temperature ( $T_a$ ) range      -20 °C to +50 °C

Maximum operating case temperature ( $T_c$  max)      80 °C

Lifetime      50k hours at a maximum case temperature ( $T_c$ ) of 80 °C

$T_c$  point location

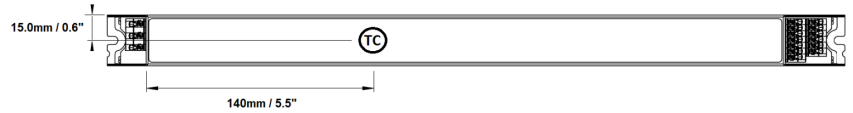

Acoustic noise – steady state      <24dBA (Class A)

**LED driver protection**

Thermal	The output current on all LED outputs is automatically decreased whenever the internal LED driver temperature exceeds a factory preset temperature. The LED output current is increased once the internal LED driver temperature drops below this internal temperature threshold. If the internal LED driver temperature continues to increase, despite a decrease in output current, the LED driver will eventually shut down.
LED output short circuit	The LED output current is cut off whenever the LED driver detects a short-circuit. The LED driver will attempt a restart every 400ms after a short-circuit is detected.
LED output open circuit	All LED outputs are turned off whenever the LED driver detects an open circuit on any one of the LED outputs. The LED driver will automatically attempt a restart every 400ms after an open circuit is detected.
LED output overload	The driver monitors the cumulative load across all LED outputs. Whenever this cumulative load exceeds the maximum output power rating of the LED driver, the output current on all LED outputs is sequentially scaled down until the cumulative load drops below the maximum output power rating of the LED driver.
Reverse polarity	The LED driver will not yield any current if the polarity of the load on the LED output is reversed. This situation will not damage the LED driver but may damage the LED load.

**LED protection**

Thermal protection LED	An external NTC thermistor, which is placed on a PCB near the LEDs, can be connected to the driver via the LEDcode/NTC terminals. The output current to the LEDs is then decreased by 75% whenever the NTC exceeds a maximum allowable temperature, which is specified by the user in the FluxTool software. The default NTC temperature limit is set to 70 °C.
Thermistor value	47kΩ
Suitable thermistors	Leaded: Vishay, P/N 238164063473 Screw: Vishay, P/N NTCASCWE3473J

**LED driver mechanical details**

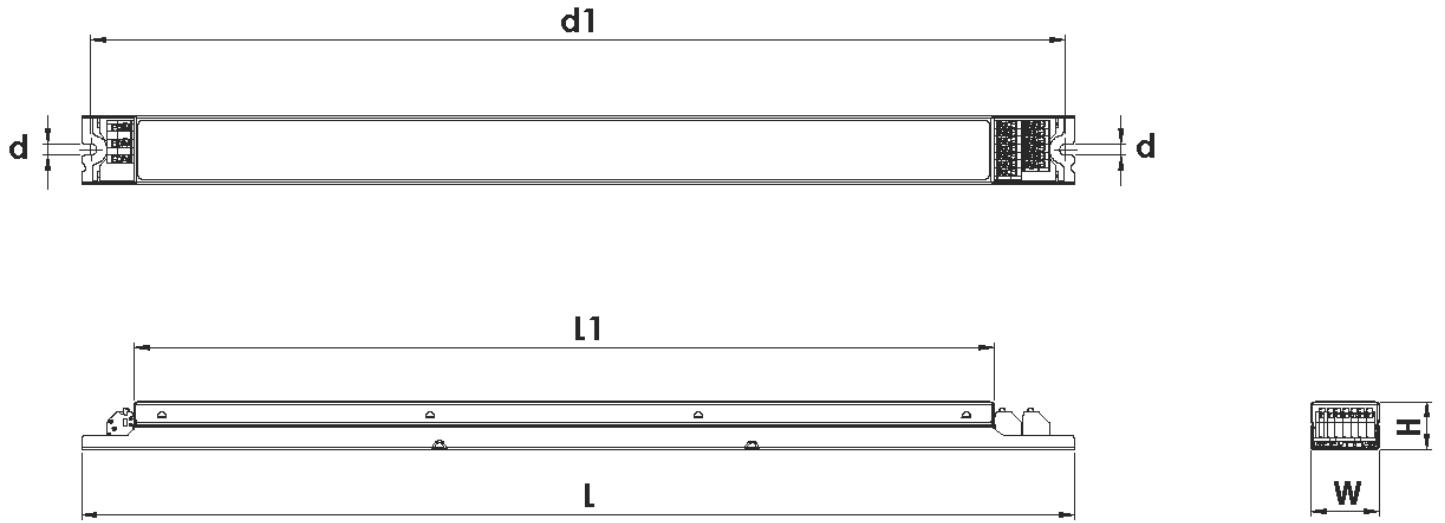

Length (L)	typical: 444 mm / 17.5 in maximum: 444.5 mm / 17.5 in
Width (W)	typical: 30 mm / 1.2 in maximum: 30.6 mm / 1.2 in
Height (H)	typical: 21 mm / 0.8 in maximum: 22.8 mm / 0.9 in
Mounting hole diameter (d)	5 mm / 0.20 in
Center to center mounting hole distance (d1)	typical: 436 mm / 17.2 in maximum: 436.5 mm / 17.2 in
Length excluding flanges (L1)	383 mm / 15.1 in
Weight	436 g

**Packaging**

Length x Width x Height	310 x 470 x 470 mm / 12.2 x 18.5 x 18.5 in
Weight (including products)	21.8 kg
Products per box	30 pcs



## Connector layout



## Wiring specifications

Connector type	push-in terminals
Connector supplier and series	Wago 250 / DECA MX522
Wire strip length	9mm (11/31in)
Wire core cross section	AWG 20-16, 0.5 – 1.5 mm <sup>2</sup> (mains, LED output, LEDcode) AWG 24-16, 0.2 – 1.5 mm <sup>2</sup> (DMX)
Wire Type	UL: solid (mains); solid or stranded (LED outputs, DMX, LEDcode) ENEC: solid or stranded

## Automatic circuit breakers (MCB)

Maximum loading	MCB type	B10	B13	B16	C10	C13	C16
Number of LED drivers (120Vac)		14	16	20	14	16	20
Number of LED drivers (230Vac)		26	30	38	26	30	38
Number of LED drivers (277Vac)		31	36	45	31	36	45

**Standards and compliance**

UL Listed, Class P	UL 1310 UL 8750 (Class 2 output)
ENEC safety	EN 61347-1 EN 61347-2-13 (Emergency lighting)
ENEC performance	EN 62384
Conducted emissions	EN 55015 FCC title 47 CFR part 15 class B
Radiated emissions	EN 55015 FCC title 47 CFR part 15 class B
Radio disturbance characteristics	EN 55022
Harmonic current emissions	EN 61000-3-2
Electrostatic discharge	EN 61000-4-2
RFE field susceptibility	EN 61000-4-3
Electrical fast transient	EN 61000-4-4
Surge immunity	EN 61000-4-5
Conducted radio frequency	EN 61000-4-6
Voltage dips	EN 61000-4-11
Electromagnetic immunity	EN 61547
DMX	ANSI E1.11 – 2008 (R2013), USITT DMX512-A ANSI E1.20 - 2010
Surge protection mains	IEC 61000-4-5 level 3: 2kV DM, 2kV CM @ 2 Ohm ANSI 62.41 1991 category B1: 2.5kV DM, 2.5kV CM @ 30 Ohm
Surge protection DMX	1kV CM
RCM	AS/NZS 61347.1, AS/NZS 61347.2.13
Restriction of hazardous substances	RoHS3 (Directives 2011/65/EU-2015/863/EU)
SVHC-list substances	REACH Art.33

---

### Certifications

---



Order number configurator

Standard

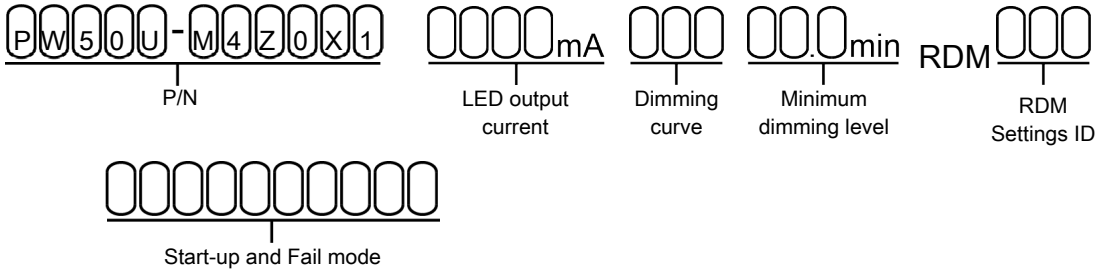

Custom current

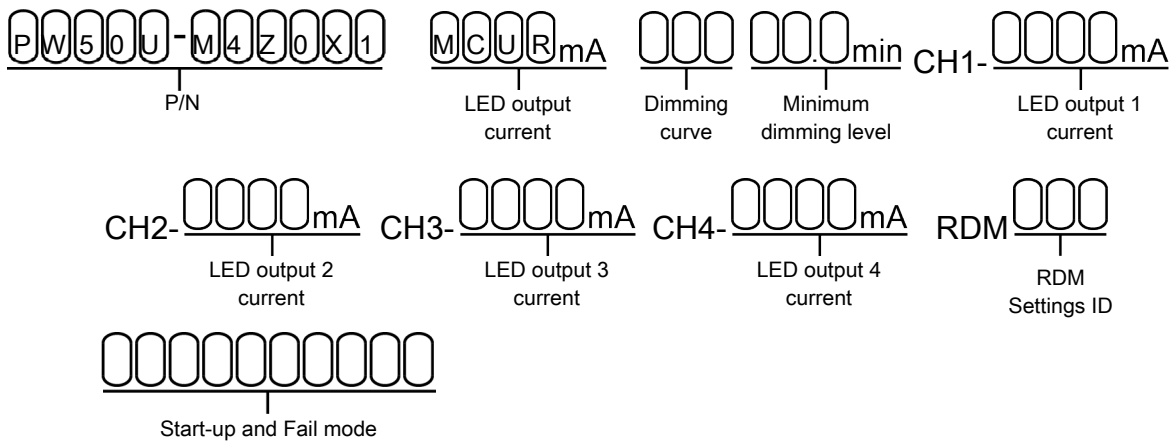

P/N	LED driver part number
LED output current	Enter value in 1mA increments, e.g. "811" for 811mA. The POWERdrive 50W/U driver is designed to deliver, by default, the specified output current on each LED output. If the output current is different per LED output, enter "MCUR" in LED output current and specify the differing output currents in LED Outputs 1/2/3/4.
Dimming curve	"LOG" for logarithmic (default) "LIN" for linear "SLN" for soft-linear "SQU" for square
Minimum dimming level	Leave blank for default minimum dimming level of 0.1%. Specify in 0.1% increments, e.g. "10.5" for 10.5%.

RDM Settings ID

The RDM Settings ID is a reference to a variety of RDM settings (e.g. Manufacturer ID, Device Model Description, RDM IDs) that are stored in the driver from the eldoLED factory. These settings cannot be changed by the user. RDM001 is the default RDM Settings ID and corresponds to the default eldoLED RDM settings. Customer-specific RDM settings can be programmed into the driver in the eldoLED factory. Contact your sales representative if custom settings are desired.

Default start-up and fail mode

Enter "ENTM" to start-up the driver at 20% and retain its last value with the loss of DMX (**default**).

To create a custom configuration, specify the start-up and DMX drop levels for all LED outputs using the format: S\_\_\_\_\_D\_\_\_\_\_, where S\_\_\_\_\_ defines the start-up level and D\_\_\_\_\_ defines the DMX drop level for LED outputs 1 - 4. Specify S\_\_\_\_\_DR if the last value must be retained when the DMX signal is dropped. The underscores in this custom configuration can be [0-9, F] corresponding to the option values in the table below. Make sure that the total output power and cumulative current of all LED outputs do not exceed the maximum ratings of the driver. For example specify S000FDR for an RGBW application that starts with only the 4<sup>th</sup> LED output (white) at 100% of the nominal drive current and retains the last value for every LED output when the DMX signal is dropped.

Selection	Description	Selection	Description
0%	0	60%	6
10%	1	70%	7
20%	2	80%	8
30%	3	90%	9
40%	4	100%	F
50%	5		

---

## Safety

---



Risk of electrical shock. May result in serious injury or death. Disconnect power before servicing or installing.



The LED driver may only be connected and installed by a qualified electrician. All applicable regulations, legislation, and building codes must be observed. Incorrect installation of the LED driver can cause irreparable damage to the LED driver and the connected LEDs.

Pay attention when connecting the LEDs: polarity reversal results in no light output and often damages the LEDs.



LED drivers are designed and intended to operate LED loads only. Powering non-LED loads may push the LED driver outside its specified design limits and is, therefore, not covered by any warranty.



eldoLED products are designed to meet the performance specifications as outlined at certain operating conditions in the data sheet. It is the responsibility of the fixture manufacturer to test and validate the design and operation of the system under expected and potential use cases, including faults.



Please observe voltage drop over long cable lengths. Longer cable lengths increase EMI susceptibility.



Product renderings and dimensional drawings are generic for the housing type. Product label, connector type and quantity may vary.

---

---

### Europe, Rest of World

eldoLED B.V.  
Science Park Eindhoven 5125  
5692 ED Son  
The Netherlands

E: [info@eldoled.com](mailto:info@eldoled.com)  
W: [www.eldoled.com](http://www.eldoled.com)

---

### North America

eldoLED America  
One Lithonia Way  
Conyers, GA 30012  
USA

E: [info@eldoled.com](mailto:info@eldoled.com)  
W: [www.eldoled.com](http://www.eldoled.com)

---