

**Ultrasonic proximity sensors**

**UNDK 20 (Sd = 400 mm)**

**sample drawing**

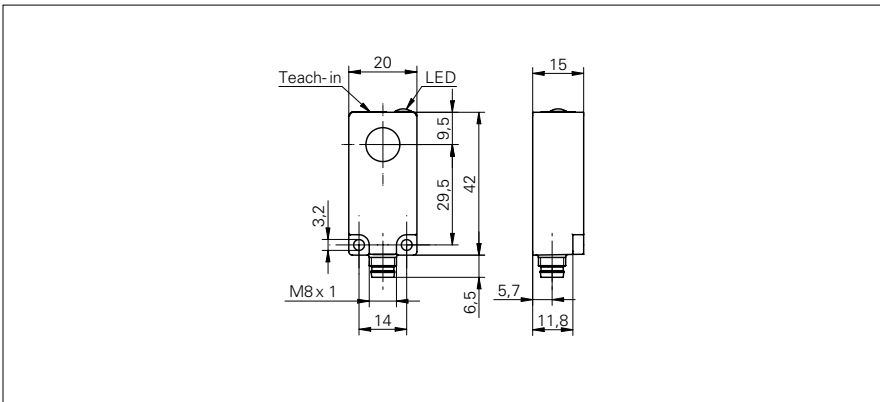

**general data**

scanning range Sd	40 ... 400 mm
scanning range far limit Sde	60 ... 400 mm
hysteresis typ.	4 % Sde
repeat accuracy	< 0,5 mm
temperature drift	< 0,18 % Sde/K
response time ton	< 25 ms
release time toff	< 25 ms
sonic frequency	290 kHz
adjustment	Teach-in
alignment aid	target indication flashing
output indicator	LED green

**sample picture**



**electrical data**

voltage supply range +Vs	12 ... 30 VDC
current consumption max. (no load)	35 mA
output current	< 200 mA
voltage drop Vd	< 2 VDC
residual ripple	< 10 % Vs
short circuit protection	yes
reverse polarity protection	yes

**mechanical data**

type	rectangular
housing material	polyester
width / diameter	20 mm
height / length	42 mm
depth	15 mm
connection types	connector M8

**ambient conditions**

operating temperature	-10 ... +60 °C
protection class	IP 67

**Ultrasonic proximity sensors****UNDK 20 (Sd = 400 mm)**

<b>order reference</b>	<b>output circuit</b>
<b>UNDK 20N6912/S35A</b>	NPN make function (NO)
<b>UNDK 20N7912/S35A</b>	NPN break function (NC)
<b>UNDK 20P6912/S35A</b>	PNP make function (NO)
<b>UNDK 20P7912/S35A</b>	PNP break function (NC)