

Inductive distance measuring sensors

IWRM 12I9705/S14

dimension drawing

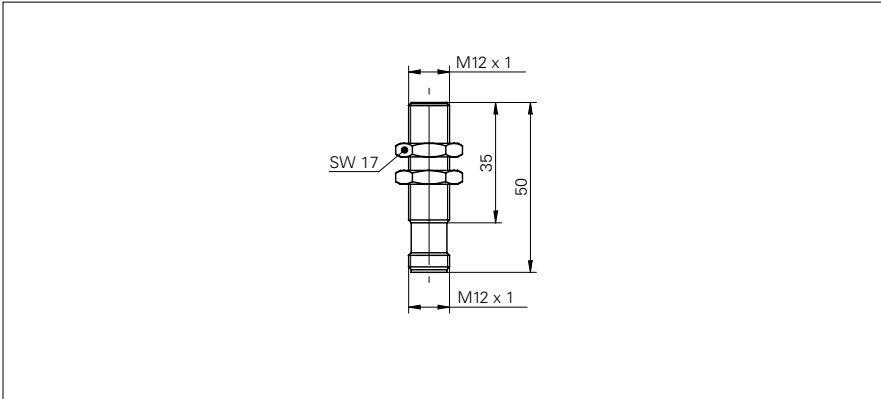

general data

mounting type	quasi-flush
measuring distance Sd	0 ... 4 mm
resolution	< 0,0005 mm (stat.) < 0,001 mm (dynam.)
repeat accuracy	< 0,005 mm
linearity error	± 160 µm
temperature drift	± 4 % (Full Scale)

electrical data

response time (factory characteristic)	< 30 ms
voltage supply range +Vs	15 ... 30 VDC
output circuit	current output
output signal	4 ... 20 mA
load resistance +Vs min.	< 330 Ohm
load resistance +Vs max.	< 1000 Ohm
short circuit protection	yes
reverse polarity protection	yes

mechanical data

type	cylindrical threaded
housing material	brass nickel plated
dimension	12 mm
housing length	50 mm
connection types	connector M12

ambient conditions

operating temperature	-10 ... +70 °C
protection class	IP 67

photo



connection diagram

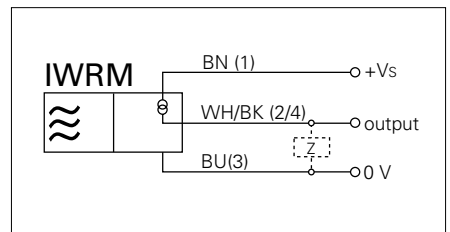

installation drawing

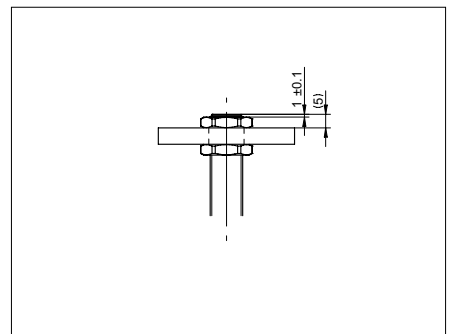

• linearity deviation (S = 0,5...4 mm) ± 4% (Full Scale)