

# Ultrasonic distance measuring sensors

## UNDK 30I6112/S14

### dimension drawing

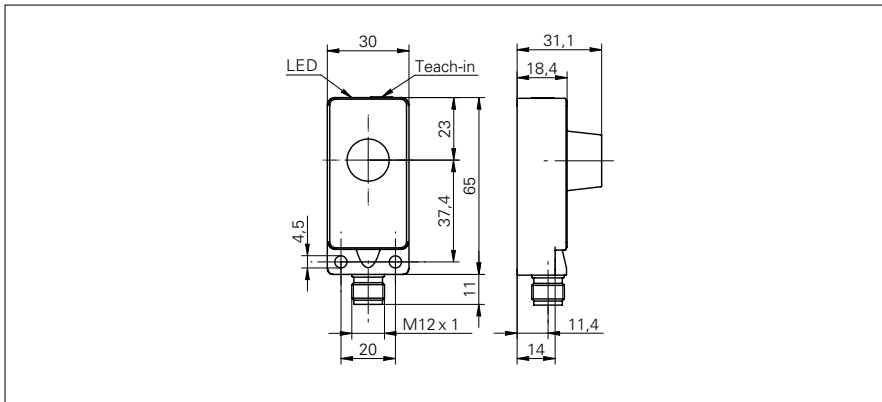

### general data

scanning range Sd	60 ... 400 mm
scanning range close limit Sdc	60 ... 400 mm
scanning range far limit Sde	60 ... 400 mm
repeat accuracy	< 0,5 mm
resolution	< 0,3 mm
response time ton	< 60 ms
release time toff	< 60 ms
temperature drift	< 2 % of distance to target So
sonic frequency	400 kHz
adjustment	Teach-in
alignment aid	target indication flashing
light indicator	yellow LED / red LED

### electrical data

voltage supply range +Vs	15 ... 30 VDC
current consumption max. (no load)	55 mA
output circuit	current output
output signal	4 ... 20 mA / 20 ... 4 mA
output current	< 20 mA
load resistance +Vs max.	< 1100 Ohm
load resistance +Vs min.	< 400 Ohm
residual ripple	< 10 % Vs
short circuit protection	yes
reverse polarity protection	yes

### mechanical data

type	rectangular
housing material	polyester / die-cast zinc
width / diameter	30 mm
height / length	65 mm
depth	31 mm
connection types	connector M12

### ambient conditions

operating temperature	-10 ... +60 °C
protection class	IP 67

### photo



### connection diagram

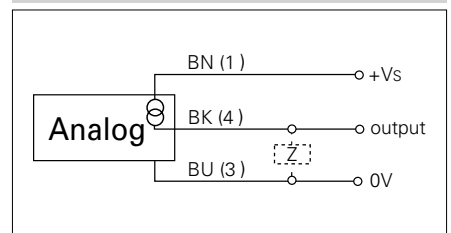

UL.eps

- Analog current output 4-20 mA

# Ultrasonic distance measuring sensors

## UNDK 30I6112/S14

typical sonic cone profile

