

Inductive proximity switch

IFRM 12N33G1/L

dimension drawing

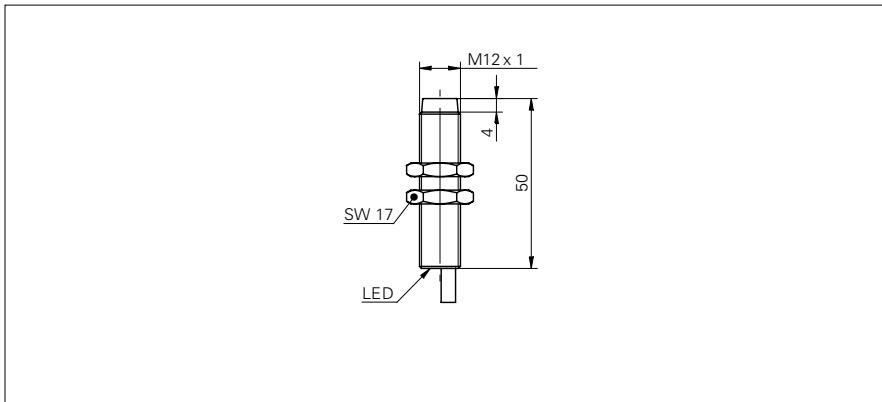

general data

mounting type	non-flush
special type	enhanced distance (GammaProx)
nominal sensing distance S_n	10 mm
hysteresis	2 ... 25 % of S_r
output indicator	LED red

electrical data

switching frequency	< 400 Hz
voltage supply range +Vs	12 ... 30 VDC
current consumption max. (no load)	24 mA
output circuit	NPN break function (NC)
voltage drop V_d	< 2 VDC
output current	< 200 mA
short circuit protection	yes
reverse polarity protection	yes

mechanical data

type	cylindrical threaded
material (sensing face)	PBT
housing material	brass nickel plated
dimension	12 mm
housing length	50 mm
connection types	cable, 2 m

ambient conditions

operating temperature	0 ... +60 °C
protection class	IP 67

photo



connection diagram



- increased sensing distance