

Inductive proximity switch

IFRM 12P17G3/S14L

dimension drawing

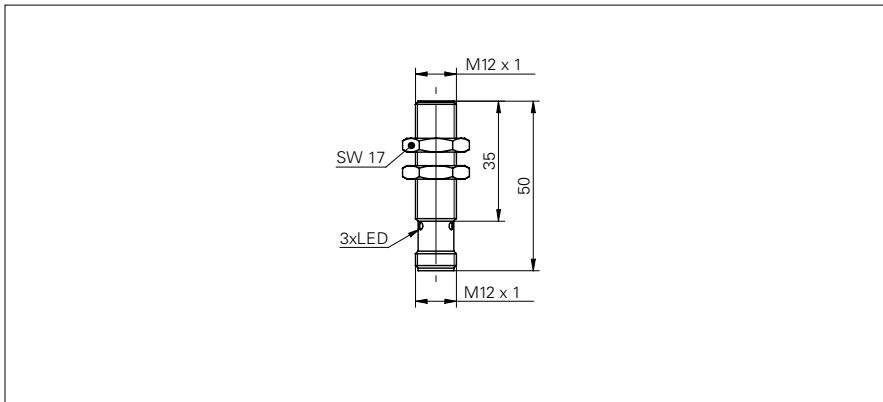

general data

mounting type	quasi-flush
special type	enhanced distance (GammaProx)
nominal sensing distance S_n	6 mm
hysteresis	2 ... 25 % of S_r
output indicator	3 port LED red

electrical data

switching frequency	< 400 Hz
voltage supply range +Vs	12 ... 30 VDC
current consumption max. (no load)	24 mA
output circuit	PNP make function (NO)
voltage drop V_d	< 2 VDC
output current	< 200 mA
short circuit protection	yes
reverse polarity protection	yes

mechanical data

type	cylindrical threaded
material (sensing face)	PBT
housing material	brass nickel plated
dimension	12 mm
housing length	50 mm
connection types	connector M12

ambient conditions

operating temperature	-25 ... +75 °C
protection class	IP 67

photo



connection diagram

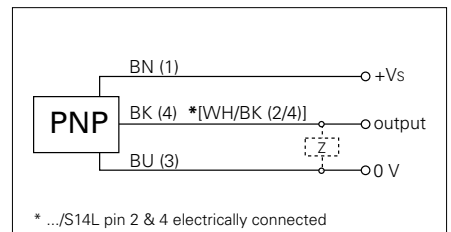

- Not for flush mounting in mild steel
- triple sensing distance
- load resistance: $Z < 100 \text{ k}\Omega$ must be connected