

**Inductive sensors special versions**

**IFRD 08N37A1/S35L**

**dimension drawing**

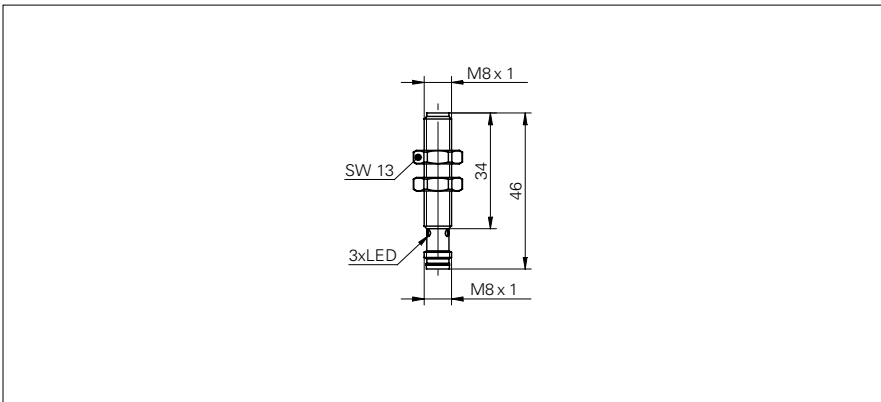

**general data**

mounting type	quasi-flush
special type	full metal housing (DuroProx)
nominal sensing distance $S_n$	2 mm
hysteresis	2 ... 20 % of $S_r$
output indicator	3 port LED red

**electrical data**

switching frequency	< 150 Hz
voltage supply range +Vs	10 ... 30 VDC
current consumption max. (no load)	20 mA
output circuit	NPN break function (NC)
voltage drop $V_d$	< 2 VDC
output current	< 200 mA
short circuit protection	yes
reverse polarity protection	yes

**mechanical data**

type	cylindrical threaded
material (sensing face)	stainless steel 1.4404 (V4A)
housing material	stainless steel 1.4404 (V4A)
pressure static	< 20 bar
dimension	8 mm
housing length	46 mm
connection types	connector M8

**ambient conditions**

operating temperature	-25 ... +75 °C
protection class	IP 68/67 (sensing face/sensor)

**photo**



**connection diagram**

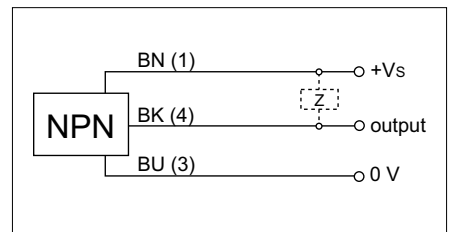

- Higher noise immunity (EMC), (EN 61000-6-2)