

HSD10001

DIN Rail

Made in Germany

1000 Watt Power Supply -25...+70°C

340...575Vac 2 & 3 phase, PFC & active inrush current limiter

Specification:

- Metal housing
- 92% efficiency typ.
- -25°C...+70°C ambient
- Natural convection
- Galvanic insulated
- Continuous short circuit protected
- Overload & low voltage protected
- Soft start & auto-recovery
- Hold up time >12ms
- Minimum load = 0A
- Inrush Current <20Apeak 14,4Aeff (400Vac)
- EMI/EMS EN61000-6-2/3, EN55022 class B
- PFC: EN61000-3-2
- According to cUL60950, IEC(EN)60950-1
- Low voltage & overload control message
- Remote Shutdown ON/OFF
- Power good relay galvanic insulated
- Screw terminals AWG21...AWG6
- High reliability, shock & vibration resistant
- Output Electrolytic Capacitors +125°C
- 2 phase operation 75% rated load

Smart start-up with critical loads:

- motor drives
- capacitive loads
- DC-DC-converters
- Batteries

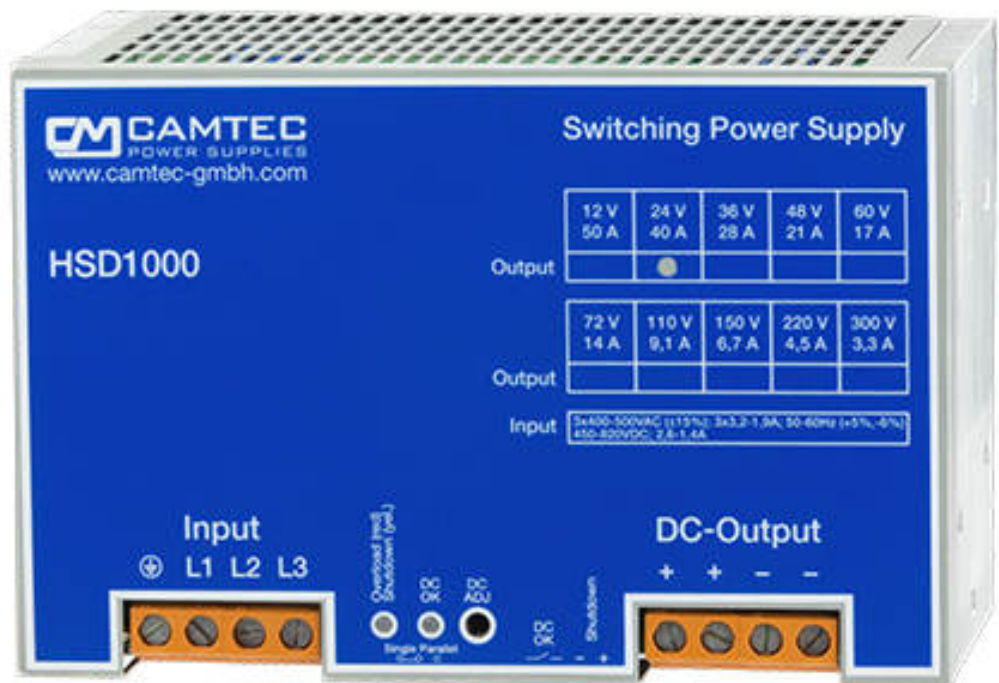

Single-Output: 12V, 24V, 36V, 48V, 60V, 72V



AC Input	2PH & 3PH 340...575Vac , 47...63Hz , 450...820Vdc (2 phase operation 75% rated load max.)					
AC Input Rating	400...500Vac (Input Current 3x 3A)					
DC Voltage Adjust	10...17V (12V)	22...30V (24V)	32...43V (36V)	43...53V (48V)	53...72V (60V)*	68...86V (72V)*
Voltage Protection	21Vdc	32Vdc	50Vdc	56Vdc	84Vdc	92Vdc
Current 60°C*	50.0A (12Vdc)	40.0A (24Vdc)	28.0A (36Vdc)	21.0A (48Vdc)	17.0A (60Vdc)	14.0A (72Vdc)
DC Current 40°C*	55.0A (12Vdc)	44.0A (24Vdc)	30.8A (36Vdc)	23.1A (48Vdc)	18.7A (60Vdc)	15.4A (72Vdc)
Boost 60s/60°C*	55.0A (12Vdc)	44.0A (24Vdc)	30.8A (36Vdc)	23.1A (48Vdc)	18.7A (60Vdc)	15.4A (72Vdc)
Ripple 20MHz	50mVpp	50 mVpp	80 mVpp	100 mVpp	100 mVpp	150 mVpp
Load regulation.*	±0.5% (12Vdc)	±0.2% (24Vdc)	±0.2% (36Vdc)	±0.2% (48Vdc)	±0.2% (60Vdc)	±0.2% (72Vdc)
0-100% 100-0%						
*400Vac input >60Vdc !	*Power Good Relay & Shutdown: no protective electrical separation					

Tolerance (at Ua adjusted)	± 0.5%
Transient Time	<1ms (10-100% , 100-10%)
Minimum Load	0 A
Efficiency	92% typical
Load Protection	1,2x I _{rated} , auto recovery
Short Circuit Protection	Yes
Temperature Control	Yes (see right graph)
Hold Up Time	> 12ms (400...500Vac input)
Inrush Current Limiter	< 20Apeak 14,4Aeff (400Vac)
Softstart	50ms typical
Cooling	Natural convection
Ambient Temperature	- 25°C...+70°C
Storage Temperature	- 40°C...+85°C
EMI	EN55022 class B / EN61000-3-2
EMS	EN61000-6-2,3 active PFC
Safety	EN60950-1, EN60204-1
Safety class 1(A)	VDE0805, VDE0100
Creepage Distance	> 10,5mm
Input/output	Galvanic insulated 3000Vac
Power Good Relay (galv.ins.)	≤48Vdc/500mA , ≤30Vac/500mA
Relative Humidity	95% (25°C) non-condensing
Pollution Degree	2 (EN50178)
Climatic Class	3k3 (EN60721)
MTBF IEC61709	500000h (IEC61709)
MTTF IEC60050	147.524h (40°C/230Vac/75%)
Dimensions (HxWxD)	131.5x200x124.5mm
Weight	3400g
Connectors (AC & DC)	AWG22...AWG6 (0,5...16mm ²)
(see page 4)	IEC60664-1, IEC61984

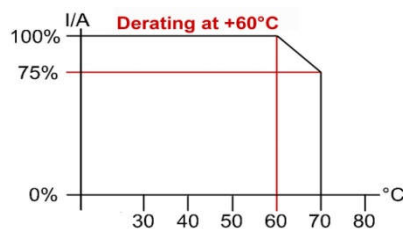

For further derating information see table 3

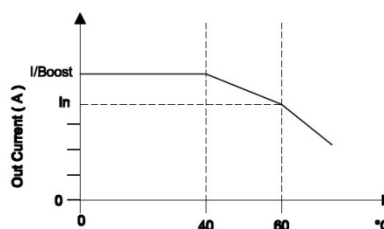

Temperature Control:

If the ambient temperature (t_a) $\leq 40^\circ\text{C}$ the HSD provides I/Boost continuously and if $t_a \leq 60^\circ\text{C}$ I_{rated} is provided continuously. If $t_a > 60^\circ\text{C}$ derating continuously lowers V_{out} 2,5%/Kelvin. If $t_a > 70^\circ\text{C}$ (or thermal overload occurs) the HSD shuts down. It auto-recovers when the device cools down to approved operation conditions.

All parameters are specified at +25°C, 5 minutes run in time if not named otherwise.

Specification:

The HSD10001 DIN Rail power supply series is designed for worldwide electronics applications like machine building, railway, military and factory automation. Its regulated DC output with ripple/noise lower than 50mVpp and its high efficiency of 92% makes the HSD robust, economical and reliable. Camtec power supplies are traditionally made with high end low ESR electrolytic output capacitors withstanding +125°C temperature. Our capacitors are rather designed over for longer lifetime and longer hold up times. The power-boost of the HSD starts DC-loads and DC-motors reliable. The built in function diagnostics detects malfunctions. The galvanic insulated DC fail relay and remote on/off provides full control over the power supply unit. The HSD is short circuit and zero load stability protected. It is protected against high transient and provides very good interference resistance. Equal types of the HSD10001 can be operated in parallel or in series connection (we highly recommend to consult our support for safety instructions!). We use IP20 stabile aluminum housings with ventilation slots in accordance to the demanding VDE norms. The design meets EN(IEC)60950-1 and low voltage directive EN55022 Class B.

Block Diagram

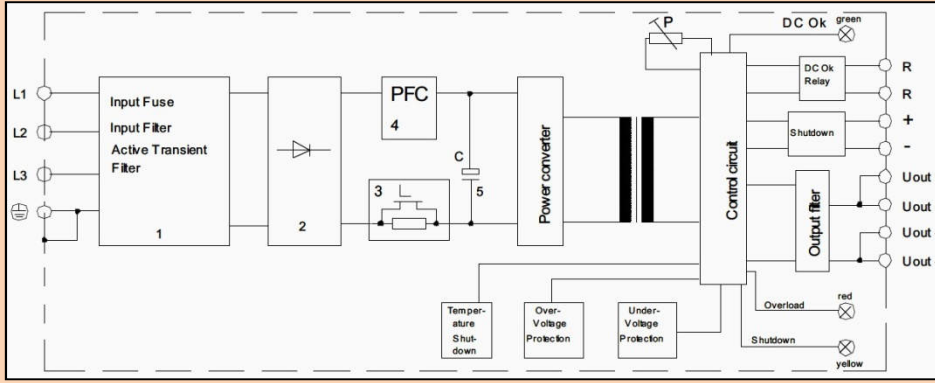

- 1) Transient Suppressor (VDR) & Filters, Input Fuses
 - 2) Rectifier
 - 3) Electronic Inrush Current Limiter
 - 4) PFC
 - 5) Load Capacitor C
 - 6) Potentiometer (P)
- Complex sane filter technology using varistors, suppression diodes and X2 capacitors, apply major transient resistance to the input filter.
- Overload:** If $<0.9 \times V_{out}$ applies to the outputs, the red LED lights and the DC-OK-Relay (Re) drops (control message). The green DC-OK LED is off.

Remote Shutdown

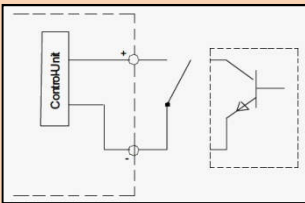

Enable a 18...30Vdc 20mA voltage signal (Rmt/Rm) to shutdown the HSD, the yellow LED lights and 0V is distributed to the outputs. If the shutdown is short circuited or $<500mV$ are applied to (Rmt/Rm), the HSD „tickers“, the yellow LED flashes and $U_{out} < 5V$ is distributed to the outputs. Disable the remote voltage to restart the HSD

Power Good Control

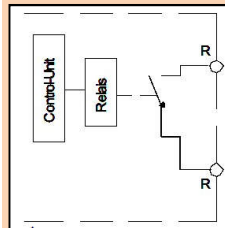

Low Voltage:
If adjusted V_{out} drops 10% the red LED lights and the DC-OK-Relay (Re) drops (control message). The green DC-OK LED is off.

Overload: If $<0.9 \times V_{out}$ applies to the outputs, the red LED lights and the DC-OK-Relay (Re) drops (control message). The green DC-OK LED is off.

V_{out} o.k. = relay closed
 V_{out} fail = relay open

Series Connection

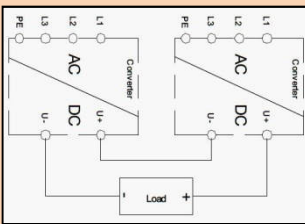

To increase the output power, equal HSD devices can be used series connected. Observe to safety directives when the output voltage achieves 60Vdc in sum.

Redundant Connection

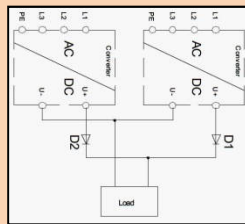

To increase system availability up to five HSD can be used in parallel operation mode. Please make sure that wiring length from all units to the load is equal. Full redundant operation modes require external diodes. We suggest to use our RED00202 DIN-Rail N+1 redundant module für professional redundancy.

Inrush Current Limitation (Block Diagram)

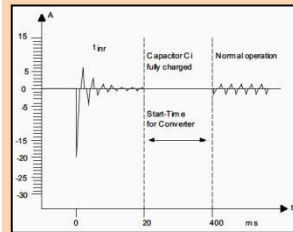
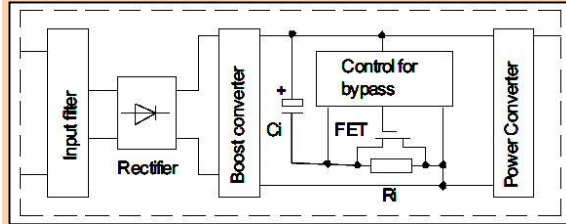

While connecting the HSD to the AC wire network its inrush current is limited to $<20A_{peak}/14.4A_{effective}$. The start capacitors are loaded after 20ms and the HSD actuates. After passing softstart the power supply is ready for operation after a total of $\Delta t=400ms$.

Characteristics $V_i=400Vac$:
Peak Inrush Current = $<14.4A_{eff}$.
Peak Limiting Duration = 20ms

Power Boost and Temperature Behaviour

The HSD10001 operates in accordance to the V/C-characteristic line (see graph I/Boost on page 2). It has a determinate power reserve (boost): With ambient temperatures $\leq 40^\circ C$ the power boost is continuously available while with higher ambient temperatures it is available for a few minutes. When a DC short circuit or an overload occurs to the HSD10001, it is limited to I/Boost (see graph) but it is not shot down. The DC-voltage is lowered until the error is rectified. The V/C-line and the power boost apply operation of critical loads, like DC-DC-converters, capacitive loads, drives and batteries trustworthy.

Output voltage/current ratio to ambient (U/I to $^\circ C$)

U_{out}	$40^\circ C/I_{out}$	$60^\circ C/I_{out}$	U_{out}	$40^\circ C/I_{out}$	$60^\circ C/I_{out}$
10Vdc	55,0A	50,0A	36Vdc	30,8A	28,0A
12Vdc	55,0A	50,0A	40Vdc	27,7A	25,2A
15Vdc	55,0A	50,0A	46Vdc	24,0A	21,9A
22Vdc	48,0A	43,6A	48Vdc	23,1A	21,0A
24Vdc	44,0A	40,0A	53Vdc	20,6A	18,7A
26Vdc	40,6A	36,9A	60Vdc	18,7A	17,0A
28Vdc	37,7A	34,3A	65Vdc	17,3A	15,7A
30Vdc	36,2A	32,0A	72Vdc	15,8A	14,2A
32Vdc	33,0A	30,0A	86Vdc	12,9A	11,7A
34Vdc	32,6A	29,6A			

Test	Time	A	B	C	D
Type Test	60s	2500Vac	3000Vac	500Vdc	500Vdc
Factory Test	5s	2000Vac	2000Vac	500Vdc	500Vdc
Field Test	2s	2000Vac	2000Vac	500Vdc	500Vdc

Type test and factory tests are conducted by the manufacturer. Do not repeat the test in field. Field test rules:

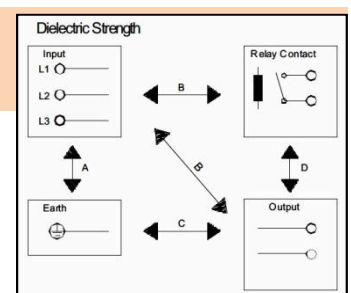

- Use appropriate test equipment which apply the voltage with a slow ramp
- Connect L1,L2 and L3 together, as well as all output poles
- Use only AC test-voltages with 50/60Hz. The output voltages is floating and has no ohmic reference to ground.
- If testing output voltages are $\geq 60\text{Vdc}$ remain to security directives. Use only isolated screw drivers to adjust output voltages.

Function Table and Messages

Indicators	DC-ok LED green	Overload LED red	Shutdown LED yellow	DC-ok Relay
Normal operation	On	Off	Off	Closed
Power boost	On	Off	Off	Closed
Overload (0.9xVout)	Off	On	Off	Open
Shutdown with open contact	On	Off	Off	Closed
Shutdown with 10...30Vdc	Off	Off	On	Open
Shutdown with <math>< 500\text{mVdc}</math>	Off	Pulse	Pulse	Open
Temperature shutdown	Off	Off	Off	Open
Input voltage low or fail	Off	Off	Off	Open

Terminal Connects:

Input	GND	Output	DC +	Control & monitoring connections:	Screw terminal order codes:
L1		DC +		A= parallel/series mode switcher	DC-fail-relay& Shutdown, one plug for each required
L2		DC -		B= DC-OK Relay	(each package = 10 pcs)
L3		DC -		C= Remote On/Off (shutdown)	Art.No.: 3520037 (2 pins)

Optional Coating (option C):

We offer the HSD-Series with optional coating. It is to be used in e.g. dusty, dirty, high humidity, or in awaiting quick temperature changes. Short circuit and corrosion at print board lines and at solder points can be prevented. The coat itself is a transparent acrylic resin. It is procured with a robotics varnishing machine.

Peters SL 1306 N-FLZ (transparent) IEC60216-1 2001, IPC-CC-830B, UL listed as permanent coating FileNo.: E80315 , UL94V-0

Order Codes:

HSD10001.12T 10..17Vdc DIN-Rail HSD10001.48T 43..53Vdc DIN-Rail
HSD10001.24T 22..30Vdc DIN-Rail HSD10001.60T 53..72Vdc DIN-Rail
HSD10001.36T 32..43Vdc DIN-Rail HSD10001.72T 68..86Vdc DIN-Rail

Options to be added to the order-code:

C=coating exs: HSD10001.24TC DIN-Rail+Coating

Mechanics & Installation of the HSD10001:

Stable metal/aluminium housing IP20. To allow adequate convection, a free air space of 50mm (top/bottom) and 5mm (sidewalls) is required for the HSD10001; for active devices 15mm space from the HSD-sidewalls. For free air convection it is necessary to install the HSD horizontal (**Figure 1**). You can use the DIN-Rail installation (equiped standard) with our patented 35mm DIN-Rail bracket according to EN60275. It is easy to mount/dismount while snapping it onto the 35mm DIN-Rail without any tools necessary. It is a wallmount fastener available as option, too. Use the wall mount option for baseplate-cooling. Consult our support for further information.

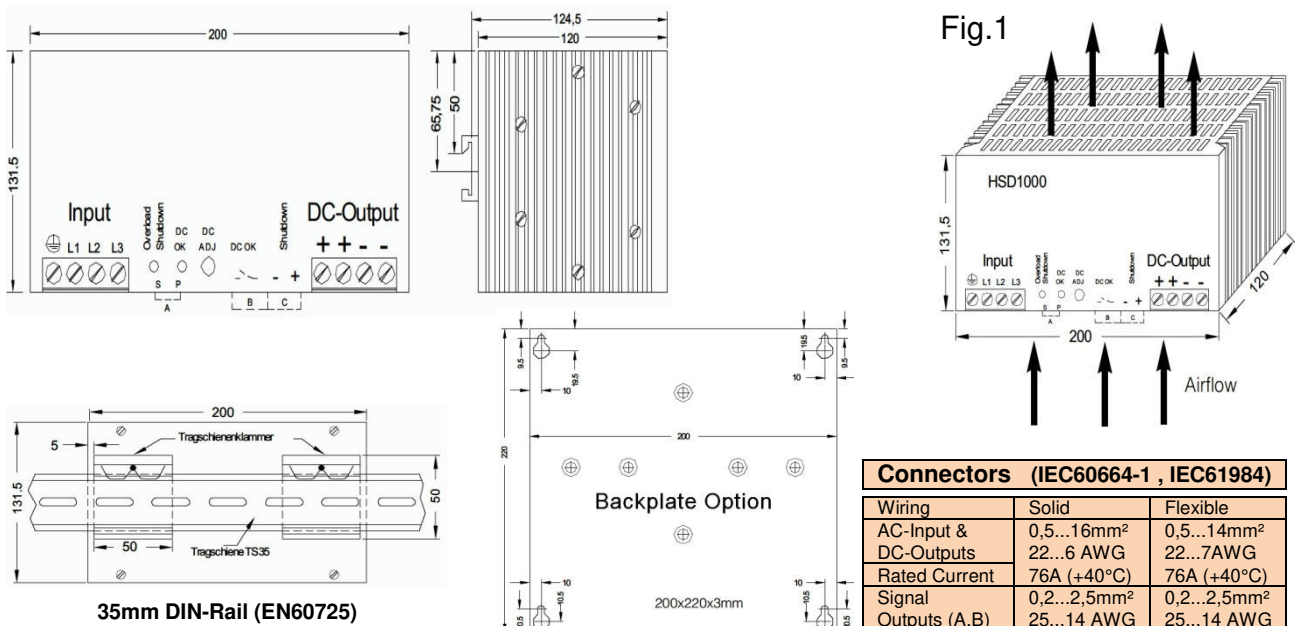

Connectors (IEC60664-1, IEC61984)

Wiring	Solid	Flexible
AC-Input & DC-Outputs	0,5...16mm ² 22...6 AWG	0,5...14mm ² 22...7AWG
Rated Current	76A (+40°C)	76A (+40°C)
Signal Outputs (A,B)	0,2...2,5mm ² 25...14 AWG	0,2...2,5mm ² 25...14 AWG

Safety Instructions: Please read all warnings and advices carefully before installing or operating the HSD. Retain this operation manual always ready to hand. The HSD must be installed by specialist staff only.

Installation:

- 1.) The HSD is designed for systems fulfilling the safety norms of dangerous voltages/energy and fire prevention
- 2.) Installation is restricted to specialists only, make sure that the AC wire system is free of voltage
- 3.) Opening the HSD, making any modifications to it, dismantling any screws from it, operating the HSD out of specification and/or using it in appropriate area will inevitably result in losing manufactureres guarantee; we decline taking any responsibility for risk of damages caused to someones health or to any installed system.
- 4.) Attention: The HSD has an internal input fuse. It is necessary to wire an automatic circuit breaker to the line. We suggest to use a 10A-type with B-characteristic. It is verboten to operate the HSD without protective earth wired. It essential to install a line switch before the HSD.

Warnings:

Disregard these warnings can cause fire, electric shock, serious accident and death.

1. **Never operate the HSD without Protective Earth Conductor**
2. **Before connecting the HSD to the AC wire system make all wires free of voltage and assure accidently switch on**
3. **Allow neat and professional cabling**
4. **Never open nor try to repair the HSD by yourself. Inside are dangerous voltages that can cause electric shock hazard.**
5. **Avoid metal pieces or other conductive material to fall into the HSD**
6. **Do not operate the HSD under damp or wet conditions**
7. **It is verboten to operate the HSD under Ex  conditions or in Ex-Area**

All parameters base on 5 minutes run-in @ full load / 25°C / 230Vac 50/60Hz, as otherwise stated.