

GENERAL DESCRIPTION



- MULTIDRIVE is a Full digital and universal Thyristor unit based on a very powerful dedicated micro configurable via serial communication port for all inputs, firing modes, control modes and loads types.
- Suitable to drive resistive, inductive, transformer and complex loads requiring current limit and power control mode.
- Frontal Key Pad standard to configure all the internal functions and parameters.
- Four Analog output configurable
- Six Digital input
- Four relay output
- Universal Input signal with automatic zero/span calibration.
- Universal Firing modes, customer configurable via Key Pad or communication port as Burst Firing and Phase Angle.
- Universal Feed back modes
- Soft Start can be used in addition to Burst Firing and Phase Angle.
- Unbalanced load and Heater Break Alarm.
- RS 485 port. Modbus protocol
- Comply with EMC and *
- IP20 Protection

TECHNICAL SPECIFICATION

Operating Temperature	0+40°C over this temperature see derating curve
Voltage Power supply	480V standard, 600V or 690V on request
Auxiliary Voltage Supply	90÷265V, 20VA power consumption. Fan voltage supply: 230V ±15% as a standard and 110V on request.
Analog Input 1	Main reference, 4÷20mA, 0÷10V, 10KPOT, RS485 port
Analog Input 2	Secondary reference, 0÷10V, 10KPot
Analog Input 3	External Current Limit Set, via analog input 0-10V or KPOT
Analog Output	Four Analog output (0÷20mA or 4÷20mA) for retransmitted of, Voltage or Power and current for each Phase
Digital Input	Six optoisolated digital input (12/24Vdc), for START, STOP, ENABLE, CALIBRATION, RESET ALARM and EXTERNAL ALARM
Relay Output	Three configurable relay output and one critical alarm
Universal Firing	One of these firing modes can be configured Burst Firing BF, Single Cycles SC, Soft Start + Burst Firing S+BF; Soft Start + Phase Angle S+PA; Delayed Triggering DT
Soft Start	Digital adjustable ramp rate
Control Mode	Voltage (V), Current (I), Power (VxI) and External feedback
Heater Break Alarm	Circuit microprocessor based to diagnose partial or total load failure and short circuit on Thyristors
Unbalanced load	This protection allow to have Multidrive working up to 20% of unbalance on one phase
Communication	RS485 Port. Modbus communication protocol 9600 or 19200 bauds
Thermal protection	Available on forced ventilated units

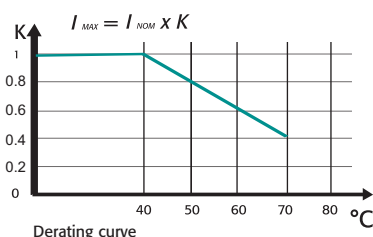

* cUL approval up to 500A included

HEATER BREAK ALARM HB

ON FRONT CABINET



= FEW MINUTES TO SET AND CALIBRATE ALL THE UNITS

The Heater Break circuit diagnostic partial or total load failure. It reads load resistance with an internal voltage transducer and current transformer to calculate the resistance value V/I .

The Heater Break circuit is compensated for voltage fluctuation, in fact a voltage variation has no influence on resistance value because V/I ratio remain constant.

On this unit is possible to set the nominal resistance value and the alarm sensitivity.

HB alarm in addition diagnostic the thyristor in short circuit.

A normally open contact gives the alarm condition and an indication of the alarm type appears on display.

BURST FIRING BF

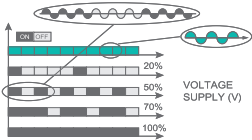

This firing is performed digitally within the thyristor unit at zero volts, producing no EMC interference. Analogue input is necessary for BF and the number of complete cycles must be specified for 50% power demand. This value can be between 1 and 255 complete cycles, determining the speed of firing. When 1 is specified, the firing mode becomes Single Cycle (SC).

PHASE ANGLE PA

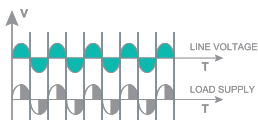

PA controls the power to the load by allowing the thyristor to conduct for part of the AC supply cycle only. The more power required, the more the conduction angle is advanced until virtually the whole cycle is conducting for 100% power. The load power can be adjusted from 0 to 100% as a function of the analogue input signal, normally determined by a temperature controller or potentiometer, PA is normally used with inductive loads.

DELAYED TRIGGERING DT

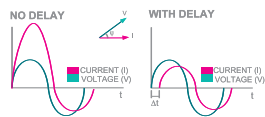

Used to switch the primary coil of transformers when coupled with normal resistive loads (not cold resistance) on the secondary, DT prevents the inrush current when zero voltage (ON-OFF) is used to switch the primary. The thyristor unit switches OFF when the load voltage is negative and switches ON only when positive with a pre-set delay for the first half cycle.

CD EASY



This is a memory support tool that can be used by maintenance personnel on shop floor.

The user can copy the configuration of one unit and paste it into another. CD EASY is very simple with one push button to upload the configuration (Read) and another to download the stored configuration (Write)

This tool can be used with our Remote service to mail the working configuration via internet.

CD-KP



The CD-KP is designed mounted on front cabinet and to be connected with all cd automation's Thyristor units via RS485. On front unit is possible to read parameters, power, current, reference and alarms. One of these variables can be selected and retransmitted via an isolated output (4-20mA or 0-10V) On front unit is available a connector to communicate with PC. In addition are available Local/Remote, up and down and function command.

FIELD BUS MODULE



CD-RS Used to convert RS232 to RS422

TU-RS485-PDP Used to convert RS485 Modbus to Profibus DP

TU-RS485-ETH Used to convert RS485 Modbus to Ethernet

For more informations see "Field Bus Module" Bulletin

POWER SCALING

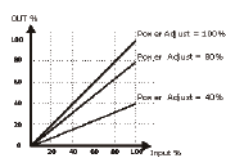

It's a scaling factor of the input command signal and limit the output of Thyristor unit. This parameter can be adjusted from 1 to 99% via RS485 or by the front of the unit. If this parameter is set at 50% and the input signal is 100% the output become 50%. This feature is very useful to reduce the power when a zone has been oversized or when a temperature controller gives same reference to more unit along a furnace.

Imagine 3 zones with left and right one close to the door where in a continuous furnace the material come into and flow out. The profile of temperature along furnace is higher in central zone because there is less dispersion but if we scale its input we can have a flat profile.

APPLICATIONS AND FOCUS ON:

- Infrared lamp.
- Autoclaves.
- Furnaces.
- Chemical
- Petrochemical
- Climatic chambers
- Pharmaceutical

WIRING CONNECTION MULTIDRIVE 3PH from 35A to 2700A

MULTIDRIVE 3PH

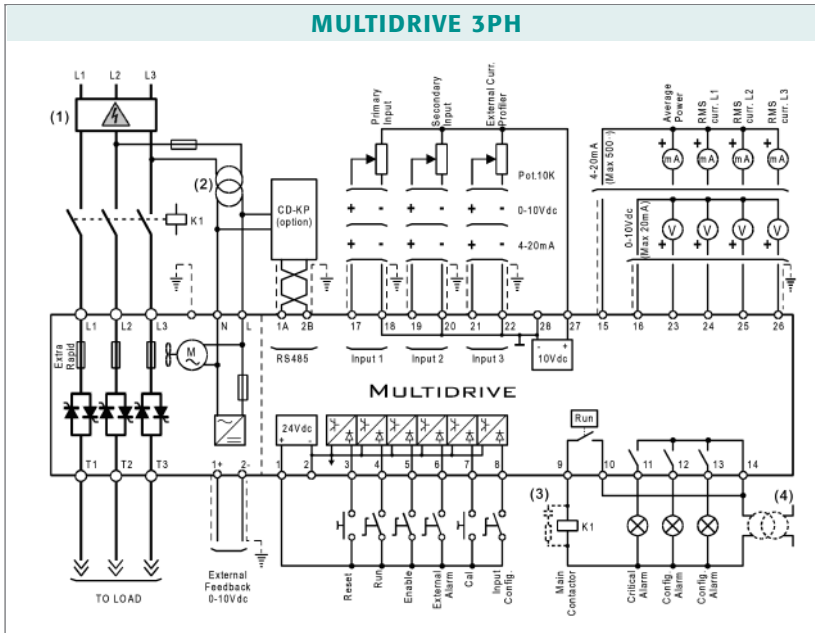

NOTE

- The user must provide for protection external electro-magnetic circuit breaker or fuse isolator.
- Use an appropriate external transformer to supply of the electronic board (see the identification label)
- The coil contactor, the relays and other inductive loads must be equipped with opportune RC filter.
- Before give the Start command supply the input of auxiliary voltage



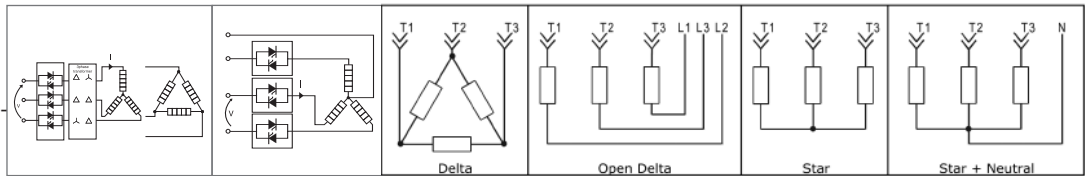

LOAD TYPE

Three phase transformer

Cold Resistance
Molibdenum, Tungstenum
KantalSuper Platinum,
Quartz lamp infrared short wave-
form
Silicon carbide elements

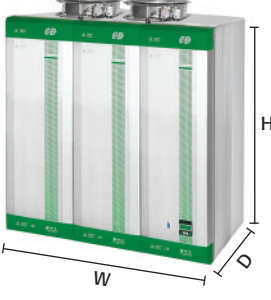

DIMENSION AND FIXING HOLES

 <p>S13 W 262 mm. - H 440 mm. - D 270 mm. - kg. 18 25A ÷ 225A</p>	 <p>S14 W 262 mm. - H 520 mm. - D 270 mm. - kg. 22,5 300A ÷ 600A</p>	 <p>S15 W 400 mm. - H 520 mm. - D 270 mm. - kg. 43 850A</p>
 <p>S22 W 525 mm. - H 580 mm. - D 435 mm. - kg. 56 1000A</p> <p>S25 W 525 mm. - H 780 mm. - D 435 mm. - kg. 77 1400A</p> <p>S25 W 525 mm. - H 780 mm. - D 435 mm. - kg. 77 1500A</p>	 <p>S26 W 780 mm. - H 790 mm. - D 533 mm. - kg. 144 1850A</p> <p>S26 W 780 mm. - H 790 mm. - D 533 mm. - kg. 144 2000A</p> <p>S27 W 890 mm. - H 790 mm. - D 518 mm. - kg. 174 2400A</p> <p>S27 W 890 mm. - H 790 mm. - D 518 mm. - kg. 174 2700A</p>	

OUTPUT FEATURES (POWER DEVICE)

Current A	Voltage range (V)	Ripetitive peak reverse voltage (600V) (690V)		Latching current (mAeff)	Max peak one cycle (10msec.)	Leakage current (mAeff)	I2T value for fusing tp=10msec.	Frequency range (Hz)	Power loss I=Inom (W)	Isolation Voltage Vac
35A	330÷690V	1600	1800	450	1000	15	4750	47÷70	126	2500
45A	330÷690V	1600	1800	450	1000	15	4810	47÷70	162	2500
75A	330÷690V	1600	1800	450	1000	15	4810	47÷70	270	2500
100A	330÷690V	1600	1800	450	1540	15	11300	47÷70	360	2500
125A	330÷690V	1600	1800	450	2000	15	19100	47÷70	450	2500
150A	330÷690V	1600	1800	450	2000	15	19100	47÷70	540	2500
255A	330÷690V	1600	1800	300	4800	15	108000	47÷70	810	2500
300A	330÷690V	1600	1800	300	5250	15	128000	47÷70	1080	2500
350A	330÷690V	1600	1800	200	7800	15	300000	47÷70	1260	2500
400A	330÷690V	1600	1800	200	8000	15	306000	47÷70	1440	2500
450A	330÷690V	1600	1800	1000	17800	15	1027000	47÷70	1620	2500
500A	330÷690V	1600	1800	1000	17800	15	1027000	47÷70	1800	2500
600A	330÷690V	1600	1800	1000	17800	15	1027000	47÷70	2160	2500
850A	330÷690V	1600	1800	1000	17800	15	1027000	47÷70	3000	2500
1000A	330÷600V	1600	N.A.	700	12500	300	781000	47÷70	3300	2500
1400A	330÷690V	1600	1800	700	24600	300	3026x1E3	47÷70	4620	1700
1500A	330÷600V	1600	N.A.	700	24600	300	3026x1E3	47÷70	5625	1700
1850A	330÷690V	1600	1800	700	36000	300	6480x1E3	47÷70	6105	2500
2000A	330÷600V	1800	N.A.	700	36000	300	6480x1E3	47÷70	6600	2500
2400A	330÷690V	1800	1800	700	60000	300	180000x1E3	47÷70	8000	2500
2700A	330÷600V	2200	N.A.	700	60000	300	180000x1E3	47÷70	10125	2500

ORDERING CODES MULTIDRIVE 3PH

Note 1

		1	2	3	4	5	6	7	8	9	10	11	12	13	14	15	16
MULTIDRIVE 3PH		M	3	-	-	-	-	-	-	-	-	-	-	-	-	-	-
4, 5, 6 Current		7 Max Voltage		10 Firing		14 Approvals											
Description code	Numeric code	Description code	Numeric code	Description code	Numeric code	Description code	Numeric code										
35A	0 0 3 5	480V	4	Zero Crossing ZC	Z	CE EMC For European Market	0										
45A	0 0 4 5	600V	6	Single Cycle SC	C	cUL For American Market up to 500A included	L (4)										
75A	0 0 7 5	690V	7	Burst Firing BF	B	15 Manual											
100A	0 1 0 0	8 Aux. Voltage supply		Soft Start + Burst Firing S+BF	J	Description code	Numeric code										
125A	0 1 2 5	Description code	Numeric code	Delayed Triggering + Burst Firing DT+BF	D	None	0										
150A	0 1 5 0	110V	1	Phase Angle PA	P	Italian Manual	1										
225A	0 2 2 5	230V	2	Soft Start + Phase Angle S+PA	E	English Manual	2										
300A	0 3 0 0	9 Input		11 Control Mode		German Manual	3										
350A	0 3 5 0	Description code	Numeric code	Description code	Numeric code	French Manual	4										
400A	0 4 0 0	SSR 3:30V dc	S	Open Loop	0	16 Load type/Connection											
450A	0 4 5 0	0:10V	V	Voltage Feed Back V	U	Description code	Numeric code										
500A	0 5 0 0	4:20mA	A	Power Feed Back Vxl	W	Resistive Load/Delta Connection	1										
600A	0 6 0 0	10KPot	K	Current Feed Back I	I	Resistive Load/Star Connection	2										
850A	0 8 5 0	RS485	R	External Feed Back	E	Resistive Load/Star Connection + Neutral	7										
1000A	1 0 0 0 (2)	12 Option (3)		13 Fan Voltage		Transformer Load/Delta Connection	3										
1400A	1 4 0 0	Description code	Numeric code	Description code	Numeric code	Transformer Load/Star Connection	4										
1500A	1 5 0 0 (2)	4:20mA Retransmission	A	Fan Voltage equal to Aux. Voltage	3	Transformer Load/Star Connection + Neutral	5										
1850A	1 8 5 0	0:10V Retransmission	V			Resistive Load/Open delta	6										
2000A	2 0 0 0 (2)																
2400A	2 4 0 0																
2700A	2 7 0 0 (2)																

LEGEND

IF = Internal Fixed Fuse
 CT = Current Transformer
 HB = Heater Break Alarm

Note (1): After 16th digit write current and voltage of load inside brackets Ex. (190A-400V), this is to receive the Thyristor unit already tuned from CD Automation

Note (2): Rating not available at 690V

Note (3): In total are available 4 Analog output . One dedicated to control mode and the other 3 for current on phases 1-2-3

Note (4): cUL approval up to 500A included

