

### Main features

- Sensor and connection in stainless steel, AISI 316L
- DIN form B housing
- Robust design

### Applications

- Industrial applications with industrial process connection
- Pipe systems
- Heating systems
- Water systems
- Tanks and vessels
- Railway



**EN 50155**

### Technical specification

Housing	DIN form B, Aluminium
El. connection	M20 or M16
Output	Pt100/Pt1000 resistance signal Ceramic terminal block. 4...20 mA, 20...4 mA, HART temperature transmitter
Sensor tube material	Stainless steel 1.4404 (AISI 316L)
Sensor diameter outside	Ø 6, Ø 8 or Ø 10 mm
Sensor length	Standard tip <3000 mm Fast response tip <300 mm
Standard response tip	As outside sensor diameter
Fast response tip	Ø 4 x 20 mm
Max. flow velocity	Air : 40 m/sec Liquid : 5m/sec.

### Sensor element, Pt100 - DIN/EN/IEC 60751

Pt100 DIN class B	$\pm (0.3 + 0.005xt) \text{ } ^\circ\text{C}$
Pt100 1/3 DIN class B	$\pm 1/3 \times (0.3 + 0.005xt) \text{ } ^\circ\text{C}$
Pt100 1/6 DIN class B	$\pm 1/6 \times (0.3 + 0.005xt) \text{ } ^\circ\text{C}$
Pt100 DIN class A	$\pm (0.15 + 0.002xt) \text{ } ^\circ\text{C}$
Single element	1 x Pt100
Double element	2 x Pt100
Connection	2-wire or 4-wire

### Sensor element, Pt1000 - DIN/EN/IEC 60751

Pt1000 DIN 1/3 DIN class B	$\pm 1/3 \times (0.3 + 0.005xt) \text{ } ^\circ\text{C}$
Single element	1 x Pt1000
Connection	2-wire

### Environment

Ambient temperature	w.terminal block	-40...160 °C
	w. transmitter	-40...85 °C
Process temperature		-50...400 °C, option: <600 °C
Protection class		IP65
Humidity		<100% RH, condensing
Vibrations		GL, test 2

### Pressure

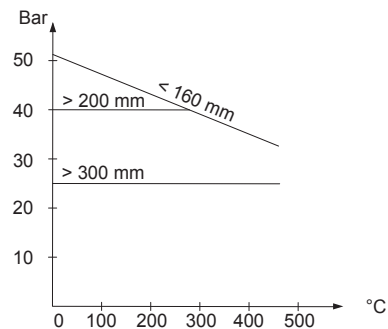

### Response time

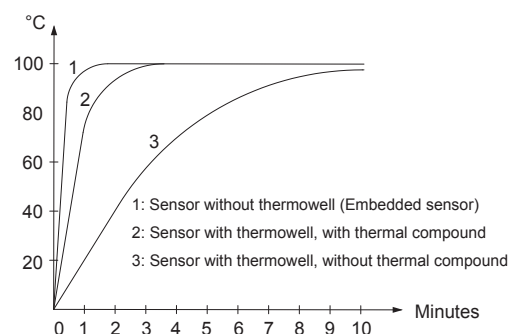

Note: When a pocket is used, the time delay increases. The delay is the time duration for the sensor to reflect the correct temperature after a sudden temperature change in the media.

**Dimensions (mm), connection diagram and construction details**

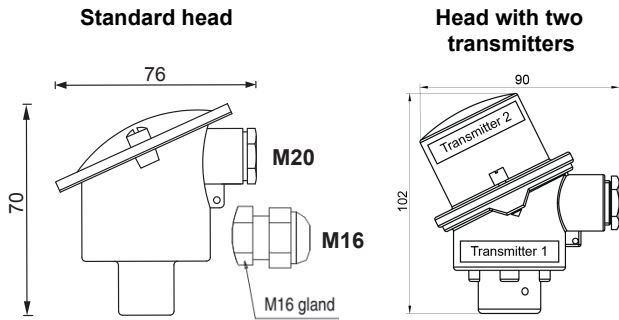

**Embedded sensor**

Not with replaceable sensor

Faster response time see page 1

**Cable sensor insert**

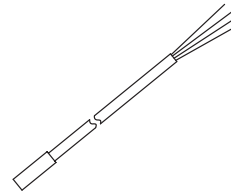

**Insert acc. to DIN 43762**

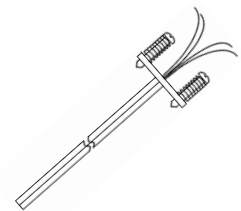

**Ceramic terminal block**

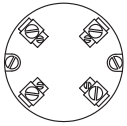

**Temperature transmitter**

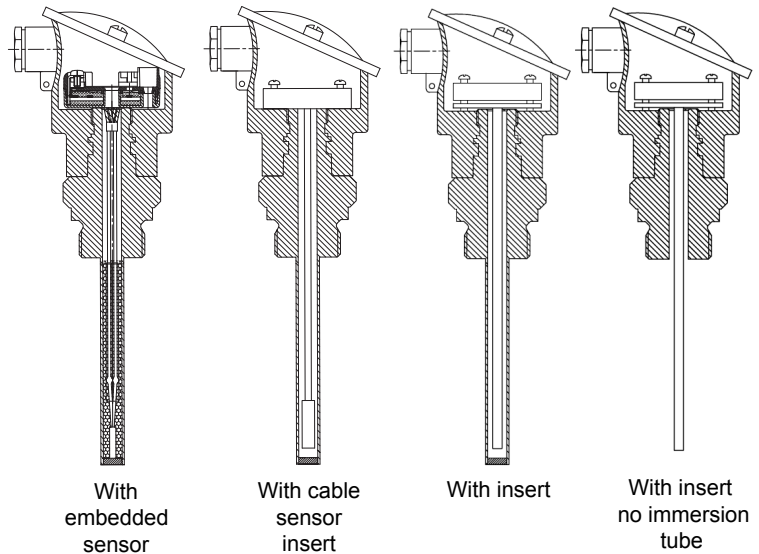
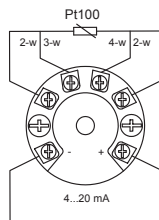
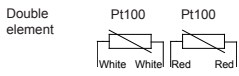
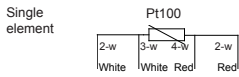

**Transmitter, type FlexTop 2202 - Standard**

Input	Pt100
Output	4...20 mA
Accuracy	
Input	< ±0.25°C
Output	< ±0.1% signal span (16mA)
Range	-200...850°C
Minimum span	25°C
Supply	8...35 VDC
Programmability	By FlexProgrammer 9701
For further information please see data sheet for FlexTop 2202	

**Transmitter, type FlexTop 2211 - Performance**

Input	Pt100 / Pt1000 (universal)
Output	4...20 mA
Accuracy	
Input	< ±0.1°C
Output	< ±0.1% signal span (16mA)
Range	-200...850°C
Minimum span	25°C
Supply	8...35 VDC
Programmability	By FlexProgrammer 9701
For further information please see data sheet for FlexTop 2211	

**Transmitter, type FlexTop 2221 - Performance**

Input	Pt100 / Pt1000 (universal)
Output	4...20 mA / HART
Accuracy	
Input	< ±0.1°C
Output	< ±0.1% signal span (16mA)
Range	-200...850°C
Minimum span	25°C
Supply	8...35 VDC
Programmability	By FlexProgrammer 9701 By HART terminal/modem
For further information please see data sheet for FlexTop 2221	

**Transmitter, type FlexTop 2212 - Performance**

Input	Pt100 / Pt1000 (universal)
Output	4...20 mA / 20...4 mA
Accuracy	
Input	≤ ±0.06°C
Output	< ±0.025% of output span (16mA)
Range	-200...850°C
Minimum span	10°C
Supply	7...40 VDC
Programmability	By FlexProgram
For further information please see data sheet for FlexTop 2212	

### ATEX data for temperature transmitters

#### Transmitter, type FlexTop 2202 - ATEX

Approval	Ex ia IIC T5/T6, ATEX II 1G Ex nA II T5, ATEX II 3G
Supply	8...28 VDC
Internal inductivity	$L_i \leq 10 \mu\text{H}$
Internal capacity	$C_i \leq 10 \text{nF}$
Temperature class	T1...T5: $-40 < T_{\text{amb}} < 85^\circ\text{C}$ T6: $-40 < T_{\text{amb}} < 50^\circ\text{C}$
Barrier data	U: $\leq 28 \text{VDC}$ I: $\leq 0.1\text{A}$ P: $\leq 0.75 \text{W}$

#### Transmitter, type FlexTop 2221 - ATEX

Approval	Ex ia IIC T5/T6, ATEX II 1G Ex nA II T5, ATEX II 3G
Supply	8...30 VDC (Ex nA : 12...30 VDC)
Internal inductivity	$L_i \leq 15 \mu\text{H}$
Internal capacity	$C_i \leq 5 \text{nF}$
Temperature class	T1...T5: $-40 < T_{\text{amb}} < 85^\circ\text{C}$ T6: $-40 < T_{\text{amb}} < 50^\circ\text{C}$
Barrier data	U: $\leq 30 \text{VDC}$ I: $\leq 0.1\text{A}$ P: $\leq 0.75 \text{W}$

#### Transmitter, type FlexTop 2211 - ATEX

Approval	Ex ia IIC T5/T6, ATEX II 1G Ex nA II T5, ATEX II 3G
Supply	6.5...30 VDC
Internal inductivity	$L_i \leq 15 \mu\text{H}$
Internal capacity	$C_i \leq 5 \text{nF}$
Temperature class	T1...T5: $-40 < T_{\text{amb}} < 85^\circ\text{C}$ T6: $-40 < T_{\text{amb}} < 50^\circ\text{C}$
Barrier data	U: $\leq 30 \text{VDC}$ I: $\leq 0.1\text{A}$ P: $\leq 0.75 \text{W}$

### Dimensions (mm) for process connections and immersion tube

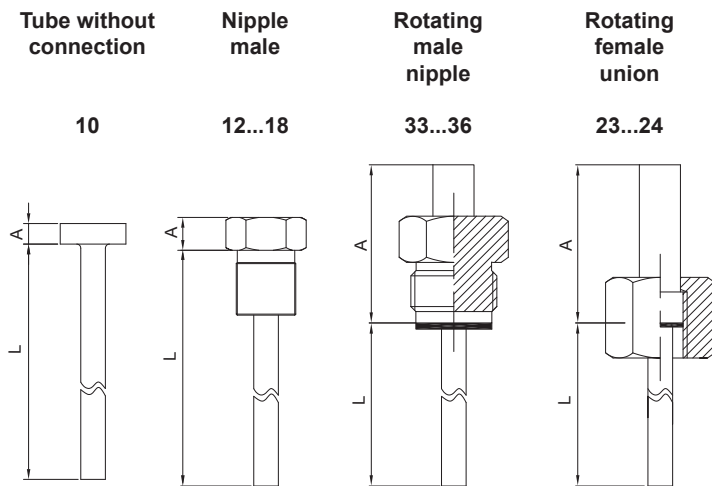

Connection	Code	A	A/F	L
Without	10	5	Ø18	20...3.000
G½, R½	12/13	10	22.0	35...3.000
M18, M20	16/17	10	22.0	35...3.000
½" NPT	18	10	22.0	35...3.000
G½ nipple	33	38	27.0	20...3.000
G¾ nipple	35	38	32.0	20...3.000
G1 nipple	36	38	36.0	20...3.000
G½ union	23	38	27.0	20...3.000
G¾ union	24	38	32.0	20...3.000

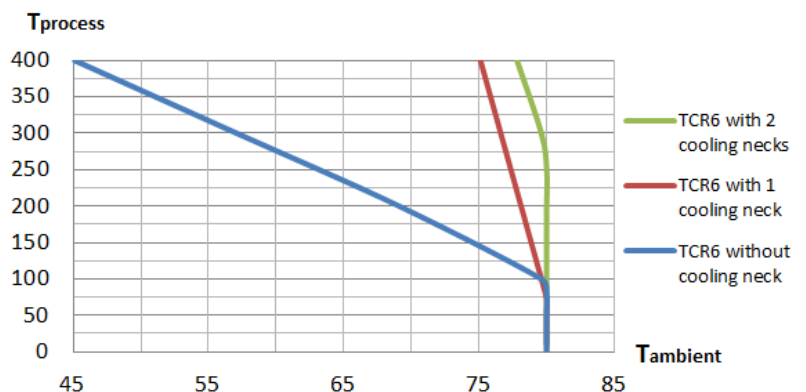
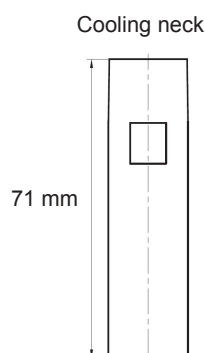
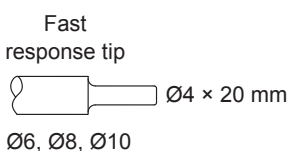
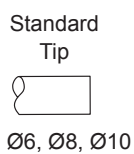

## Ordering details TCR6

TCR6	-	xxxx	.	x	x	x	x	.	x	x	xx	.	x	x	x	x	.	xxxx
<b>Model</b>																		
Standard temperature sensor, CombiTemp TCR6	TCR6	-																
<b>Electrical connection</b>																		
Cable gland, M16		1520																
Cable gland, M16, shielded		1620																
Cable gland, M20 (standard)		1720																
Cable gland, M16	for dual transmitter	2520																
Cable gland, M16, shielded	for dual transmitter	2620																
Cable gland, M20 (standard)	for dual transmitter	2720																
<b>Terminal block/Transmitter</b>																		
Flying leads	Pt100 output										0							
Ceramic terminal block	Pt100 output										1							
FlexTop 2202	4...20 mA	≤ ±0.25°C									2							
FlexTop 2211	4...20 mA	≤ ±0.10°C									3							
FlexTop 2221	4...20 mA + HART®	≤ ±0.10°C									4							
FlexTop 2212	4...20 mA / 20...4 mA	≤ ±0.06°C									6							
2 × FlexTop 2202	4...20 mA	≤ ±0.25°C									A							
2 × FlexTop 2211	4...20 mA	≤ ±0.10°C									B							
2 × FlexTop 2221	4...20 mA + HART®	≤ ±0.10°C									C							
2 × FlexTop 2212	4...20 mA / 20...4 mA	≤ ±0.06°C									D							
<b>Safety</b>																		
Standard											0							
ATEX, ia		Not available for dual transmitter									1							
ATEX, nA		Not available for dual transmitter									3							
Ex ia II 1 G Eex ia IIC, Zone 0, Simple apparatus		No transmitter									9							
<b>Configuration</b>																		
No configuration											0							
Configuration of range											1							
<b>Sensor element</b>																		
None (for Cable Sensor)											0							
1 × Pt100 Cl. B											1							
2 × Pt100 Cl. B											2							
1 × Pt100 Cl. 1/3 B											5							
2 × Pt100 Cl. 1/3 B											6							
1 × Pt100 Cl. 1/6 B											7							
2 × Pt100 Cl. 1/6 B											8							
1 × Pt100 Cl. A											A							
2 × Pt100 Cl. A											B							
1 × Pt100 Cl. B < 600°C											C							
1 × Pt1000, cl. B											J							
1 × Pt1000, cl. 1/3 B											K							
<b>Sensor insert type</b>																		
Embedded	2-wire	sensor element									1							
Embedded	4-wire	sensor element									2							
Embedded	2x2-wire	sensor element									4							
Insert, DIN 43762	2-wire	sensor element									5							
Insert, DIN 43762	4-wire	sensor element									6							
Insert, DIN 43762	2x2-wire	sensor element									7							
Cable sensor	4-wire, Ø8 mm only	Pt100, 1/1 DIN B									A							
Cable sensor	4-wire, Ø8 mm only	Pt100, 1/3 DIN B									B							
Cable sensor	4-wire, Ø8 mm only	Pt100, 1/6 DIN B									C							
Cable sensor	4-wire, Ø8 mm only	Pt100, 1/1 DIN A									D							
<b>Cooling neck</b>																		
None											0							
71 mm											1							
142 mm											2							
213 mm											3							
<b>Process connection</b>																		
Tube without connection																		10
Nipple, male	G½	DIN3852 form A																12
Nipple, male	R½	ISO 7/1																13
Nipple, male	M18×1.5	ISO 261																16
Nipple, male	M20×1.5	ISO 261																17
Nipple, male	½"NPT-14	ANSI/ASME B1.20.1																18
Rotating male nipple	G½	ISO 228/1 incl. NBR gasket																33
Rotating male nipple	G¾	ISO 228/1 incl. NBR gasket																35
Rotating male nipple	G1	ISO 228/1 incl. NBR gasket																36
Rotating female union	G½	ISO 228/1 incl. NBR gasket																23
Rotating female union	G¾	ISO 228/1 incl. NBR gasket																24
<b>Seal</b>																		
No seal																		0
NBR gasket		(-40...108°C) for rotating nipple and union only																1

Continued on page 5

## Ordering details TCR6

TCR6 - xxxx . x x x x . x x xx . x x x x . xxxx

Continued from page 4

### Sensor diameter

Ø6.0 mm	Welded	5
Ø8.0 mm	Welded	6
Ø10 mm	Welded	8

### Sensor tip

Standard	Normal response		1
Fast	Fast response	Not for cable sensor	2
Insert only	Open	No immersion tube below process connection	A

### Approvals

Without	0
Railway EN 50155	4

### Sensor tube length

Length in mm (e.g. 60 mm = 0060)

xxxx

## Insert TNR6, DIN 43762

For TCR6 standard RTD temperature sensor

### Insert as to DIN 43762, spring loaded

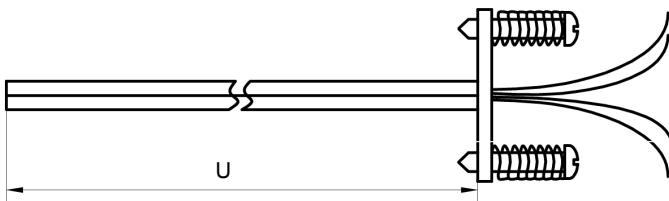

### Specifications

Material	AISI 316L (1.4404)
Sensor diameter	Ø5,6 mm
Sensor	As per below

## Ordering details TNR6

TNR6 - x x x x . x x x x

### Terminal block/Transmitter

Flying leads	Pt100 output		0
Ceramic terminal block	Pt100 output		1
FlexTop 2202	4...20 mA	≤ ±0.25°C	2
FlexTop 2211	4...20 mA	≤ ±0.10°C	3
FlexTop 2221	4...20 mA + HART®	≤ ±0.10°C	4
FlexTop 2212	4...20 mA / 20...4 mA	≤ ±0.06°C	6

### Configuration

No configuration	0
Configuration of range	1

### Sensor element

None (for Cable Sensor)	0
1 × Pt100 Cl. B	1
2 × Pt100 Cl. B	2
1 × Pt100 Cl. 1/3 B	5
2 × Pt100 Cl. 1/3 B	6
1 × Pt100 Cl. 1/6 B	7
2 × Pt100 Cl. 1/6 B	8
1 × Pt100 Cl. A	A
2 × Pt100 Cl. A	B
1 × Pt100 Cl. B < 600°C	C
1 × Pt1000, cl. B	J
1 × Pt1000, cl. 1/3 B	K

### Sensor insert type

Insert, DIN 43762	2-wire	sensor element	5
Insert, DIN 43762	4-wire	sensor element	6
Insert, DIN 43762	2x2-wire	sensor element	7

### Insert tube length

Length in mm

x x x x

Insert length, standard:	A + L + 26 mm
Insert length, with 1 cooling neck	A + L + 97 mm
Insert length, with 2 cooling necks	A + L + 168 mm
Insert length, with 3 cooling necks	A + L + 239 mm
For length A please see page 3	
For length L please see sensor length above for TCR6	



### Main features

- Stainless steel, AISI 316
- Robust design

### Applications

- For threaded process connection - Ø6 and Ø8 sensor
- For hygienic process connection - Ø6 sensor

### Dimensions (mm)

#### Threaded industrial type

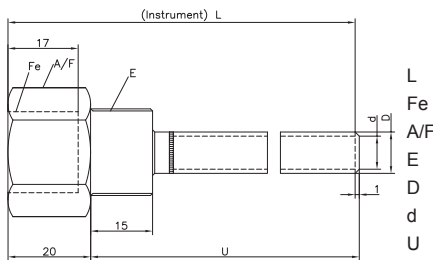

- L Instrument length, up to 3 m
- Fe G $\frac{1}{2}$
- A/F 27 mm
- E R $\frac{1}{2}$ , G $\frac{1}{2}$ A, G $\frac{3}{4}$ A or M20x1,5
- D Ø10 or Ø12 mm
- d Ø8 or Ø10 mm
- U Insertion length

#### Hygienic type, Clamp DN 25 / DN 38, Ra 0,8 µm

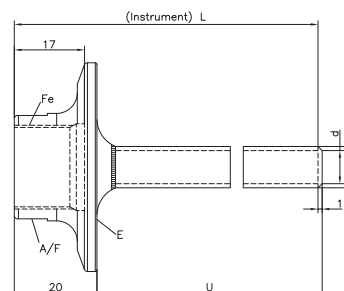

- L Instrument length, up to 3 m
- Fe G $\frac{1}{2}$
- A/F 25 mm
- E Clamp, ISO 2852 DN 38
- D Ø10 mm
- d Ø8 mm
- U Insertion length

### Ordering details ZPT4

ZPT4 - 5 xx 6 x . xxxx

#### Model

Thermowell

ZPT4

#### Instrument connection

Female thread G $\frac{1}{2}$

5

#### Process connection

R $\frac{1}{2}$  (½" BSPT)

14

G $\frac{1}{2}$

15

G $\frac{3}{4}$

34

M20x1.5

54

Clamp ISO 2852 DN 25/DN38

38

#### Material

Stainless steel AISI 316L/1.4404

6

#### Sensor diameter

Ø6 (outside Ø10 mm)

5

Ø8 (outside Ø12 mm)

7

#### Length (L)\*

mm (60 mm = 0060)

xxxx

\*When ordering the TCR6 with rotating male nipple (code 33) the length has to be L + 20 mm

## Mounting accessories: Compression gland

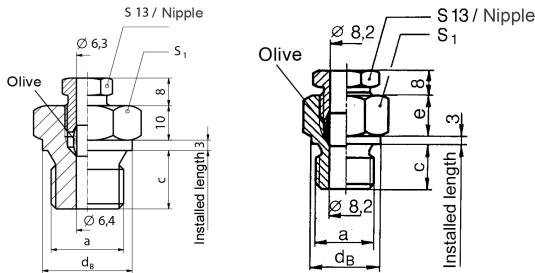

	A	C	D <sub>2</sub>	S <sub>1</sub>
6 mm sensor	G 1/2 A	15	26	27
-	G 3/4 A	16	32	32
-	G 1 A	19	39	41
-	1/2 NPT	20	-	27
-	M20	14	27	27
Ø8 mm sensor	G 1/4 A	13	19	19
-	G 1/2 A	15	26	27
-	G 3/4 A	16	32	32
-	1/4 NPT	16	-	17
-	1/2 NPT	20	-	27
-	M20	14	27	27

## Ordering details

		T08406	. X X X X
<b>Model</b>			
Compression gland		T 08406	
<b>Process connection</b>			
Ø6 mm sensor	G 1/2 A	0016	
-	G 3/4 A	0017	
-	G 1 A	0020	
-	1/2 NPT	0019	
-	M20	2020	
Ø8 mm sensor	G 1/4 A	1500	
-	G 1/2 A	0003	
-	G 3/4 A	0006	
-	1/4 NPT	1300	
-	1/2 NPT	0009	
-	M20	1020	

## Material

Material: AISI 316L (1.4435)

## Ventilation duct flange, Ø8 mm sensor only

Material: Stainless steel, AISI 316  
Sensor diameter: Ø 8mm



## Dimensions for ventilation duct flange

Ventilation duct flange Order: **ZPX1-002**

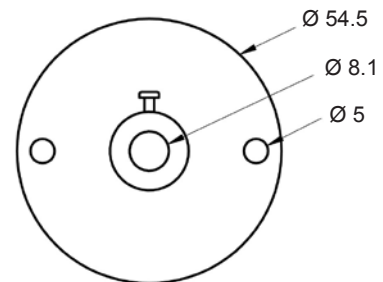

## Thermal compound

Recommended within the temperature range of -40 ... +180 °C



## Ordering details

**Model**  
Duct flange: ZPX1-002

## Ordering details for thermal compound

**Model**  
6 gram in plastic bag: ZPX1-001