

Absolute encoders - bus interfaces

Solid shaft $\varnothing 11$ mm with EURO flange B10 or housing foot B3

CANopen® / 13 bit ST / 16 bit MT / Speed switch

Number of pulses and switching speed freely programmable

PMG10P - CANopen®



PMG10P - picture similar

Technical data - electrical ratings

Voltage supply	10...30 VDC
Short-circuit proof	Yes
Consumption w/o load	≤ 200 mA
Initializing time	≤ 500 ms after power on
Interface	CANopen®
Function	Multiturn
Transmission rate	10...1000 kBaud
Device address	Rotary switches in bus connecting box
Steps per revolution	8192 / 13 bit
Number of revolutions	65536 / 16 bit
Additional outputs	Square-wave TTL/HTL, TTL/RS422
Sensing method	Magnetic
Interference immunity	EN 61000-6-2
Emitted interference	EN 61000-6-3
Programming interface	RS485 (≤ 600 m)
Programmable parameters	Bus system: see bus features Additional output (number of pulses), switch-off and switch-on speeds
Diagnostic function	Position or parameter error
Status indicator	DUO-LED (bus connecting box) 4 LEDs in device back side
Approval	CE

Technical data - electrical ratings (speed switches)

Switching accuracy	± 2 % (or 1 Digit)
Switching outputs	1 output (Open collector, solid state relay on request)
Output switching capacity	30 VDC; ≤ 100 mA
Switching delay time	≤ 20 ms

Features

- Interface CANopen®
- Magnetic sensing method
- Resolution: singleturn 13 bit, multiturn 16 bit
- Function display via LEDs
- Multiturn sensing with Energy Harvesting technology, without gear or battery
- Two-sided bearing system with hybrid bearings
- Special protection against corrosion C5-M

Optional

- Integrated speed switch programmable
- Additional output incremental programmable

Technical data - mechanical design

Size (flange)	$\varnothing 115$ mm
Shaft type	$\varnothing 11$ mm solid shaft
Flange	EURO flange B10 Housing foot B3
Protection DIN EN 60529	IP 66/IP 67
Operating speed	≤ 6000 rpm
Range of switching speed	ns (off) = ± 2 ...6000 rpm, factory setting 6000 rpm
Operating torque typ.	10 Ncm
Rotor moment of inertia	1 kgcm ²
Admitted shaft load	≤ 450 N axial ≤ 650 N radial
Materials	Housing: aluminium alloy Shaft: stainless steel
Corrosion protection	IEC 60068-2-52 Salt mist for ambient conditions C5-M (CX) according to ISO 12944-2
Operating temperature	-40...+85 °C
Relative humidity	95 % non-condensing
Resistance	IEC 60068-2-6 Vibration 30 g, 10-2000 Hz IEC 60068-2-27 Shock 400 g, 1 ms
Weight approx.	2.7 kg (depending on version)
Connection	Bus connecting box Terminal box incremental

Absolute encoders - bus interfaces

Solid shaft $\varnothing 11$ mm with EURO flange B10 or housing foot B3

CANopen® / 13 bit ST / 16 bit MT / Speed switch

Number of pulses and switching speed freely programmable

PMG10P - CANopen®

Part number

PMG10P -S . 1 C6 .3 00 .A

Additional output

- 0 Without
- 5 1024 ppr* TTL/HTL (Vin=Vout), 6 channels, electrically isolated
- 6 1024 ppr* TTL/RS422, 6 channels

Resolution multiturm

- 0 Without
- 6 16 bit

Voltage supply / interface

C6 10...30 VDC, CANopen® (DS 406)

Connection

- F 1x bus connecting box with 3 cable glands M16, radial + 1x terminal box with 1 cable gland M20, radial
- Z 1x bus connecting box with 2 connectors M12, radial + 1x terminal box with 1 cable gland M20, radial

Shaft diameter

1 $\varnothing 11$ mm with key 4 mm

Protection

- D IP 66 and IP 67, optimized for dusty environments
- L IP 66 and IP 67, optimized for oily and wet environments

Flange

- H EURO flange B10, shaft insulation hybrid bearing
- A Housing foot B3, shaft insulation hybrid bearing

Speed switch

- Without
- D With speed switch / switching speed 6000 rpm* (Standard: Open collector, solid state relay on request)

* Factory setting, programmable

Subject to modification in technic and design. Errors and omissions excepted.

Absolute encoders - bus interfaces

Solid shaft $\varnothing 11$ mm with EURO flange B10 or housing foot B3

CANopen® / 13 bit ST / 16 bit MT / Speed switch

Number of pulses and switching speed freely programmable

PMG10P - CANopen®

CANopen® - Terminal assignment

View A¹⁾ - View inside bus connecting box

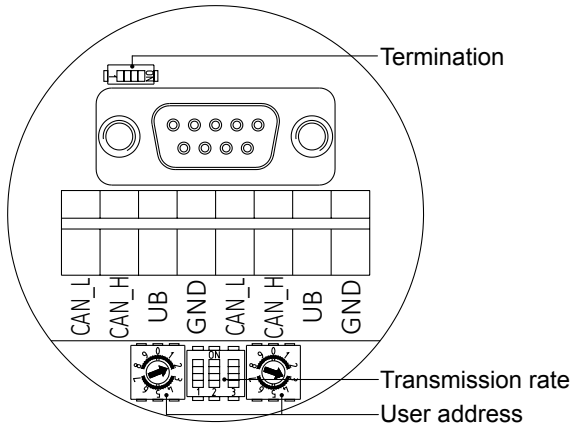

View A¹⁾ and A²⁾ - View into connector

male / female	Connection	Description
1	GND	Ground for UB
2	UB	Voltage supply 10...30 VDC
3	GND	Ground for UB
4	CAN_H	CAN Bus signal (dominant HIGH)
5	CAN_L	CAN Bus signal (dominant LOW)

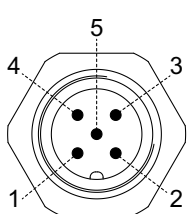

Connector M12 (male, A¹⁾)
5-pin, A-coded

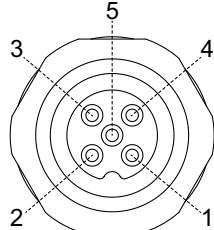

Connector M12 (female, A²⁾)
5-pin, A-coded

Terminals of the same significance are internally connected and identical in their functions. Max. load on the internal terminal connections UB-UB and GND-GND is 1 A each.

CANopen® - Features

Bus protocol	CANopen®
CANopen®-Features	Device Class 2 CAN 2.0B
Device profile	CANopen® CiA DSP 406, V 3.0
Operating mode	Polling mode (asynch, via SDO) Cyclic mode (asynch-cyclic) Synch mode (synch-cyclic) Acyclic mode (synch-acyclic)
Diagnosis	The encoder supports the following error warnings: - Position error
Factory setting	User address 00

CANopen® - Termination

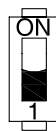

ON = final user
OFF = user x

CANopen® - User address

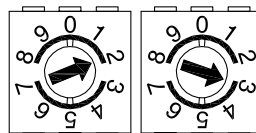

Defined by rotary switch.
Example: User address 23

CANopen® - Transmission rate

Transmission rate	Dip switch position		
	1	2	3
10 kBaud	OFF	OFF	OFF
20 kBaud	OFF	OFF	ON
50 kBaud*	OFF	ON	OFF
125 kBaud	OFF	ON	ON
250 kBaud	ON	OFF	OFF
500 kBaud	ON	OFF	ON
800 kBaud	ON	ON	OFF
1000 kBaud	ON	ON	ON

* Factory setting

¹⁾ See dimensions

Absolute encoders - bus interfaces

Solid shaft $\varnothing 11$ mm with EURO flange B10 or housing foot B3

CANopen® / 13 bit ST / 16 bit MT / Speed switch

Number of pulses and switching speed freely programmable

PMG10P - CANopen®

Speed switch / additional output incremental - Terminal significance

Ub ²⁾	Voltage supply
0V ²⁾	Ground
A+ ²⁾	Output signal channel 1
A- ²⁾	Output signal channel 1 inverted
B+ ²⁾	Output signal channel 2 (offset by 90° to channel 1)
B- ²⁾	Output signal channel 2 inverted
R+ ²⁾	Zero pulse (reference signal)
R- ²⁾	Zero pulse inverted
nE+	System OK+ / error output
nE-	System OK- / error output inverted
SP+ ³⁾	DSL_OUT1 / speed switch (Open collector, solid state relay on request)
SP- ³⁾	DSL_OUT2 / speed switch (0V, solid state relay on request)
SA	RS485+ / programming interface
SB	RS485- / programming interface
dnu	Do not use

Speed switch / additional output incremental - Terminal assignment terminal box

View B¹⁾

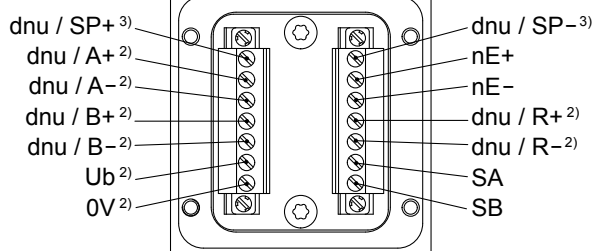

Additional output incremental - Trigger level

Trigger level	TTL/RS422
High / Low	≥ 2.5 V / ≤ 0.5 V
Transmission length	≤ 550 m @ 100 kHz
Output frequency	≤ 600 kHz
Trigger level	TTL/HTL (Vin = Vout)
High / Low	≥ 2.5 V / ≤ 0.5 V (TTL) $\geq U_b - 3$ V / ≤ 1.5 V (HTL)
Transmission length	≤ 550 m @ 100 kHz (TTL) ≤ 350 m @ 100 kHz (HTL)
Output frequency	≤ 600 kHz (TTL); ≤ 350 kHz (HTL)

Electrically isolated:
The output TTL/HTL (Vin = Vout) at the additional output incremental is electrically isolated and requires a separate power supply.

- ¹⁾ See dimensions
- ²⁾ Additional output incremental (option)
- ³⁾ Speed switch (option)

Additional output incremental - Output signals

Version with additional output incremental at positive rotating direction¹⁾

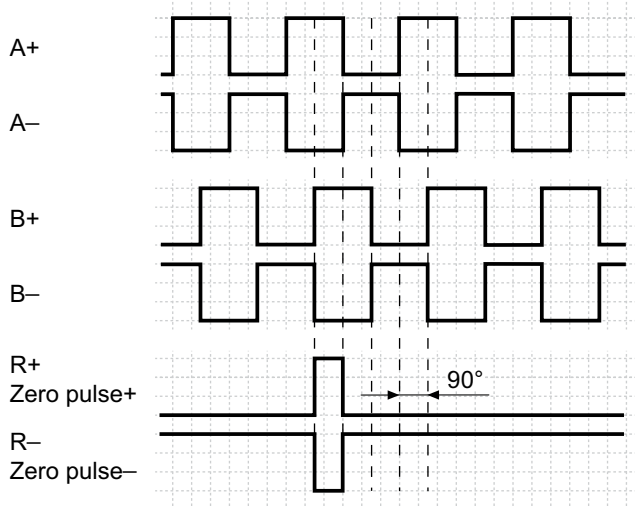

Speed switch - Switching characteristics

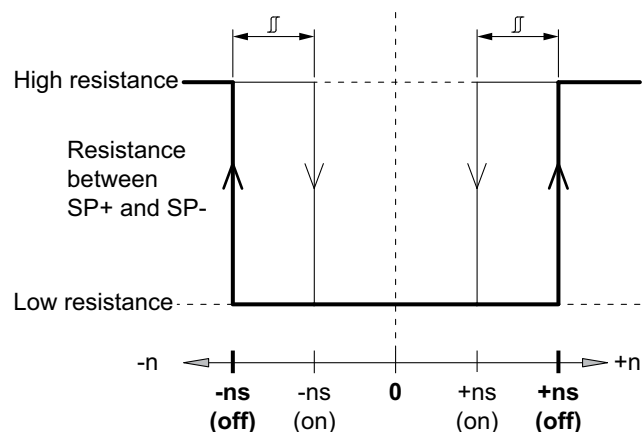

- n = Speed
- +ns (off) = Switch-off speed at shaft rotation in positive rotating direction¹⁾.
- ns (off) = Switch-off speed at shaft rotation in negative rotating direction¹⁾.

Switching hysteresis \square :
5...100 % (factory setting = 10 % min. 1 Digit)

- +ns (on) = Switch-on speed at shaft rotation in positive rotating direction¹⁾.
- ns (on) = Switch-on speed at shaft rotation in negative rotating direction¹⁾.

Absolute encoders - bus interfaces

Solid shaft $\varnothing 11$ mm with EURO flange B10 or housing foot B3

CANopen® / 13 bit ST / 16 bit MT / Speed switch

Number of pulses and switching speed freely programmable

PMG10P - CANopen®

Accessories

Connectors and cables

11191145	Adapter cable for programming the HMG10P/PMG10P bus interfaces series D-SUB connector (male) 15-pin with connecting cable, D-SUB connector (male) 9-pin and 7-pin connecting terminal
----------	--

Mounting accessories

K 35	Spring washer coupling for solid shaft $\varnothing 6 \dots 12$ mm
------	--

K 50	Spring washer coupling for solid shaft $\varnothing 11 \dots 16$ mm
------	---

K 60	Spring washer coupling for solid shaft $\varnothing 11 \dots 22$ mm
------	---

Programming accessories

11190106	Z-PA.SDL.1 - <i>WLAN-Adapter</i> Programming unit for xMG10P series
----------	--

Absolute encoders - bus interfaces

Solid shaft $\varnothing 11$ mm with EURO flange B10 or housing foot B3

CANopen® / 13 bit ST / 16 bit MT / Speed switch

Number of pulses and switching speed freely programmable

PMG10P - CANopen®

Dimensions

Version with EURO flange B10

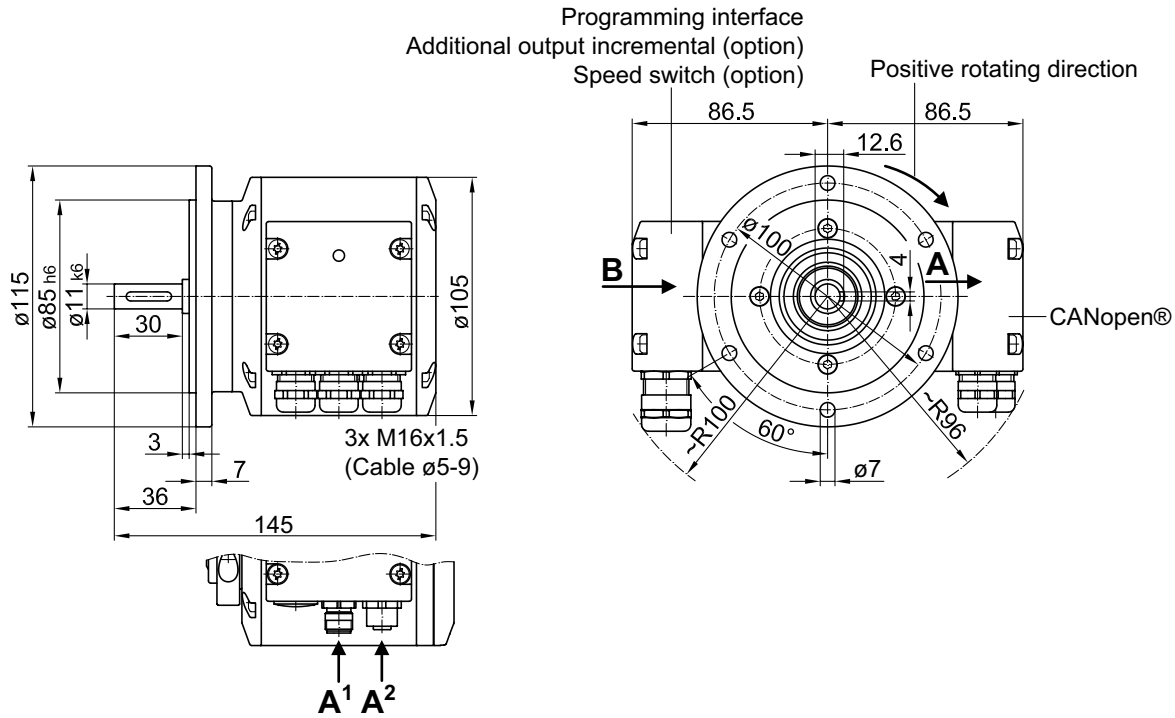

Version with housing foot B3

