

Distance sensors

OADM 20I5480/S14C

dimension drawing

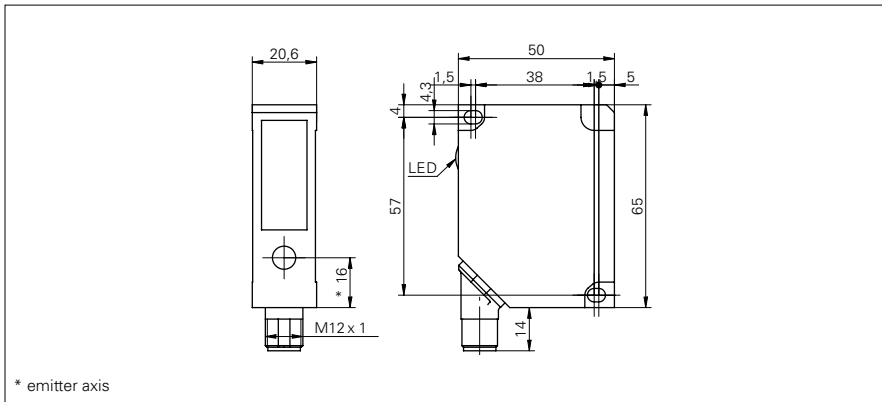

general data

measuring distance Sd	100 ... 600 mm
adjustment	no
power on indication	LED green
soiled lens indicator	LED red
resolution	0,2 ... 0,5 mm
linearity error	± 1,2 ... ± 7,2 mm
light source	pulsed red laser diode
wave length	650 nm
laser class	2
beam type	point
beam diameter	2 mm
temperature drift	< 0,06 % Sde/K

electrical data

response time / release time	< 10 ms
voltage supply range +Vs	12 ... 28 VDC
current consumption max. (no load)	100 mA
output circuit	analog
output signal	4 ... 20 mA
load resistance (analog I)	< (+Vs - 6 V) / 0,02 A
alarm output	PNP
short circuit protection	yes
reverse polarity protection	yes, Vs to GND

mechanical data

width / diameter	20,6 mm
height / length	65 mm
depth	50 mm
type	rectangular
housing material	die-cast zinc
front (optics)	glass
connection types	connector M12 5 pin, rotatable

ambient conditions

operating temperature	0 ... +50 °C
protection class	IP 67

photo



connection diagram

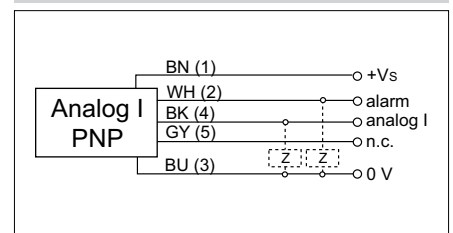

laser warning

