





EN	Operating Instructions	3
DE	Betriebsanleitung	11
IT	Istruzioni di funzionamento	19

Strain Probe DSRK

Simple strain measurement in deep holes

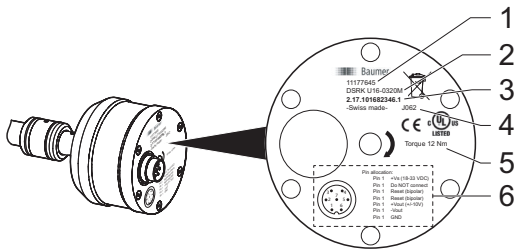
Type plate



- 1 ■ Material number
 - 2 ■ Type of sensor
 - 3 ■ Ordering number
 - 4 ■ Production code
 - 5 ■ Mounting torque
 - 6 ■ Pin assignment
-  ■ Do not dispose of in household waste



■ Conformity with EU directives



■ Permissions, customer-specific

- 1 ■ Materialnummer
- 2 ■ Sensortyp
- 3 ■ Auftragsnummer
- 4 ■ Produktionscode
- 5 ■ Anzugsmoment
- 6 ■ Pin-Belegung



■ Nicht im Hausmüll entsorgen



■ Konformität mit EU-Richtlinien



■ Zulassung Underwriters Laboratories (UL)

- 1 ■ Codice materiale
 - 2 ■ Tipo di sensore
 - 3 ■ Numero d'ordine
 - 4 ■ Codice produzione
 - 5 ■ Coppia di serraggio
 - 6 ■ Occupazione pin
-  ■ Non gettare tra i rifiuti domestici



■ Conformità con le direttive UE



■ Omologazione Underwriters Laboratories (UL)

Strain Probe DSRK

Simple strain measurement in deep holes

Table of contents

1. Safety	3	9. Electrical connection	7
2. Construction and function	3	10. Operation	8
3. Type of sensor	3	11. Dismantling	8
4. Compatibility	4	12. Troubleshooting dismantling	8
5. Symbols in warning signs	4	13. Maintenance and repair	9
6. Transport and storage	4	14. Disposal	9
7. Preparing for assembly	4	15. Accessories	9
8. Troubleshooting assembly	6	16. Technical data	9

1. Safety

Intended use

The strain probe must be used solely for measuring strains on machine elements.

Staff qualification

Only use staff who are trained for the activities described. This applies particularly to assembly and electrical connection.

Make sure that the staff have read and understood these instructions.

Technical condition

Only use strain probe in perfect technical condition. Only use Baumer accessories. Baumer will accept no liability for other manufacturers' accessories.

2. Construction and function

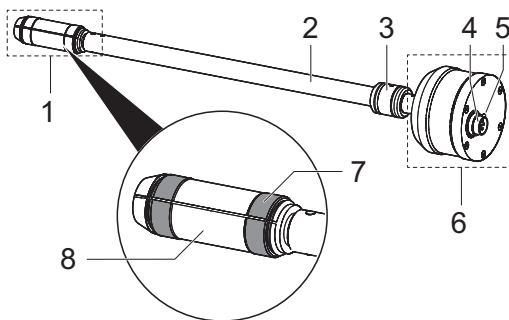

Fig. 1. Construction

- 1 Measuring head
- 2 Pipe
- 3 Supporting ring (DSRK x20 only)
- 4 Connector, 7 pin

The strain of the machine element is picked up on the inner wall of a hole via clamping collars (8) and scanning surfaces (7) and transmitted to strain measuring strips. These strain measuring strips are glued into the measuring head. Depending on the strain an electrical signal is generated that is converted into a standardized output signal within the housing (6). The scanning point for the measurement can be optimally selected using tubes of different lengths (2).

- 5 Hexagon socket SW 6
- 6 Housing
- 7 Scanning surfaces
- 8 Clamping collars

3. Type of sensor

DSRK U16-0320M

1
 2
 3

- 1 Output signal U or I
- 2 Measuring head diameter in mm
- 3 Measuring point depth in mm

Fig. 2. Example of sensor type

Strain Probe DSRK

Simple strain measurement in deep holes

4. Compatibility

The DSRK strain probe is fully compatible with older strain probes in the DSRH series.

For installation notes see Page 5.

5. Symbols in warning signs

Symbol	Warning term	Explanation
	DANGER	In situations which cause death or serious injuries.
	WARNING	In situations which can cause death or serious injuries.
	CAUTION	In situations which can cause light or medium injuries.
	ATTENTION	For material damage

6. Transport and storage

- ▶ **ATTENTION!** Function errors via contaminated measuring head. Do not touch scanning surfaces on the measuring head with bare hands. Follow safety instructions on the packaging.
- ▶ Check packaging and strain probe for damage.
- ▶ In the event of damage: Do not use strain probe.
- ▶ Transport or store strain probe only in original packaging.
- ▶ Store strain probe where it will be secure against shock.
 Storage temperature: -40 ... +85 °C
 Relative humidity: < 98 %

7. Preparing for assembly

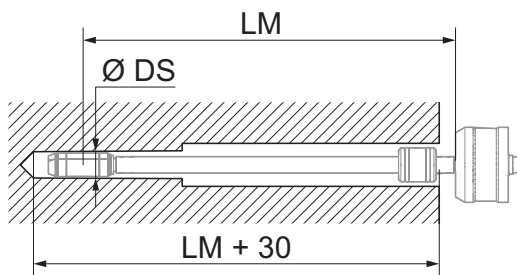

- ▶ Prepare bore in the machine element or strut.
 Length of hole: LM + 30 mm
 Roughness: $r_a = 3.2 \mu\text{m}$
 Diameter precision at hole end: $0/+0.35 \text{ mm}$

Fig. 3. Hole in the machine element

LM Depth of measuring point
 \varnothing DS Measuring head diameter

7.1 Assembly

ATTENTION

False measurement results via contaminated measuring head or incorrect assembly

- ▶ Avoid contamination from grease or oil.
- ▶ Do not touch scanning surfaces on the measuring head with bare hands.
- ▶ The machine element must not touch the strain probe housing after assembly.

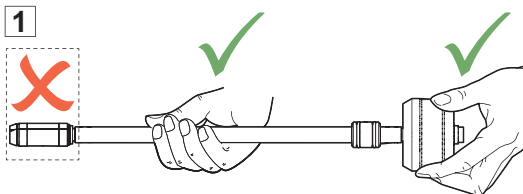

- ✓ Hole must be prepared.
- ▶ Carefully take strain probe out of the packaging. When doing so, follow safety instructions on the packaging.

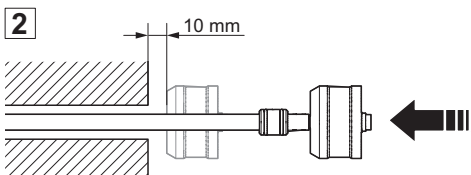

- ▶ Insert strain probe into the hole with a slow continuous movement.
- ▶ Insert strain probe so far that 10mm of the tube of the probe remains visible.

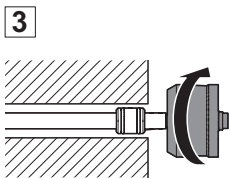

- ▶ Turn sensor housing in clockwise until back pressure becomes noticeable.

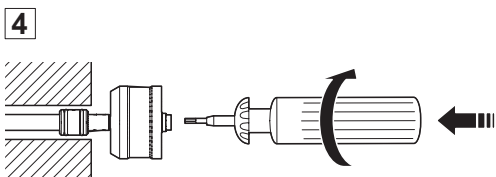

- ▶ **ATTENTION!** Excessive tightening torque can damage the measuring head. Keep precisely to the specified tightening torque.
- ▶ Tension strain probe with torque wrench (hexagon socket SW6).
Tightening torque: 12 Nm.

Strain Probe DSRK

Simple strain measurement in deep holes

8. Troubleshooting assembly

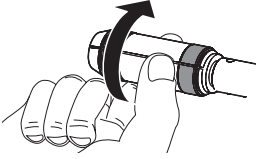
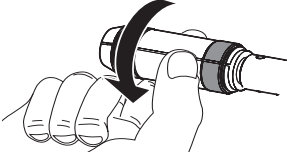
Problem	Cause	Action
Strain probe cannot be fully inserted into the hole.	Tensioning mechanism is not fully relaxed.	<ul style="list-style-type: none"> ▶ ATTENTION! Measuring error via contaminated measuring head. Do not touch scanning surfaces on the measuring head with bare hands. ▶ Take the measuring head between the scanning surfaces and carefully rotate a half to a full turn.  <ul style="list-style-type: none"> ▶ Insert strain probe into the hole again.
Strain probe cannot be clamped.	Clamping collars do not extend.	<ul style="list-style-type: none"> ▶ Remove strain probe from the hole. ▶ ATTENTION! Measuring error via contaminated measuring head. Do not touch scanning surfaces on the measuring head with bare hands. ▶ Take the measuring head between the scanning surfaces and carefully rotate a quarter to a half turn.  <p>The clamping collars will come apart.</p>

Strain Probe DSRK

Simple strain measurement in deep holes

9. Electrical connection

- ✓ A voltage supply of 18 V to 33 V DC is provided.
- ▶ Switch off supply voltage.
- ▶ Connect strain probe in accordance with pin assignment or cable color.

Terminal assignment

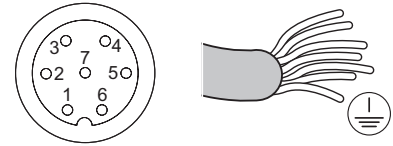

Reset	DSRK Uxx equivalent circuits	7 pin	Cable color
Electri- cally isolated		1 2 3 4 5 6 7	White Brown Green Yellow Grey Blue Pink

Non-elec- trically isolated		1 2 3 4 5 6 7	White Brown Green Yellow Grey Blue Pink
--	--	---------------------------------	---

Reset	DSRK Ixx equivalent circuits	7 pin	Cable color
Electri- cally isolated		1 2 3 4 5 6 7	White Brown Green Yellow Grey Blue Pink

Non-elec- trically isolated		1 2 3 4 5 6 7	White Brown Green Yellow Grey Blue Pink
--	--	---------------------------------	---

Strain Probe DSRK

Simple strain measurement in deep holes

10. Operation

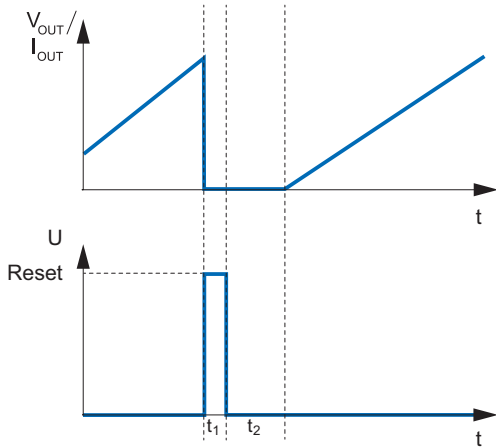

Fig. 4. Reset

To avoid measuring errors due to temperature changes, Baumer recommends calibrating the strain probe's output signal after each machine cycle. This sets the output signal to zero.

V_{out}/I_{OUT} Output signal
 t_1 Reset pulse (> 1 ms)

t_2 Waiting time for receiving new measurement signal (> 15 ms)

11. Dismantling

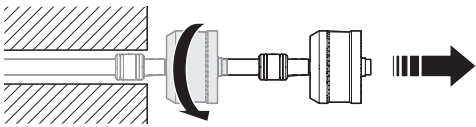

- ▶ **ATTENTION!** Damage to strain probe. Dismantle and reuse a maximum of 3 times.
- ▶ Disconnect strain probe from the power supply.
- ▶ Turn housing in counter-clockwise direction. When doing so a higher torque is necessary at the start to loosen the measuring head.
- ▶ Turn housing approximately 3 full turns.
- ▶ Pull strain probe out of the hole with a light tug.

12. Troubleshooting dismantling

Problem	Cause	Action
Strain probe cannot be pulled out.	Scanning surfaces of the tensioning mechanism are wedged.	▶ Lightly hit the housing with a rubber mallet until the scanning surfaces loosen.

Strain Probe DSRK

Simple strain measurement in deep holes

13. Maintenance and repair

Maintenance

Regular maintenance is not required.

Repair

Do not repair the strain probe yourself.

- ▶ Send damaged strain probe to Baumer.

14. Disposal



- ▶ Do not dispose of in household waste.
- ▶ Separate materials and dispose of in compliance with nationally applicable regulations.

15. Accessories

For accessories see www.baumer.com.

16. Technical data

Environmental conditions

Operating temperature range ■ -5 ... +85 °C

Storage temperature range ■ -40 ... +85 °C

Relative humidity ■ < 98%

Protection class ■ IP54

Electrical data

Measurement range ■ 0 ... 1000 $\mu\epsilon$

Reset input ■ 15 ... 45 V DC

Reset active ■ > ± 15 V DC

Reset inactive ■ < ± 5 V DC

Reset pulse ■ > 1 ms

Power supply

Voltage supply range ■ 18 ... 33 V DC

Current consumption ■ < 50 mA (DSRK U)
■ < 50 mA (DSRK I)

Connection

Connector ■ Binder type, series 680/SGR 70, 7-pin

Strain Probe DSRK

Simple strain measurement in deep holes

Inhaltsverzeichnis

1. Sicherheit	11	9. Elektrischer Anschluss	15
2. Aufbau und Funktion	11	10. Betrieb	16
3. Sensortyp	11	11. Demontage	16
4. Kompatibilität	12	12. Problembehebung bei Demontage	16
5. Symbole in Warnhinweisen	12	13. Wartung und Reparatur	17
6. Transport und Lagerung	12	14. Entsorgung	17
7. Montage vorbereiten	12	15. Zubehör	17
8. Problembehebung bei Montage	14	16. Technische Daten	17

1. Sicherheit

Bestimmungsgemässe Verwendung

Die Messlanze darf ausschliesslich zur Messung von Dehnungen an Maschinenelementen verwendet werden.

Personalqualifikation

Nur Personal einsetzen, das für die beschriebenen Tätigkeiten geschult ist. Dies gilt insbesondere für Montage und elektrischen Anschluss.

Sicherstellen, dass das Personal diese Anleitung gelesen und verstanden hat.

Technischer Zustand

Messlanze nur in einwandfreiem technischem Zustand verwenden. Nur Zubehör von Baumer verwenden. Für Zubehör anderer Hersteller übernimmt Baumer keine Haftung.

2. Aufbau und Funktion



Abb. 1. Aufbau

- | | | | |
|---|--------------------------|---|---------------------|
| 1 | Messkopf | 5 | Innensechskant SW 6 |
| 2 | Rohr | 6 | Gehäuse |
| 3 | Stützring (nur DSRK x20) | 7 | Abgriffflächen |
| 4 | Anschlussstecker, 7 Pin | 8 | Spannschalen |

Über Spannschalen (8) und Abgriffflächen (7) wird die Dehnung des Maschinenelements an der Innenwand einer Bohrung abgegriffen und auf Dehnungsmessstreifen übertragen. Diese Dehnungsmessstreifen sind in den Messkopf eingeklebt. Abhängig von der Dehnung wird ein elektrisches Signal erzeugt, das im Gehäuse (6) in ein standardisiertes Ausgangssignal gewandelt wird. Durch verschieden lange Rohre (2) kann der Abgriffpunkt für die Messung optimal gewählt werden.

3. Sensortyp

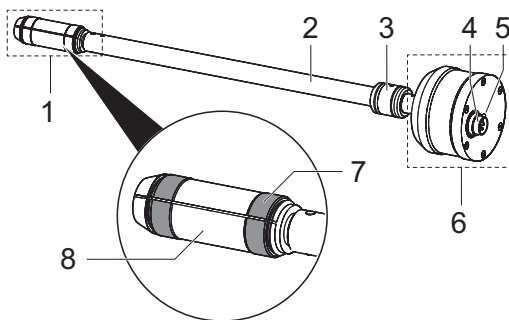
DSRK U16-0320M

1 2 3

Abb. 2. Beispiel für Sensortyp

- | | |
|---|----------------------------|
| 1 | Ausgangssignal U oder I |
| 2 | Durchmesser Messkopf in mm |
| 3 | Messpunkttiefe in mm |

Messlanze DSRK

Einfache Dehnungsmessung in tiefen Bohrungen

4. Kompatibilität

Die Messlanze DSRK ist vollständig kompatibel zu älteren Messlanzen der Baureihe DSRH. Montagehinweise siehe Seite 13.

5. Symbole in Warnhinweisen

Symbol	Warnwort	Erklärung
	GEFAHR	Bei Situationen, die zum Tod oder zu schweren Verletzungen führen.
	WARNUNG	Bei Situationen, die zum Tod oder zu schweren Verletzungen führen können.
	VORSICHT	Bei Situationen, die zu leichten oder mittelschweren Verletzungen führen können.
	ACHTUNG	Bei Sachschäden

6. Transport und Lagerung

- ▶ **ACHTUNG!** Funktionsstörungen durch verschmutzten Messkopf. Abgriffflächen am Messkopf nicht mit den Händen berühren. Hinweise auf der Verpackung beachten.
- ▶ Verpackung und Messlanze auf Beschädigungen prüfen.
- ▶ Bei Beschädigung: Messlanze nicht verwenden.
- ▶ Messlanze nur in Originalverpackung transportieren oder lagern.
- ▶ Messlanze stossicher lagern.
Lagertemperatur: -40 ... +85 °C
Relative Luftfeuchtigkeit: <98 %

7. Montage vorbereiten

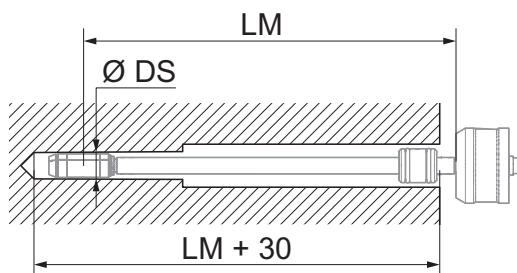

- ▶ Bohrung im Maschinenelement bzw. Holm vorbereiten.
Länge Bohrloch: LM + 30 mm
Rauigkeit: $r_a = 3,2 \mu\text{m}$
Durchmessergenauigkeit am Bohrlochende: $0/+0,35 \text{ mm}$

Abb. 3. Bohrung im Maschinenelement

LM Messpunkttiefe

Ø DS Durchmesser Messkopf

7.1 Montage

ACHTUNG

Falsche Messergebnisse durch verschmutzten Messkopf oder falsche Montage

- ▶ Verschmutzungen durch Fett oder Öl vermeiden.
- ▶ Abgriffflächen am Messkopf nicht mit den Händen berühren.
- ▶ Gehäuse der Messlanze darf das Maschinenelement nach der Montage nicht berühren.

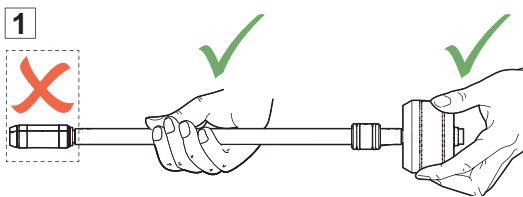

- ✓ Bohrloch ist vorbereitet.
- ▶ Messlanze vorsichtig aus der Verpackung nehmen. Dabei Hinweise auf der Verpackung beachten.

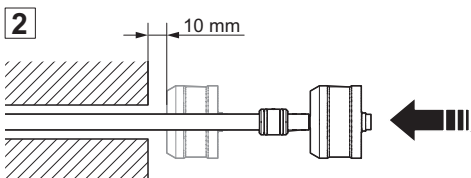

- ▶ Messlanze mit einer langsamen, kontinuierlichen Bewegung in das Bohrloch einführen.
- ▶ Messlanze so weit einführen, dass das Rohr der Messlanze 10 mm sichtbar bleibt.

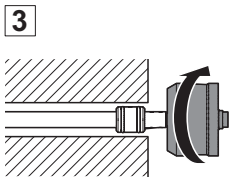

- ▶ Gehäuse des Sensors im Uhrzeigersinn drehen, bis Gegendruck spürbar wird.

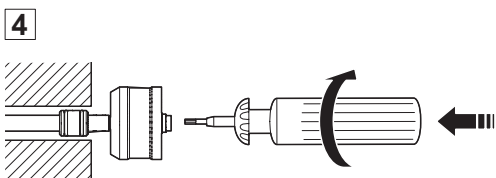

- ▶ **ACHTUNG!** Beschädigung des Messkopfs durch zu grosses Anzugsmoment. Angegebenes Anzugsmoment genau einhalten.
- ▶ Messlanze mit Drehmomentschlüssel (Innensechskant SW6) spannen. Anzugsmoment: 12 Nm.

Messlanze DSRK

Einfache Dehnungsmessung in tiefen Bohrungen

8. Problembehebung bei Montage

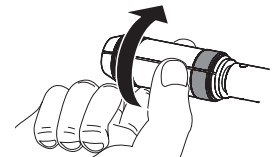
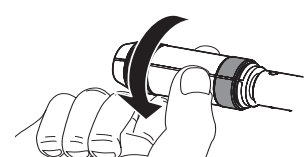
Problem	Ursache	Massnahme
Messlanze kann nicht vollständig in die Bohrung eingeführt werden.	Spannmechanismus ist nicht vollständig entspannt.	<ul style="list-style-type: none"> ▶ ACHTUNG! Messfehler durch verschmutzten Messkopf. Abgriffflächen am Messkopf nicht mit den Händen berühren. ▶ Messkopf zwischen den Abgriffflächen fassen und vorsichtig eine halbe bis eine ganze Umdrehung drehen.  <ul style="list-style-type: none"> ▶ Messlanze erneut in die Bohrung einführen.
Messlanze lässt sich nicht verspannen.	Spannschalen fahren nicht aus.	<ul style="list-style-type: none"> ▶ Messlanze aus der Bohrung herausziehen. ▶ ACHTUNG! Messfehler durch verschmutzten Messkopf. Abgriffflächen am Messkopf nicht mit den Händen berühren. ▶ Messkopf zwischen den Abgriffflächen fassen und um eine viertel oder halbe Umdrehung drehen.  <p>Die Spannschalen fahren etwas auseinander.</p>

9. Elektrischer Anschluss

- ✓ Betriebsspannung 18 V bis 33 V DC ist bereitgestellt.
- ▶ Betriebsspannung ausschalten.
- ▶ Messlanze laut Pin-Belegung oder Kabelfarbe anschliessen.

Anschlussbelegung

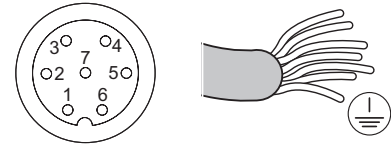

Reset	Ersatzschaltbilder DSRK Uxx	7 Pin	Kabelfarbe
Galvanisch getrennt		1	Weiss
		2	Braun
		3	Grün
		4	Gelb
		5	Grau
		6	Blau
		7	Rosa
Nicht galvanisch getrennt		1	Weiss
		2	Braun
		3	Grün
		4	Gelb
		5	Grau
		6	Blau
		7	Rosa
Galvanisch getrennt		1	Weiss
		2	Braun
		3	Grün
		4	Gelb
		5	Grau
		6	Blau
		7	Rosa
Nicht galvanisch getrennt		1	Weiss
		2	Braun
		3	Grün
		4	Gelb
		5	Grau
		6	Blau
		7	Rosa

Messlanze DSRK

Einfache Dehnungsmessung in tiefen Bohrungen

10. Betrieb



Abb. 4. Reset

V_{out}/I_{OUT} Ausgangssignal
 t_1 Reset-Puls (> 1 ms)

t_2 Wartezeit für Empfang neues Messsignal (> 15 ms)

Um Messfehler durch Temperaturänderungen zu vermeiden, empfiehlt Baumer das Ausgangssignal der Messlanze nach jedem Maschinenzyklus neu zu tarieren. Damit wird das Ausgangssignal auf Null gesetzt.

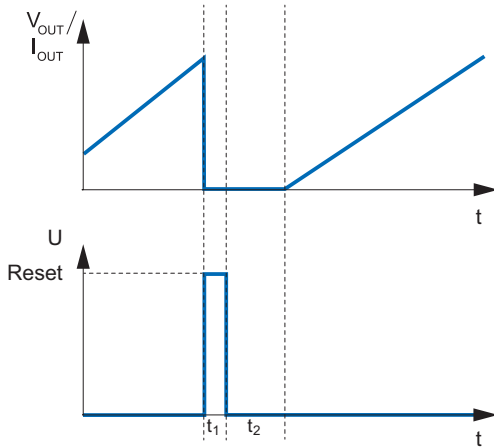
11. Demontage

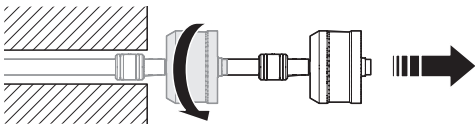

- ▶ **ACHTUNG!** Beschädigung der Messlanze. Maximal 3 Mal demontieren und wiederverwenden.
- ▶ Messlanze von der Spannungsversorgung trennen.
- ▶ Gehäuse im Gegenuhrzeigersinn drehen. Dabei ist zu Beginn ein höheres Drehmoment notwendig, um den Messkopf zu lösen.
- ▶ Gehäuse ungefähr 3 volle Umdrehungen drehen.
- ▶ Messlanze mit einem leichten Zug aus der Bohrung herausziehen.

12. Problembehebung bei Demontage

Problem	Ursache	Massnahme
Messlanze lässt sich nicht herausziehen.	Abgriffflächen des Spannmehanismus sind verkeilt.	<ul style="list-style-type: none"> ▶ Mit einem Gummihammer leicht auf das Gehäuse schlagen, bis sich die Abgriffflächen lösen.

13. Wartung und Reparatur

Wartung

Eine regelmässige Wartung ist nicht erforderlich.

Reparatur

Die Messlanze nicht selbst reparieren.

- ▶ Beschädigte Messlanze an Baumer senden.

14. Entsorgung



- ▶ Nicht im Hausmüll entsorgen.
- ▶ Materialien trennen und entsprechend den national geltenden Vorschriften entsorgen.

15. Zubehör

Zubehör siehe www.baumer.com.

16. Technische Daten

Umgebungsbedingungen

Betriebstemperaturbereich	■ -5 ... +85 °C
Lagertemperaturbereich	■ -40 ... +85 °C
Relative Luftfeuchtigkeit	■ < 98 %
Schutzart	■ IP54

Speisung

Betriebsspannungsbereich	■ 18 ... 33 V DC
Stromaufnahme	■ < 50 mA (DSRK U) ■ < 50 mA (DSRK I)

Elektrische Daten

Messbereich	■ 0 ... 1000 $\mu\epsilon$
Reset-Eingang	■ 15 ... 45 V DC
Reset aktiv	■ > ± 15 V DC
Reset inaktiv	■ < ± 5 V DC
Reset-Puls	■ > 1 ms

Anschluss

Anschlussstecker	■ Typ Binder, Serie 680/SGR 70, 7-polig
------------------	---

Messlanze DSRK

Einfache Dehnungsmessung in tiefen Bohrungen

Sommario

1. Sicurezza	19	9. Allacciamento elettrico	23
2. Struttura e funzionamento	19	10. Funzionamento	24
3. Tipo di sensore	19	11. Smontaggio	24
4. Compatibilità	20	12. Risoluzione dei problemi durante lo smontaggio	24
5. Simboli delle avvertenze	20	13. Manutenzione e riparazione	25
6. Trasporto e stoccaggio	20	14. Smaltimento	25
7. Preparazione del montaggio	20	15. Accessori	25
8. Risoluzione dei problemi durante il montaggio	22	16. Dati tecnici	25

1. Sicurezza

Utilizzo conforme alla destinazione d'uso

La sonda di misura deve essere utilizzata esclusivamente per la misurazione delle deformazioni insorte negli elementi della macchina.

Qualifica del personale

Impiegare soltanto del personale appositamente formato per le attività descritte. Ciò vale in particolar modo per le attività di montaggio e allacciamento elettrico.

Accertarsi che il personale abbia letto e compreso le presenti istruzioni di funzionamento.

Condizioni tecniche

Utilizzare la sonda di misura soltanto se è in condizioni tecniche ineccepibili. Utilizzare esclusivamente gli accessori Baumer. Baumer non risponde di accessori di altri marchi.

2. Struttura e funzionamento

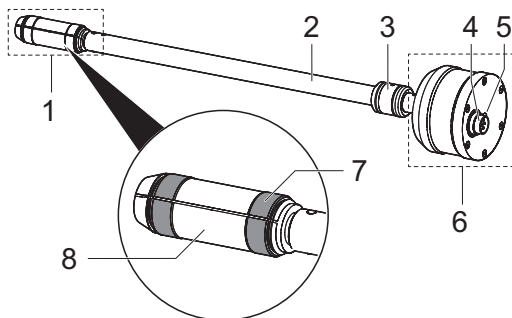

Fig. 1. Struttura

- | | | | |
|---|----------------------------------|---|-----------------------|
| 1 | Testina di misura | 5 | Chiave a brugola SW 6 |
| 2 | Asta | 6 | Corpo |
| 3 | Anello di tenuta (solo DSRK x20) | 7 | Superfici di presa |
| 4 | Spinotto di collegamento, 7 Pin | 8 | Gusci di serraggio |

La deformazione dell'elemento della macchina viene rilevata tramite gusci di serraggio (8) e superfici di presa (7) sulla parete interna di un foro e trasmessa su apposite strisce di misura. Tali strisce sono incollate nella testina di misura. A seconda della deformazione rilevata, viene emesso un segnale elettrico che viene trasformato in un segnale d'uscita standardizzato all'interno del corpo (6). Le aste disponibili in varie lunghezze (2) consentono di scegliere il punto di rilevazione ideale per la misurazione.

3. Tipo di sensore

DSRK U16-0320M

1 2 3

- | | |
|---|--------------------------------------|
| 1 | Segnale d'uscita U o I |
| 2 | Diametro testina in mm |
| 3 | Profondità del punto di misura in mm |

Fig. 2. Esempio di un tipo di sensore

4. Compatibilità

La sonda di misura DSRK è perfettamente compatibile con le sonde precedenti della serie DSRH.

Per le istruzioni di montaggio vedi pagina 21.

5. Simboli delle avvertenze

Simbolo	Termine	Spiegazione
	PERICOLO	Situazioni che portano alla morte o a gravi lesioni.
	AVVERTENZA	Situazioni che possono portare alla morte o a gravi lesioni.
	CAUTELA	Situazioni che possono portare a lesioni lievi o di media entità.
	ATTENZIONE	Danni a cose

6. Trasporto e stoccaggio

- ▶ **ATTENZIONE!** Anomalie di funzionamento dovute ad una testina imbrattata. Non toccare con le mani le superfici di presa sulla testina. Osservare le indicazioni riportate sulla confezione.
- ▶ Verificare l'eventuale presenza di danni su confezione e sonda.
- ▶ In caso di danni: non utilizzare la sonda.
- ▶ Trasportare o immagazzinare la sonda soltanto nella confezione originale.
- ▶ Immagazzinare la sonda al riparo da eventuali urti.
 Temperatura di stoccaggio: -40 ... +85 °C
 Umidità relativa: <98 %

7. Preparazione del montaggio

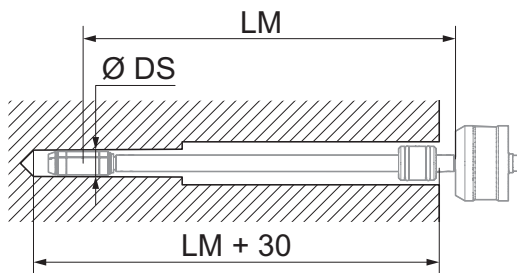

- ▶ Preparare il foro nell'elemento della macchina o nel manicotto.
 Lunghezza foro: $LM + 30$ mm
 Rugosità: $ra = 3,2 \mu m$
 Precisione diametro alla fine del foro: $0/+0,35$ mm

Fig. 3. Foro nell'elemento della macchina

LM Profondità del punto di misura

Ø DS Diametro testina

7.1 Montaggio

ATTENZIONE

Risultati di misura errati dovuti ad una testina imbrattata o ad un montaggio errato

- ▶ Evitare eventuali imbrattamenti da grassi od oli.
- ▶ Non toccare con le mani le superfici di presa sulla testina.
- ▶ Dopo il montaggio il corpo della sonda di misura non deve essere a contatto con l'elemento della macchina.

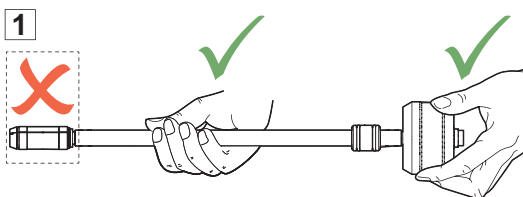

- ✓ Il foro è pronto.
- ▶ Estrarre con cautela la sonda dalla confezione. Osservare le indicazioni riportate sulla confezione.

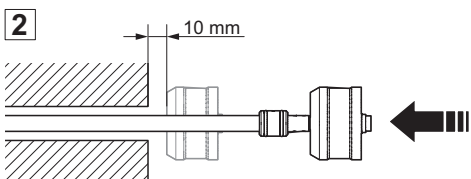

- ▶ Inserire la sonda nel foro con un movimento lento e continuo.
- ▶ Introdurre la sonda finché rimangono visibili 10 mm dell'asta della sonda.

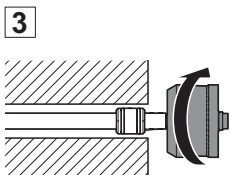

- ▶ Ruotare il corpo del sensore in senso orario fino a percepire una contropressione.

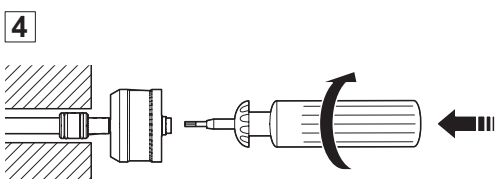

- ▶ **ATTENZIONE!** Danneggiamento della testina dovuto ad una coppia di serraggio troppo elevata. Rispettare esattamente la coppia di serraggio indicata.
- ▶ Serrare la sonda con la chiave torsometrica (chiave a brugola SW6).
Coppia di serraggio: 12 Nm.

8. Risoluzione dei problemi durante il montaggio

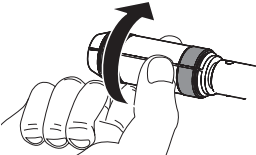
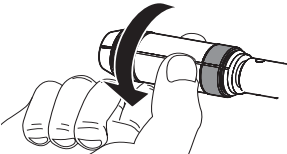
Problema	Causa	Risoluzione
Impossibile inserire completamente la sonda nel foro.	Il meccanismo di serraggio non è completamente allentato.	<ul style="list-style-type: none"> ▶ ATTENZIONE! Errore di misura dovuto alla testina imbrattata. Non toccare con le mani le superfici di presa sulla testina. ▶ Afferrare la testina fra le superfici di presa e ruotare con cautela di mezzo o massimo di un giro completo.  <ul style="list-style-type: none"> ▶ Inserire nuovamente la sonda nel foro.
Impossibile tendere la sonda.	I gusci di serraggio non si aprono.	<ul style="list-style-type: none"> ▶ Estrarre la sonda dal foro. ▶ ATTENZIONE! Errore di misura dovuto alla testina imbrattata. Non toccare con le mani le superfici di presa sulla testina. ▶ Afferrare la testina fra le superfici di presa e ruotare di un quarto o di mezzo giro.  <p>I gusci di serraggio si aprono leggermente.</p>

9. Collegamento elettrico

- ✓ La tensione di alimentazione da 18 V a 33 V DC è disponibile.
- ▶ Disattivare la tensione di alimentazione.
- ▶ Collegare la sonda in base all'occupazione pin o al colore del cavo.

Occupazione collegamenti

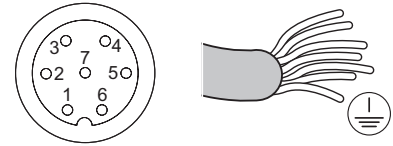

Reset	Schemi elettrici sostitutivi DSRK Uxx	7 pin	Colore del cavo
Isolato in tensione continua		1 2 3 4 5 6 7	Bianco Marrone Verde Giallo Grigio Blu Rosa
Non isolato in tensione continua		1 2 3 4 5 6 7	Bianco Marrone Verde Giallo Grigio Blu Rosa
Isolato in tensione continua		1 2 3 4 5 6 7	Bianco Marrone Verde Giallo Grigio Blu Rosa
Non isolato in tensione continua		1 2 3 4 5 6 7	Bianco Marrone Verde Giallo Grigio Blu Rosa

10. Funzionamento

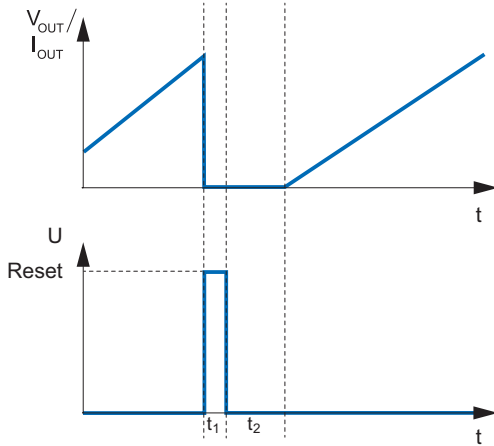

Fig. 4. Reset

Per evitare degli errori di misura dovuti a variazioni della temperatura, Baumer consiglia di ritardare il segnale d'uscita della sonda dopo ciascun ciclo della macchina. Ciò consente di azzerare il segnale d'uscita.

V_{out}/I_{OUT} Segnale d'uscita
 t_1 Impulso reset (> 1 ms)

t_2 Tempo di attesa per la ricezione del nuovo segnale di misura (> 15 ms)

11. Smontaggio

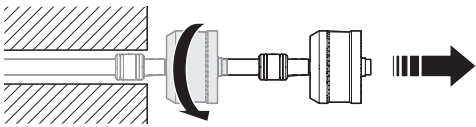

- ▶ **ATTENZIONE!** Danneggiamento della sonda. Smontare e riutilizzare al massimo per 3 volte.
- ▶ Staccare la sonda dall'alimentazione di tensione.
- ▶ Ruotare il corpo in senso antiorario, esercitando all'inizio un momento torcente più elevato per staccare la testina.
- ▶ Ruotare il corpo di circa 3 giri completi.
- ▶ Estrarre la sonda dal foro tirando leggermente.

12. Risoluzione dei problemi durante lo smontaggio

Problema	Causa	Risoluzione
Impossibile estrarre la sonda.	Le superfici di presa del meccanismo di serraggio sono inchiodate.	<ul style="list-style-type: none"> ▶ Battere leggermente sul corpo servendosi di un martello in gomma fino a liberare le superfici di presa.

13. Manutenzione e riparazione

Manutenzione

Non è necessaria una manutenzione ordinaria.

Riparazione

Non riparare personalmente la sonda.

- ▶ Inviare la sonda danneggiata a Baumer.

14. Smaltimento



- ▶ Non gettare tra i rifiuti domestici.
- ▶ Differenziare i materiali e smaltire in base alle norme vigenti nazionali.

15. Accessori

Per gli accessori vedi www.baumer.com.

16. Dati tecnici

Condizioni ambientali

Gamma temperature di lavoro	■ -5 ... +85 °C
Gamma temperature di stoccaggio	■ -40 ... +85 °C
Umidità relativa	■ < 98%
Tipo di protezione	■ IP54

Alimentazione

Gamma tensione di alimentazione	■ 18 ... 33 V DC
Corrente assorbita	■ < 50 mA (DSRK U) ■ < 50 mA (DSRK I)

Dati elettrici

Intervallo di misura	■ 0 ... 1000 $\mu\epsilon$
Ingresso reset	■ 15 ... 45 V DC
Reset attivo	■ > ± 15 V DC
Reset inattivo	■ < ± 5 V DC
Impulso reset	■ > 1 ms

Collegamento

Spinotto di collegamento	■ Tipo Binder, serie 680/SGR 70, a 7 poli
--------------------------	---

Strain Probe DSRK

Simple strain measurement in deep holes

Strain Probe DSRK

Simple strain measurement in deep holes

Force and strain sensorst

Strain Probe DSRK

Simple strain measurement in deep holes

 **Baumer**
Passion for Sensors

Schweiz

Baumer Electric AG

P. O. Box
Hummelstrasse 17
CH-8501 Frauenfeld

Phone: +41 52 728 1122

Fax: +41 52 728 1144

Mail: sales.ch@baumer.com