



features

- flashable LED dome light
- white
- 24 V
- cable length: 0,3 m
- diameter: 130 mm
- connector and pin assignment suitable for *VeriSens*® XC series

general data

manufacturer Falcon Illumination MV GmbH & Co.KG

illumination data

color white
illumination mode flashable

mechanical data

construction design dome light
dimensions Ø 130 mm
height 61 mm
dimensions Ø external 80 mm
luminous area Ø internal 25 mm
cable length [m] 0,3 m
weight ≤ 230 g
material aluminum

electrical data

number of poles 4
illumination connector M8 connector
current ≤ 0,2 A
current at flash mode ≤ 1,25 A
voltage at flash mode ≤ 48 V
duty cycle 0-10%
maximum flash duration 10 ms

environmental conditions

operating temperature 0 ... +35 °C
humidity 20% - 85%
protection class IP 30

dimension drawing

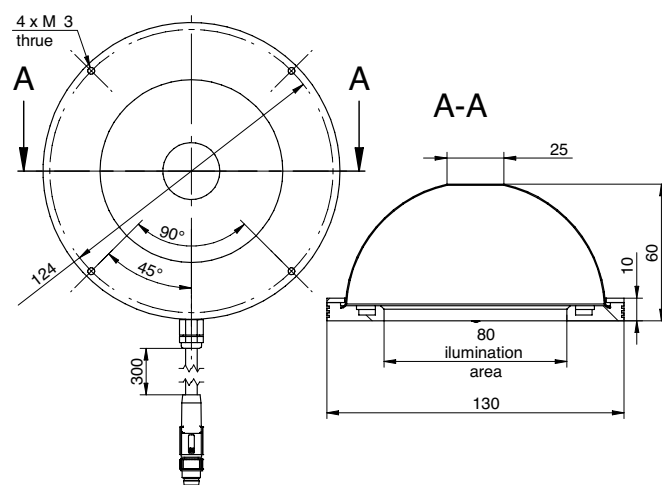

pin assignment

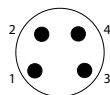

M8	signal
1:	LED +24V (pulsing 24-48 V)
2:	N.C.
3:	LED - (GND)
4:	N.C.