



features

- modular extension of the lens protection
- thread: M62
- length 6 mm

mechanical data

external diameter	65 mm
thread	M62 × 0,75
length of tube	6 mm
material	aluminum, hard-anodized
sealing	EPDM

dimension drawing

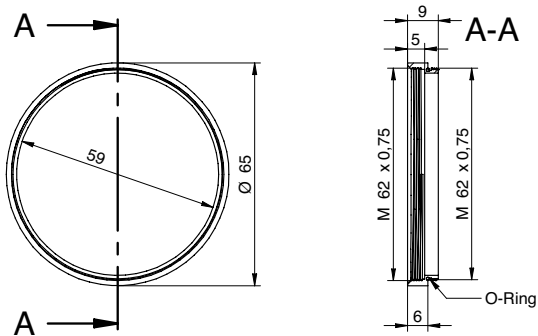

Article number: 11185376

schematic diagram

Optional accessories for protection class IP65/67:

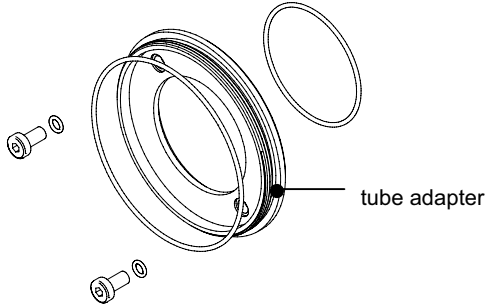

- tube adapter
- Ø 49,5 mm, hard-anodized, incl. sealing and screws (CX.I 11185373)
 - Ø 65 mm, hard-anodized, incl. sealing and screws (CX.I 11185377; VLXT 11193125)

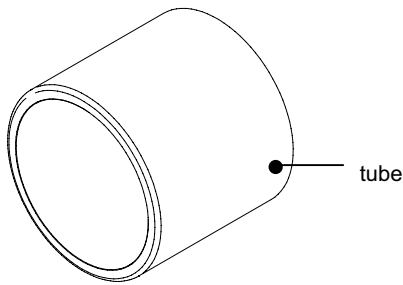

- tube
- Ø 49,5 mm, length 44 mm, hard-anodized, cover glass PMMA (11185370)
 - Ø 65 mm, length 58 mm, hard-anodized, cover glass PMMA (11185374)
 - Ø 49,5 mm, length 44 mm, hard-anodized, tempered laminated safety glass (11195425)
 - Ø 65 mm, length 58 mm, hard-anodized, tempered laminated safety glass (11195426)

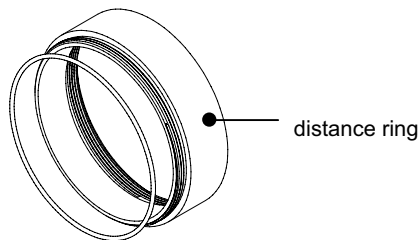

- distance ring
- Ø 49,5 mm, length 12 mm, hard-anodized, incl. sealing (11185371)
 - Ø 49,5 mm, length 6 mm, hard-anodized, incl. sealing (11185372)
 - Ø 65 mm, length 12 mm, hard-anodized, incl. sealing (11185375)
 - Ø 65 mm, length 6 mm, hard-anodized, incl. sealing (11185376)