

**Fork and angle sensors**

**FGUM 030P6901/S35A**

**dimension drawing**

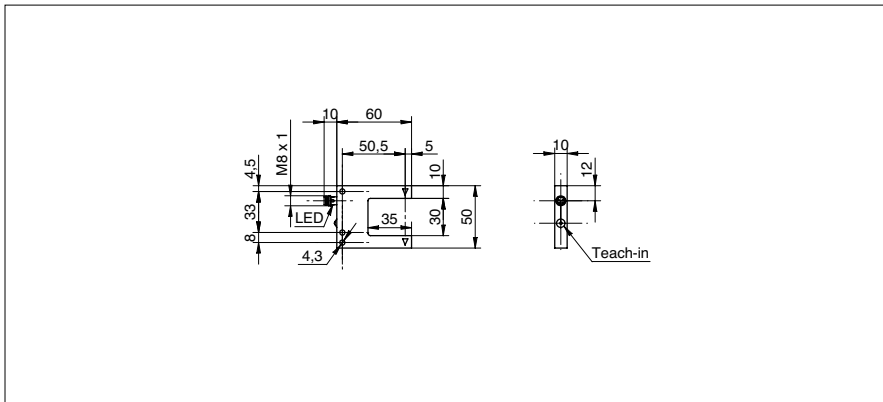

**general data**

type	through beam sensor
object size	> 0,3 mm
repeat accuracy	< 0,03 mm
hysteresis	< 0,1 mm
ambient light immunity	< 20 kLux
sensitivity adjustment	Teach-in: button / remote
light source	pulsed red LED
wave length	660 nm
light indicator	LED yellow

**electrical data**

response time / release time	< 0,166 ms
switching frequency	< 3 kHz
voltage supply range +Vs	10 ... 35 VDC
current consumption max. (no load)	30 mA
output function	light / dark operate switchable
output circuit	PNP
voltage drop Vd	< 2 VDC
output current	< 200 mA
short circuit protection	yes
reverse polarity protection	yes

**mechanical data**

width / diameter	50 mm
fork width Sb	30 mm
height / length	60 mm
penetration depth	35 mm
depth	10 mm
type	U profile
housing material	die-cast zinc
connection types	connector M8

**ambient conditions**

operating temperature	-10 ... +60 °C
protection class	IP 67

**photo**



**connection diagram**

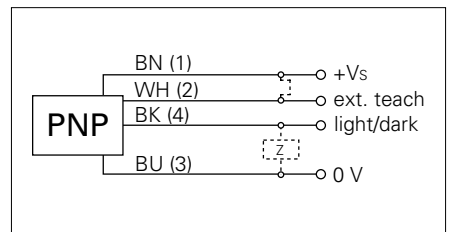

• accessories: PNP/NPN - converter