

overview

- Touch display with Live Monitor function
- Configurable switching output
- Selectable filters and trigger modes



Technical data

general data

type	distance measuring
version	OM70 laser point
measuring distance Sd	100 ... 1000 mm
measuring range Mr	900 mm
sweet spot	700 mm
adjustment	Touch Display, RS485
power on indication	LED green
output indicator	LED yellow / LED red
resolution	3 ... 63 µm
repeat accuracy	1 ... 32 µm
linearity error	± 0,19 % Mr
light source	pulsed red laser diode
wave length	660 nm
laser class	2
beam type	point
temperature drift	0,065 % So/K
hysteresis digital output	adjustable

electrical data

response delay	0,8 ms
measuring frequency	2500 Hz
voltage supply range +Vs	15 ... 28 VDC
current consumption max. (no load)	75 mA
output circuit	analog and RS 485

remarks

- Measurement with Baumer standardized measuring equipment and targets (Measurement on 90% remission (white)). Values of Resolution, linearity error and repeat accuracy apply to a measurement with filter setting (Median: 9, Average: 128).

baud rate	115200, adjustable
output signal	4 ... 20 mA / 0 ... 10 VDC
output current	< 100 mA
switching output	push-pull
short circuit protection	yes
reverse polarity protection	yes, Vs to GND

mechanical data

width / diameter	26 mm
height / length	74 mm
depth	55 mm
type	rectangular, front view
housing material	aluminum
front (optics)	glass
connection types	connector M12 8 pin
weight	130 g

ambient conditions

ambient light immunity	< 100 kLux
operating temperature	-10 ... +50 °C
protection class	IP 67
vibration (sinusoidal)	IEC 60068-2-6:2008 1 mm p-p at f = 10 - 55 Hz, duration 5 min per axis 30 min endurance at f = 55 Hz per axis
shock (semi-sinusoidal)	IEC 60068-2-27:2009 30 g / 11 ms, 6 jolts per axis and direction

dimension drawing

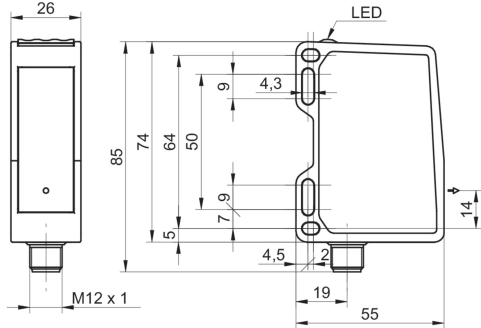

beam characteristic (typically)

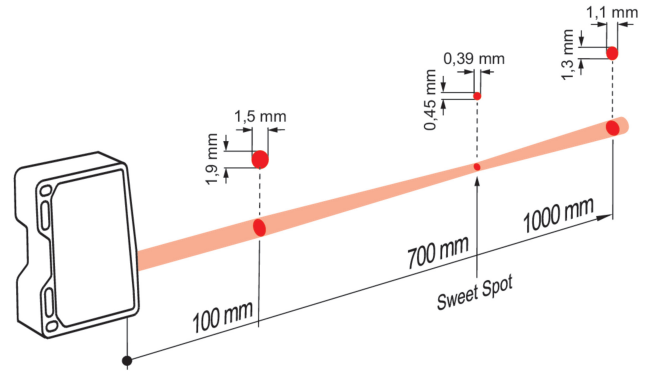

connection diagram

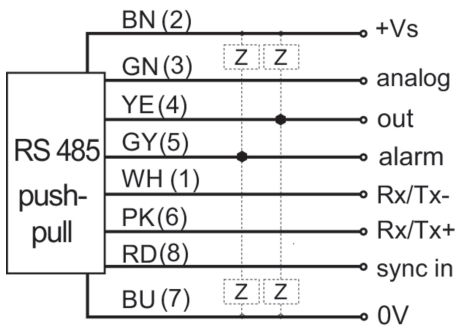

laser warning



LASER RADIATION
DO NOT STARE INTO BEAM
Wavelength: 640...670nm
IEC 60825-1, Ed. 3, 2014
CLASS 2 LASER PRODUCT

Complies with 21 CFR 1040.10 and 1040.11 except for deviations pursuant to laser notice No. 50, dated June 24, 2007

pin assignment

