

Diffuse sensors with background suppression

OHDK 25G6912

dimension drawing

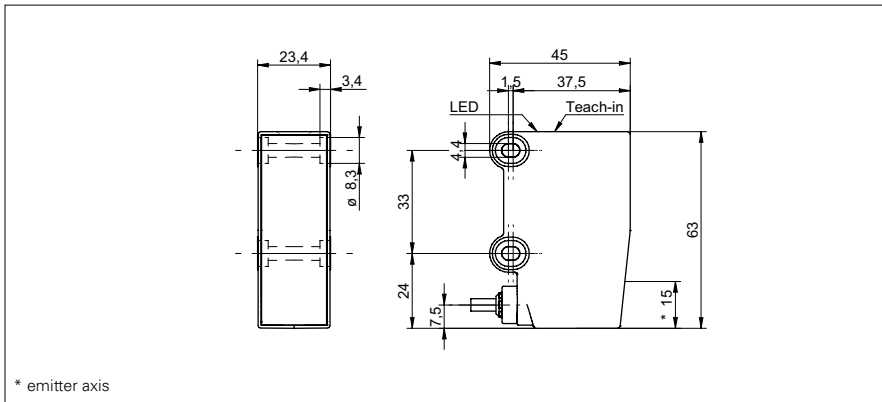

general data

type	background suppression
light source	pulsed red laser diode
sensing distance Tw	100 ... 1750 mm
sensing range Tb	100 ... 1750 mm
power on indication	LED green
light indicator	LED yellow
sensing distance adjustment	Teach-in
laser class	1
wave length	656 nm
beam diameter	3,7 ... 22 mm
black/white shift	0%

electrical data

response time / release time	< 10 ms
voltage supply range +Vs	10 ... 30 VDC
current consumption max. (no load)	80 mA
voltage drop Vd	< 3,5 VDC
output function	light / dark operate
output circuit	push-pull
output current	< 100 mA
number of outputs	2
short circuit protection	yes
reverse polarity protection	yes

mechanical data

width / diameter	23,4 mm
height / length	63 mm
depth	45 mm
type	rectangular
housing material	plastic (SAN LURAN 378P)
front (optics)	PMMA
connection types	cable, 2 m

photo



connection diagram

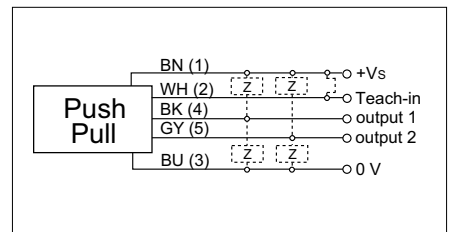

laser warning

CLASS 1 LASER PRODUCT

IEC 60825-1/2014
Complies with 21 CFR 1040.10 and 1040.11
except for deviations pursuant to laser notice No. 50, dated June 24, 2007



• qTeach

Diffuse sensors with background suppression

OHDK 25G6912**ambient conditions**

operating temperature	0 ... +50 °C
protection class	IP 67
storage temperature	-10 ... +70 °C