

Ultrasonic distance measuring sensors

UNDK 20I6912/S35A

dimension drawing

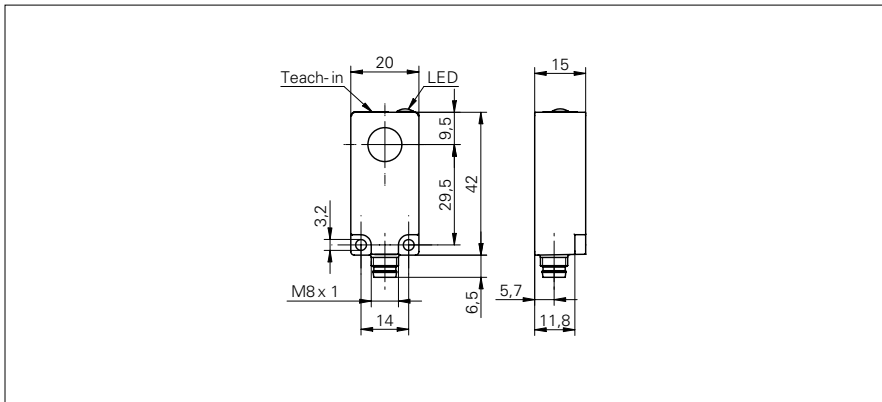

general data

scanning range Sd	60 ... 400 mm
scanning range close limit Sdc	60 ... 400 mm
scanning range far limit Sde	60 ... 400 mm
repeat accuracy	< 0,5 mm
resolution	< 0,3 mm
response time ton	< 60 ms
release time toff	< 60 ms
temperature drift	< 2 % of distance to target So
sonic frequency	290 kHz
adjustment	Teach-in
alignment aid	target indication flashing
light indicator	yellow LED / red LED

electrical data

voltage supply range +Vs	15 ... 30 VDC
current consumption max. (no load)	55 mA
output circuit	current output
output signal	4 ... 20 mA / 20 ... 4 mA
output current	< 20 mA
load resistance +Vs max.	< 1100 Ohm
load resistance +Vs min.	< 400 Ohm
residual ripple	< 10 % Vs
short circuit protection	yes
reverse polarity protection	yes

mechanical data

type	rectangular
housing material	polyester
width / diameter	20 mm
height / length	42 mm
depth	15 mm
connection types	connector M8

ambient conditions

operating temperature	-10 ... +60 °C
protection class	IP 67

photo



connection diagram

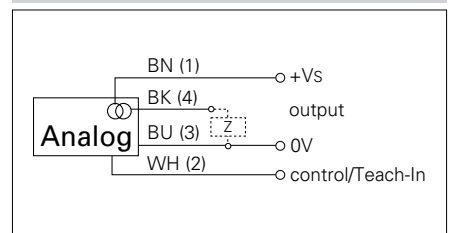

- internal and external Teach-in
- compact housing

Ultrasonic distance measuring sensors

UNDK 20I6912/S35A

typical sonic cone profile

