

Inductive sensors special versions

IFRD 12P37T3/S14

dimension drawing

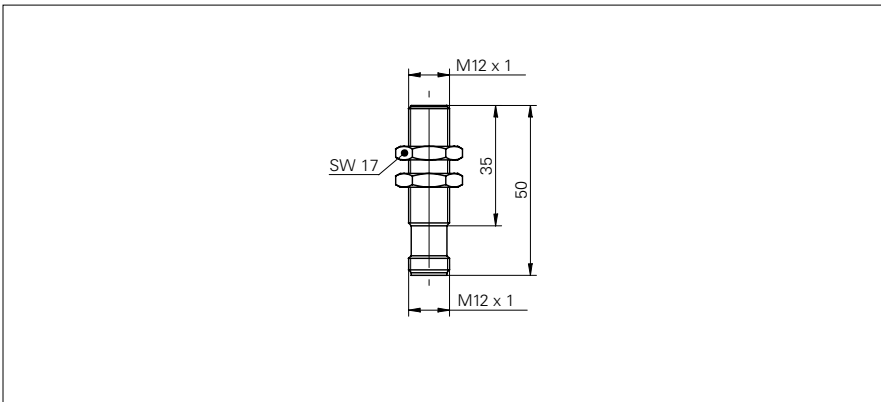

general data

mounting type	quasi-flush
special type	full metal housing (DuroProx) high temperature
nominal sensing distance S_n	4 mm
hysteresis	2 ... 20 % of S_r

electrical data

switching frequency	< 100 Hz
voltage supply range +Vs	10 ... 30 VDC
current consumption max. (no load)	14 mA
output circuit	PNP break function (NC)
voltage drop V_d	< 2 VDC
output current	< 100 mA
short circuit protection	yes
reverse polarity protection	yes

mechanical data

type	cylindrical threaded
material (sensing face)	stainless steel 1.4404 (V4A)
housing material	stainless steel 1.4404 (V4A)
operating pressure static	< 20 bar
dimension	12 mm
housing length	50 mm
connection types	connector M12

ambient conditions

operating temperature	-25 ... +100 °C
protection class	IP 69K

photo



connection diagram

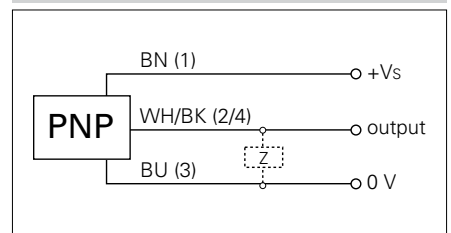

- Higher noise immunity (EMC), (EN 61000-6-2)