

Ultrasonic distance measuring sensors

UNDK 30I6103/S14

dimension drawing

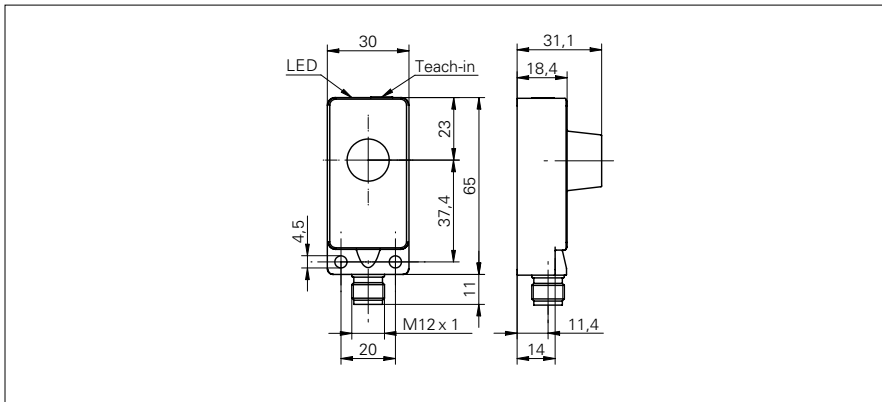

general data

scanning range Sd	100 ... 1000 mm
scanning range close limit Sdc	100 ... 1000 mm
scanning range far limit Sde	100 ... 1000 mm
repeat accuracy	< 0,5 mm
resolution	< 0,3 mm
response time ton	< 80 ms
release time toff	< 80 ms
temperature drift	< 2 % of distance to target So
sonic frequency	240 kHz
adjustment	Teach-in
alignment aid	target indication flashing
light indicator	yellow LED / red LED

electrical data

voltage supply range +Vs	15 ... 30 VDC
current consumption max. (no load)	55 mA
output circuit	current output
output signal	4 ... 20 mA / 20 ... 4 mA
output current	< 20 mA
load resistance +Vs max.	< 1100 Ohm
load resistance +Vs min.	< 400 Ohm
residual ripple	< 10 % Vs
short circuit protection	yes
reverse polarity protection	yes

mechanical data

type	rectangular
housing material	polyester / die-cast zinc
width / diameter	30 mm
height / length	65 mm
depth	31 mm
connection types	connector M12

ambient conditions

operating temperature	-10 ... +60 °C
protection class	IP 67

photo



connection diagram



- Analog current output 4-20 mA

Ultrasonic distance measuring sensors

UNDK 30I6103/S14

typical sonic cone profile

