

Ultrasonic retro-reflective sensors

URDK 20N7914/S35A

dimension drawing

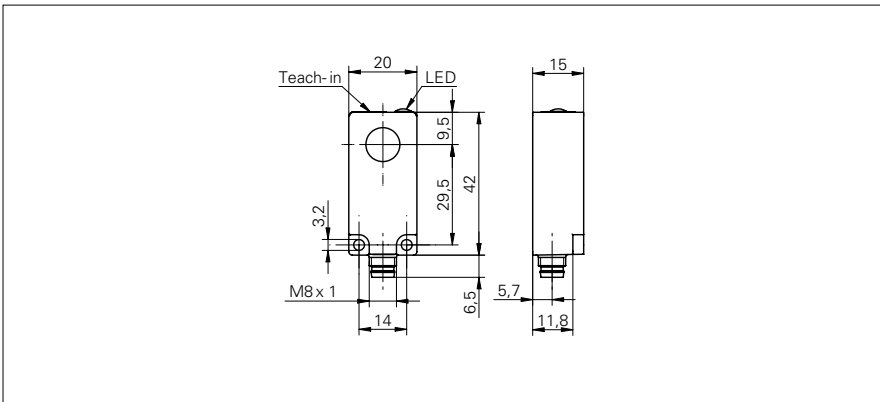

general data

scanning range Sd	0 ... 200 mm
reflector position Sde	40 ... 200 mm
adjusting range reflector (operating range)	± 2,5 % Sde
adjusting range reflector (limit range)	± 5 % Sde
repeat accuracy	< 1,5 mm
temperature drift	< 2 % Sde
response time ton	< 10 ms
release time toff	< 10 ms
sonic frequency	380 kHz
adjustment	Teach-in
alignment aid	target indication flashing
output indicator	LED green

electrical data

voltage supply range +Vs	12 ... 30 VDC
current consumption max. (no load)	35 mA
output circuit	NPN break function (NC)
output current	< 200 mA
voltage drop Vd	< 2 VDC
residual ripple	< 10 % Vs
short circuit protection	yes
reverse polarity protection	yes

mechanical data

type	rectangular
housing material	polyester
width / diameter	20 mm
height / length	42 mm
depth	15 mm
connection types	connector M8

ambient conditions

operating temperature	-10 ... +60 °C
protection class	IP 67

photo



connection diagram

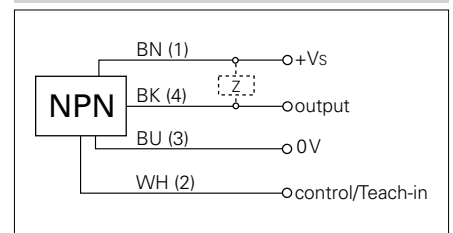

Ultrasonic retro-reflective sensors

URDK 20N7914/S35A

typical sonic cone profile

