

Diffuse sensors with background suppression

O200.GR-11212585

dimension drawing

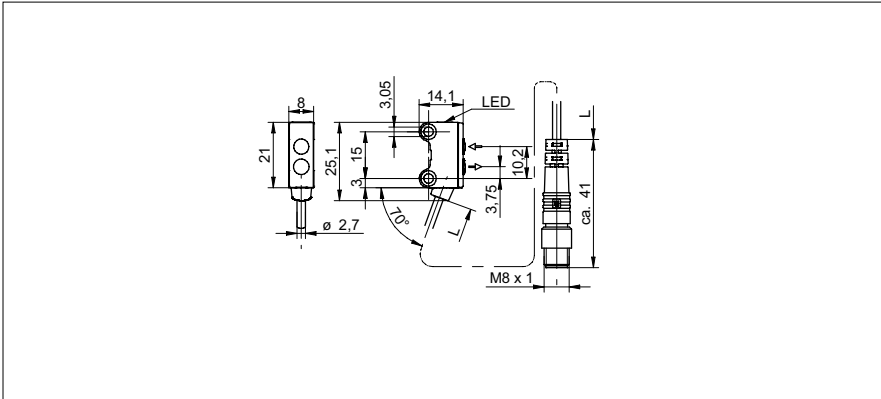

general data

type	background suppression
light source	pulsed red LED
sensing distance T_w	50 mm
sensing range T_b	7 ... 50 mm
smallest object recognizable typ.	0,25 mm at 30 mm
alignment / soiled lens indicator	flashing output indicator
power on indication	LED green
output indicator	LED yellow
sensing distance adjustment	no
wave length	644 nm
suppression of reciprocal influence	yes
alignment optical axis	< 1,5°

electrical data

response time / release time	< 1 ms
voltage supply range +Vs	10 ... 30 VDC
current consumption max. (no load)	20 mA (@ 30 VDC)
current consumption typ.	16 mA (@ 24 VDC)
voltage drop V_d	< 2 VDC
output function	light / dark operate
output circuit	PNP complementary
output current	< 50 mA
short circuit protection	yes
reverse polarity protection	yes

mechanical data

width / diameter	8 mm
height / length	25,1 mm
depth	14,1 mm
type	rectangular
mechanical mounting	sleeve smooth (stainless steel)
housing material	plastic (ASA, PMMA)
front (optics)	PMMA
connection types	flylead connector M8 4 pin, L=200 mm
cable characteristics	PVC / PVC 4 x 0,08 mm ²

photo



connection diagram

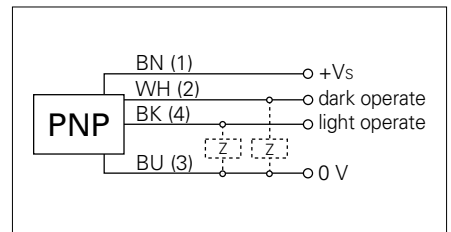

Diffuse sensors with background suppression

O200.GR-11212585

ambient conditions

operating temperature	-25 ... +50 °C
protection class	IP 67

beam characteristic (typically)

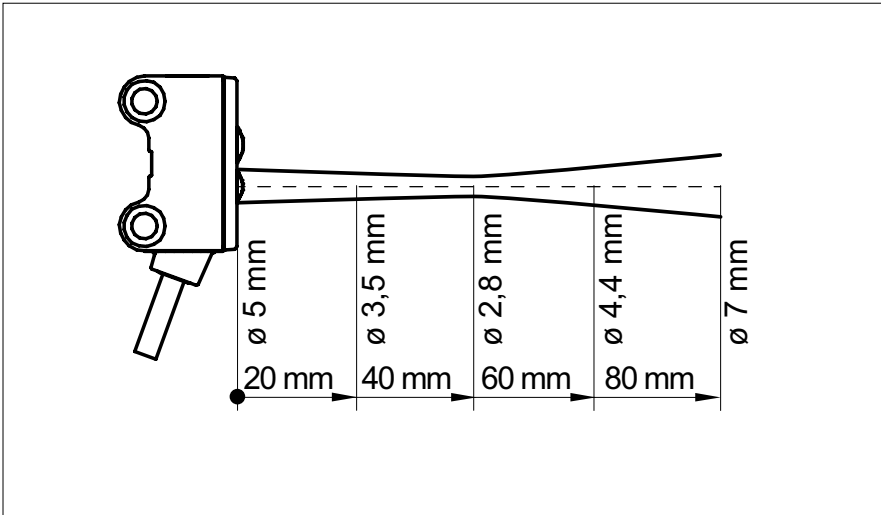

sensing distance diagram

