

OADM 20I5470/S14C

Laser Distanz Sensor

Laser distance sensor

Détecteur laser de distance



11164052



Baumer

Baumer Electric AG · CH-8501 Frauenfeld
Phone +41 (0)52 728 1122 · Fax +41 (0)52 728 1144



Abmessungen Dimensions Dimensions

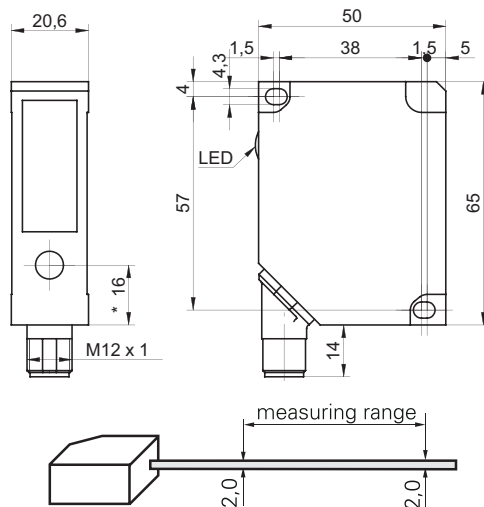

- Alle Masse in mm
- All dimensions in mm
- Toutes dimensions en mm
- * Senderachse
- * Emitter axis
- * Axe de l'émetteur

Elektrischer Anschluss Connection diagram Schéma de raccordement

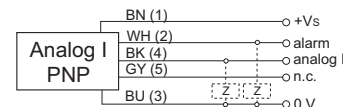

BN = Braun/brown/brun
WH = Weiss/white/blanc
BK = Schwarz/black/noir
BU = Blau/blue/bleu
GY = Grau/grey/gris

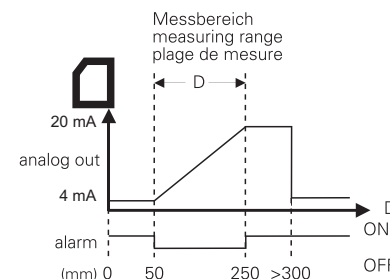
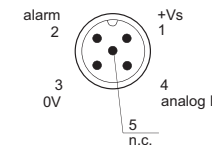

Canada
Baumer Inc.
CA-Burlington, ON L7M 4B9
Phone +1 (1)905 335-8444

Italy
Baumer Italia S.r.l.
IT-20090 Assago, MI
Phone +39 (0)2 45 70 60 65

China
Baumer (China) Co., Ltd.
CN-201612 Shanghai
Phone +86 (0)21 6768 7095

Singapore
Baumer (Singapore) Pte. Ltd.
SG-339412 Singapore
Phone +65 6396 4131

Denmark
Baumer A/S
DK-8210 Aarhus V
Phone +45 (0)8931 7611

Sweden
Baumer A/S
SE-56133 Huskvarna
Phone +46 (0)36 13 94 30

France
Baumer SAS
FR-74250 Fillinges
Phone +33 (0)450 392 466

Switzerland
Baumer Electric AG
CH-8501 Frauenfeld
Phone +41 (0)52 728 1313

Germany
Baumer GmbH
DE-61169 Friedberg
Phone +49 (0)6031 60 07 0

United Kingdom
Baumer Ltd.
GB-Watchfield, Swindon, SN6 8TZ
Phone +44 (0)1793 783 839

India
Baumer India Private Limited
IN-411038 Pune
Phone +91 20 2528 6833/34

USA
Baumer Ltd.
US-Southington, CT 06489
Phone +1 (1)860 621-2121

www.baumer.com/worldwide

Allg. Sicherheitsbestimmungen General safety instructions Instructions générales de sécurité



Laserstrahl nie auf ein Auge richten.
Es empfiehlt sich, den Strahl nicht ins Leere
laufen zu lassen, sondern mit einem matten
Blech oder Gegenstand zu stoppen.



Do not point the laser beam towards
someone's eye. It is recommended to
stop the beam by a mat object or mat
metal sheet.



Ne dirigez jamais le faisceau vers un oeil.
Il est conseillé de ne pas laisser le faisceau
se propager librement mais de l'arrêter au
moyen d'un objet de surface mate.

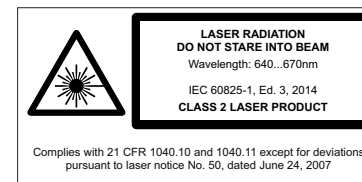

- Aus Lasersicherheitsgründen muss die Spannungsversorgung dieses Sensors abgeschaltet werden, wenn die ganze Anlage oder Maschine abgeschaltet wird.
- Laser regulations require the power of the sensor to be switched off when turning off the whole system this sensor is part of.
- Pour des raisons de sécurité, l'alimentation de ce détecteur laser doit être coupée en cas d'arrêt total du système incorporant ce détecteur.

Technische Daten
 Technical data
 Données techniques

OADM 2015470/S14C

Messbereich	Measuring range	Plage de mesure	50...250 mm
Auflösung (matt weisse Keramik)	Resolution (matte white ceramic)	Résolution (céramique blanche mate)	0,3 mm
Linearitätsabweichung (matt weisse Keramik)	Linearity error (matte white ceramic)	Déviation de linéarité (céramique blanche mate)	± 0,9 mm
Lichtquelle	Light source	Source de lumière	LASER Diode red, pulsed
Laserklasse / Wellenlänge	Laser class / Wave length	Classe laser / Longueur d'onde	2 / 650 nm
Ansprechzeit	Response time	Temps d'activation	< 10 ms
Analogausgang	Analog output	Sortie analogique	4...20 mA
Alarmausgang	Alarm output	Sortie alarme	PNP
max. Schaltstrom	max. switching current	max. courant de commutation	100 mA
Alarm / Verschmutzungsanzeige	Alarm / Soiled lens indicator	Alarme / Contrôle d'encrassement	red LED / flashing red LED
Betriebsanzeige	Power indicator	Affichage de fonctionnement	green LED
Betriebsspannungsbereich Vs (UL-Class 2)	Voltage supply range Vs (UL-Class 2)	Plage de tension Vs (UL-Class 2)	12 - 28 VDC
max. Stromverbrauch	max. supply current	max. consommation	< 120 mA
Kurzschlussfest	Short circuit protection	Protégé contre courts-circuits	ja / yes / oui
Verpolungsfest	Reverse polarity protection	Protégé contre inversion de polarité	ja / yes / oui [∇]
Arbeitstemperaturbereich	Operating temperature range	Température de service	0...50 °C
Schutzklasse	Protection class	Classe de protection	IP67

∇ Nur Betriebsspannung / voltage supply only / plage tension

Montage und Justage

Mounting Hinweis zur Elektromagnetischen Verträglichkeit:
Montage Geschirmtes Anschlusskabel empfohlen. Kabelschirm beidseitig, grossflächig erden und Potentialausgleich sicherstellen.

Note to electromagnetic compatibility:
 A shielded cable is recommended. Cable shielding on both ends, grounding over a large area and ensure potential equalization.

Note à la compatibilité électromagnétique:
 Un câble blindé est recommandé. Blindage du câble aux deux extrémités, la terre sur une grande surface et à assurer l'égalité potentiel.

Stufen
Steps
Gradins

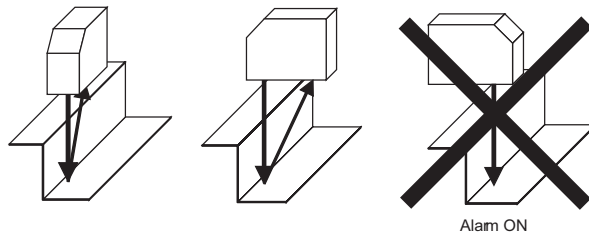

Runde, glänzende Oberflächen
Round glossy surfaces
Surfaces rondes brillantes

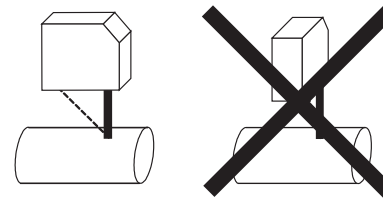

Glänzende Oberflächen
Glossy surfaces
Surfaces brillantes

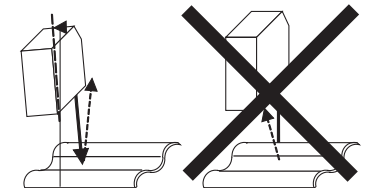

Unterschiedlich reflektierende Oberflächen
Different reflection of surfaces
Surfaces différemment réfléchissantes



Einwirkung Fremdlicht
Effect of ambient light
Influence lumière ambiante

