

## MY-COM F50/200

My-Com precision switches

Article number: 10221278

### overview

- break function (NC) mechanical
- cable, 2 m
- -20 ... 75 °C
- IP 50



### Technical data

#### general data

repeat accuracy	< 0,001 mm
activating force	50 cN
mech. pre-run / overrun	- / 1,5 mm approx.
measurement type	contact with medium
direction of approach	frontal

#### electrical data

DC voltage max.	15 VDC
switch. current DC max.	2 mA
AC voltage max.	24 VAC
switch. current AC max.	50 mA

#### electrical data

output circuit	break function (NC) mechanical
----------------	--------------------------------

#### mechanical data

activating pin	zirconium oxide ZrO <sub>2</sub>
housing material	brass nickel plated
dimension	8 mm
type	cylindrical threaded
housing length	28 mm
connection types	cable, 2 m

#### ambient conditions

operating temperature	-20 ... +75 °C
protection class	IP 50

# MY-COM F50/200

## dimension drawing

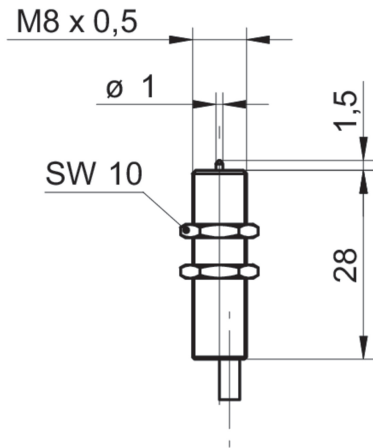

## connection diagram

