

Inductive proximity switch

IFRM 06P37A1/S35L

dimension drawing

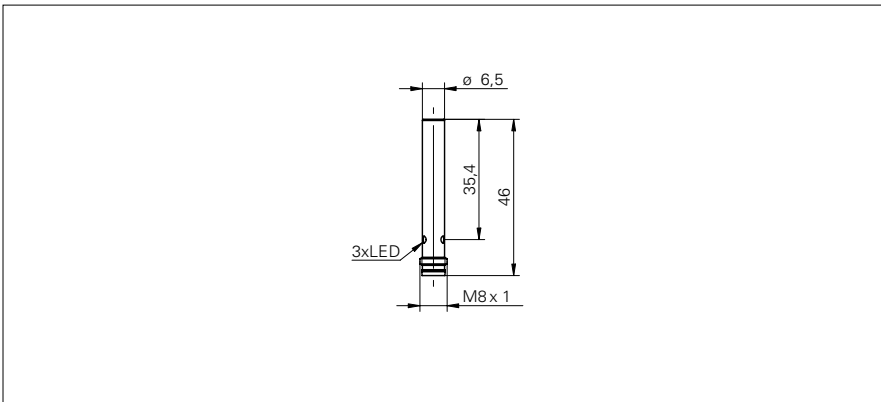

general data

mounting type	flush
nominal sensing distance S_n	2 mm
hysteresis	3 ... 20 % of S_r
output indicator	3 port LED red

electrical data

switching frequency	< 5 kHz
voltage supply range +Vs	10 ... 30 VDC
current consumption max. (no load)	12 mA
output circuit	PNP break function (NC)
voltage drop V_d	< 2 VDC
output current	< 200 mA
short circuit protection	yes
reverse polarity protection	yes

mechanical data

type	cylindrical smooth
material (sensing face)	PBT
housing material	stainless steel
dimension	6,5 mm
housing length	46 mm
connection types	connector M8

ambient conditions

operating temperature	-25 ... +75 °C
protection class	IP 67

photo



connection diagram



- robust steel housings
- high switching frequency