

Magnetic angle sensors

MDRM 18U9501

dimension drawing

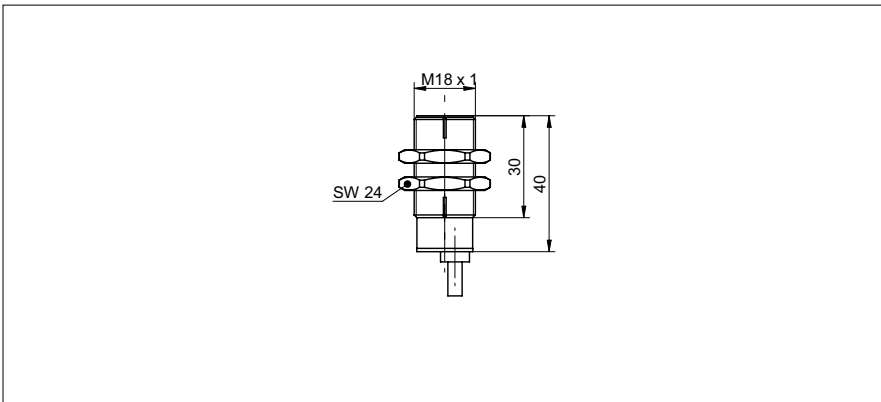

general data

angular range	160° linear
resolution	0,09 °
system accuracy	± 0,25 %
temperature drift	± 0,2 % (Full Scale)
working distance max.	5 mm, with magnet rotor MSFS
axial misalignment max.	0,4 mm

electrical data

response time	< 4 ms
voltage supply range +Vs	5 VDC
current consumption max. (no load)	10 mA
output signal	0,5 ... 4,5 VDC
load resistance	> 1000 Ohm
output circuit	voltage output
short circuit protection	yes
reverse polarity protection	no

mechanical data

connection types	cable PUR 3 x 0,25, 2 m
type	cylindrical threaded
housing material	brass nickel plated
dimension	18 mm
material (sensing face)	PBTP

ambient conditions

operating temperature	-40 ... +85 °C
protection class	IP 67

photo



connection diagram

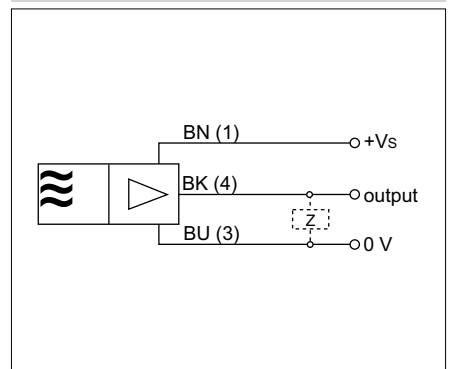

output signal

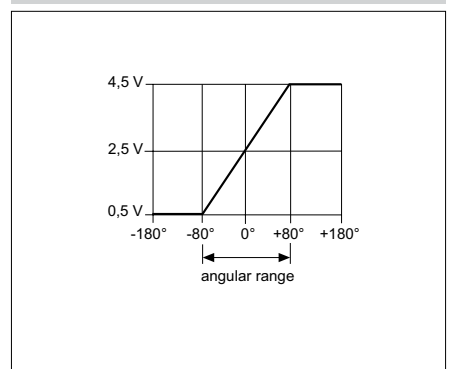

Magnetic angle sensors

MDRM 18U9501



- Rotor is available as an accessory