

Diffuse sensors fiber optics

FUL 200D2Y00

dimension drawing

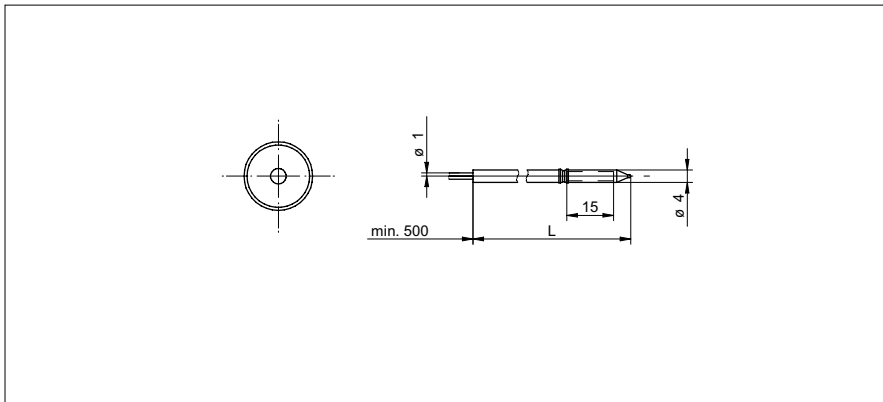

general data

type	Diffuse sensors (liquid level sensor)
measurement type	contact with medium
response time / release time	0,05 ... 5 ms
type of head (fiber optic cable)	cylindrical smooth (axial)
width / diameter (head)	4 mm
height / length (head)	15 mm
material (head)	PFA
bending radius	15 mm
cable jacket diameter	1 mm
material cable jacket	PFA (chemically resistant)
material (fiber optic cable)	plastic
length (fiber optic cable)	2000 mm
operating temperature	-30 ... +105 °C

photo



Sensing distance/response time:
For the definitive sensing distance/response time please see table below "fitting fiber optic sensors".



fitting fiber optic sensors	sensing distance Tw (0,05 ms)	sensing distance Tw (0,25 ms)	sensing distance Tw (1 ms)	sensing distance Tw (5 ms)
FVDK 67 (standard version)	-	-	-	-
FVDK 67 (2 adjustable outputs)	-	-	-	-
FVDK 67 (master/slave)	-	-	-	-
FVDK 66 (standard version)	-	-	-	-
FVDK 66 (master/slave)	-	-	-	-
FVDK 22	-	-	-	-
FVDK 12	-	-	-	-
FVDK 12 (fast version)	-	-	-	-
FVDK 10	-	-	-	-

operating modes
 HS High Speed
 FT fast
 nL Standard
 HP High Sensitivity