

USW-M | metric thread

Metal connector, safety-type, 90° elbow, metric outer thread, incl. ferrule [brass], sealing and O-ring [NBR]

Temperature: -40°C ... +125°C

Material: nickel-plated brass

Protection class [acc. to EN 60529]: IP55

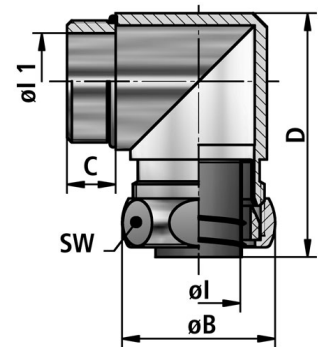

FLEXA No.	OD [mm]	Thread type	Conduit DI	Conduit OD	Ø I [mm]	Ø B [mm]	C [mm]	D [mm]	WS [mm]	Weight [kg/100]	PU [pcs.]
15010528012	10,0	M12 x 1,5	7,0	10,0	6,0	19,0	8,0	32,0	17	2,800	25
15010528016	14,0	M16 x 1,5	10,0	14,0	8,5	23,0	8,0	36,0	21	3,600	25
15010528020	17,0	M20 x 1,5	13,0	17,0	11,5	27,0	8,0	38,0	25	5,900	25
15010528025	21,0	M25 x 1,5	17,0	21,0	15,5	31,0	10,0	45,0	29	10,000	25
15010528032	27,0	M32 x 1,5	22,0	27,0	20,5	39,0	10,0	57,0	36	13,100	10
15010528040	36,0	M40 x 1,5	28,0	36,0	27,5	48,0	10,0	67,0	45	20,700	10
15010528050	45,0	M50 x 1,5	38,0	45,0	36,5	57,0	12,0	77,0	54	26,900	10
15011528063	56,0	M63 x 1,5	49,0	56,0	47,0	70,0	12,0	84,0	66	32,400	2

Recommendations for any areas of applications, products, or product combinations are issued to the best of FLEXA's knowledge and experience. The user is requested to check applicability of FLEXA products to specific applications and purposes prior to the use of the particular products. All documentation, illustrations, and charts published are subject to copyright and must not be copied, changed, used, or modified. Technical drawings, certificates, authorizations, and results by the FLEXA lab will be provided upon request. FLEXA will not be held liable for typographical or other errors and incorrect drawings. Technical modifications are subject to change without prior notice.