

OPERATING INSTRUCTIONS

Safety-Light-Barrier-Amplifier

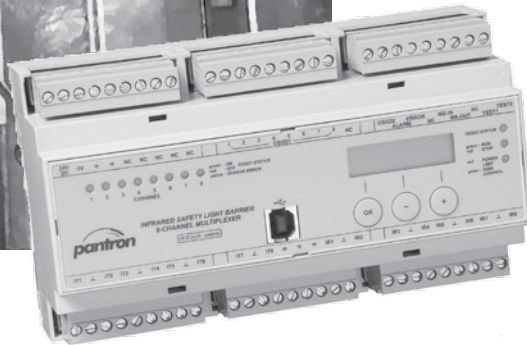

ISL-8000



Safety-Light-Barrier-Amplifier ISL-8000

Operating instructions (English translation)

State of the art: 19.05.2016

This Manual refers to devices manufactured since May 2016
(Ref. 01/04).

1	Introduction	6
1.1	System description	6
1.2	Intended use	6
1.3	Delivery contents	6
1.4	Used symbols	6
1.5	Safety regulations	7
2	Product description	8
2.1	Abstract.....	8
2.2	Testing	8
2.2.1	Internal testing	8
2.2.2	External testing.....	8
2.3	Range of detection.....	8
2.4	Start-up / restart prevention (RES)	8
2.5	Device overview.....	9
2.6	Indicating elements.....	9
2.6.1	Channel status indication OSSD1 STATUS	9
2.6.2	System status indication	10
2.6.3	Display	10
2.7	Control elements.....	10
2.8	USB interface.....	11
3	Mounting	11
3.1	Safety-light-barrier-amplifier	11
3.1.1	Mechanical mounting.....	11
3.2	Safety sensors	11
3.2.1	Safety clearance	12
3.2.2	Minimum clearance to reflecting surfaces	12
3.2.3	Mounting advice.....	13
3.2.4	Mechanical mounting.....	13
4	Electrical connection	14
4.1	Wiring diagram.....	14
4.2	Supply voltage	14
4.3	Grounding (⏏)	15
4.4	Sensors.....	15
4.4.1	Transmitter (IT)	15
4.4.2	Receiver (IR).....	15
4.5	Safety outputs.....	15
4.5.1	OSSD1.....	15
4.5.2	OSSD2.....	16
4.6	Functional outputs	16
4.6.1	Alarm output (ALARM).....	16
4.6.2	Error output (ERROR)	16
4.7	Test inputs.....	16
4.7.1	Testing input 1 (TEST1).....	16
4.7.2	Testing input 2 (TEST2).....	16
4.8	Master-Slave (MS-IN/MS-OUT).....	16

5	Setting into operation	17
5.1	Lichtschrankenverstärker in Betrieb nehmen	17
5.2	Adapt light-barriers	18
5.3	Align sensors	19
5.4	Finishing installation	21
5.4.1	Testing the channel assignment	21
5.4.2	Testing detectability	21
5.4.3	Testing the testing inputs	21
6	Handling	22
6.1	Light-barrier-mode (run mode).....	22
6.2	Displaying information	22
6.2.1	Displaying light path information.....	22
6.2.2	Software revision and date of construction.....	23
6.2.3	Serial number	23
6.3	Light-barrier setup.....	23
6.3.1	Entering PIN code.....	24
6.3.2	Switching light-barrier channels on or off.....	24
6.3.3	Changing device settings.....	25
6.3.3.1	Activating / deactivating the cumulative output.....	25
6.3.3.2	Changing LCD contrast	26
6.3.3.3	Changing the polarity of the testing inputs.....	26
6.3.4	Aligning sensors / Analyzing sensor failure / Verifying testing inputs	27
6.3.4.1	Aligning the light-barrier.....	27
6.3.4.2	Analyzing sensor failure.....	28
6.3.4.3	Validating the testing input.....	28
6.3.5	Reset transmit power.....	28
6.3.6	Restoring factory settings	29
7	Error indication.....	30
7.1	Error classification	30
7.2	Power limit	30
7.3	Sensor failure.....	31
7.4	External Error.....	31
7.5	Internal error	32
7.6	Program execution error	32
8	Regular inspection	32
9	Maintenance.....	33
10	Technical Data	34
11	Dimensioned drawing	35
12	Type table	35
13	Appendix	36
13.1	EU-Declaration of conformity.....	36
13.2	Identity Card	37

1 Introduction

1.1 System description

The Safety-Light-Barrier-Amplifier ISL-8000, in conjunction with optical safety-transmitters and safety-receivers, yields a contactless protective device (BWS) according to EN 61496 Part 1 and Part 2.

1.2 Intended use

The Safety-Light-Barrier-Amplifier is used for personal protection in restricted areas near machines and plants. Combined with optical safety-sensors (transmitter and receiver) it forms as safety one-way light-barrier. Sensors are installed in a fixed position at the entrance to the restricted area and connected to the safety-light-barrier-amplifier. The amplifier detects any interruption of a light-barrier route and reports the event at the assigned safety-output.

Operation of the amplifier is only valid according to its technical specification. Any other use of the device as well as any modification of amplifier and/or sensors is prohibited.

1.3 Delivery contents

- Safety-light-barrier-amplifier
- Operating instructions
- Test specimen

1.4 Used symbols

Throughout this manual information of interest is highlighted by symbols.



This symbol indicates optional display or choice, whereby multiple selections are possible



Tip!

This symbol indicates explanations or annotations regarding special features of the safety-light-amplifier.



Attention!

This symbol indicates **very** important information or possible hazard. Please read information with care and act accordingly.

1.5 Safety regulations



Hazard!

The safety function may be affected if the device is used improperly or outside its technical specification. Disregarding the safety regulations may lead to serious injury or even death.

- The designer or operator of the overall system (e.g. a machine or plant) is responsible for applying all national or international safety and accident prevention regulations.
- Assembly and electrical wiring of the safety-light-barrier-amplifier is to be done only by skilled personnel according to applicable regulations.
- Assembly and electrical wiring of the safety-light-barrier-amplifier is to be done with target system switched off and power supply disconnected. The target system is to be secured against accidental activation.
- Access or entry to the restricted area may only be possible via a safety clearance.
- The target system needs to be electrically controllable.
- Hazardous movement must come to a halt before reaching the restricted area.
- Examination and documentation is to be done by skilled personnel only or by authorized and trained personnel respectively.
- This manual must be added to the documentation of the superior system (machine or plant) into which the protectional device (safety-light-barrier-amplifier) is integrated. The manual must be available throughout the entire period of use by all personnel engaged in construction, implementation, operation and maintenance. The legal operator must ensure that the operator on duty is instructed by skilled personnel.
- The safety-light-barrier-amplifier is not to be utilized as a light curtain in terms of EN 61496 part 2.
- Operation in dense fog or water vapor is likely to reduce the range of detection which applies to an object size not smaller than 10 mm.
- Additional measures may be taken to ensure failure-free operation. Attention as to be focused on special applications using different forms of light emission, e.g. optical data transmission systems, stroboscope lights, different optical safety equipment.
- Used in systems dealing with food, cosmetics or pharmaceuticals where applicable sensor types and material (plastics, stainless steel) must be utilized.

2 Product description

2.1 Abstract

The safety-light-barrier-amplifier ISL-8000... in conjunction with an optical safety -transmitter IST-... and an optical safety-receiver ISR-... forms a powerful light barrier whereby up to eight independent light barrier routes may be realized without mutual interference.

The amplifier evaluates each single light-barrier route and reports the status , interrupted or clear, via the output OSSD1 to the superior control system. Every light-barrier route has a separate output. The integrity of the connection to the control system may be evaluated by using internal or external testing (see chapter **2.2 Testing**).

To reduce service effort and to equalize changing environmental conditions (e.g. sensor contamination), the transmit-power of every individual channel is constantly adjusted by the automatic power regulation. When the transmit power of a channel reaches 90% of maximum transmit power, this condition is reported by a alarm indicator and by activating the alarm output.

Via an integrated USB-Interface the device may be conveniently be programmed and controlled by a PC for servicing purposes. (Software optionally available).

2.2 Testing

2.2.1 Internal testing

During normal operation, continuously periodical self tests are executed. Both, the switching outputs OSSD1 and the safety-output OSSD2 must be connected to the superior control system and must be evaluated independently. In case of an error, both outputs will switch off.

2.2.2 External testing

In case evaluating safety -output OSSD2 is not possible, external testing must be executed. To do this, test-input 1 must be stimulated periodically by a test signal causing a reaction at the outputs OSSD1. For more information, refer to **4.7 Test inputs**.

2.3 Range of detection

The system is able to detect a transparent cylindrical test specimen with a diameter of 10 mm, which may be placed arbitrarily on the centerline between transmitter and receiver. The response time is at most 36 ms.

2.4 Start-up / restart prevention (RES)



Attention!

The safety-light-barrier-amplifier does **not** employ start-up / restart prevention capability. As soon as a light-barrier-trace gains clear view, its assigned output OSSD1 will switch on. If restart prevention is necessary, it must be implemented by the superior control system.

2.5 Device overview

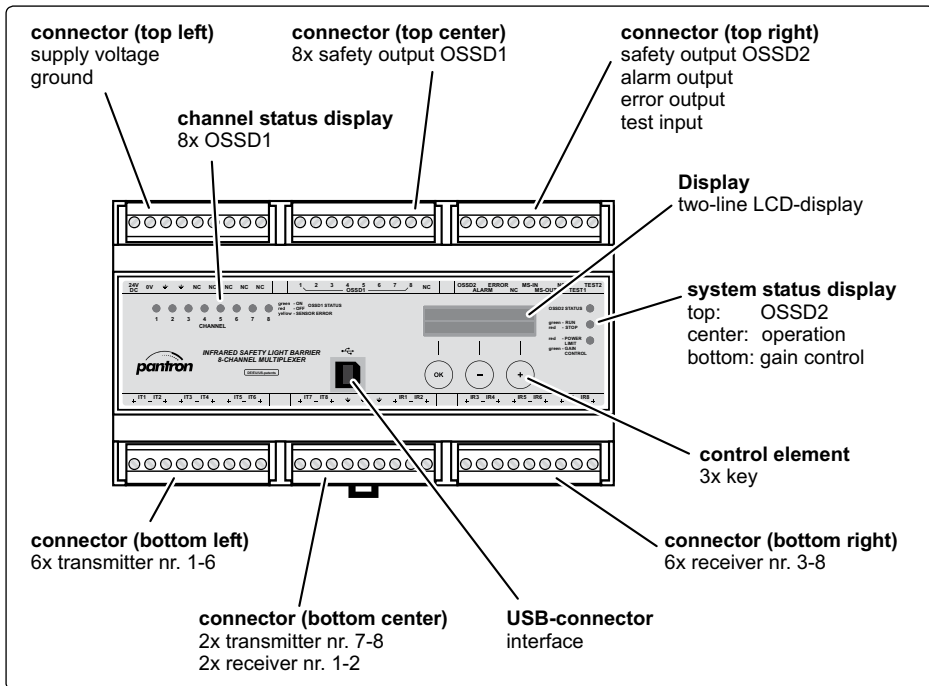

figure 1: Layout of terminals, displays and controls

2.6 Indicating elements

Refer to **figure 1** to locate indicating elements.

2.6.1 Channel status indication OSSD1 STATUS

Every channel has its own assigned status indication. The status is indicated by a multi color LED. Refer to **table 1** to learn about the coding of the channel status indication.

Color	Meaning
green	OSSD1 "ON" The switching output of the assigned channel is active. The light-barrier-route in question has clear view.
red	OSSD1 "OFF" The switching output of the assigned channel is inactive. The light-barrier-route in question is obstructed.
yellow	SENSOR ERROR Receiver or transmitter fault has been detected.

table 1: Coding of channel status indication

2.6.2 System status indication

To indicate various system states, the device has three multi-color LEDs. Refer to **table 2** below to learn about the coding of indication

LED	Color	Meaning
OSSD2 (top)	green	ON The switching output is active. The device works error-free.
	rot flashing	OFF The switching output is inactive. The device reports an error. For more information refer to 7.5
	red continuous	Program STOP The safety output is inactive. The device reports an program error. For more information refer to 7.6 .
Operation (center)	green	RUN mode The light-barrier-function is working error-free.
	red	STOP mode The light-barrier-function has stopped working, e.g. for programming mode.
Gain control (bottom)	green	Regulation Regulation is active for all channels.
	red	Power limit Transmit power of at least one channel has reached the power limit. For more information refer to 7.2 .

table 2: Meaning of "system status" LEDs

2.6.3 Display

Via the LCD display, all information about the menu-driven user guidance will be displayed. For more information refer to chapter **6 Handling**.

2.7 Control elements

By means of three pushbutton navigation through menus, entering of values / parameters is accomplished. There are two levels of button layout. While navigating through menus, the "soft key" assignment is valid, meaning the corresponding function will be displayed right above the pushbutton. If a value is changed or a parameter is selected, the caption of the pushbutton on the second row of display is valid. Refer to **table 3** for more information.



Button	Meaning
	Navigation through menu or confirmation of changes.
	Navigation through menu or increasing of values.
	Navigation through menu or decreasing of values.

table 3: Meaning of control elements

2.8 USB interface

For servicing purposes a USB interface (Universal Serial Bus) is provided. Using software application *Win/SL*, the device may be programmed. Moreover various diagnostic functions may be accessed



Attention!

The USB interface is not subject to constant safety surveillance and therefore **must not** be used as safety output!

3 Mounting

3.1 Safety-light-barrier-amplifier

The safety-light-barrier-amplifier has enclosure type IP20 and is meant to be located in an electric cabinet or protective housing with enclosure type not less than IP54. The amplifier is to be mounted on a DIN rail NS35/7,5 resp. NS35/15 according to EN 60715. Assembly must be performed in such a manner that indicating elements of the device remain visible.

Nearby devices that radiate heat must be placed with a clearance not less than 20 mm away from the safety-light-barrier-amplifier. For electrical wiring a clearance of at least 15 mm top and bottom must be provided.

3.1.1 Mechanical mounting

- The assembly must be performed in such a manner that no additional hazard will be introduced.
- Access to the safety-light-barrier-amplifier must be safely possible.
- The safety-light-barrier-amplifier must not be placed within the restricted area. Sufficient safety clearance must be provided.
- The safety-light-barrier-amplifier must be firmly mounted such that it is secured against falling off or accidental change of position.
- If the safety-light-barrier-amplifier's power supply is separated by removing the connector, provisions must be made that the permanent separation may be monitored from every access point of the restricted area.

3.2 Safety sensors



Attention!

Using sensors without approval for use with safety-light-barrier-amplifiers leads to loss of the protective function. Only approved safety sensors may be used.

Mounting of safety sensors depends in accordance with DIN EN ISO 13857 resp. EN 999 on the type of protection:

- Hazardous spot protection
- Restricted area protection
- Access protection

For detailed information on safety distance, mounting heights, beam distance and resolution, refer to standards DIN EN ISO 13857 and EN 999.

3.2.1 Safety clearance

The light-barrier and the restricted area must be separated by a safety clearance. This clearance must be wide enough that in case of a breach, it is impossible to reach the restricted area until the danger inducing motion has come to a halt.

The safety clearance depends on:

- Follow-up time of the machine (stop-time)
- Reaction time of the protective equipment
- Resolution of the protective equipment
- Approximate speed towards the restricted area
- Arrangement of protective elements

According to standard EN 999 the safety clearance width S for access or restricted area protection is determined by the equation:

$$S \text{ [mm]} = K \text{ [mm/s]} \times T \text{ [s]} + C \text{ [mm]}$$

S = Safety clearance width in mm

K = Approximation speed in mm/s

T = Overall delay time measured in seconds

= reaction time of the protective equipment + reaction time of the superior control system + follow-up time of the machine

C = safety margin depending on penetration depth into safety clearance until safety-light-barrier-amplifier reacts

For detailed information, refer to standard EN 999.

3.2.2 Minimum clearance to reflecting surfaces

Considering aperture angles, reflecting surface in vicinity to the optical path may lead to beam deflection which, in turn, may cause an obstacle to be disregarded. Refer to **figure 2**.

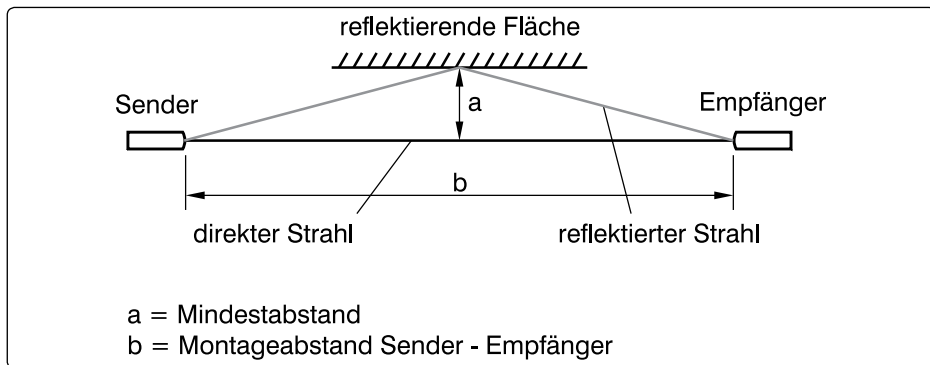

figure 2: Deflection on reflecting surfaces

The minimum distance “a” (distance of beam core center line to a reflecting surface) depends on the distance “b” between the transmitter and receiver and is calculated as follows:

$$a = \tan 5^\circ \cdot \frac{b}{2} \approx 0,045 \cdot b$$

Example:

If the distance between transmitter and receive is 10 m, the minimum clearance will result in:

$$a = 0,045 \cdot 10 \text{ m} = 0,45 \text{ m}$$

3.2.3 Mounting advice

Please mind the advice below when mounting sensors:

- According to the technical specification, please validate if the sensors suit your application (also read "Safety sensor guide").
- Please verify that it is impossible to reach below, above or around the safety area as well as to step around it.
- Position the light barrier in a distance not less than the minimum safety clearance in respect to the restricted area (refer to **3.2.1 Safety clearance**)
- Observe the minimum clearance to reflective surfaces (refer to **3.2.2**)
- Keep in mind, that an object needs to be equal or larger than the specified detection capability of the light barrier.
- Do not exceed the specified distance between transmitter and receiver, as specified in chapter **10 Technical Data**.

3.2.4 Mechanical mounting

The type of mounting depends on the form factor of the individual sensor (refer to the dimensional drawing in "Safety sensor guide". Please follow this advice when mounting sensors:

- Sensors may only be mounted to solid, non-vibrating components.
- Once adjusted, sensors may not be accidentally displaced.
- Disassembly may only be possible using tools.

4 Electrical connection



Hazard!

There is the risk of the machine starting up during the process of electrical installation. To counteract this, disconnect the power supply and secure against reactivation. Only after all protective functions of the safety equipment have been tested, may it be integrated into the safety circuit of the machine.

4.1 Wiring diagram

The light-barrier-amplifier has six pluggable nine-way screw terminals. The layout is shown in **figure 3**.

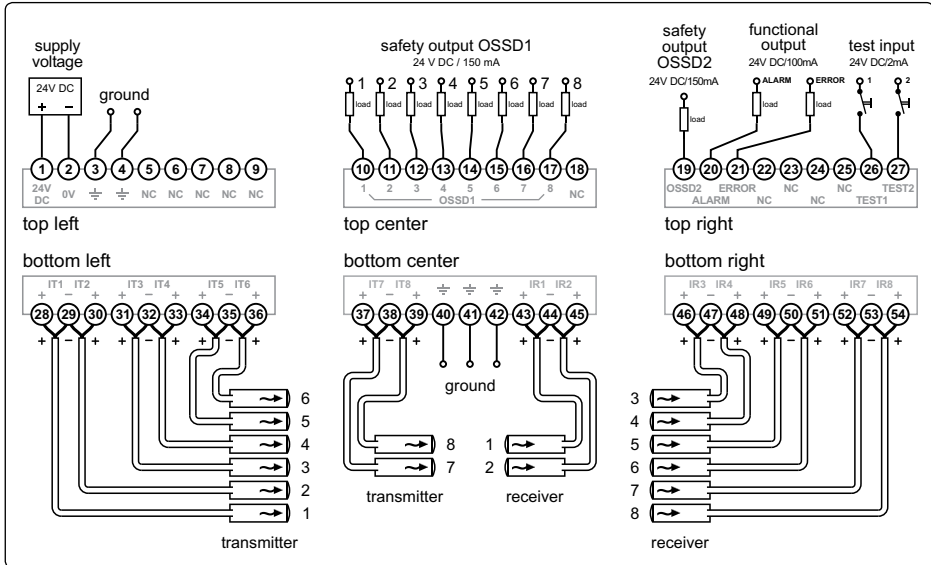

figure 3: Wiring diagram

4.2 Supply voltage

The device accepts a 24 V supply voltage with a tolerance of 20 % each way. The voltage range is mandatory because the device permanently monitors the supply voltage and in case of exceedance, enters the locked state.

The power supply must generate a protective extra-low voltage (Class 2 Power Supply) and comply with requirements according to standard EN 60204-1. In particular, the power supply must be capable of sustaining 20 ms of ac line failure.

The device does not have internal fusing. To prevent damage in case of a short circuit an external fuse must be installed (class B 2 A automatic circuit breaker, 2 A semi time-lag fuse, selectivity module set to 2 A). The power supply must have the capacity to trigger the fuse in case of a fault condition.

4.3 Grounding (\cong)

To comply with EMC regulations, earth ground must be connected (upper row: terminal 3 or 4, lower row: terminal 40, 41 or 42). The connection to the cabinet must be done via a low impedance cable using the shortest possible route.

4.4 Sensors

4.4.1 Transmitter (IT)

The transmitter terminals are short circuit protected. Transmitter 1/2, 3/4, 5/6 and 7/8 share a common return path (-) terminal each.

**Tip**

The return paths of all transmitters may be combined to a single common bus line connected to one of the transmitter “-” terminals. They may not be connected to ground or any other potential.

4.4.2 Receiver (IR)

The receiver terminals are short circuit protected. Receiver 1/2, 3/4, 5/6 and 7/8 share a common return path (-) terminal each.

**Tip**

The return paths of all receivers may be combined to a single common shielded bus line connected to one of the receiver “-” terminals. They may not be connected to ground or any other potential.

4.5 Safety outputs

The safety outputs are protected against short circuit and overload. The outputs are continuously, internally tested causing short-term level change in output signals, which must be ignored by the superior control system.

The test pulses are only present while the output is in high state and have a pulse width of 100 μ s. The maximum load-current is 100 mA at 24 V dc.

**Attention!**

The safety outputs may not be connected to external pull up resistors. The superior control system has to be designed in a way to ensure low potential at the safety output in case of a wire break.

4.5.1 OSSD1

The safety output OSSD1 reports the status of the assigned light-barrier channel to the superior control system. In case of an unobstructed light path between transmitter and receiver, the output will be in high-state (24 V dc). In the presence of an obstacle, the output will be in low-state (0 V). The minimum low-time is 30 ms.

4.5.2 OSSD2

In case the light-barrier-amplifier is operated without external testing, the safety output OSSD2 must be connected to the superior control system and analyzed independently of OSSD1. During fault-free condition, safety output OSSD2 is in high state (24 V dc). In occurrence of an error, OSSD2 switches to low-state (0 V).

4.6 Functional outputs



Attention!

Functional outputs are not (internally) tested and do not provide a protective function. These outputs may not be used as safety outputs.

Functional outputs provide additional information on the condition of the light-barrier-amplifier. Permissible load-current is 100 mA at 24 V dc.

4.6.1 Alarm output (ALARM)

The alarm output reports to the superior control system that at least one light-barrier channel has reached its power limit.

4.6.2 Error output (ERROR)

The error output reports to the superior control system that at least one light-barrier sensor is in fault condition

4.7 Test inputs

4.7.1 Testing input 1 (TEST1)

If the light-barrier-amplifier is operated with external testing, input TEST1 must periodically be driven by a test signal and the subsequent reaction of the outputs OSSD1 must be analyzed. Input TEST1 is stimulated with voltage levels of 24 V dc (high) or 0 V (low).

As a reaction to the testing signal the outputs OSSD1 are switched off if the device is working error-free. By removing the test signal, the outputs OSSD1 return to the normal states according to the status of the light-barrier routes. The delay time does not exceed 10 ms both ways. The test signal is supposed to have a pulse with not less than 29 ms and a dead time of at least 20 ms.



Tip

The polarity of the testing signal may be inverted. The device must be programmed accordingly. Refer to 6.3.3.3 for more information.

4.7.2 Testing input 2 (TEST2)

At present, no function is assigned to testing input TEST2.

4.8 Master-Slave (MS-IN/MS-OUT)

Die Master-Slave Anschlüsse haben in der aktuellen Version keine Funktion.

5 Setting into operation



Hazard!

There is the risk of the machine starting up during the process of setting into operation. To counteract this, disconnect the power supply and secure against reactivation. Only after all protective functions of the safety equipment have been tested, may it be integrated into the safety circuit of the machine.

5.1 Lichtschrankenverstärker in Betrieb nehmen

5.1 a Prior to putting the amplifier into action, please check...

- power supply voltage level
- the wiring
- the light-barrier to be unobstructed

5.1 b putting the amplifier into action

- After switching on the power supply, the light-barrier-amplifier commences a self-test routine
- Look at the reading in the first line of the display

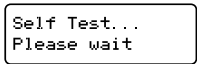

→ "ISL-8000" is displayed

- The amplifier is wired correctly. Proceed to **5.2**.

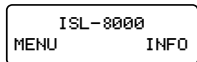

→ "SENSOR FAILURE" is displayed

- Determine which channel status indicator is illuminated yellow.

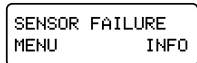

- This channel is intentionally left unconnected (no sensors). Proceed to **5.2**.

→ **Sensors are connected to that channel.**

- The amplifier is wired incorrectly. Switch off power supply and review the installation. Detailed information about the electrical installation is provided in Chapter **4 Electrical connection**. Resume setting up from the beginning.

5.2 Adapt light-barriers

To guarantee correct functioning of the light-barrier-amplifier, each light-barrier channel has to be adapted to its given environmental conditions. The actual light-barrier function is interrupted while programming (stop mode, system status indicator “operation” illuminates red). The performance of each light-barrier may fundamentally be changed. To avoid unintended change of settings the sequencing steps are protected by PIN, refer to chapter **13.2 Identity Card**.

5.2a Invoking programming mode and entering PIN

- Press **OK** to enter programming mode.

```

Enter PIN: 0000
OK   NEXT  SET
    
```

Two steps to enter the PIN:

- Press **+** to choose the number.
- Press **-** to choose the digit.

As soon as PIN is entered completely,

- Confirm PIN number by pressing **OK**.

→ The text “**SYSTEM SETTINGS**” is displayed.

- The PIN has been entered correctly. Proceed to **5.2b**.

```

SYSTEM SETTINGS
OK   EXIT  -->
    
```

→ The text “**ISL-8000**” is displayed.

- The PIN has been entered incorrectly. Return to **5.2a** fort.

```

      ISL-8000
MENU          INFO
    
```

5.2b Change to the channel settings menu

→ The text “**CHANNEL SETTINGS**” is displayed.

- Confirm selection by pressing **OK**

```

CHANNEL SETTINGS
OK   EXIT  -->
    
```

→ The text “**CHANNEL SETTINGS**” is not displayed.

- Repeatedly press **+** until “**CHANNEL SETTINGS**” is displayed.
- Confirm selection by pressing **OK**

5.2c Select a light-barrier channel

- Repeatedly press **+** until the desired channel is selected.
- Confirm selection by pressing **OK**

```

SELECT CH. > 1
OK   EXIT  +
    
```

5.2d Select mode of operation

The mode of operation defines how the transmit power is adapted to meet the environmental conditions. You may choose:

- | | |
|----------------|---|
| Channel off | - The transmitter is switched off. You have to switch off all channels with no sensors connected. |
| Automatic mode | - Transmit power is automatically adapted according to the given environmental conditions. |

➔ **Switch off a channel**

- Repeatedly press \oplus or \ominus until "OFF" is tagged.
- Confirm selection by pressing OK
- Setting of this channel is done. Proceed to **5.2e**.



➔ **Automatic mode**

The power range must be chosen. It defines the reaction to sudden interruption of the light path e.g. in case of fast pollution of a sensor. The interruption has to be low enough to stop the automatic power regulation but not to interrupt the light-barrier entirely (regulation indicator off, channel status indicator green).

- A1 - Little interruption is necessary to switch off the light-barrier (high sensitivity). Transmit power regulation is stopped.
- A2 - A higher interruption is necessary to switch off the light-barrier (low sensitivity). Transmit power regulation is stopped.
- A3 - Little interruption is necessary to switch off the light-barrier (high sensitivity). Transmit power regulation is stopped for 30 seconds. Next, the transmit power is increased until the original switch-off sensitivity is reached again.
- A4 - A higher interruption is necessary to switch off the light-barrier (low sensitivity). Transmit power regulation is stopped for 30 seconds. Next, the transmit power is increased until the original switch-off sensitivity is reached again.

1. Choosing automatic mode

- Repeatedly press \oplus or \ominus until "AUTO" is tagged.
- Confirm selection by pressing OK



2. Choosing power range

- Repeatedly press \oplus or \ominus until the desired power range is tagged.
- Confirm selection by pressing OK

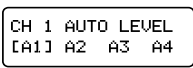

5.2e Completing the channel setting

➔ **Setting of the current channel is complete**

- Proceed to **5.2c** to continue with another channel

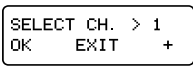

➔ **Setting of all channels is complete**

- Press \ominus once to exit the channel settings menu



5.3 Align sensors

Alignment of sensors has to be done for every channel.



Attention!

For sensor alignment, shut down the machine and secure against reactivation if sensors are located within the restricted area.



Tip

Verification of wiring as well as alignment of sensors may also be accomplished via optionally available software.

5.3a Activating programming mode and entering the PIN

This item only has to be carried out if programming mode has been left. Otherwise, proceed to item **5.3b**.

- Press **OK** to enter programming mode



Two steps to enter the PIN:

- Press **+** to choose the number.
- Press **-** to choose the digit.

As soon as PIN is entered completely, ist...

- Confirm PIN number by pressing **OK**.

→ The text **“CHANNEL SETTINGS”** is displayed..

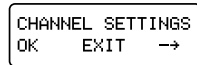

- The PIN has been entered correctly. Proceed to **5.3b**.

→ The text **“ISL-8000”** is displayed.

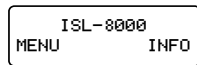

- The PIN has been entered incorrectly. Return to **5.3a**.

5.3b Activating diagnostic function

- Repeatedly press **+** until **“DIAGNOSTIC”** is displayed.
- Confirm PIN number by pressing **OK**.

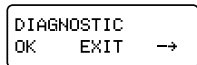

5.3c Aligning sensors

To support sensor alignment, the instantaneous received signal strength of the selected channel is displayed.

- Repeatedly press **+** or **-** until the signal strength **“SIGNAL”** of the desired channel, e.g. **“CH 1”** is displayed.
- Slowly turn the transmitter of the selected channel in all directions, until signal strength reaches a maximum.
- Slowly turn the receiver of the selected channel in all directions, until signal strength reaches a maximum.
- Again slowly turn the transmitter of the selected channel in all directions, until signal strength reaches a maximum.
- Again slowly turn the receiver of the selected channel in all directions, until signal strength reaches a maximum

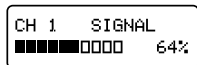

If no signal strength is displayed at all, this may be due to the following reasons:

Display	Meaning	Possible reasons
OFF	channel switched off	- the light-barrier channel has been switched off
SIGNAL 0%	no signal is received	- light path obscured by an object - too much distance (sensors) - insufficient alignment (sensors) - sensor error is displayed

table 4: Reasons if no signal strength

5.3 d Completing sensor alignment

→ **Another channel is to be aligned**

- Proceed to **5.3 c** to align the sensors of the next channel

→ **All sensors have been aligned**

- Press  once to exit diagnostic function menu.

The safety-light-barrier-amplifier leaves the programming mode and executes a reset.



Tip

*On leaving the diagnostic mode, it may take up to 10 s to adjust the transmit power of all of the channels. During this period all outputs are switched off for safety reasons. While operating, transmit power of all channels is stored on a regular basis. Thus, the correct transmit power is quickly restored on system restart. After changing the sensor topology or range a manual reset has to be triggered (refer to **6.3.5**) for readjustment.*

5.4 Finishing installation

After finishing installation, functional tests have to be executed. Manufacturing and commissioning tests may only be conducted by skilled personnel. This is to ensure the necessary protection to operate in accordance with its intended use.

5.4.1 Testing the channel assignment

After finishing installation, the correct assignment of all sensors must be validated. In order to do this, both the transmitter and the receiver of a light-barrier channel have to be covered separately. Care should be taken that the assigned LED changes from green to red twice. In addition, the assigned input of the superior control system must switch over (twice). Every channel of the safety-light-barrier-amplifier must be tested that way.

5.4.2 Testing detectability

The light-barrier safety outputs OSSD1 must switch to the off-state if a test specimen (opaque rod with 10 mm diameter and at least 150 mm in length) is intruding into the center of the light beam core (channel status indicator changes from green to red). Testing must be done at three different locations of the light beam:

- in close vicinity to the transmitter
- midway between transmitter and receiver
- in close vicinity to the receiver

In case any safety output OSSD1 does not switch during any test, the machine or plant may not be set into operation.

5.4.3 Testing the testing inputs

If the safety-light-barrier-amplifier is to be operated with external testing, the testing input must be verified as well. If applying a test signal all safety outputs OSSD1 must switch to the off-state.

6 Handling

6.1 Light-barrier-mode (run mode)

After powering up, the light-barrier-amplifier executes a self test.

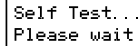

Self Test...
Please wait

In fault-free condition the device enters into RUN mode. The display shows the main menu.

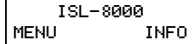

ISL-8000
MENU INFO

If a clear view exists between the transmitter and receiver of a light-barrier channel, the assigned channel status indicator illuminates green and the associated safety output is active. The transmit power of that light-barrier channel is automatically adjusted.

If the light-barrier's path of light is obstructed, the assigned channel status indicator illuminates red and the associated safety output is inactive.

If all of the light-barriers operate with automatic transmit power regulation active, the system status indicator "Gain control" illuminates green.

While the sensors slowly contaminate with time, the light-barrier-amplifier increases transmit power accordingly. As soon as the transmit power of any of the channels reaches 90% of maximum power, the system status indicator "Power limit" illuminates red and the alarm output is activated (24 V dc).

6.2 Displaying information

While the security-light-barrier-amplifier is integrated into the safety system, information about each channel may be displayed without interfering with the protective function. Moreover software revision and serial number may be displayed. All this is done by using the info menu.



Tip

If no button is pressed within 60 seconds, the amplifier returns to main menu automatically.

6.2.1 Displaying light path information

- Press \oplus once to enter the info menu.

The number of the currently selected channel is reported in the upper left corner of the display, e.g. "CH 1", meaning channel 1.

- Press \oplus or \ominus to advance to next channel.
- Press \otimes to exit info menu.

The following prompts may appear on Display with light path information (examples show only channel 1):



CH 1 Auto 1
Power ■■■■■■■■■■

The Channel is switched on. The bar graph indicates the current signal strength of about 60 % (10 % per Segment).



CH 1 OFF

The channel is switched off.

```
CH 1 Auto 1
LIMIT 0000000000
```

The channel is switched on. The bar graph indicates the current signal strength of about 0 %. The power capacity reached its limit and the alarm output is activated.

```
CH 1 Auto 1
RECEIVER FAIL
```

The channel is switched on. A receiver error is detected.

```
CH 1 Auto 1
TRANSMITTER FAIL
```

The channel is switched on. A transmitter error is detected.

6.2.2 Software revision and date of construction

- Press \oplus to enter the Info menu.
- Press \oplus or \ominus repeatedly until "Softw." is displayed (top row left hand side).

```
Softw. 0001.020
Date 01.01.2008
```

The upper row displays the software revision, the lower row states the date of construction.

- Press \otimes to leave the info menu

6.2.3 Serial number

- Press \oplus to enter the info menu.
- Press \oplus or \ominus repeatedly until "Serial No." is displayed.

```
Serial No.
000.000.002
```

The lower row displays the serial number of the device.

- Press \otimes to leave the info menu

6.3 Light-barrier setup



Hazard!

Adjustments may be made which suspend the protective function of the safety device.

Disconnect the power supply and secure against reactivation. If adjustments have been made, it is necessary to verify all protective functions of the safety device (refer to chapter **8 Regular inspection**). Only then, the machine may be reactivated.

In certain modes of operation, e.g. while programming or within diagnostic function, the outputs are in an off state for safety reasons. Returning to normal operation mode, they are switched active again bearing the risk of the machine to start up.

To adjust the light-barrier-amplifier, the programming mode has to be entered. During programming mode the normal light-barrier function is abandoned (stop mode, system status indicator "Operation" illuminates red). To prevent unauthorized changes, all of the following settings are PIN code protected (refer to **13.2 Identity Card**). The PIN code is only to be made known to authorized and skilled persons, e.g. for installation reasons.

6.3.1 Entering PIN code

- Press **OK** to enter programming mode
- **OK**-Taste drücken, um den Programmiermodus aufzurufen.

Two steps to enter the PIN:

- Press **+** to choose the number.
- Press **-** to choose the digit.

```
Enter PIN: 0000
OK  NEXT  SET
```

As soon as PIN is entered completely,

- Confirm PIN number by pressing **OK**

→ The text **“CHANNEL SETTINGS”** is displayed.

- The PIN has been entered correctly. Programming mode is active.

```
CHANNEL SETTINGS
OK  EXIT  →
```

→ The text **“ISL-8000”** is displayed.

- The PIN has been entered incorrectly. Try again entering the PIN code.

```
ISL-8000
MENU  INFO
```

6.3.2 Switching light-barrier channels on or off



Tip

Unused Channels, that is channels without connected sensors, need to be deactivated. This prevents these channels from generating a sensor failure signal and makes it possible to operate a cumulative output.

- Enter PIN code (refer to **6.3.1**)
- Press **+** repeatedly until **“CHANNEL SETTINGS”** is displayed.
- Confirm by pressing **OK**
- Press **+** repeatedly until desired channel is displayed
- Confirm by pressing **OK**

```
CHANNEL SETTINGS
OK  EXIT  →
```

```
SELECT CH. > 1
OK  EXIT  +
```

The mode of operation defines how transmit power is adapted to meet the environmental conditions. You may choose:

- Channel off** - The transmitter is switched off. You have to switch off all channels with no sensors connected.
- Automatic mode** - Transmit power is automatically adapted according to the given environmental conditions.

→ **Switch off a channel**

- Repeatedly press **+** or **-** until **“OFF”** is tagged.
- Confirm by pressing **OK**
- Setting of this channel is done.

```
CH 1 MODE
[OFF] AUTO
```

- → **Setting of the current channel is complete**
- - Select the next channel.
- → **Setting of all channels is complete**
- - Press ⊖ twice to leave the channel settings menu.

→ **Automatic mode**

The power range has to be chosen. It defines the reaction to sudden interruption of the light path e.g. in case of fast pollution of a sensor or introduction of foreign particles. The interruption has to be low enough to stop the automatic power regulation but not to interrupt the light-barrier entirely (regulation indicator off, channel status indicator green).

- A1 - Little interruption is necessary to switch off the light-barrier (high sensitivity). Transmit power regulation is stopped.
- A2 - A higher interruption is necessary to switch off the light-barrier (low sensitivity). Transmit power regulation is stopped.
- A3 - Little interruption is necessary to switch off the light-barrier (high sensitivity). Transmit power regulation is stopped for 30 seconds. Next, the transmit power is increased until the original switch-off sensitivity is reached again.
- A4 - A higher interruption is necessary to switch off the light-barrier (low sensitivity). Transmit power regulation is stopped for 30 seconds. Next, the transmit power is increased until the original switch-off sensitivity is reached again.

1. Choosing automatic mode

- Repeatedly press ⊕ or ⊖ until "AUTO" is tagged.
- Confirm selection by pressing OK

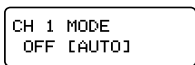

2. Choosing power range

- Repeatedly press ⊕ or ⊖ until the desired power range is tagged.
- Confirm selection by pressing OK

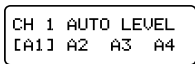

3. Completing the channel setting

- → **Setting of the current channel is complete**
- - Select the next channel.
- → **Setting of all channels is complete**
- - Press ⊖ twice to leave the channel settings menu.

6.3.3 Changing device settings

6.3.3.1 Activating / deactivating the cumulative output

The cumulative output function makes it possible to combine all eight protective outputs OSSD1 and assign the result to channel one. If all of the light-barriers have an unobstructed line of view, the first channel's protective output OSSD1 shows high level (24 V dc). By obstructing at least one light-barrier, the first channel's protective output OSSD1 switches to low level (0 V).

Possible choices are:

- ON - cumulative output function is activated
- OFF - cumulative output function is deactivated

- Enter PIN code (refer to 6.3.1)
- Press \oplus repeatedly until "SYSTEM SETTINGS" is displayed.
- Confirm by pressing OK
- Press \oplus repeatedly until "CURTAIN MODE" is displayed.
- Confirm by pressing OK

```
SYSTEM SETTINGS
OK  EXIT  -->
```

```
CURTAIN MODE
OK  EXIT  -->
```

→ Activating the cumulative output

- Press \oplus or \ominus repeatedly until "ON" is tagged.
- Confirm by pressing OK

```
CURTAIN MODE
OFF [ON]
```

→ Deactivating the cumulative output

- Press \oplus or \ominus repeatedly until "OFF" is tagged.
- Confirm by pressing OK

```
CURTAIN MODE
[OFF] ON
```

- Press \ominus once to leave cumulative output menu, twice to leave device settings menu.

6.3.3.2 Changing LCD contrast

By changing the LCD contrast, the display may easily be adapted to the ambient light conditions.

- Enter PIN code (refer to 6.3.1)
- Press \oplus repeatedly until "SYSTEM SETTINGS" is displayed.
- Confirm by pressing OK
- Press \oplus repeatedly until "LCD CONTRAST" is displayed.
- Confirm by pressing OK

```
SYSTEM SETTINGS
OK  EXIT  -->
```

```
LCD CONTRAST
OK  EXIT  -->
```

- Press \oplus or \ominus to change contrast
- Confirm by pressing OK

```
LCD CONTRAST
■■■■■■■■■■
```

- Press \ominus once to leave contrast setting menu, twice to leave device settings menu.

6.3.3.3 Changing the polarity of the testing inputs

If operated in external testing mode, the superior control system stimulates the testing input with a voltage of 0 ... 24 V dc. The polarity determines what voltage level triggers the testing sequence. Possible choices are:

- POS - Activation by applying high level (24 V dc)
- NEG - Activation by applying low level (0 V)

- Enter PIN code (refer to 6.3.1)
- Press \oplus repeatedly until "SYSTEM SETTINGS" is displayed.
- Confirm by pressing OK
- Press \oplus repeatedly until "TEST POLARITY" is displayed.
- Confirm by pressing OK

```
SYSTEM SETTINGS
OK  EXIT  -->
```

```
TEST POLARITY
OK  EXIT  -->
```

→ Activation by applying high level

- Press \oplus or \ominus repeatedly until "POS" is tagged.
- Confirm by pressing OK

```
TEST POLARITY
[POS] NEG
```

➔ **Activation by applying low level**

- Press ⊕ or ⊖ repeatedly until "NEG" is tagged.
- Confirm by pressing OK
- Press ⊖ once to leave polarity changing menu, twice to leave device settings menu.



6.3.4 Aligning sensors / Analyzing sensor failure / Verifying testing inputs

Aligning the light-barrier sensors, analyzing sensor failure and verifying the testing inputs is done by using the diagnostic function. The following information is displayed:

- Signal strength - Currently received signal strength to align sensors.
- Sensor status - Current sensor status to analyse sensor failure.
- Test status - Display of the currently applied voltage level to the testing input.

Signal strength and sensor status is displayed alternately for every channel 1-8. Test status is reported between display for channel 8 and channel 1.

- Enter PIN code (refer to 6.3.1)
- Press ⊕ repeatedly until "DIAGNOSTIC" is displayed.
- Confirm by pressing OK

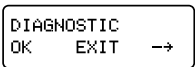

Use the next two steps to switch between the 'screens':

- Press ⊕ to advance to next item
- Press ⊖ to return to previous item

6.3.4.1 Aligning the light-barrier

- Press ⊕ repeatedly until "SIGNAL" of the desired channel is displayed.
- Slowly turn the transmitter of the displayed channel (e.g. channel 1) in every direction until signal strength reaches a maximum.
- Slowly turn the receiver of the same channel in every direction until signal strength reaches a maximum.
- Again, slowly turn the transmitter in every direction until signal strength reaches a maximum.
- Again, slowly turn the receiver in every direction until signal strength reaches a maximum.
- Press ⊕ once



In case signal strength remains 0, **table 5** may suggest some reasons.

Display	Meaning	Possible reason
CH 1 OFF	channel switched off	- The light-barrier channel has been deactivated
CH 1 SIGNAL ■■■■■■■■■■ 0%	no signal received	- obstacle between transmitter and receiver - sensors misaligned - sensors polluted - sensor failure is indicated

table 5: Reasons for missing signal strength

6.3.4.2 Analyzing sensor failure

If a sensor failure is indicated, additional information about the kind of failure may be displayed (refer to **table 6**)

Display	Meaning	Possible reason
OK	no error at all	
OFF	channel switched off	- The light-barrier channel has been deactivated.
OPEN	input shows high impedance	- Sensor not connected firmly - No sensor connected - Connected with reversed polarity - Wrong sensor connected
SHORT	input shows low impedance	- Sensor short circuited - Wrong sensor connected

table 6: Cause of sensor failure

6.3.4.3 Validating the testing input

The status of the testing input is displayed in order to validate if the signal fed to the testing input is sensed correctly.

- Press **+** repeatedly until "INPUT STATUS" is displayed.

```
INPUT STATUS
TEST1:0 TEST2:0
```

The status of the testing input 1 is displayed next to "TEST1:" and the status of testing input 2 next to "TEST2:". Take a look at **table 7** for possible combinations.

Display	Status
0	Testing input is inactive. The applied voltage is sensed as low signal.
1	Testing input is active. The applied voltage is sensed as high signal.

table 7: Results of "TEST INPUT"

- Press **OK** to leave diagnostic function menu

6.3.5 Reset transmit power

When resetting the transmit power, the amplifier reduces the transmit power from 100 % down to the needed value in a control loop.

- Enter PIN code (refer to **6.3.1**)
- Press **+** repeatedly until "RESET" is displayed.
- Confirm by pressing **OK**

```
RESET
OK   EXIT  ->
```

The light-barrier-amplifier executes a self test and returns to the main menu.



Attention!

While executing this reset, no person is allowed to stay within the restricted area. Sensors which have been blocked by pollution before may then generate an output signal.

6.3.6 Restoring factory settings



Attention!

Restoring factory settings renders the protective function of the security device inactive. The safety-light-barrier amplifier **must be** set into operation again afterwards (refer to chapter **5 Setting into operation**)

By loading the factory settings, all user defined settings are reset to standard values.

- All channels are active
- Light curtain disabled
- The testing input is high-level activated (POS)
- LCD contrast is set to 50 %
 - Enter PIN code (refer to **6.3.1**)
 - Press \oplus repeatedly until "FACTORY RESET" is displayed
 - Confirm by pressing $\text{\textcircled{OK}}$
 - Confirm security query by pressing $\text{\textcircled{OK}}$

FACTORY RESET
OK EXIT →

Clear all User
Settings OK?

After restoring factory settings, the light-barrier-amplifier executes a self test and returns to the main menu.

7 Error indication



Attention!

Troubleshooting should be done by skilled personnel only. After error-correction, all protective functions of the security device have to be validated (refer to chapter **8 Regular inspection**). Only then the machine or plant may be set into operation.

7.1 Error classification

Errors are classified according to their kind. Information about an error is given by LEDs as well as informative texts on the display. Refer to **table 8** for more information on error classification.



Display	LED	Problem
	No LED illuminates	No power supply
	System status indication "Power limit" illuminates red.	Power limit, refer to 7.2
	Channel status indication illuminates yellow.	Sensor error, refer to 7.3
	System status indication "OSSD2" flashes red.	External error, refer to 7.4
	System status indication "OSSD2" flashes red.	Internal error, refer to 7.5
	System status indication "OSSD2" illuminates red (continuous).	program execution error, refer to 7.6

table 8: Error classification

7.2 Power limit

One or more light-barriers have reached 90 % maximum transmit power. Transmit power capacity is almost exhausted. System status indication LED "Power limit" illuminates red and the alarm-output is active (24 V dc). However the light-barrier-amplifier is in service for now.

Service menu (refer to **6.2 Displaying information**) may be used to find out, which light-barrier(s) are affected. Table **table 9** gives an overview about possible reasons.

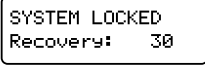
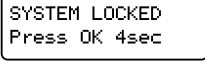
Display	Meaning	Possible reasons
System status indication "Power limit" illuminates red	Power capacity exhausted (Power limit)	<ul style="list-style-type: none"> - Light-barrier obstructed in part - Sensor pollution - Sensor failure

table 9: Possible reason if reaching power limit

7.3 Sensor failure

The Light-barrier-amplifier has sensed a failure at the sensor terminals. The display shows “SENSOR FAILURE” and the device name in turn. The error output is active (24 V dc). The yellow channel status LED indicates the affected channel(s). Further information may be obtained by activating the info menu (refer to **6.2 Displaying information**), e.g. if the fault pertains the transmitter or receiver. An overview about possible reasons gives **table 10**.

Display	Meaning	Possible reasons
CH 1 Auto 1 TRANSMITTER FAIL	Fault at transmitter terminal	<ul style="list-style-type: none"> - Transmitter not connected, e.g. a loosened wire - Transmitter short circuited - Connection lead defective - Transmitter defective
CH 1 Auto 1 RECEIVER FAIL	Fault at the receiver terminal	<ul style="list-style-type: none"> - Receiver not connected, e.g. a loosened wire - Receiver short circuited - Connection lead defective - Receiver defective

table 10: Possible reason in case of a sensor fault (e.g. at channel 1)

More detailed information, if needed, e.g. short circuited or open circuited, may be gained by executing a sensor analysis according to **6.3.4 Aligning sensors / Analyzing sensor failure / Verifying testing inputs**).

7.4 External Error

This category summarizes all faults caused by external influences (except sensor fault), e.g. short circuit at the outputs, supply voltage dropout etc.

The system status indication LED “OSSD2” flashes red. Light-barrier function is suspended and the amplifier enters a time-limited locking state. If, after a while, the fault is not present anymore, the light-barrier-amplifier executes a self test and resumes normal operation.

By pressing ⊕ some information and possible reasons will be displayed according to **table 11**.

Display	Meaning	Possible reasons
ERROR VOLTAGE LOW	low supply voltage	<ul style="list-style-type: none"> - voltage outside specification - loose connection
ERROR VOLTAGE HIGH	high supply voltage	<ul style="list-style-type: none"> - voltage outside specification
ERROR TRANSM. CURRENT	incorrect transmitter current	<ul style="list-style-type: none"> - transmitter connected or disconnected during operation
ERROR TRANSM. MULTIPLEXER	error at transmitter multiplexer	<ul style="list-style-type: none"> - short circuit between transmitter terminals
ERROR AMBIENT LIGHT	foreign light, e.g. by other light-barrier systems	<ul style="list-style-type: none"> - different light-barrier system, infrared transmitters etc. 'blinding' the receivers

Display	Meaning	Possible reasons
ERROR OUTPUT OSSD1	error at output OSSD1	- short circuit against supply voltage - short circuit between outputs (channel 1 to 8)
ERROR OUTPUT OSSD2	error at safety output OSSD2	- short circuit against supply voltage - short circuit between outputs (channel 1 to 8)
ERROR USE INTERFACE	received corrupt command	- wrong PC software - defective data cable

table 11: Possible reasons for external error

7.5 Internal error

All hardware faults that may be detected by software are regarded as internal errors. The system status indication LED "OSSD2" flashes red. Light-barrier function is suspended and the amplifier enters a time-unlimited locking state until a manual reset is executed by the operator. The light-barrier-amplifier then resumes normal operation if the error condition has been removed.

7.6 Program execution error

Program execution is permanently monitored. In case of abnormal execution, e.g. due to processor or memory malfunction, the light-barrier function is suspended. The amplifier enters a time-unlimited locking state and the system status indication LED "OSSD2" illuminates red (continuously). Both outputs "OSSD1" and "OSSD2" are switched off (low, 0 V). The safety-light-barrier-amplifier cannot be set back to normal operation.

8 Regular inspection



Hazard!

Should the inspection result in detection of an error, the machine or plant in question has to be put out of operation. It may not be brought back to service until skilled personnel has examined and repaired the error causing element and determined that the protective function of the security equipment has been restored.

Depending on regulatory provisions in force, safety devices have to be examined on a regular basis. An overall analysis of the safety devices has to be undertaken at regular intervals (no longer than 1 year) by skilled personnel to uncover changes, modification or manipulation of the security structure.

A visual inspection might uncover mechanical damage of the equipment that may at some time lead to malfunction. A more in-depth functional inspection has to be done by trained personnel which includes tests with test specimen (opaque rod with 10 mm diameter and at least 150 mm in length). If placed into the center of the light beam core, the assigned safety output "OSSD1" has to change to the low state (0 V) and the channel status indicator changes from green to red.

Testing has to be done in three different locations of the light beam:

- in close vicinity to the transmitter
- midway between transmitter and receiver
- in close vicinity to the receiver

In the case that any safety output does not respond at any of the tests, the machine or plant may not be set into operation.

9 Maintenance

The safety-light-barrier-amplifier does not need maintenance.

10 Technical Data

Supply voltage U_s	24 V DC ($\pm 20\%$), fused (Kap. 4.2)
Current consum I_s ($I_{OUT} = 100$ mA)	max. 1,4 A
Mode of operation	Modulated infrared light
Modulation frequency	4,0 kHz
Overall reaction time	≤ 36 ms
Detectability	$\varnothing \geq 10$ mm
Maximum range (through beam)	25 m
Minimum distance transmitter, receiver	0,3 m
Self-test cycle time	4,4 min
Safety and functional outputs	pnp/npn, Push-pull
U_{OUT} High	$> U_s - 0,9$ V
U_{OUT} Low	$< 0,32$ V
Output current I_{OUT}	100 mA
Leakage current	< 2 mA
Internal resistance R_{DSON}	$< 1,6$ W
Capacitive load	max. 470 nF
Testing input	
Switching level (polarity = pos) (polarity = neg)	low: 0...5 V DC / high: 15 V DC... U_s high: 0...5 V DC / low: 15 V DC... U_s
Reaction time	≤ 10 ms
Current consumption	< 2 mA
Electrical terminal	Screw connector 0,14 ... 2,5 mm ²
Connection line	max. length 50 m
Material (enclosure)	NORYL, grey
Safety catgory	Type 2 acc. EN 61496-1
Safety Integrity Level	SIL 1 acc. EN 62061
Residual error probability (PFH)	$2,4 * 10^{-08}$ /h
Enclosure type	IP20
Operating temperature	-10 °C ... 50 °C
Storage temperature	-20 °C ... 60 °C
Humidity	15 ... 95 %, non-condensing

table 12: Technical Data at 20 °C

11 Dimensioned drawing

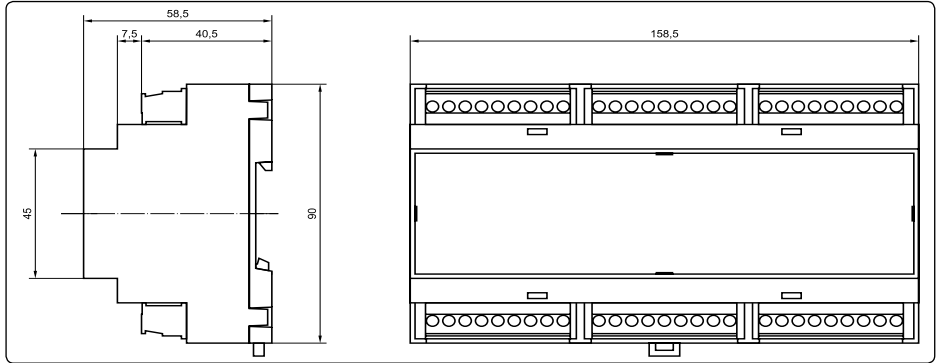
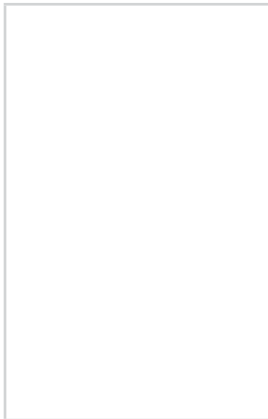

figure 4: Drawing, dimension in mm

12 Type lable



13 Appendix

13.1 EU-Declaration of conformity



EC-DECLARATION OF CONFORMITY - Original Declaration -

Manufacturer: **Pantron Instruments GmbH**
Address: **Süllbergstraße 3-5**
D-31162 Bad Salzdetfurth
Germany

Type or Model: **ISL-8000/24VDC**
Product description: **8-channel Safety Light Barrier Amplifier**

Type or Model: **IST-... ISR-...**
Product description: **Infrared Transmitter and Receiver for Safety Light Barrier Amplifier**

The Safety Light Barrier Amplifier is in compliance with the observed regulations only when used with the Pantron sensor heads: IST-... and ISR-...

This equipment is in compliance with the essential requirements and other relevant provisions of the following directives:

<u>Number / Title</u>	<u>Observed regulations</u>	
2006/42/EG (Machinery)	DIN EN 61496-1:2004 + A1:2008	Safety of machinery - Electro-sensitive protective equipment - Part 1: General requirements and test
	IEC 61496-2:2005	Part 2: Particular requirements for equipment using active opto-electronic protective devices (ACPDs)
	DIN EN 62061:2005	Safety of machinery - Functional safety of safety-related electrical, electronic and programmable electronic control systems
2004/108/EG (EMC)	DIN EN 61496-1:2004 + A1:2008	Safety of machinery - Electro-sensitive protective equipment - Part 1: General requirements and test

Person authorised to compile the technical file: **Pantron Instruments GmbH**

Notified body which carried out the EC type-examination referred to in Annex IX: **TÜV NORD CERT GmbH**
Langemarckstr. 20
D-45141 Essen, Germany
Identification number: 0044

Number of the EC type-examination certificate: **44 205 11 334418 000**

Issuer:

Bernd Otleben
General Manager
Pantron Instruments GmbH

Bad Salzdetfurth, 12.02.2011
Place, Date

This declaration certifies the compliance with the indicated regulations, it does however not guarantee features or facilities. Pay attention to the security advice of the relevant product information.

13.2 Identity Card

To prevent unauthorized changes, all settings are PIN code protected (Identity Card). The PIN code is only to be made known to authorized and skilled persons, e.g. for installation reasons.

Separate this page from the manual and store it at a secret and safe location apart from the safety-light-barrier-amplifier.

Device number

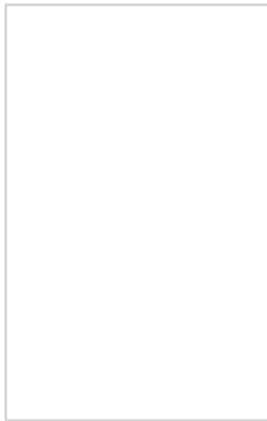

PIN number



Pantron Instruments GmbH
Süllbergstraße 3-5
31162 Bad Salzdetfurth
Germany

phone: +49 (0) 5063/9591-0 • Telefax: +49 (0) 5063/9591-55
Internet: www.pantron.de • E-Mail: info@pantron.de



Pantron Instruments GmbH
Süllbergstraße 3-5
31162 Bad Salzdetfurth
Germany

phone: +49 (0) 5063/9591-0 • Telefax: +49 (0) 5063/9591-55
Internet: www.pantron.de • E-Mail: info@pantron.de