



Data Sheet ME22-PU



www.pwb-encoders.com

precision works better



**PWB encoders GmbH
Am Goldberg 2
D-99817 Eisenach
Germany
Phone: +49 3691 72580-0
Fax: +49 3691 72580-29**

**info@pwb-encoders.com
www.pwb-encoders.com**

Description

The ME22 is a reliable low cost optical hollow shaft encoder that can be fixed quickly and easily on different sizes of motor shafts.

The encoder provides two square wave outputs in quadrature (90 degrees phase shifted) for counting and direction information and one optional index channel (one pulse per revolution). The resolution of the encoder is determined by the number of counts per revolution (CPR). Power supply and signals are provided by a 5 pin Molex connector.

Dimensions

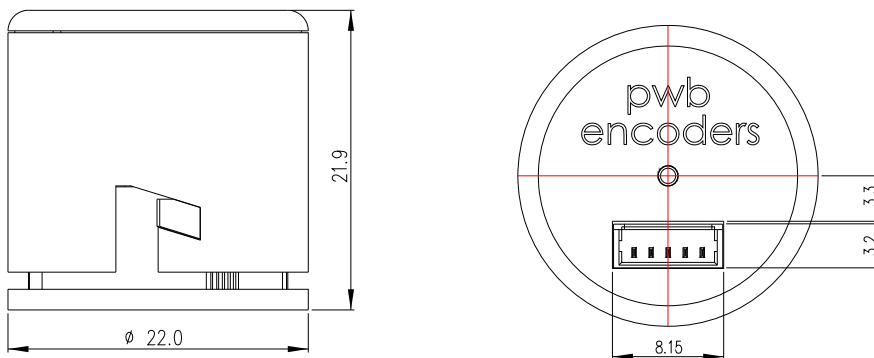

Encoder Resolution (CPR)
001
002
004
008
050
064
100
108
120
124
125
128
150
160
200
250
256
300
360

Features

- Small size: 22.0 mm diameter x 21.9 mm length.
- Quick and easy assembly without touching sensitive components
- Output channels: 2 (quadrature) + 1 optional index-channel
- Power supply: 5 VDC
- Output type: TTL compatible
- Output circuit: pull-up
- Resolution up to 360 CPR (counts per revolution)
- Maximum shaft diameter: 9.525 mm (3/8")
- Operating temperature: -20 °C to 85 °C
- Frequency: 60 kHz
- Compliant EU-directive 2002/95/EG (RoHS)

Motor shaft Ø Diameter (mm)
1.500
2.000
2.300
2.500
3.000
3.175 (1/8")
3.969 (5/32")
4.000
4.763 (3/16")
5.000
6.000
6.350 (1/4")
8.000
9.000
9.525 (3/8")



Recommended operating conditions

Electrical characteristics are only effective for the range of the operating temperatures.
Typical values at 25 °C and V_{CC} = 5 VDC.

Parameter	Symbol	Min.	Typ.	Max.	Unit	Notes
Operating temperature	T _A	-20	25	85	°C	
Supply voltage	V _{CC}	4.5	5.0	5.5	V _{DC}	
Supply current (two channels)	I _{CC}	13	15	18	mA	
Supply current (three channels)	I _{CC}	33	35	38	mA	
Load capacitance	C _L			100	pF	internal pull-up 2.7 kΩ
Count frequency	f			60	kHz	rpm x N / 60 x 10 ⁻³
A & B Channel						
High level output voltage	V _{OH}	2.4		V _{CC}	V _{DC}	I _{OH} = -0.2 mA
Low level output voltage	V _{OL}			0.4	V _{DC}	I _{OL} = 8.0 mA
Rise time	t _r		500 / (7) ²		ns / (μs) ²	C _L = 25 pF;
Fall time	t _f		100 / (1.3) ²		ns / (μs) ²	R _L = 2.7 kΩ
Index Channel						
High level output voltage	V _{OH}	2.4		V _{CC}	V _{DC}	I _{OH} = -0.2 mA
Low level output voltage	V _{OL}			0.4	V _{DC}	I _{OL} = 8.0 mA
Rise time	t _r		7		μs	C _L = 25 pF;
Fall time	t _f		1.3		μs	R _L = 2.7 kΩ

1. on demand
2. only for 1,2,4,8 CPR variant

Absolute maximum ratings

Parameter	Symbol	Min.	Typ.	Max.	Unit	Notes
Storage temperature	T _s	-40		85	°C	
Operating temperature	T _A	-20		85	°C	
Humidity exposure				90	% RH	not condensing
Supply voltage	V _{CC}	-0.5		7	V _{DC}	
Output voltage	V _O	-0.5		V _{CC}	V _{DC}	
Output current per channel	I _{out}	-1.0		8	mA	
Vibration				2000	Hz	20 g

ESD Warning: Normal handling precautions should be taken to avoid static discharge damage to the sensor.

Electrical interface

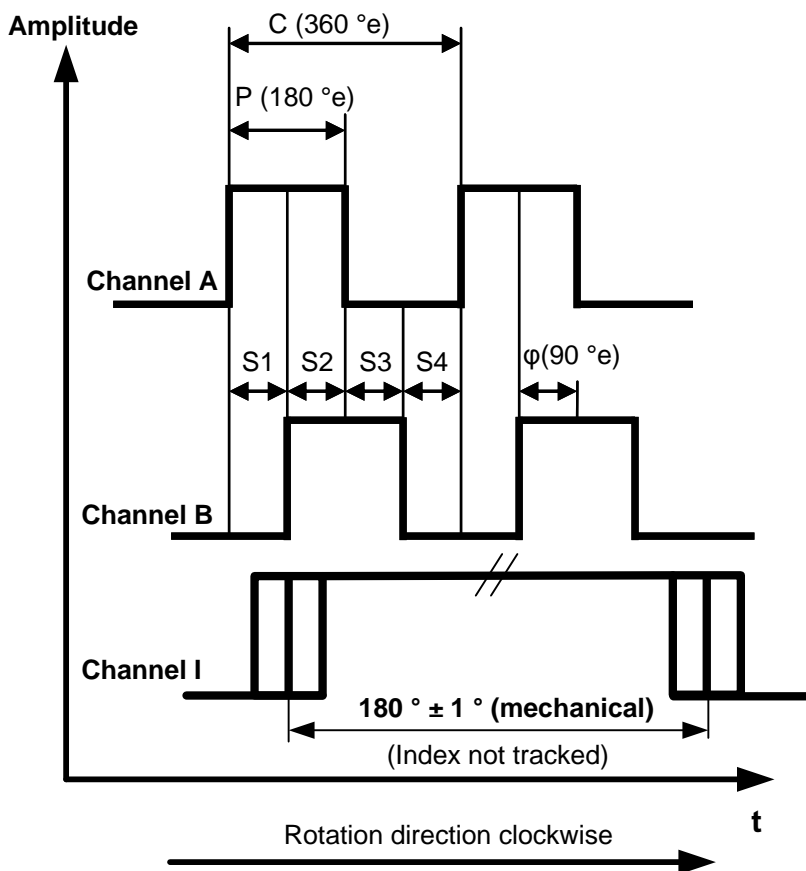
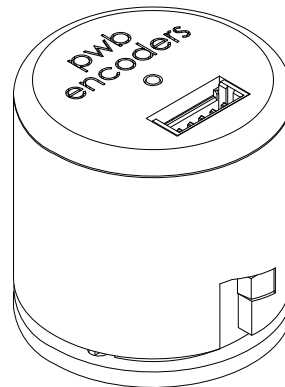
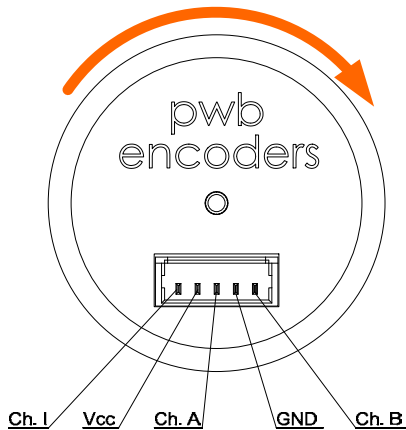

Definitions

Counts per Revolution (CPR):

The number of bar and window pairs or increments per revolution of the code wheel.

One Cycle (C):

360 electrical degrees ($^\circ e$), one period of the signal, caused by one pair of bar and window.

Pulse Width (P):

The number of electrical degrees that an output is high during one cycle. This value is nominally $180^\circ e$.

State Width (S):

The number of electrical degrees between a transition in the output of channel A and the neighbouring transition in the output of channel B. There are 4 states per cycle, each nominally $90^\circ e$.

Phase (ϕ):

The number of electrical degrees between the centre of the high state of channel A and the center of the high state of channel B. This value is nominally $90^\circ e$.

Position Error (ΔQ):

The angular difference between the actual angular shaft position and the position indicated by the encoder cycle count.

Encoding characteristics channel A & B

Parameter	Symbol	Nominal	Max.Error	Unit
Pulse width	P	180	± 70	$^\circ e$
Phase shift	ϕ	90	± 60	$^\circ e$

Mechanical Notes

Parameter	Value	Tolerance	Unit
Outer dimensions	Ø 22.0 x 21.9	-	mm
Shaft diameter \varnothing_w	1.5 / 2.0 / 2.3 / 2.5 / 3.0 / 3.175 / 3.969 / 4.0 / 4.763 / 5.0 / 6.0 / 6.35 / 8.0 / 9.0 / 9.525	±0.01	mm
Required shaft length L_w	9.5	+2.0	mm
Max. allowable axial shaft play of motor	0.6	-	mm
Max. allowable radial shaft play of motor	0.025	-	mm
Mounting screw size (DIN 84)	M1.6	-	-
Tightening torque of the screws	15	-5	Ncm
Pitch circle diameter \varnothing_c	17.0	±1.0	mm
Flange bore diameter diameter \varnothing_z	7.1 or 10.1	+0.03	mm
Mounting boss diameter \varnothing_m	7.1	-0.03	mm
Max. mounting boss height h_z	1.5	-0.1	mm
Mating connector (Molex)	contact 5x 50079-8000 housing 1x 51021-0500	-	-
Total weight	7	-	g
Moment of inertia of the hub with the code wheel	5.2	±1.0	gmm ²
Protection grade according to DIN 40500	IP50	-	-

Mounting considerations:

The ME22 encoder is designed to self align by using a mounting boss. The drawing shows the configuration of the mounting boss along with the location of the mounting screw holes. Shaft diameter and tolerances are given in the above mentioned chart.

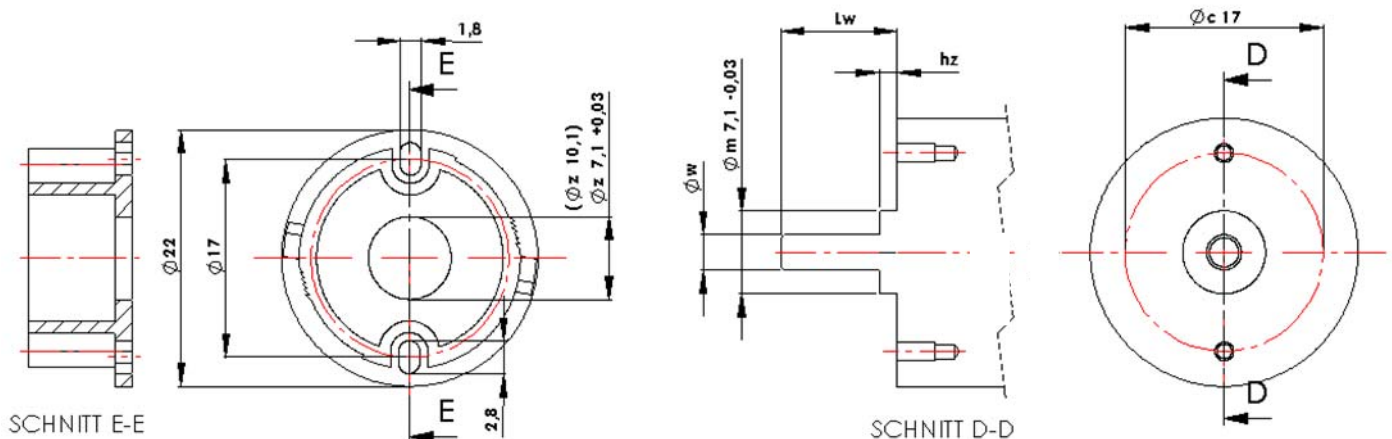

Ordering information

Ordering code:

ME22 - **XXX** - **X.XXX** - **X** - **XXX**

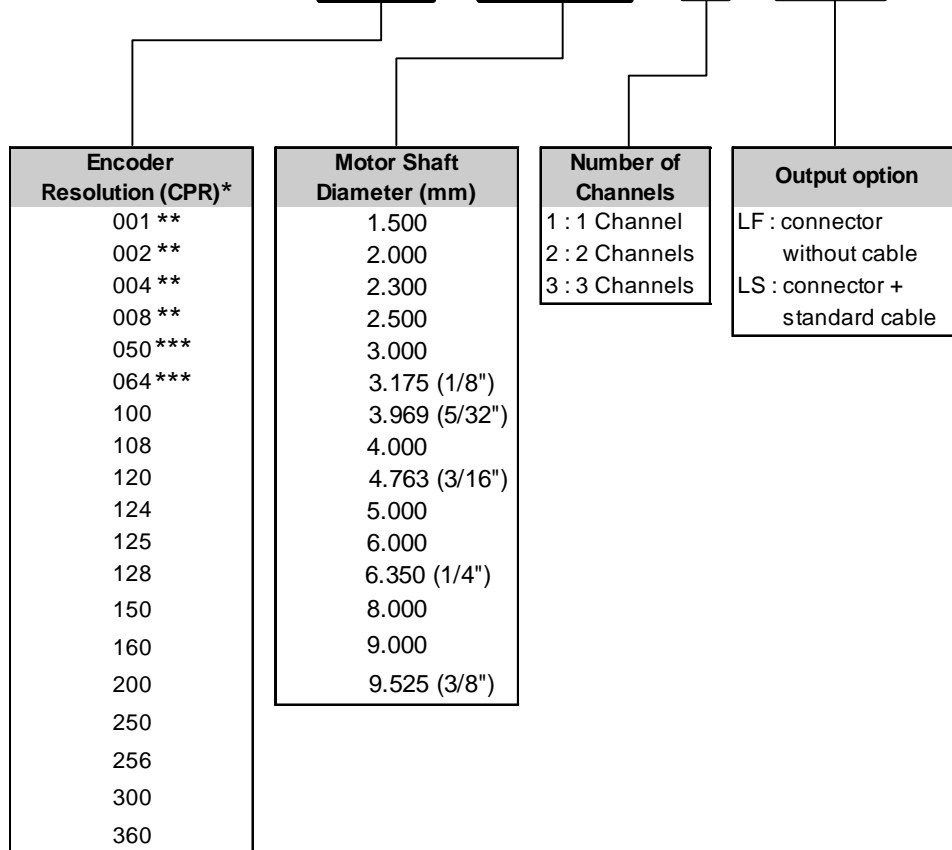

Note:

* other encoder resolutions on request

** only two channel

*** only one channel

Available accessories see page 9 (no parts of standard delivery):





- cable 300 mm length (UL1061 / AWG28)
- adapter plates for different motors
- centering gauge for different motor shafts
- fastening screws DIN 84 M1.6x3 or M1.6x4

PWB encoders GmbH RESTRICTED

THIS DOCUMENT AND ANY ASSOCIATED DATA CONTAIN RESTRICTED INFORMATION THAT IS PROPERTY OF PWB encoders GmbH AND MAY NOT BE DISCLOSED OR DUPLICATED FOR OTHERS EXCEPT AS AUTHORIZED BY PWB encoders GmbH

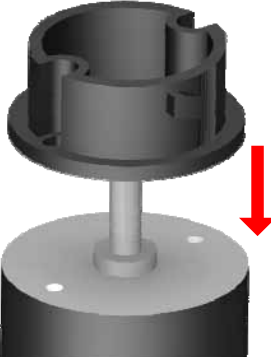
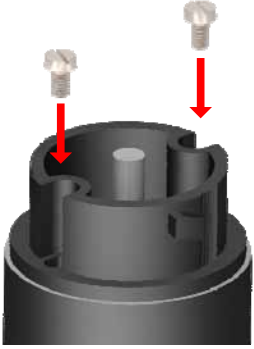
INFORMATION CONTAINED IN THIS PUBLICATION MAY BE SUPERSEDED BY UPDATES. IT IS YOUR RESPONSIBILITY TO ENSURE THAT YOUR APPLICATION MEETS WITH YOUR SPECIFICATIONS.

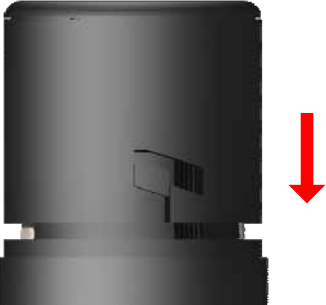
Patents: U.S 5,828,047 ; U.S 5,508,088 ; U.S 5,859,425 ; U.S 6,462,442

ME22 MOUNTING INSTRUCTION	
1	 <p>Align the base plate to the motor shaft by using the centering gauge</p>
2	 <p>Afterwards fix the base plate to the motor flange using two screws</p>
3	 <p>Align the housing to the base plate slide the housing onto the base plate</p>
4	 <p>... and the hub centers itself on the motor shaft</p>
5	 <p>From this position the housing cannot be locked</p>
6	 <p>Press the housing into the final position</p>

ME22 MOUNTING INSTRUCTION

7



Now the housing can be locked

8



Turn the housing into its final position, the encoder is now ready for use

WARNING



Do not rotate and pull out the encoder after assembly or when it is in operation.

ATTENTION!

The encoder is so designed that it may be assembled only one time, otherwise the guarantee will be voided. Note: see IMPORTANT NOTICE (page 9)

Available accessories

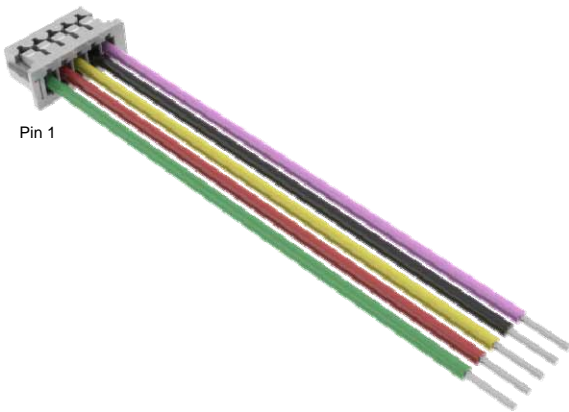

Standard cable length 300 mm
(UL 1061 / AWG 28)



Centering gauge for centering the ME base
plate on the motor flange or an adapter plate



Customized adapter plate



Screws DIN84 M1.6 X 3 or M1.6 X 4

IMPORTANT NOTICE

The encoder is so designed that it may be assembled only one time, otherwise the guarantee will be voided.

The guarantee will be voided by misuse, accident, modification, unsuitable physical or operating environment, operation in other than the specified operating environment, or failure caused by a product for which **PWB encoders GmbH** is not responsible.

PWB encoders GmbH reserves the right to make corrections, modifications, enhancements, improvements, and other changes to its products and services also datasheets at any time.