

Optical Belt Scale



Instalation & User Manual

! Attention, important safety advice !

Do not switch on the sensor until it is completely mounted on the machine and the laser sources are aligned to the conveyor. The switched on sensor sends invisible laser radiation during the measuring procedure. The sources of laser are activated only when the conveyor is moving. This condition is indicated by the blinking red signal lamp.

When the conveyor is not moving, the sources of laser are switched off automatically. This state is indicated by the red signal lamp with a short flashing signal, followed by a long pause.

However, to guarantee maximum safety, it should be always avoided to look directly into the optical outlets while the sensor is current supplied.

Welding current flowing through the sensor unit causes damage to the Optical Belt Scale!

Content

1	Extent of delivery	4
2	Installation of the Optical Belt Scale System	6
2.1	Installing the inductive proximity switch sensor	6
2.2	Connecting the Power Supply Cable.....	7
2.3	Mounting of Sensor Unit.....	7
2.4	Connecting the cables of the system	10
3	Getting Started with the Mobile Phone	11
3.1	Inserting the battery	11
3.2	Powering on the Mobile Phone	12
3.3	Set User Interface Language	13
3.4	Set Date & Time.....	14
4	Start of SensorManager Application	14
4.1	Connecting to Sensor Unit	15
4.2	Setting Time & Date of Sensor Unit	15
4.3	Configuration of Drum Diameter	16
4.4	Calibration Run	16
4.5	Input Master Data.....	17
4.6	Start New Measurement	18
5	Adjusting	19
5.1	Start test measurement.....	19
5.2	Setting the span adjust.....	21
6	Measurements.....	22
6.1	Print measurements	22
6.2	Print downloaded measurements.....	23
6.3	Send measurements as e-mail attachment.....	24
6.4	View downloaded measurement as Excel spreadsheet.....	24
6.5	Location of exported XLS-File on the mobile phone	25
6.6	Copying the XLS-file to your desktop over USB-Cable	25
7	System Settings.....	26
7.1	Admin(Login/Logout).....	26
7.1.1	Change Login Password.....	26
7.2	Configuration.....	26
7.3	Clock.....	26
7.4	Language	27
7.5	Memory	27
7.5.1	Clear Memory	27
7.6	Units.....	28
7.6.1	Setting the specific weight of a material.....	28
7.7	Print-Settings	29
7.8	Pairing & Selecting the printer.....	29
7.9	System	30
7.10	Diagnostic report	30
8	Thermal Bluetooth Printer.....	31
8.1	Loading paper	31
9	Safety Instructions Laser Class	32
9.1	Laser Class of Device	32
9.2	Warning.....	32
10	Servicing and cleaning.....	32
11	Spare parts.....	33

12	Connector & Cable Configurations	35
12.1	Power supply connector on Sensor.....	35
12.2	Inductive switch connector on Sensor.....	35
12.3	Power supply cable 2.5m	35
12.4	Power supply cable 15m	36
12.5	Inductive switch cable 2.5m	36
12.6	Inductive switch cable 0.5m	36
12.7	Inductive switch.....	37
12.8	Data cable 3m.....	37
13	Drawings	38

Contact:

H-Sensortechnik GmbH

Oberer Markt 3 · 4332 Au/Donau · Austria

Tel: +43 (0) 7262 54655 fax: +43 (0) 7262 54655 90

mail: office@h-sensortechnik.com · www.h-sensortechnik.com

1 Extent of delivery

Sensor Unit



CAT B15Q Mobile Phone, Charger unit 110/220V, USB/charging cable, USB Charger unit for 12V/24V



Thermal Printer + charger unit 110/220V + thermal paper



Frame & Bolts



Inductive sensor + Support bracket for the inductive sensor



Inductive sensor cable 0,5m + Inductive sensor cable 2,5m



Power cable 2,5m + 15m



Optional DC/DC Converter 12V/24V 10A + Cables



Technical Data
U In: 11V ... 14,5V
U Out: 24V, limited to 26V
I Out: 6A

2 Installation of the Optical Belt Scale System

2.1 Installing the inductive proximity switch sensor

The inductive sensor is there to measure the drum speed and has to be mounted in a good position on the drive pulley of the belt conveyor. (see picture for better understanding)

The inductive sensor on the bracket and the impulse sensor on the conveyor drum shaft must be aligned that they pass each other in a distance of 3–5 mm [0,18 - 0,197 inch]

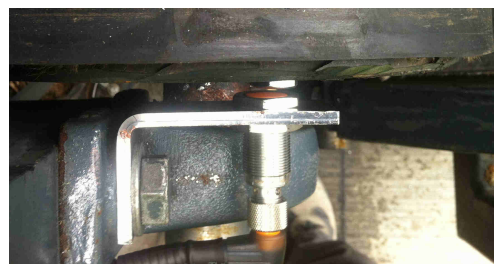
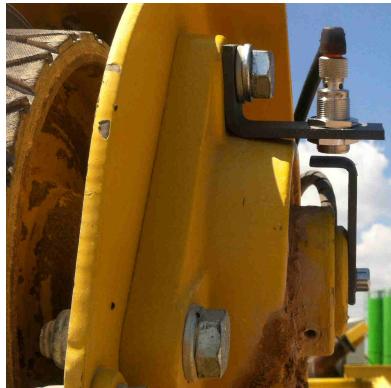
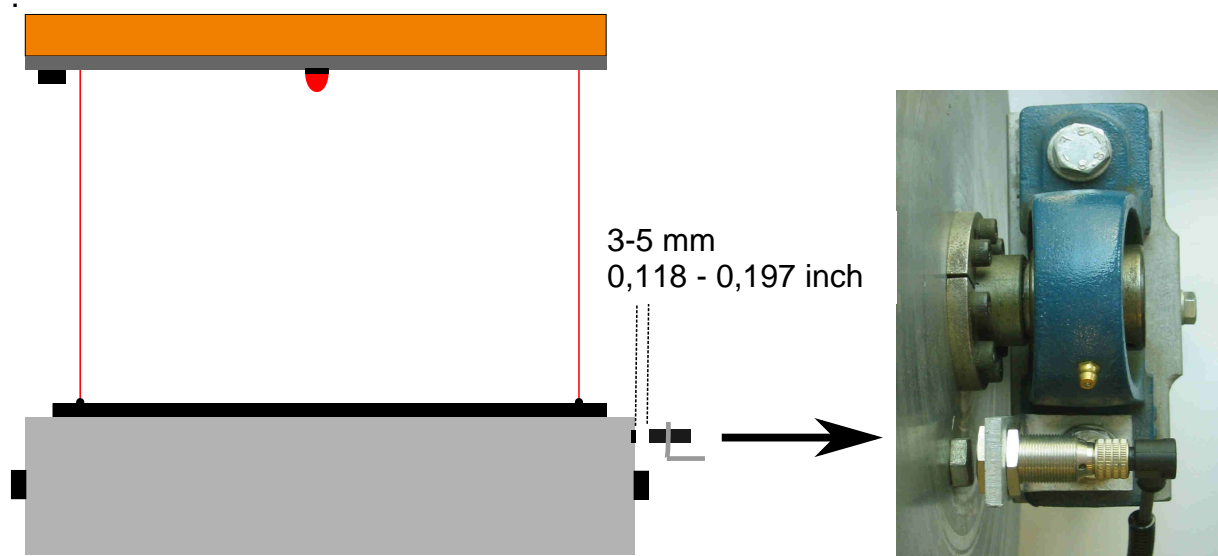

2.2 Connecting the Power Supply Cable

Connect the power supply cable (Cable D) to the power source. The optical belt scale needs 24V DC 5 A power source.

Power supply cable D	
Pin 1 / brown wire	+24V DC
Pin 2 / blue wire	-24V DC (GND)



2.3 Mounting of Sensor Unit

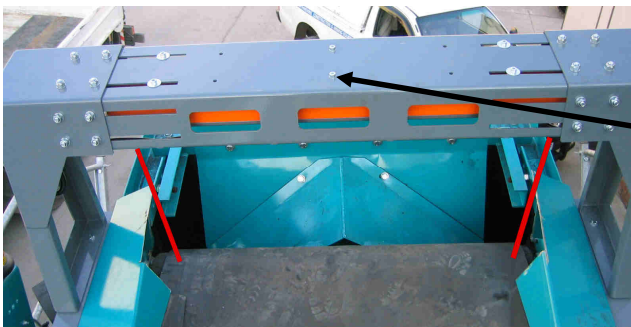

M8 hex socket head screw

The sensor is bolted on the frame with 6 pieces M8 hex bolts which are supplied with the unit.

Be sure to not exceed the maximum mounting height of 600mm [23,622 inch]. A mounting position on 600 mm [23,622 inch] distance allows to measure material with height of 400mm [15,758 inch] on the belt. If the mounting height falls below 600mm [23,622 inch], it will narrow the full measuring range.

After powering on the sensor, two red laser dots will be visible for about 5 minutes. Use these two dots, which are marking the active measuring line to position the sensor accordingly the pictures.

To power on the sensor connect the power supply cable **C** to the sensor and to the power supply cable **D**

The sensor has to be on the apex of the roller. Use the two red laser dots (one on each side of the sensor) to check whether they match the point of contact between belt & drum exactly!

Also be sure to pay attention to the running direction of the conveyer!
The sensor has to be mounted in the right direction!

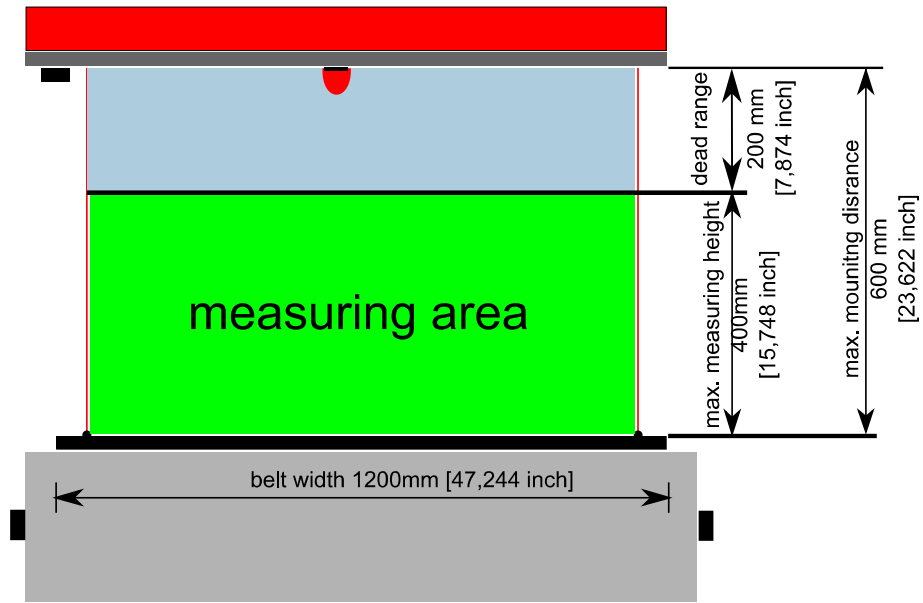

Sensor over discharge drum

Sensor over roller station

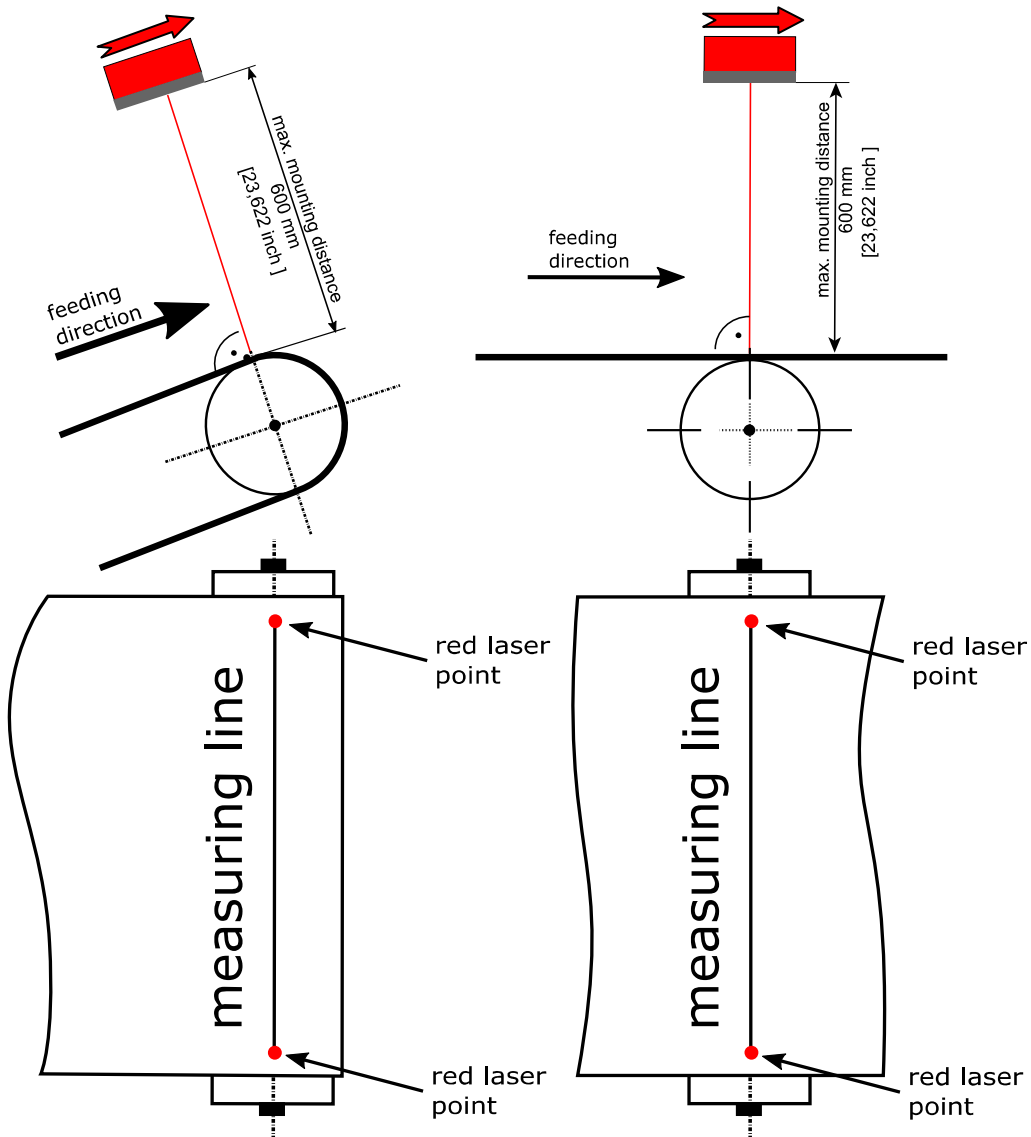

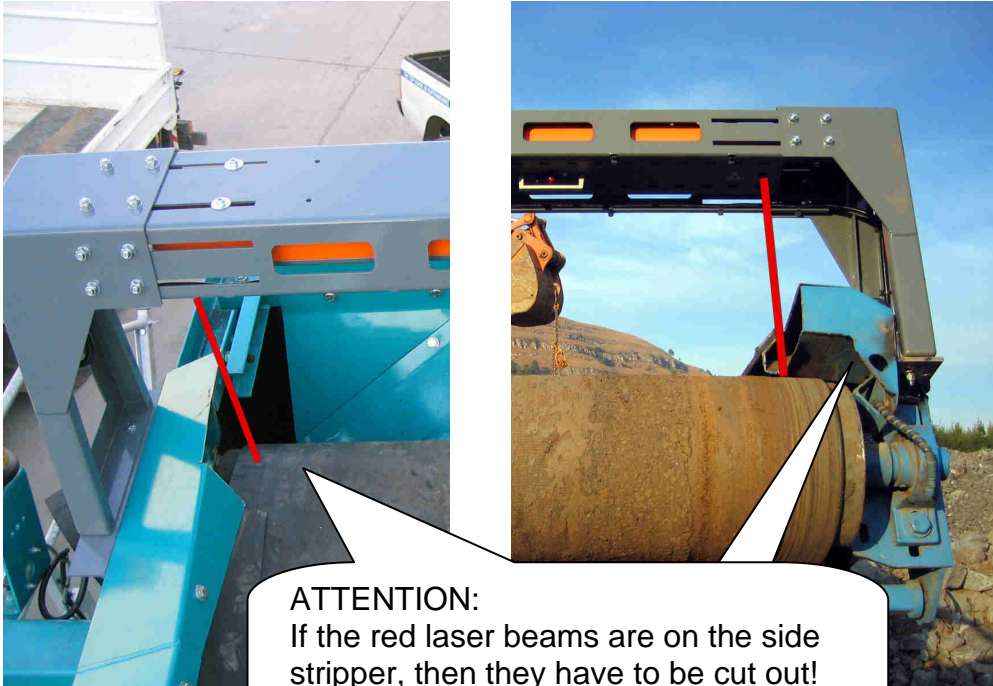

ATTENTION:
 If the red laser beams are on the side
 stripper, then they have to be cut out!
 The side strippers should be cut like on
 the pictures!

The following table shows, which sensor fits best to each conveyor belt width

Sensor	Conveyor belt width [mm]	Conveyor belt width [inch]
600	400 – 600	15.7 – 23.6
800	600 – 800	23.6 – 31.5
1000	800 – 1000	31.5 – 39.4
1200	1000 - 1300	39.4 – 51.2
1400	1300 - 1600	51.2 - 63.0

2.4 Connecting the cables of the system

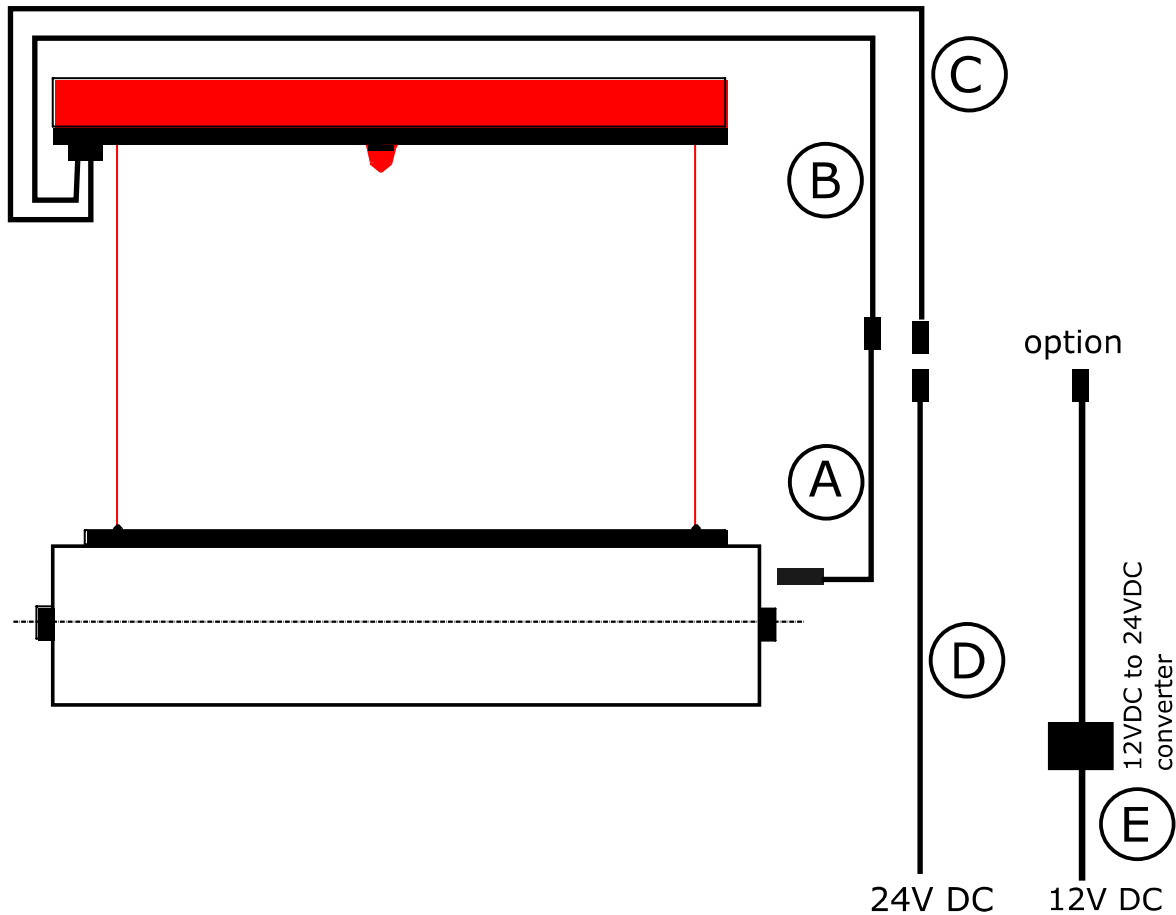

Connect the inductive sensor to the measuring sensor using the data cable **A & B**. The sensor is then connected to 24 V DC / 5 A power source using the power supply cables **C & D**. If the sensor is used in conjunction with a 12 Volt powered system, the DC/DC converter **E** has to be used. It is advised to connect the sensor to the power supply at the ignition so that the sensor is only turned on when the ignition is on and the plant is running.

Following please find the occupancy of the cable D:

Power supply cable D	
Pin 1 / brown wire	+24V DC
Pin 2 / blue wire	-24V DC (GND)

You must take care when mounting all the cables to ensure that they can't be damaged or squashed when the plant is working or when the plant is being transported i.e. the conveyors are folded.

3 Getting Started with the Mobile Phone

3.1 Inserting the battery

1. Slide the back cover latch to the unlock position.



2. Hook your fingertip under the back cover.



3. Pry to open the back cover.



4. You now have access to battery compartment. Insert the battery. Make sure the contacts of the battery are aligned with the connectors in the battery compartment.



5. Make sure the rear cover is the correct way round.



6. Engage the hooks on the top of the back cover with the designated holes on your phone.



7. Push the back cover firmly to secure it into place.
 Note: Be careful not to bend the lugs/catches/hooks on the battery cover.



8. Press and hold the bottom of the back cover and slide the back cover latch to the left to lock the back cover.



3.2 Powering on the Mobile Phone

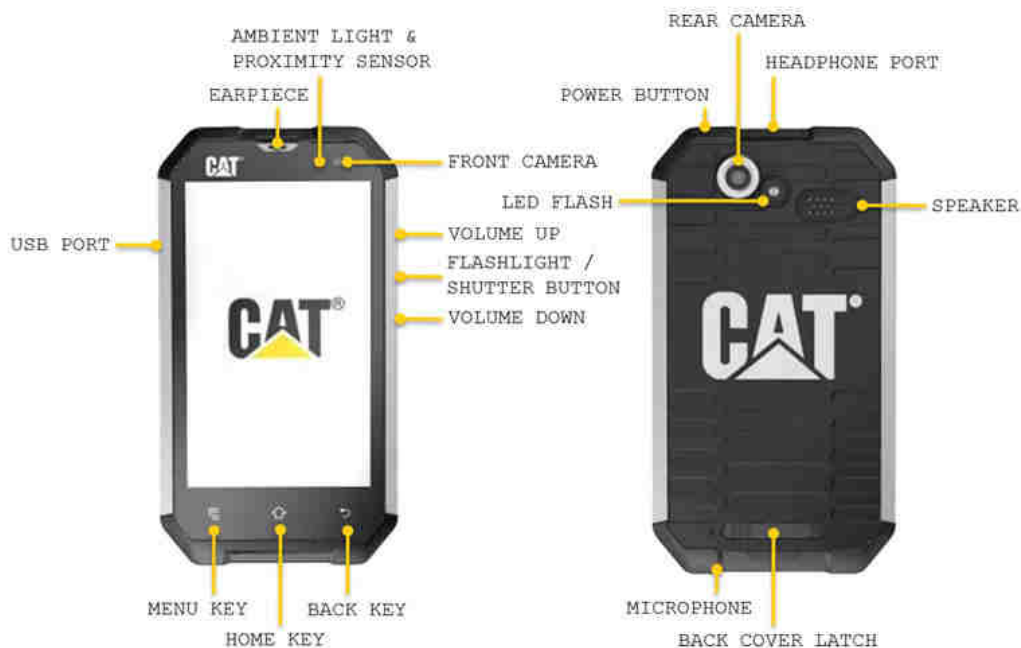

To power on press the Power button.

Key functions at your fingertips:

Power button: Press to turn on your mobile phone.
 Press and hold to open the Phone options menu.
 Press to lock or wake the screen when your mobile phone is on.

Home key: Press at any time to display the Home screen. A long press of the Home key will launch Google search or Google Now.

Menu key: Touch to open a menu with options that relate to the current screen or application.
A long press of the Menu key will list the recent applications used.
A short press of the Menu key from the Home screen will display all screen and icon settings.

Back key: Touch to display the previous screen you were working in.
Use to close onscreen keyboard.

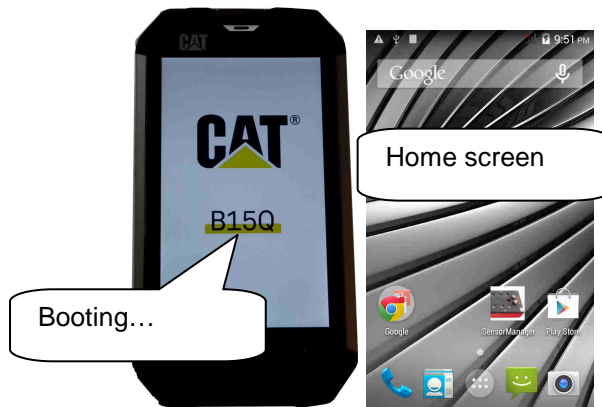

3.3 Set User Interface Language

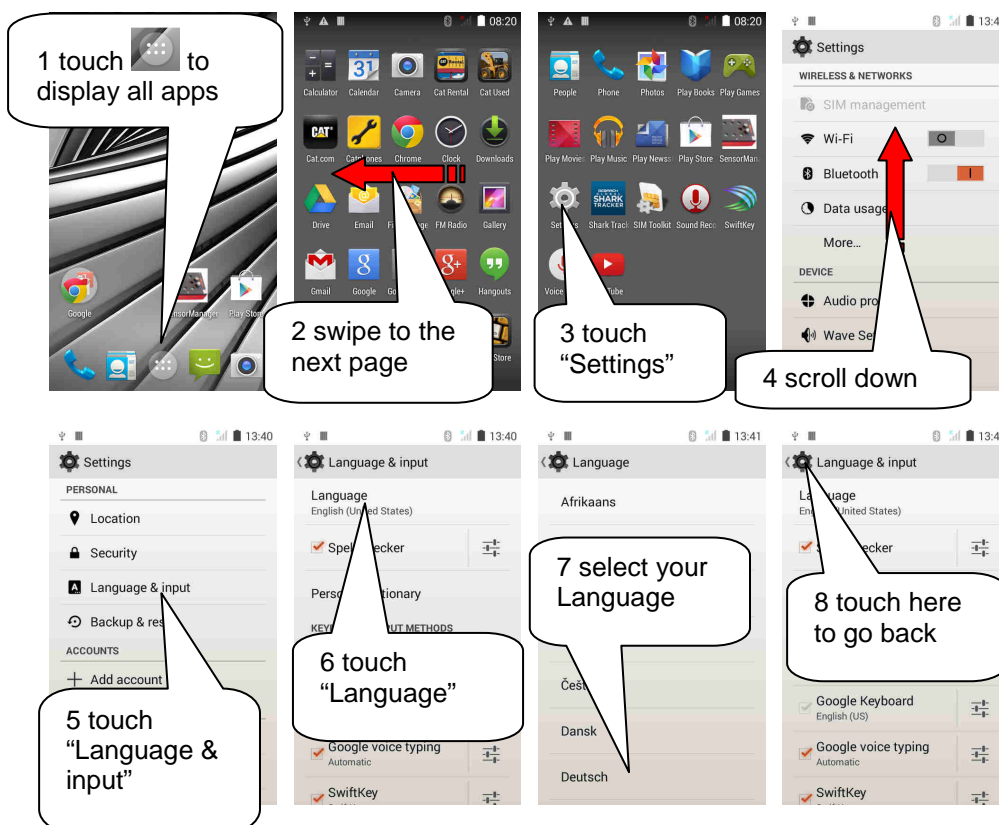

3.4 Set Date & Time

- 1 touch "Date & time"
- 2 touch "Automatic date & time"
- 3 select "Off"
- 4 touch "Set date"
- 5 set date and touch "Done"
- 6 touch "Set time"
- 7 set time and touch "Done"
- 8 uncheck "Automatic time zone"
- 9 touch "Select time zone"
- 10 select your time zone
- 11 Touch the "Home key" to display the home screen
- 12 home screen

4 Start of SensorManager Application

- 1 touch "SensorManager" icon to start the App
- 2 touch "Allow" to turn on Bluetooth
- 3 turning Bluetooth on

Bluetooth Connection Indicator
 GREEN = connected
 RED = disconnected

4.1 Connecting to Sensor Unit

If Android asks for a pairing code for the Sensor then use following Bluetooth pairing code: **hsbt00000**

1 touch "Connect wireless"

2 touch "Scan for devices"

3 select Sensor_XXX

4 connecting to Sensor_XXX

unpaired devices will be shown in "Other Available Devices" list

Bluetooth Connection Indicator
GREEN = connected
RED = disconnected

Volume of current measurement

Start time of actual measurement

4.2 Setting Time & Date of Sensor Unit

1 touch "System Settings"

2 touch "Clock"

3 touch "Set Sensor Clock"

5 confirm with "OK"

6 touch "Check Sensor Clock"
It shows the actual time & date on sensor unit

7 check if the time & date is actual and confirm with "OK"

4.3 Configuration of Drum Diameter

1 select "admin"

2 touch "Login"

3 tap into the password input field to type in

4 type in "0000" as the password

5 confirm with "OK"

6 you are logged in if you can see the "Change password" button

7 touch "Configuration"

8 adjust the drum diameter by scrolling up or down

9 touch "Apply"

10 confirm with "OK"

11 touch the green check to get back into the main menu

$D = U / 3,1415926$

The most accurate way to determine the roll diameter is to measure the perimeter of the drum and acquire the diameter mathematical by dividing with Pi (3,14). The diameter includes the rubber coating of the roll, but does NOT include the conveyor belt.

4.4 Calibration Run

Hint: prior to the start of a new calibration run please ensure that the SensorManager is connected to the sensor!

It has to be ensured, that the EMPTY conveyor belt is running at working speed (sensor has to be in measuring state, red signal lamp is blinking once per second)

The conveyor belt must be clean and free from deposits of feeding material.

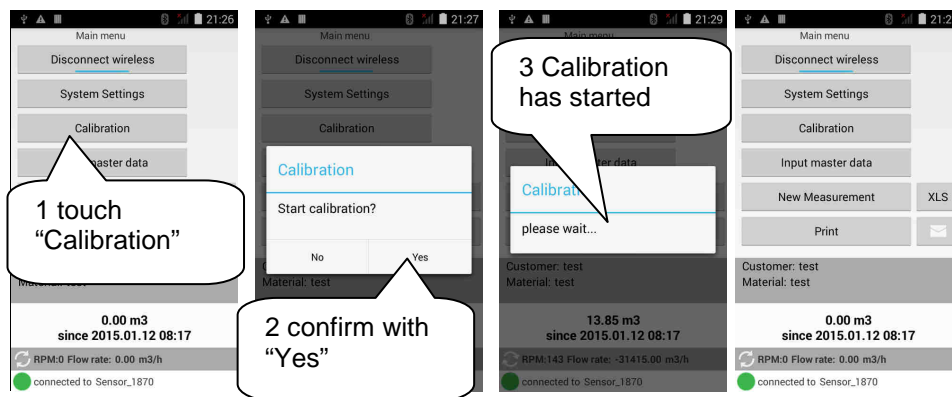

When a calibration run has been started, the red signal lamp starts to flash with fast repetition followed by a short period of steady burning signal lamp. The calibration run is finished when the sensor enters its measuring state with the red signal lamp blinking every second once.

4.5 Input Master Data

If customer or material name are not yet listed in the master data, the data record has to be added.

First of all we have to choose the group in which the new data record is to be added. (Customer or Material)

Now a description can be added to the text field by using the displayed On Screen Keyboard.

By clicking the "Add" button, the new description is added to the list.

We can change back to the main menu by clicking the confirmation symbol in the bottom right corner

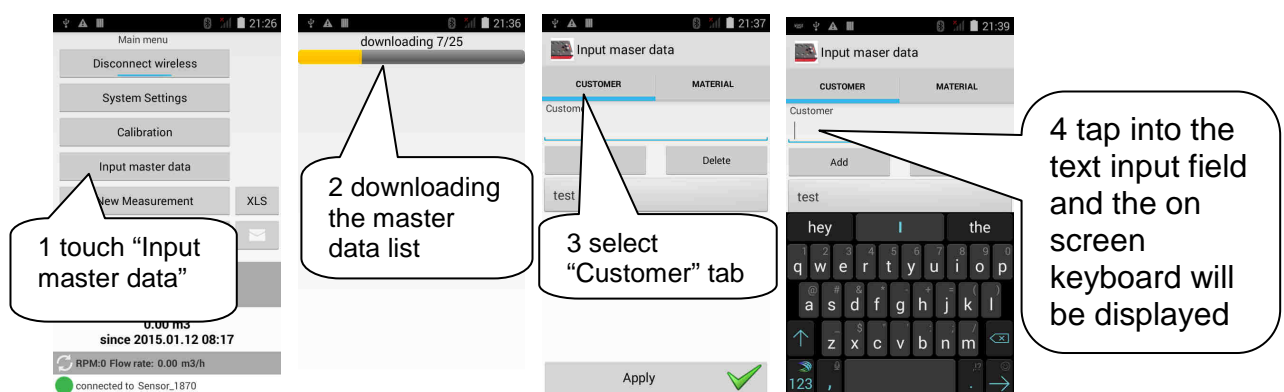

5 type in the customer name

6 select "Add" and touch the back key once to close the on screen keyboard

7 "Customer 1" is added to the list

8 select "Material" tab

9 tap into the text input field

10 type in the material name

11 select "Add" and touch the back key once

12 "Material 1" is added to the list

13 confirm with "Apply"

14 the new master data list is sending to the sensor unit

15 sending is accomplished and you are in the main menu.

4.6 Start New Measurement

To start a new measurement with the new entered customer name and material name you have to select once those and touch the "Start new measurement" button.

1 touch "New Measurement"

2 master data list is downloading

3 select the customer

4 select the material

5 confirm with "Start new measurement"

6 here you can see the configuration of the current measurement

7 displays the start time & the volume of the current measurement

Now the sensor will remember the configuration and will measure the further measurements with this configuration till you changing it.

Hint: Ensure that the measured volume which is displayed on the main menu keeps stable at zero while the empty conveyor belt is running.
 If the m3 value doesn't keep at zero then call the H-Sensortechnik service line.

5 Adjusting

For the measuring adjustment you will need a truck like on the next picture or a container.

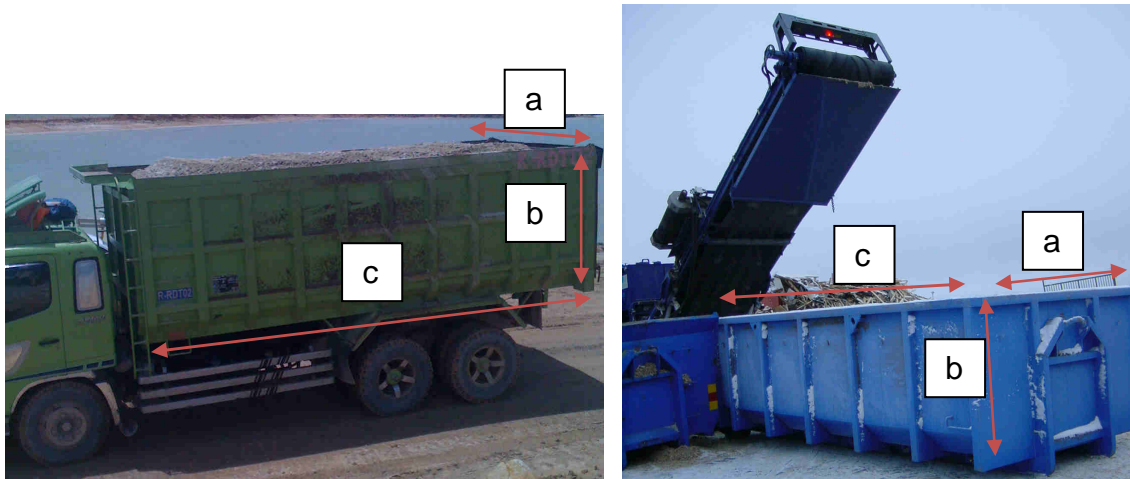

The capacity of the container or the truck must be at least 7m³.
 Measure the distances a, b and c.

Calculate the volume of the container: $V = a * b * c$

5.1 Start test measurement

To ensure a good average of the test you have to **measure 3 times**.

Ensure that you have started a new measurement and the span adjustment factor of the material is set to 100 % and it keeps stable at 0 m3 on a empty running belt.
 (how to set the span adjust see cahpter 5.2)

Start feeding material and fill up the container (truck) till it is full.
 flatten the material in the container. Make sure that the material is not compressed during flattening.

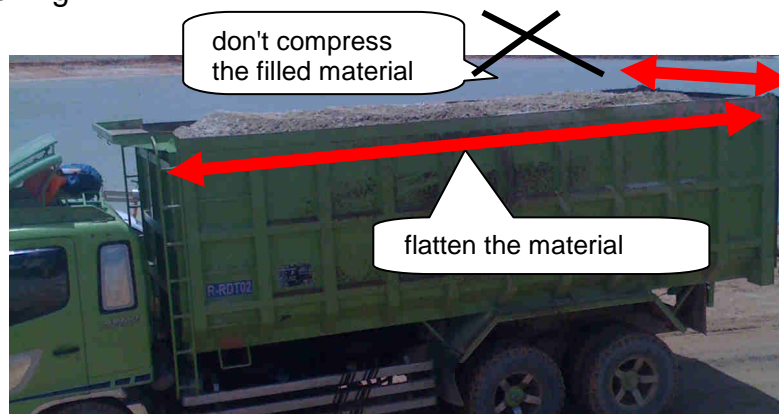

After the known volume of material has run through the sensor and you have measured 3 times, you should have 4 values at hand.

ContainerVolume = the volume of the container

Volume 1 = the value shown on SensorManager after 1st. measurement

Volume 2 = the value shown on SensorManager after 2nd measurement

Volume 3 = the value shown on SensorManager after 3rd. measurement

TotalAverage = average of the 3 measurements.

The average value is calculated using the following formula:

$$TotalAverage [m3] = \frac{(Volume1 + Volume2 + Volume3)}{3}$$

The span adjust factor is calculated using the following formular:

$$span\ adjust\ [\%] = 100 + \frac{(ContainerVolume - TotalAverage)}{(TotalAverage / 100)}$$

Example :

ContainerVolume = 10m³

Volume1=10,34

Volume2=10,30

Volume3=10,2

$$SensorManagerTotalAverage [m3] = \frac{(10,34 + 10,30 + 10,20)}{3} = \frac{30,84}{3} = 10,28m3$$

$$span\ adjust\ factor\ [\%] = 100 + \frac{(10 - 10,28)}{(10,28/100)} = 100 + \frac{-0,28}{0,1028} = 100 - 2,7 = 97,3 \approx 97\%$$

5.2 Setting the span adjust

To enable the span adjust register page, connect to the sensor, go to system settings and login as administrator. Default (factory set) password is "0000".

1 touch „System settings“

2 select „admin“ tab

3 touch „Login“

4 tap into the input field

5 type in the default password: 0000

6 confirm with „OK“

7 long click onto the yellow key icon

8 tap into the input field

8 type in: 4957

9 confirm with „OK“

10 tap into the input field

11 type in 1 to activate

12 confirm with „OK“

13 touch „Main menu“

15 touch „Input master data“

15 scroll to the left by swiping

16 select „SPAN ADJUST“ tab

17 select the material

18 selected material

19 change the value by scrolling up or down

20 touch „Apply“ to confirm the value

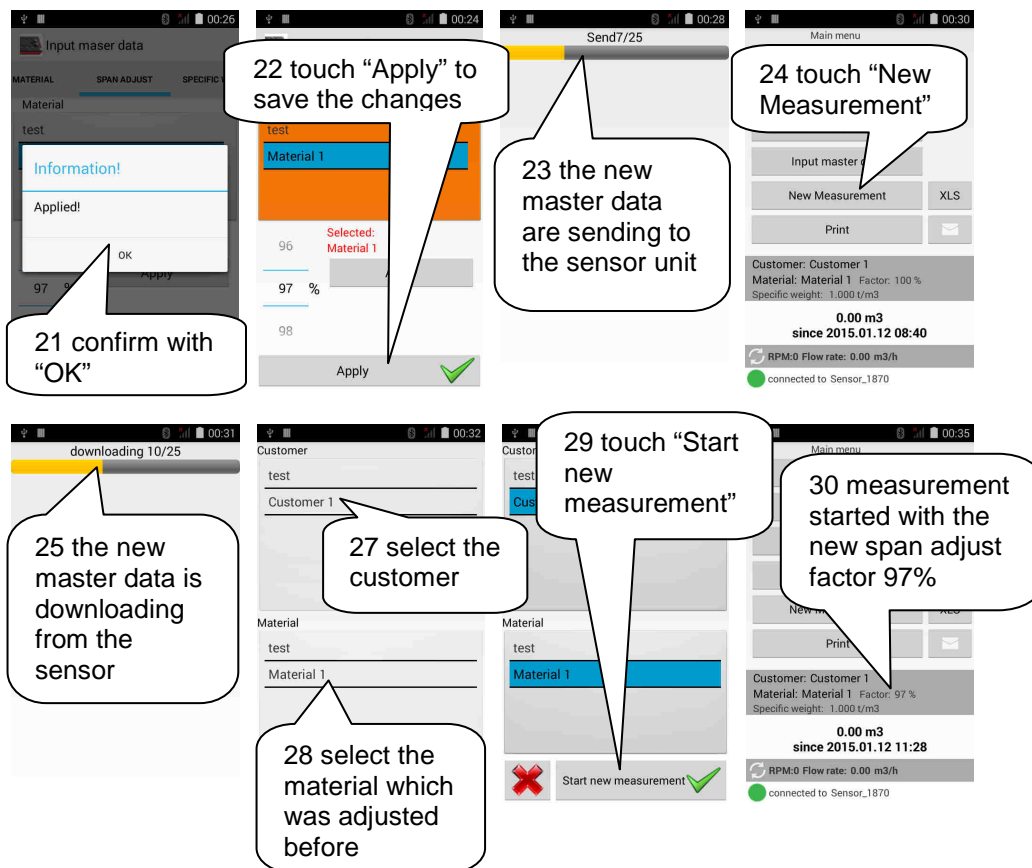

Now you can do a control measurement to check the measured volume. If you have still difference between the measured volume and the real volume, then you have to repeat the adjustment.

These steps must be repeated on every different material.

6 Measurements

6.1 Print measurements

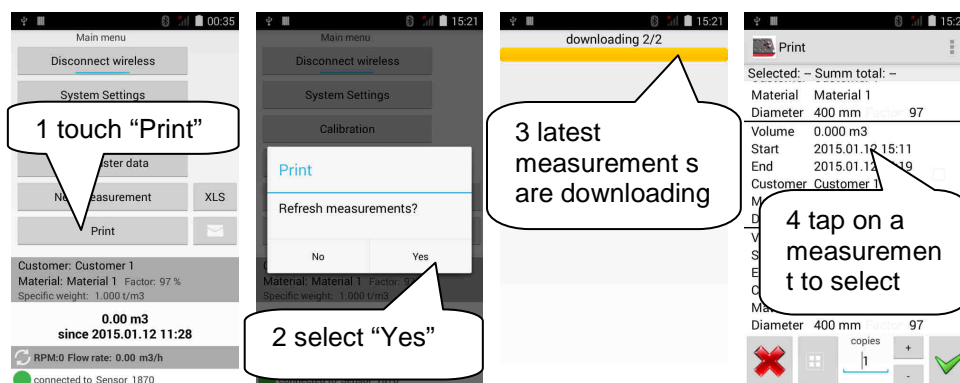

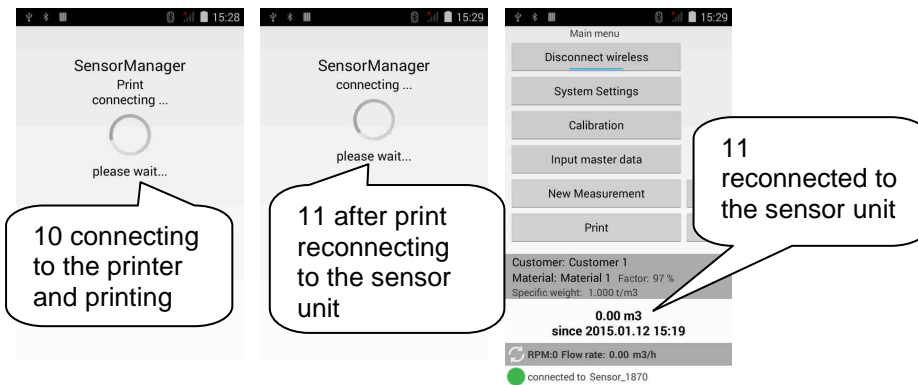
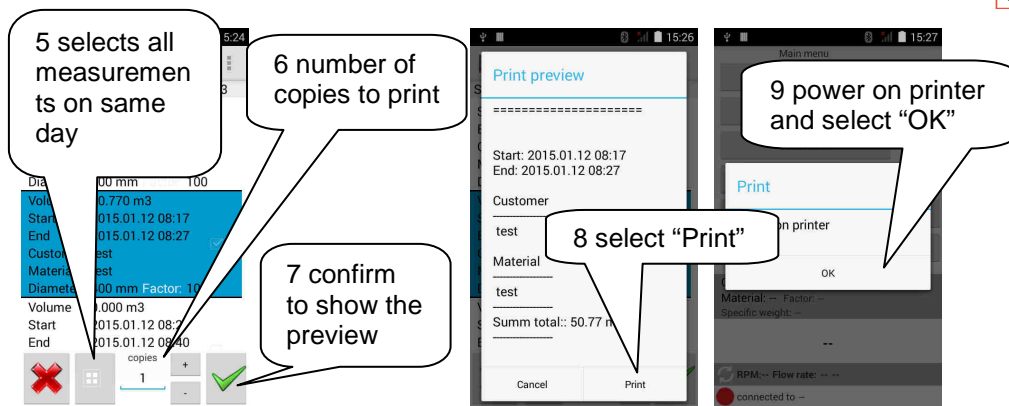

6.2 Print downloaded measurements

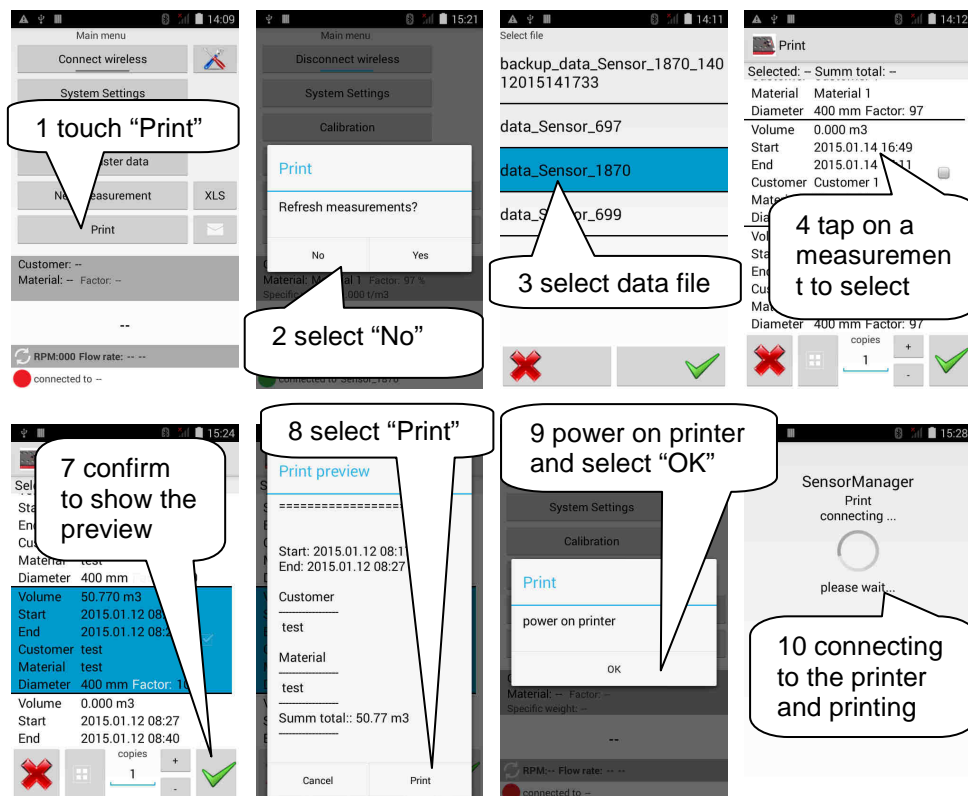

6.3 Send measurements as e-mail attachment

1 touch e-mail button

2 select data file to send

3 confirm

4 select your e-mail app to send. Here Gmail

5 type in recipients e-mail address

data file attached to the e-mail

6 Touch send icon to send

7 Sends e-mail & returns to main menu

6.4 View downloaded measurement as Excel spreadsheet

1 touch XLS button

2 select data file to view

3 confirm

4 select your office app to view XLS-file. Here WPS.

5 select "Just once"

Measurement spreadsheet

Date spreadsheet

6 swipe here to switch to Date view

6.5 Location of exported XLS-File on the mobile phone

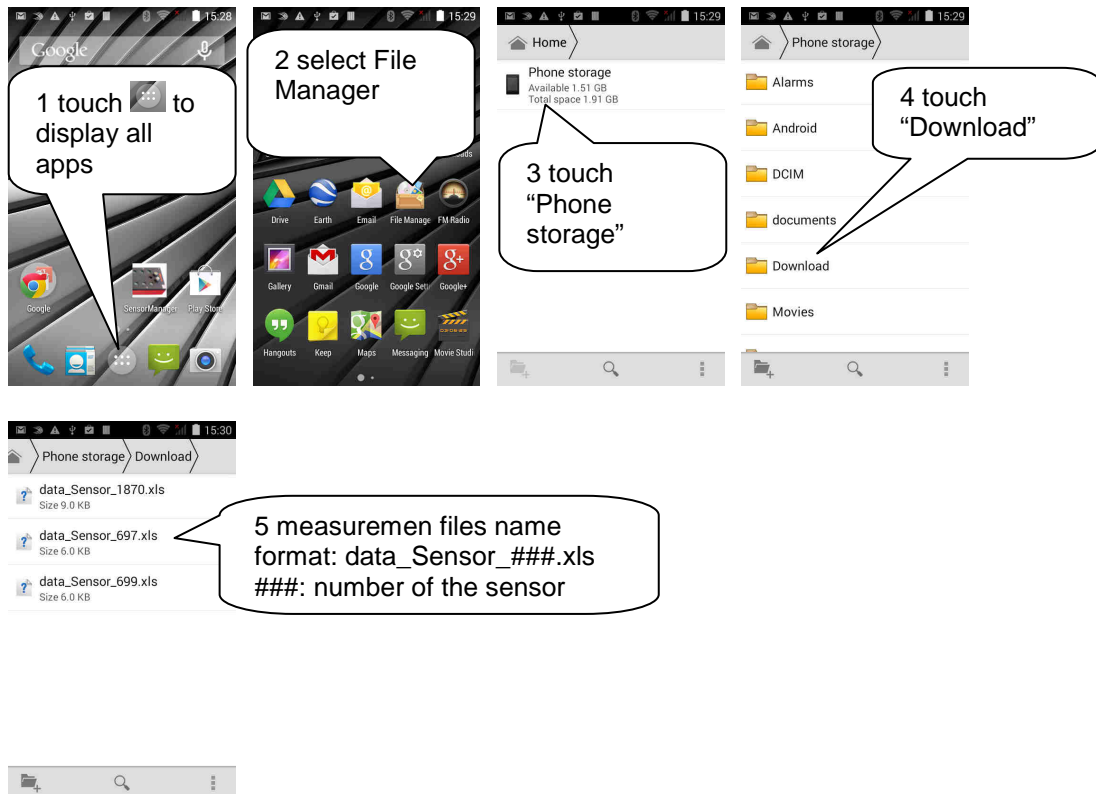

6.6 Copying the XLS-file to your desktop over USB-Cable

1. connect your mobile phone with the supplied usb-cable

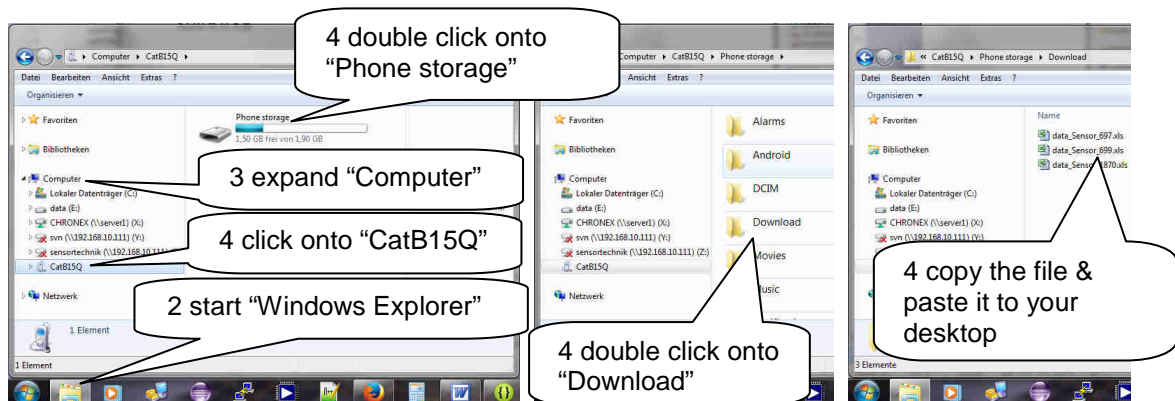

7 System Settings

7.1 Admin(Login/Logout)

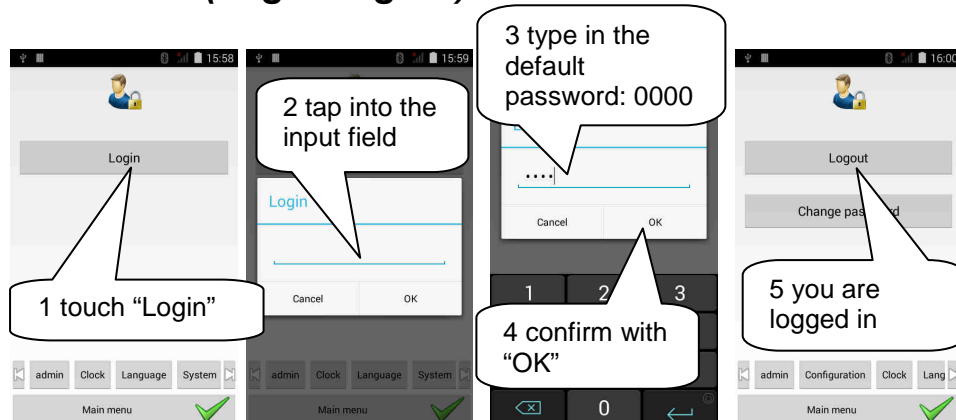

7.1.1 Change Login Password

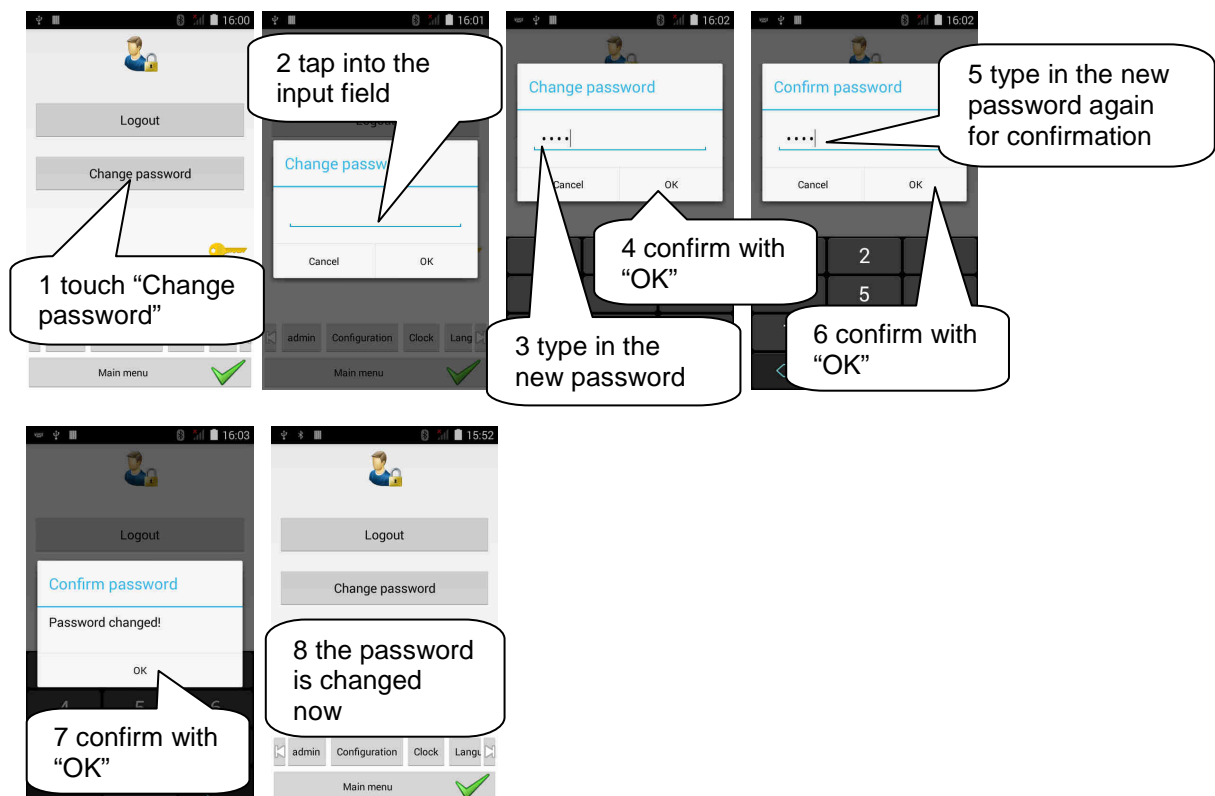

7.2 Configuration

See chapter 4.3

7.3 Clock

See chapter 4.2

7.4 Language

2 touch "Change Language"

1 touch "Language"

2 scroll and select your language. This changes the UI-Language of Android and if your language is not available in SensorManager-App, then English will be used in the App. The UI-Language of Android will be displayed in the selected language.

7.5 Memory

99 %

99% of the memory are still free

1 touch "Memory"

7.5.1 Clear Memory

1 touch "Clear Memory"

2 select "OK"

3 select "OK"

4 touch "Memory"

5 100% free memory is shown

When the memory is cleared a backup file is stored from the data which were downloaded on to the mobile phone.

Hint: Be sure that you have downloaded all measurements before clearing memory!

7.6 Units

2 tap on to the selection list

1 touch "Units"

3 select the unit "t" as an example

4 confirm

6 the spec. weight of the material will be displayed here

5 the unit is now "t"

7.6.1 Setting the specific weight of a material

Be sure that you are logged in!

1 touch "Input master data"

2 scroll to the left by swiping

3 select "SPECIFIC WEIGHT"

4 select the material

5 tap to edit

6 type in the new value

7 touch enter

8 touch "Apply" to confirm

9 touch "OK"

10 touch "Apply" to save

11 data are sending

13 touch "New Measurement"

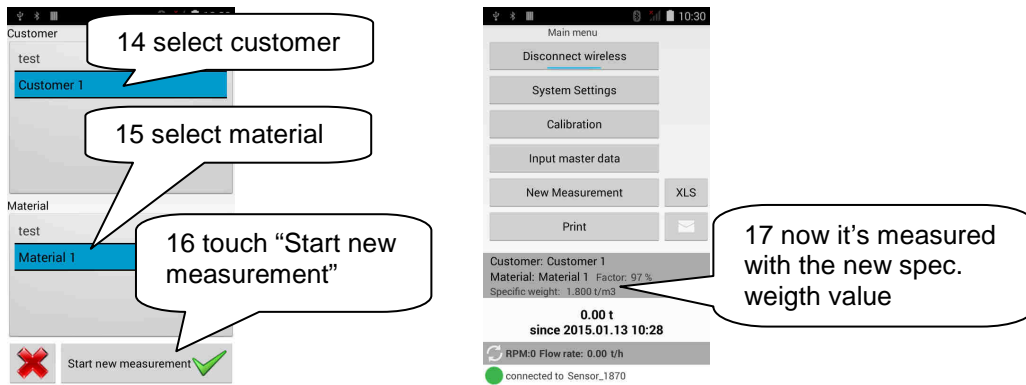

7.7 Print-Settings

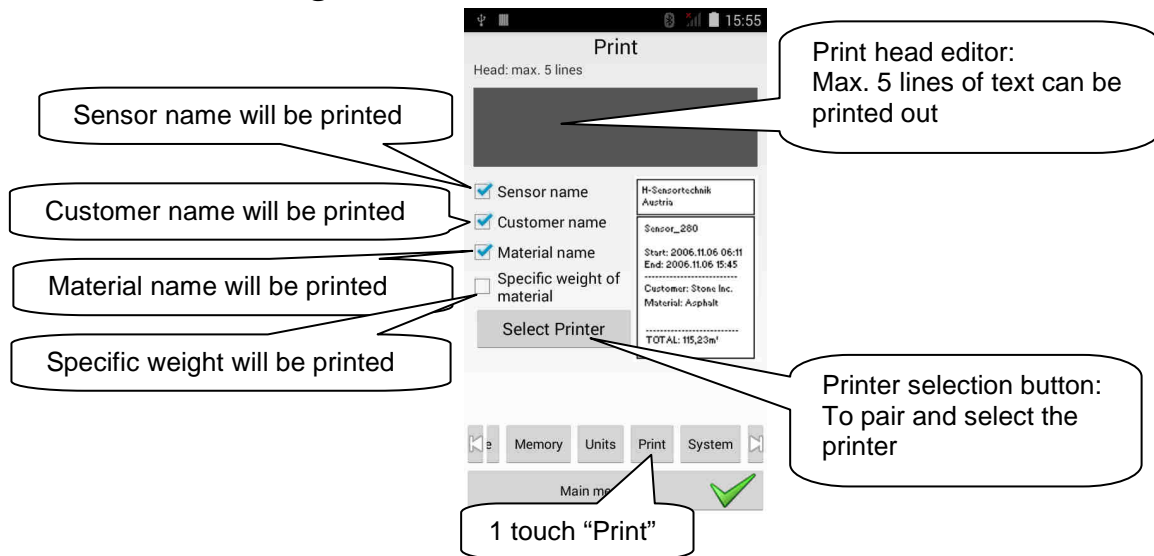

7.8 Pairing & Selecting the printer

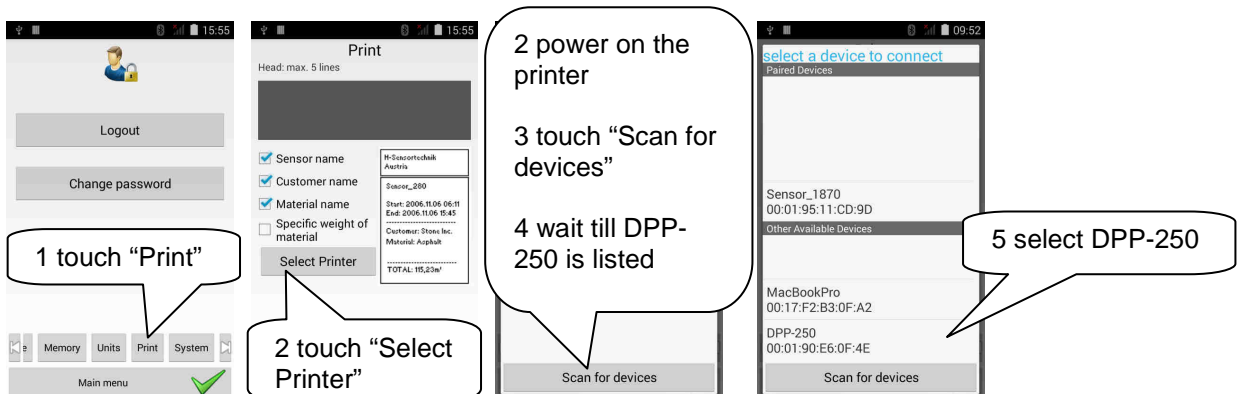

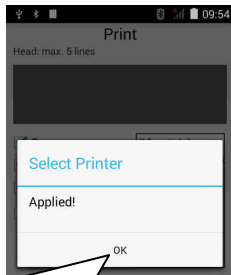

Hint: If a pairing code is requested then use following PIN-code: **0000** for Bluetooth pairing

6 the printer is paired and selected

7.9 System

7.10 Diagnostic report

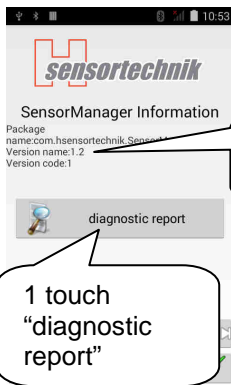

SensorManager version

1 touch "diagnostic report"

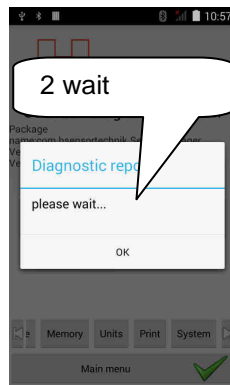

2 wait

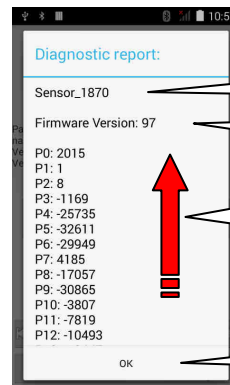

Sensor name

Firmware version

Parameter list. Scroll up to see all values.

3 close with "OK"

8 Thermal Bluetooth Printer



8.1 Loading paper

The DPP-250 uses a drop-and-load design making paper loading easy and trouble free. To load paper, simply lift up the paper cover latch and drop in the new roll as shown in the steps below.

1. Slide the paper cover latch to unlock the paper cover as shown in the figure.
2. Lift the paper cover latch to open the paper cover as shown in the figure.
3. Insert the new roll of thermal paper roll as shown in the figure. Be sure to pull at least 12 mms or more of paper above the top of the printer before closing. Close the paper cover until it snaps lock. Slide paper cover latch to lock the cover in place.

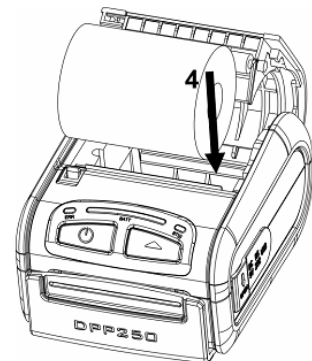

9 Safety Instructions Laser Class

9.1 Laser Class of Device

According to IEC 60825-1 : 2007 the sensor is classified as laser equipment of class 3B.

Invisible laser radiation is emitted.

pulse output	$P_{\max} = 60 \text{ mW}$
pulse duration	$t_{\text{pulse}} = 400 \text{ } \mu\text{s}$
wavelength	$\lambda = 785 \text{ nm}$
pulse repetition rate	$f_{\text{rep}} = 200 \text{ Hz}$

9.2 Warning

**Laser radiation of class 3B is emitted
as soon as the device is working!**

Therefore, the following items must be ensured before starting up the device:

- The sensor may only be started, if it is duly attached at the sensor mounting. Otherwise all persons concerned must wear safety goggles.
- Strip run must not be simulated.
- The optical path must be terminated in case of lack of measuring stock!
- There must not be any reflecting surfaces mounted in the optical path that might lead to reflections! (For optical path see Fig. 5).
- During operation the operating personnel and other persons must not look directly into the emitted beams!
- The safety instructions demanded in the standard for the use of devices of laser class 3B must be complied with.

The following warning signs must be applied at the device:

-
-
-
-
-
-
-
-
-



10 Servicing and cleaning

The sensor is usually service free, only from time to time lenses and windows must be cleaned. They can be cleaned with a cotton cloth.

WARNING!

-

**DO NOT USE A HIGH-PRESSURE CLEANER!
THE SENSOR IS NOT HIGH-PRESSURE PROOF!**

11 Spare parts

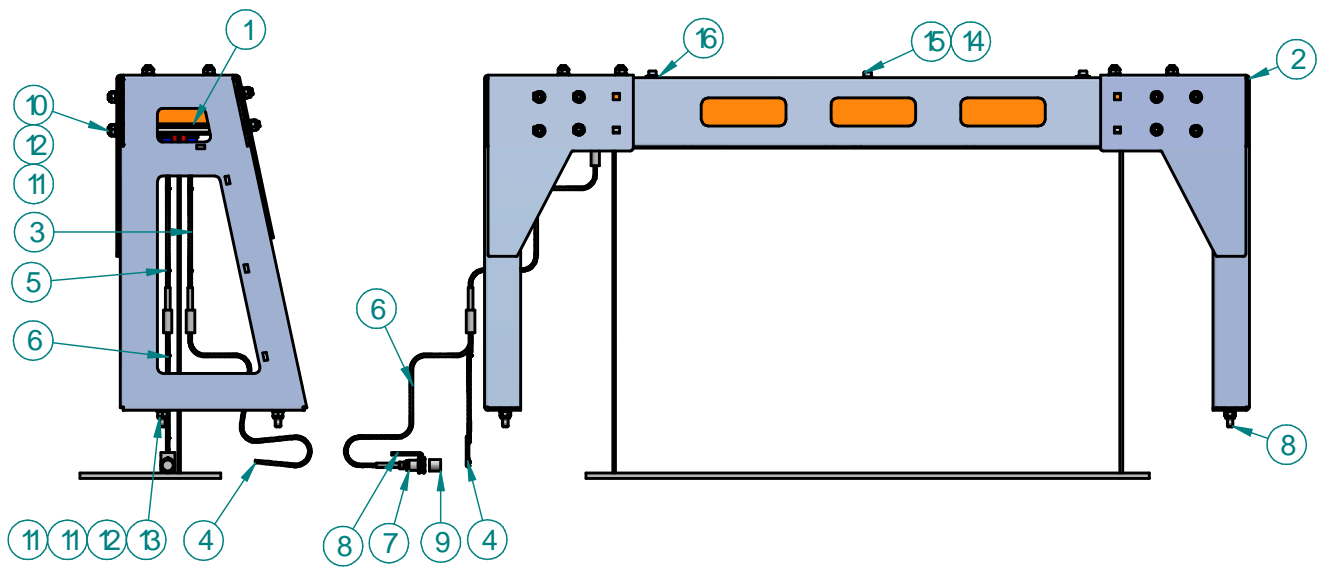

17



18



19



20



21



22

Position	Art. Nr.	Beschreibung
1	150600	Optical Belt Scale S600
1	150800	Optical Belt Scale S800
1	151000	Optical Belt Scale S1000
1	151200	Optical Belt Scale S1200
1	151400	Optical Belt Scale S1400
1	150604	Optical Belt Scale -MultiLink ML600
1	150804	Optical Belt Scale -MultiLink ML800
1	151004	Optical Belt Scale -MultiLink ML1000
1	151204	Optical Belt Scale -MultiLink ML1200
1	151404	Optical Belt Scale -MultiLink ML1400
2	151205	Frame high for 600-800mm
2	150601	Frame high for 1000-1200mm
2	151401	Frame high for 1400-1600mm
2	151203	Frame low for 600-800mm
2	151201	Frame low for 1000-1200mm
2	151206	Frame low for 1400-1600mm
3	110030	Power supply cable 2,5m
3	110130	Power supply cable 2,5m-MultiLink
4	110031	Power supply cable 15m
4	110132	Power supply cable 15m-MultiLink
5	110029	Inductive switch cable 2,5m
6	130007	Inductive switch cable 0,5m
7	130017	Inductive switch
8	130015	Holder for inductive switch
9	130022	Indicator for inductive switch
10	110077	Cup square neck bolt DIN603 8.8-M10x25 galvanized
11	110080	Spring washer DIN137B M10 waved, galvanized
12	110078	Hexagon nut DIN982 Kl.8 M10 galvanized
13	110076	Hexagon head screw DIN933 8.8-M10x35 galvanized
14	110079	Spring washer DIN137A M8 galvanized
15	110075	Hexagon socket head cap screw DIN912 -M8x20 galvanized
16	110143	Large diameter washer 8,4x30x1,5 A2, stainless
17	140000	Mobile Handheld
18	140007	Car-USB-Charger for Handheld 12V und 24V
19	140001	Bluetooth thermo printer
20	120008	Paper roll for printer
21	130019	DC/DC converter 12V -> 24V
22	130020	AC/DC converter 230V -> 24V
23	110081	User manual

Contact:

H-Sensortechnik GmbH

Oberer Markt 3 · A – 4332 Au/Donau

Tel: +43 (0) 7262 54655-0 DW Fax 90

mail: office@h-sensortechnik.com · www.h-sensortechnik.com

12 Connector & Cable Configurations

12.1 Power supply connector on Sensor

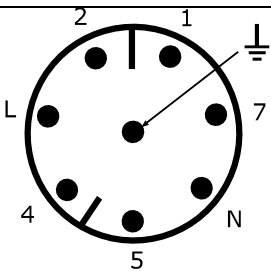

A circular pinout diagram for a 7-pin connector. The pins are arranged in a circle with a central ground pin. The pins are labeled: 1 (top), 2 (top-left), 4 (left), 5 (bottom), N (bottom-right), 7 (right), and a ground symbol (bottom-left).

Pin #	Signal	Signal direction	Signal Info
1	Power supply 0 VDC (GND)	GND	GND internal connected to housing via reverse battery protection diode
2	Power supply +24 VDC	input	+24VDC +- 20%, I _{max} = 3,5A
L	Not connected	n.c.	n.c.
4	RS-422 / Bluetooth mode selector	input	"high" +24 VDC = RS-422 mode "low" 0V = Bluetooth mode
5	RS-422 sensor out -	differential output	Use only in RS-422 mode
N	RS-422 sensor out +	differential output	Use only in RS-422 mode
7	RS-422 sensor in +	differential input	Use only in RS-422 mode
⏏	RS-422 sensor in -	differential input	Use only in RS-422 mode

12.2 Inductive switch connector on Sensor

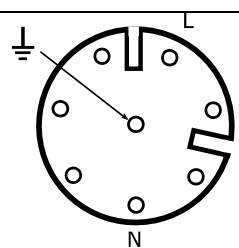

A circular pinout diagram for a 3-pin connector. The pins are arranged in a circle with a central ground pin. The pins are labeled: L (top), N (bottom), and a ground symbol (left).

Pin #	Signal	Signal direction	Signal Info
L	+12 VDC	out	Power supply inductive switch
N	Signal	in	Signal receive from inductive switch
⏏	0 VDC	out	Power supply inductive switch

12.3 Power supply cable 2.5m

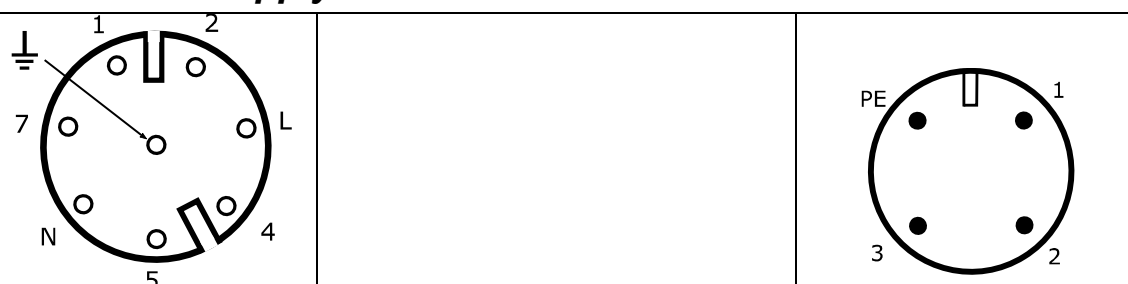

Two circular pinout diagrams for a 5-pin connector. The left diagram shows the sensor side with pins 1, 2, L, 4, 5 and a ground symbol. The right diagram shows the cable side with pins 1, 2, 3, PE.

Pin #	Signal	Lead color	Pin #
1	0 VDC (GND)	blue	2
2	+24 VDC	brown	1
L	Not connected		PE
4	Not connected		
5	Not connected		

N	Not connected		
7	Not connected		
⏏	Not connected		

12.4 Power supply cable 15m

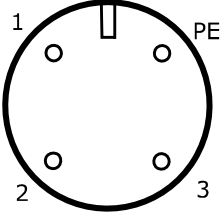
		
Pin #	Signal	Lead color
1	+24 VDC	brown
2	0 VDC (GND)	blue
PE	Not connected	

12.5 Inductive switch cable 2.5m

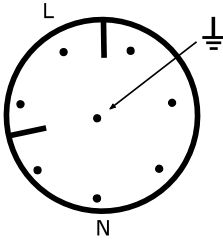
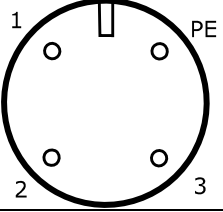
			
Pin #	Signal	Lead color	Pin #
L	+12 VDC	Brown	1
⏏	0 VDC	White	2
N	Signal	Yellow	3
	Not connected		PE

12.6 Inductive switch cable 0.5m

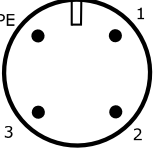
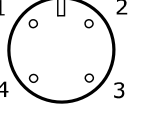
			
Pin #	Signal	Lead color	Pin #
1	+12 VDC	Brown	1
2	0 VDC	Blue	2
3	Signal	Black	4
PE	Not connected		3

12.7 Inductive switch

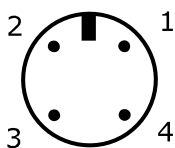
		
Pin #	Signal	
1	+12 VDC	
2	0 VDC	
3	Not connected	
4	Signal	

12.8 Data cable 3m

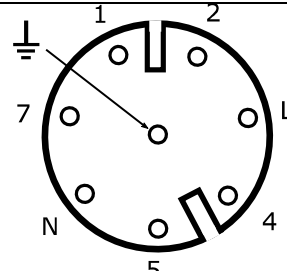
				
Pin #	Signal	Signal direction	Signal Info	Lead color
1	Power supply 0 VDC (GND)	GND	GND internal connected to housing via reverse battery protection diode	Brown & white
2	Power supply +24 VDC	input	+24VDC +- 20%, I _{max} = 3,5A	red
L	Not connected	n.c.	n.c.	n.c.
4	RS-422 / Bluetooth mode selector	Input	"high" +24 VDC = RS-422 mode "low" 0V = Bluetooth mode	blue
5	RS-422 sensor out -	Differential output	Use only in RS-422 mode	gray
N	RS-422 sensor out +	Differential output	Use only in RS-422 mode	pink
7	RS-422 sensor in +	Differential input	Use only in RS-422 mode	Green
⊥	RS-422 sensor in -	Differential input	Use only in RS-422 mode	yellow

13 Drawings

