

23

# KABELSCHUTZ SYSTEME

## CABLE PROTECTION SYSTEMS

Gesamtkatalog  
Main catalogue

[www.flexa.de](http://www.flexa.de)



## INTELLIGENTE LÖSUNGEN VON PROFIS FÜR PROFIS. INTELLIGENT PROFESSIONAL SOLUTIONS FOR PROFESSIONALS.

### KABELSCHUTZSYSTEME MADE IN GERMANY.

Wir entwickeln und produzieren Kabelschutz mit passender Anschlusstechnik in Deutschland.

- Schutzschlauch Systeme aus Metall und Kunststoff individuell für Ihre Anforderungen.
- Führungsketten-Systeme mit einer langen Lebensdauer für einfache und schwere Anwendungen bei einfacher Handhabung mit handelsüblichen Werkzeugen.
- Kabeldurchführungssysteme, um viele Kabel und Leitungen auf engstem Raum in Maschinen oder Steuerungsschränke zu führen.
- Absaug-, Gebläse- und Förderschlauchsysteme aus Metall, Kunststoff und Gewebe.

UNSERE HOCHWERTIGEN PRODUKTE  
ERFÜLLEN HOHE STANDARDS UND HABEN  
WELTWEITE ZULASSUNGEN

### CABLE PROTECTION SYSTEMS MADE IN GERMANY.

We develop and produce cable protection devices including the corresponding connectors in Germany.

- Metal and plastic conduit systems, made to match your individual requirements.
- Guide chain systems designed for extended lifetime for standard and heavy applications, simply handling with standard tools.
- Cable entry systems to feed cables and wires into machines or into control cabinets in a confined space.
- Suction, blower and transport hose systems made of metal and plastics.

OUR QUALITY PRODUCTS MEET  
HIGHEST STANDARDS AND HAVE  
RECEIVED WORLDWIDE APPROVALS

**IRIS**  
Certification



			SEITE PAGE
<b>01</b>	Firmenportrait	Company portrait	2 – 5
	Produktübersichten	Product guide	6 – 21
	Produkt-Auswahlkriterien	Product selection criteria	16 – 17
<hr/>			
<b>02</b>	<b>ROHRflex® Wellschläuche</b>	<b>ROHRflex® tubings</b>	
	ROHRflex® PA 6   PA 12   Sonstige	ROHRflex® PA 6   PA 12   further	2 – 18
	Kabelsammler ROHRflex® Multi	Cable buncher ROHRflex® Multi	19
	ROHRflex®-Duo teilbar	ROHRflex®-Duo, separable	20 – 21
	FLEXAzip® - ROHRflex® PA geschlitzt	FLEXAzip® - slitted ROHRflex® PA	22
Werkzeuge	Tools	23	
<hr/>			
<b>03</b>	<b>Verschraubungen FLEXAquick®</b>	<b>Connectors FLEXAquick®</b>	
	Gerade und Winkel   Bogen Spezialzubehör   Haltersysteme	Straight connectors   elbows   bends Special accessories   tubing clamps	2 – 39 40 – 56
<hr/>			
<b>04</b>	Metallschutzschläuche	Protective metal conduits	2 – 9
<hr/>			
<b>05</b>	Metallschutzschläuche flüssigkeitsdicht	Protective metal conduits liquid tight	2 – 15
<hr/>			
<b>06</b>	Kunststoffschutzschläuche	Protective plastic conduits	2 – 9
<hr/>			
<b>07</b>	<b>Spezialschutzschläuche</b>	<b>Special protective conduits</b>	
	Geflechtschläuche	Braidings	2 – 6
	Sensorschläuche	Sensor conduits	7 – 10
	PS-Schläuche	PS conduits	11
	FLEXAspiral - Bündelungsspiralen	FLEXAspiral - spiral bindings	12 – 13
FLEXAhightemp Feuerschutz System	FLEXAhightemp fire protection system	14 – 15	
<hr/>			
<b>08</b>	<b>Verschraubungen</b>	<b>Connectors</b>	
	Metall	Metal	2 – 25, 28 – 31
	Kunststoff	Plastics	26 – 27
	Spezialzubehör   Dichtringe, Tüllen	Special Accessories   sealings, sleeves	32 – 36
Werkzeuge	Tools	37	
<hr/>			
<b>09</b>	Zubehör	Accessories	2 – 25
<hr/>			
<b>10</b>	Kunststoff-Führungsketten	Plastic guide chains	2 – 18
	Rinnensystem	Channel system	19 – 22
	Technische Informationen	Technical data	23 – 27
<hr/>			
<b>11</b>	Kabeldurchführungssysteme	Cable entry systems	2 – 10
<hr/>			
<b>12</b>	Technische Daten	Technical information	2 – 21
	Artikel-Nummer Verzeichnis	Article number index	22 – 25
	Allgemeine Lieferbedingungen	General terms of delivery	28 – 31
	Repräsentanten	Agents and distributors	32 – 33

## Flexibilität und Produktvielfalt.

Flexibility and a wide product range.



### WIR VERBINDEN TRADITION MIT MODERNE.

1947 gegründet, vereinen wir Jahrzehnte der Expertise mit zeitgemäßem Know-how. Unser Entwicklungsteam hegt den Ansporn, immer wieder ein entscheidendes Stück voraus zu sein. So sind unsere Produkte stets am Puls der Zeit. Fortschritt ist unsere tägliche Motivation, und die Zufriedenheit unserer Kunden die schönste Bestätigung unserer Arbeit.

### WE COMBINE TRADITION WITH MODERN AGE.

Founded in 1947, we can today combine decades of experience with up-to-date expertise. Our Development team strives permanently to stay ahead of the competition to keep our products in step with the times. Progress is our everyday motivation, and customer satisfaction is the most rewarding response for us.

### UNSERE PRODUKTPALETTE SETZT MASSSTÄBE.

Ganz gleich, welches Kabelschutzsystem Sie benötigen – bei uns erhalten Sie die optimale Lösung aus einer Hand. Wir bieten Leitungsschutz aus Kunststoff oder Metall inklusive passender Anschlusskomponenten in allen gängigen Gewindeformen. Unsere Produkte sind lösungsmittelresistent, flüssigkeitsdicht, UV-beständig, mit Kunststoff ummantelt oder haben eine Stahldrahtumflechtung. Zudem sind sie Temperaturen von  $-60^{\circ}\text{C}$  bis  $+600^{\circ}\text{C}$  gewachsen, abgestuft bis zur IP-Klasse 69K. Unsere Kabelschutzsysteme schirmen Datenleitungen vor elektromagnetischen Einflüssen ab und schützen Laserlichtwellenleiter vor Beschädigung. Im klinischen Bereich entsprechen sie strengsten Ansprüchen an Hygiene und sorgen für einfache Desinfizierbarkeit.

Damit kann unser Portfolio den unterschiedlichsten Einsatzbereichen Rechnung tragen – ob im Maschinen- oder Fahrzeugbau, im Schienen- oder Flugverkehr, bis hin zu Windkraftanlagen und Medizin. Kabelschutzsysteme aus dem Hause FLEXA sind in technischen Anlagen auf der ganzen Welt zu finden.

### OUR PRODUCT RANGE SETS STANDARDS.

No matter which protective tubing system you require – we can supply the ultimate solution from one source. We offer cable protection devices made of plastics or metal including the appropriate connectors featuring any customary type of thread. Our products are liquid-tight, resistant to solvents and UV light, or coated with silicone. They can be applied at temperatures of between  $-60^{\circ}\text{C}$  and  $+600^{\circ}\text{C}$  and are approved for up to IP 69K. Our cable protection systems protect data lines against electromagnetic impacts and safeguard laser-optical wave guides against physical damage. In a clinical setting, they meet strictest hygienic requirements and are easy to sterilize.

So our portfolio covers manifold applications in mechanical engineering, automotive, rail traffic, aviation or even in wind power stations or in the medicine sector. Protective tubings made by FLEXA are applied in technical plants all over the world.

## Sicherheit durch Qualität. Safety based on quality.

### ZUVERLÄSSIGKEIT SCHAFFT VERTRAUEN.

Qualität ist von jeher Credo unseres Unternehmens. Ein spezielles Team ist mit dieser Aufgabe betraut und prüft in unserem hauseigenen Testlabor alle Produkte regelmäßig auf Herz und Nieren. Zusätzlich zu Standardverfahren wie Zugversuchen, Dauertests oder solchen in puncto Lösungsmittelbeständigkeit nehmen wir unsere Produktionsprozesse auch immer wieder stichprobenhaft unter die Lupe.

Das Qualitätsmanagement ist bei FLEXA nach DIN EN ISO 9001 zertifiziert. Zudem absolviert jeder Mitarbeiter mindestens einmal im Jahr eine entsprechende Weiterbildung. Qualität ist fester Bestandteil unserer Arbeitsprozesse. So ist auf konstantes Fertigungsniveau ebenso Verlass wie auf die Einhaltung kundenspezifischer Vorgaben.



VIDEO  
D



VIDEO  
EN

### RELIABILITY CREATES TRUST.

Quality has always been our credo at FLEXA. An entire team is entrusted with quality assurance and regularly checks all our products thoroughly in our own test lab. In addition to the standard test procedures such as tensile tests, endurance tests, or tests on solvent resistance, we also carry out random tests on our production processes.

Quality management at FLEXA is certified as per DIN EN ISO 9001. Moreover, every member of staff is subjected to corresponding further training at least once a year. The focus on quality is a firmly integrated part of our work processes. Therefore, you can count on a permanent high quality level of our products as well as on the fact that we will fully meet your customer-specific requirements.



### INNOVATIVER MASCHINEN- UND ANLAGENPARK.

Unsere Produktionsanlagen sind „state-of-the-art“ und gewährleisten rundum gleichbleibende Qualität. Neben der Verarbeitung von Metall und Kunststoff verfügen wir über umfassende Erfahrung im Umgang mit Silikon. Unser Maschinen- und Anlagenpark ist den unterschiedlichsten Anforderungen gewachsen und damit so individuell wie die Wünsche unserer Kunden.

- Schlauch-Vollautomaten
- Spulautomaten
- Extruder
- Wendelwickelmaschinen
- Stangenhaltautomaten
- Drahtwendelmaschinen
- Flechtmaschinen
- Well Schlauchanlagen
- Schlauchautomaten
- Spritzgussmaschinen

### INNOVATIVE MACHINERY.

Our production plant is equipped with state-of-the-art machines and ensures constant superior quality levels. Our expertise is not limited to metal and plastic processing only but also allows us to process silicone professionally. Our machinery is capable of meeting most diverging requirements and is thus as individual as the requests submitted by our customers.

- Fully automatic tubing machines
- Automatic winders
- Extruders
- Spiral winding machines
- Semi-automatic bar machines
- Wire winding machines
- Braiding machines
- Production plant for corrugated tubes
- Hose production machines
- Injection moulding machines



Vorsprung dank Individualität.  
Lead based on individuality.



**BEDARFSGERECHTE LÖSUNGEN NACH MASS.**

Bei FLEXA gibt es weit mehr als Kabelschutzsysteme von der Stange. Schließlich erfordern manche Einsatzgebiete spezielle Anpassungen. Unsere Entwicklungsingenieure stellen sich mit Know-how und persönlichem Ehrgeiz jeder Herausforderung und treiben anwendungsspezifisches Produktdesign für unsere Kunden voran. So sind wir in der Lage, mit Hilfe modernster CAD-Anlagen maßgeschneiderte Lösungen in 3D zu konzipieren. Natürlich bauen wir diesen Vorsprung kontinuierlich aus. Dazu investieren wir einen erheblichen Teil des Jahresumsatzes in Erweiterung und Instandhaltung unserer Produktionsanlagen sowie in die Schulung qualifizierten Personals.

**CUSTOMIZED SOLUTIONS IN LINE WITH DEMAND.**

FLEXA offers a lot more than just standardized protective tubing systems. After all, some application fields require special adaptations. Our experienced and ambitious development engineers accept any challenge and are eager to push ahead application-specific product engineering for the benefit of our customers. This drive, as well as our latest CAD equipment, allows us to design customized solutions in 3D. Of course, we are constantly striving to stretch our lead, also by investing a considerable portion of our annual turnover in the extension and maintenance of our machinery as well as in further training for our competent personnel.



**EIGENER WERKZEUGBAU FÜR EIN PLUS AN FLEXIBILITÄT.**

In hauseigenen Werkstätten stellen wir bedarfsgerechtes Sonderwerkzeug her. Was den cleveren Köpfen unserer Entwicklungsabteilung entspringt, nimmt hier als Prototyp Gestalt an und wird anschließend im Testlabor kritischen Prüfungen unterzogen. Für unsere Kunden bedeutet dies ein Höchstmaß an Flexibilität, wenn es darum geht, nutzerspezifische Lösungen bereitzustellen. Frei nach dem Motto – „darf’s ein bisschen mehr sein?“

**OWN TOOL PRODUCTION FOR ENHANCED FLEXIBILITY.**

We run our own workshops to be able to create special tools as needed. So whatever originates from the clever minds of our Development team, it is converted into a prototype here and then thoroughly tested in our lab. This advantage provides utmost flexibility towards our customers as we are perfectly able to supply any user-specific solution.

## Verantwortung und Nachhaltigkeit. Responsibility and sustainability.

### UMWELTSCHUTZ IST EIN STÜCK ZUKUNFT.

Schon vor Jahren haben wir uns zu freiwilligen Maßnahmen zum Wohle des Umweltschutzes verpflichtet. So minimieren wir stetig die Mengen an Abfall und achten bei der Auswahl der Rohstoffe auf recyclebares Ausgangsmaterial. Ein speziell auf unsere Produktionsverfahren zugeschnittenes Entsorgungsprogramm hält die ökologische Belastung auf niedrigstem Niveau. Sorgsamer Umgang mit Ressourcen und bewusstes Handeln im Sinne der Nachhaltigkeit sind für uns ganz selbstverständlich.

### ENVIRONMENTAL PROTECTION AS INTEGRAL PART OF OUR FUTURE.

Already years ago we voluntarily committed ourselves to protecting the environment with appropriate measures. Therefore, we are constantly reducing our waste and make sure we select our raw material under recyclability-oriented aspects to the greatest possible extent. We are proud of our waste disposal scheme customized for our production processes and thus stress the environment as little as possible. We regard the reasonable use of resources and permanent awareness in terms of sustainability as a matter of course.



### PARTNERSCHAFT VORLEBEN UND LEBEN.

Als Unternehmen stellen wir uns der Verantwortung auch in ganz menschlicher Hinsicht. Wir sind Ausbildungsbetrieb aus Überzeugung und fördern unsere Mitarbeiter im Zuge zahlreicher Weiterbildungsangebote. Konstruktive Vorschläge sind jederzeit willkommen. Wir verstehen die kontinuierliche Optimierung von Arbeitsprozessen als gemeinschaftliche Aufgabe, die den Zusammenhalt unseres Teams ebenso fördert wie die Motivation jedes Einzelnen. Über die Hälfte unserer Mitarbeiter sind inzwischen länger als zehn Jahre an Bord. Im Hause FLEXA wird Partnerschaft aktiv gelebt – und genauso an unsere Kunden weitergegeben. Vielleicht unser Erfolgsgeheimnis ...



### SETTING AN EXAMPLE OF PARTNERSHIP AND WALKING THE TALK.

As an enterprise, we are also willing to accept responsibility in human terms. We are a training company out of conviction and are pleased to further develop our staff with comprehensive ongoing education. Constructive suggestions are always appreciated at FLEXA. We regard continuous optimization of work processes to be a joint task which, on the one hand, strengthens cohesion among the team members and, on the other hand, also boosts the individual's commitment. More than 50% of our staff have been with us for more than 10 years. We at FLEXA actively set an example of partnership – and also involve our customers in this partnership. Perhaps, this is our secret of success ...

## ROHRflex® WELLSCHLÄUCHE MIT FLEXAquick® ANSCHLUSSTECHNIK ROHRflex® TUBINGS WITH FLEXAquick® CONNECTORS



**PA 6**  
Standard, für nahezu alle Anwendungen  
standard, for almost all applications



**PA 6-D**  
dickwandig, für schwere Anwendungen  
thick walled for heavy applications



**PA 6-S**  
geringerer Brandschutz für einfache Anwendungen  
reduced fire protection for simple applications



**PA 6-L|PA 6-LL**  
geringerer Brandschutz wirtschaftlich  
reduced fire protection economical



**PA 6-HT**  
für hohe Temperaturen  
for high temperatures

Seite | page 02.2

02.3

02.4

02.5

02.8

Zulassungen Recognition					
Abmessung AD Size range OD	10 – 54,5	10 – 54,5	10 – 54,5	10 – 54,5	10 – 54,5
Material Material	Polyamid 6 Polyamide 6	Polyamid 6 Polyamide 6	Polyamid 6 Polyamide 6	Polyamid 6 Polyamide 6	Polyamid 6 Polyamide 6
Temperaturbereich Temperature range	-40° C ... +120° C	-40° C ... +120° C	-40° C ... +120° C	-25° C ... +120° C	-25° C ... +150° C
Schutzart Protection class	IP 68   69K	IP 68   69K	IP 68   69K	IP 68   69K	IP 68   69K
Brandklasse Flammability class	V0 [UL 94]	V0 [UL 94]	V2 [UL 94]	HB [UL 94]	V2 [UL 94]
<b>Anwendungsgebiete Applications</b>					
Maschinen-   Anlagenbau Machine   Plant Construction	✓	✓	✓	✓	✓
Schienenfahrzeuge Railway Industry	✓	✓	✓	-	-
Fahrzeugbau Automotive	✓	✓	✓	✓	✓
Schiffsbau Shipbuilding	✓	✓	✓	✓	-
Automation Automation	✓	✓	✓	✓	-
Elektroanlagen Electrical Installations	✓	✓	✓	✓	✓
ATEX, EX Bereich ATEX, ex area	-	-	-	-	-

- P PG Gewinde
- M Metr. Gewinde
- C CTG-Gewinde
- N NPT-Gewinde
- U UNEF-Gewinde

- P PG thread
- M metric thread
- C CTG thread
- N NPT thread
- U UNEF thread

ANSCHLUSSTECHNIK | CONNECTORS



RQG-M|P|C|N  
03.6-7



RQ GK-M|P  
03.8



RQG1-M|P|C|N  
03.9-10



RQLG1-M|P|N  
03.11



RQGKZ[P]-M|P  
03.12-14



RQGKZE-M  
03.15



RQGKZED-M  
03.16



RQGZ-M|P|N  
03.17



RQGZ1-M|P|N  
03.18



RQG2-M|P|N|U  
03.19-20



RQGK2-M|P  
03.21



RQG3-M|U  
03.22



RQGZ-S  
03.23



RQG1-S  
03.23



RQGST-M  
03.24



RQG-Duo-M  
03.25



RGE-M  
03.26



RQB90-M|P|N  
03.27



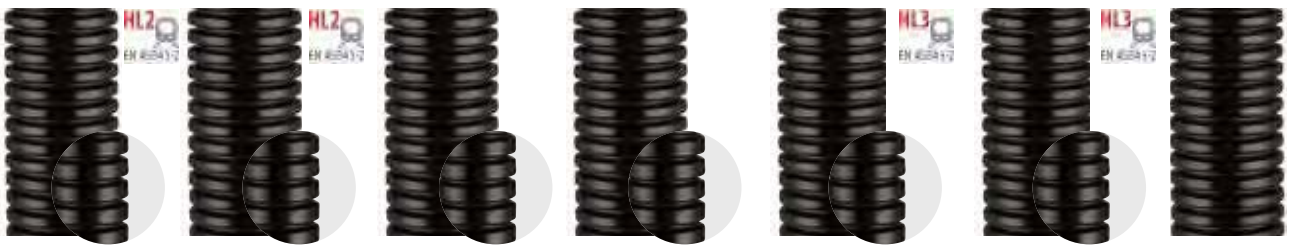

<b>PA 12</b> für sehr flexible Anwendungen im Außenbereich for very flexible applications, outdoor 02.10	<b>PA 12-D</b> dickwandig, für schwere Anwendungen im Außenbereich thick walled, for heavy applications, outdoor 02.11	<b>PA 12-S</b> für sehr flexible Anwendungen im Außenbereich for very flexible applications, outdoor 02.12	<b>PA 12-SD</b> dickwandig, für schwere Anwendungen im Außenbereich thick walled, for heavy applications, outdoor 02.13	<b>PA 12-F</b> erhöhter Brandschutz speziell für Schienenfahrzeuge best fire protection, esp. for the railway industry 02.14	<b>PA 12-FD</b> dickwandig, erhöhter Brandschutz, speziell für Schienenfahrzeuge thick walled, best fire protection (railways) 02.15	<b>PA 12-ESD</b> antistatisch, ableitfähig EX Bereich antistatic, conductive, ex area 02.16
-------------------------------------------------------------------------------------------------------------------	---------------------------------------------------------------------------------------------------------------------------------	---------------------------------------------------------------------------------------------------------------------	----------------------------------------------------------------------------------------------------------------------------------	---------------------------------------------------------------------------------------------------------------------------------------	-----------------------------------------------------------------------------------------------------------------------------------------------	------------------------------------------------------------------------------------------------------



10 – 54,5	10 – 54,5	10 – 54,5	10 – 54,5	10 – 54,5	13 – 54,5	21,2 – 42,5
Polyamid 12 Polyamide 12	Polyamid 12 Polyamide 12	Polyamid 12 Polyamide 12	Polyamid 12 Polyamide 12	Polyamid 12 Polyamide 12	Polyamid 12 Polyamide 12	Polyamid 12 mod. Polyamide 12 mod.
-50° C ... +100° C	-50° C ... +100° C	-50° C ... +100° C	-50° C ... +100° C	-50° C ... +100° C	-50° C ... +100° C	-50° C ... +100° C
IP 68   69K	IP 68   69K	IP 68   69K	IP 68   69K	IP 68   69K	IP 68   69K	IP 68   69K
V2 [UL 94]	V2 [UL 94]	V2 [UL 94]	V2 [UL 94]	V2 [UL 94]	V2 [UL 94]	HB [UL 94]

✓	✓	✓	✓	-	-	✓
✓	✓	-	-	✓	✓	✓
✓	✓	✓	✓	✓	-	✓
✓	✓	✓	✓	-	-	-
✓	✓	✓	✓	-	-	-
✓	✓	✓	✓	✓	-	✓
-	-	-	-	-	-	✓



## ROHRflex® WELLSCHLÄUCHE MIT FLEXAquick® ANSCHLUSSTECHNIK ROHRflex® TUBINGS WITH FLEXAquick® CONNECTORS



**PP**  
wenig flexibel,  
für wirtschaftliche  
Anwendungen  
non-flexible, for  
economic applications  
Seite | page 02.17



**PU**  
für sehr flexible  
Anwendungen  
öl- | benzinbeständig  
for very flexible applications  
oil | fuel resistant  
02.18



**PA 6-UL-SD**  
wirtschaftlich,  
UL-geprüft  
economical,  
UL approved  
02.7



**PA 6-LG**  
geschlitzt, wirtschaftlich,  
für nachträgliche  
Installationen | Reparaturen  
slitted, economical,  
for retrofit and repair  
02.5



**PA 6-CU**  
CU-Geflecht, für  
EMV Anwendungen  
CU braiding, for  
EMC applications  
02.9

Zulassungen Recognition					
Abmessung AD Size range OD	10 – 54,5	13 – 54,5	21,2 – 54,5	10 – 54,5	13 – 54,5
Material Material	Polypropylen PP Polypropylene PP	Polyurethan Polyurethane	Polyamid Polyamide	Polyamid 6 Polyamide 6	Polyamid 6 Polyamide 6
Temperaturbereich Temperature range	-40° C ... +120° C	-40° C ... +120° C	-25° C ... +120°	-25° C ... +120°	-40° C ... +120° C
Schutzart Protection class	IP 68   69K	IP 68   69K	IP 68   69K	IP 40	IP 68   69K
Brandklasse Flammability class	HB [UL 94]	HB [UL 94]	V2 [UL 94]	HB [UL 94]	HB [UL 94]
<b>Anwendungsgebiete Applications</b>					
Maschinen-   Anlagenbau Machine   Plant Construction	✓	✓	✓	✓	✓
Schienenfahrzeuge Railway Industry	-	-	-	-	-
Fahrzeugbau Automotive	✓	✓	-	✓	✓
Schiffsbau Shipbuilding	✓	✓	-	✓	✓
Automation	✓	✓	✓	✓	✓
Elektroanlagen Electrical Installations	✓	✓	✓	✓	✓
nachträgliche Installation for retrofit and repair	-	-	-	✓	-
EMV Anwendungen emc applications	-	-	-	-	✓



Passende Anschluss-technik siehe  
FLEXAquick Verschraubungen  
Seiten 6-7

Suitable connectors please see  
FLEXAquick connectors  
pages 6-7



RGE-M  
03.26



**MULTI PA 6**

Kabelsammler für große Kabelmengen  
cable buncher for large quantity of cables

02.19



**MULTI PA 12**

Kabelsammler für große Kabelmengen  
cable buncher for large quantity of cables

02.19



**DUO PA 6**

zweiteilig, längs teilbar und wiederverschließbar  
two-pieces, dividable and recloseable, for retrofit and repair

02.20



**DUO PP**

zweiteilig, längs teilbar und wiederverschließbar  
two-pieces, dividable and recloseable, for retrofit and repair

02.21



**FLEXAzip**

geschlitzt, mit Verschlussprofil für nachträgliche Installationen  
slitted, with closing profile for additional applications

02.22



56 – 95

56 – 95

10 – 79,0

10 – 79,0

13,0 – 54,5

Polyamid 6  
Polyamide 6

Polyamid 12  
Polyamide 12

Polyamid 6  
Polyamide 6

Polypropylen PP  
Polypropylene PP

Polyamid | TPE  
Polyamide | TPE

-40° C ... +120° C

-50° C ... +100° C

-40° C ... +120° C

-25° C ... +135° C

-40° C ... +100° C

IP 68 | 69K

IP 68 | 69K

IP 40

IP 40

IP 40

HB [UL 94]

HB [UL 94]

HB [UL 94]

V2 [UL 94]

HB [UL 94]



MULTI – GFP  
03.44

MULTI – WFP  
03.45



RQG – DUO – M  
03.25



GMK – DUO – M  
09.07



## METALLSCHUTZSCHLÄUCHE | MIT KLEINSTEN ABMESSUNGEN FÜR DIE SENSOR TECHNIK PROTECTIVE METAL CONDUITS | WITH SMALLEST DIMENSIONS FOR SENSOR TECHNOLOGY



<b>SPR</b>	<b>SPR-VA</b>	<b>SPR-PVC</b> <b>SPR-VA-PVC</b>	<b>SPR-PVC-ESD</b>	<b>SPR-VA-PU</b>	<b>FLEXAgraff®-VA</b>	<b>FDW-VA</b>
S-Profil S profile	S-Profil S profile	S-Profil PVC-Mantel S profile PVC sheathing	S-Profil PVC-Mantel S profile, PVC sheathing	S-Profil PU-Mantel S profile PU sheathing	Agraff Profil double overlapped profile	Spezialwendel Edelstahl gewickelt Special protective conduit helix
Seite   page	4.2	4.3	7.8	7.9	7.10	4.7

### Zulassungen Recognition

Abmessung AD Size range OD	4,9 – 13,0	2,3 – 56	6,0 – 14,0	7,0 – 11,0	3,6	6,0 – 45,0	3,1 – 9,6
Material Material	Stahl verzinkt galvanized steel	Edelstahl stainless steel	Stahl verzinkt PVC Edelstahl PVC galv. steel PVC stainless steel PVC	Stahl verzinkt PVC galvanized steel PVC	Edelstahl PU stainless steel PU	Edelstahl V2A stainless steel 304 [AISI]	Edelstahl V2A stainless steel 304 [AISI]
Temperaturbereich Temperature range	-50°C ... +250°C	-200°C ... +600°C	-25°C ... +90°C	-25°C ... +80°C	-40°C ... +80°C	-200°C ... +600°C	-200°C ... +600°C
Schutzart Protection class	IP 40	IP 40	IP 68	IP 68	IP 68	IP 40	

### Anwendungsgebiete Applications

Maschinen-   Anlagenbau Machine   Plant Construction	✓	✓	✓	✓	-	✓	✓
Schienenfahrzeuge Railway Industry	✓	✓	-	-	-	✓	-
Fahrzeugbau Automotive	✓	✓	-	✓	-	✓	-
Schiffsbau Shipbuilding	✓	✓	-	✓	-	✓	-
Automation Automation	✓	✓	✓	✓	-	✓	✓
Elektroanlagen Electrical Installations	✓	✓	✓	✓	-	✓	✓
Optoelektronik   Sensortechnik Opto-electronics   Sensor Techn.	✓	✓	✓	✓	✓	✓	✓
Ex-Bereich Ex Area	✓	✓	-	✓	-	✓	-



### ANSCHLUSSTECHNIK | CONNECTORS



US-MIP  
8.2



US2-M  
8.8



USDR-M  
8.10



USZ-M  
8.12



USZ-EX-M  
8.14



LI-MIP  
8.18



LIF-MIP  
8.19



USB-M  
8.20



USW-MIP  
8.22

**METALLSCHUTZSCHLÄUCHE**  
PROTECTIVE METAL CONDUITS

**METALLSCHUTZSCHLÄUCHE MIT GEFLECHT**  
PROTECTIVE METAL CONDUITS WITH BRAIDING



**SPR-AS**

**FLEXAgraff®-AS**

**SPR-CU-AS**

**SPR-EDU-AS**

**FLEXAgraff®-CU-AS**

S-Profil  
S profile

Agraff Profil  
double overlapped profile

S-Profil, verzinnte  
Kupferdrahtumflechtung  
S profile  
tinned copper wire braiding

S-Profil  
Stahldrahtumflechtung  
S profile, galvanized  
steel wire braiding

Agraff Profil  
Verzinnte Kupferdrahtumflechtung  
double overlapped profile  
tinned copper wire braiding

4.2

4.6

4.5

4.4

4.8



10 – 56

10 – 56

10 – 56

10 – 56

14 – 56

Stahl verzinkt  
galvanized steel

Stahl verzinkt  
galvanized steel

Stahl verzinkt | Kupfer verzinkt  
galvanized steel | tinned copper

Stahl verzinkt  
galvanized steel

Stahl verzinkt | Kupfer verzinkt  
galvanized steel | tinned copper

-50° C ... +250° C

-50° C ... +250° C

-50° C ... +250° C

-50° C ... +250° C

-50° C ... +250° C

IP 40

IP 40

IP 40

IP 40

IP 40



ZUBEHÖR | ACCESSORIES



MSD  
8.33



TED  
8.33



EK  
8.34



EEM  
8.35



## METALLSCHUTZSCHLÄUCHE | FLÜSSIGKEITSDICHT PROTECTIVE METAL CONDUITS | LIQUID TIGHT



**SPR-PVC-AS**  
**SPR-PVC**  
S Profil  
PVC-Mantel  
S profile  
PVC sheathing

**SPR-PA**  
S Profil  
PA-Mantel  
S profile  
PA sheathing

**SPR-PU-AS**  
S Profil  
ölbeständiger  
PU-Mantel  
S profile  
oil-resistant  
PU sheathing

**SPR-PU-F**  
S Profil  
flammwidriger  
PU-Mantel  
S profile  
flame retardant  
PU sheathing

**SPR-PVC-EDU-AS**  
S Profil  
PVC-Mantel  
Stahldrahtumflechtung  
S profile, PVC sheathing  
galvanized steel wire  
braiding

**FLEXAgraff®-PU-AS**  
Agraff-Profil  
ölbeständiger  
PU-Mantel  
Agraff profile  
oil-resistant  
PU sheathing

Seite | page 05.2/3

05.4

05.5

05.6

05.7

05.8

### Zulassungen Recognition



### Abmessung AD Size range OD

10 – 56 | 7 - 12

10 – 56

10 – 56

10 – 56

14 – 56

10 – 56

### Material Material

Stahl verzinkt | PVC  
galv. steel | PVC

Stahl verzinkt | PA  
galv. steel | PA

Stahl verzinkt | PU  
galv. steel | PU

Stahl verzinkt | PU  
galv. steel | PU

Stahl verzinkt | PVC  
galv. steel | PVC

Stahl verzinkt | PU  
galv. steel | PU

### Temperaturbereich Temperature range

-25°C ... +90°C

-50°C ... +120°C

-50°C ... +100°C

-50°C ... +100°C

-25°C ... +90°C

-50°C ... +100°C

### Schutzart Protection class

IP 68

IP 68

IP 68

IP 68

IP 68

IP 68

### Brandklasse Flammability class

V2 [UL 94]

V0 [UL 94]

V2 [UL 94]

### Anwendungsgebiete Applications

#### Maschinen- | Anlagenbau Machine | Plant Construction



#### Schienerfahrzeuge Railway Industry



#### Fahrzeugbau Automotive



#### Schiffsbau Shipbuilding



#### Automation Automation



#### Elektroanlagen Electrical Installations



#### Lebensmittelindustrie Food and Beverage Industry



### ANSCHLUSSTECHNIK | CONNECTORS



US-M|P  
08.2



US2-M  
08.8



USDR-M  
08.10



USZ-M  
08.12



US-FOOD-M  
08.28



EG-M|P  
08.29



LI-M|P  
08.18



LIF-M|P  
08.19



USD-M|P  
08.16



USB-M  
08.20



USW-M|P  
08.22



EW 45-M|P  
08.30



EW 90-M|P  
08.31

**METALLSCHUTZSCHLÄUCHE | FLÜSSIGKEITSDICHT**  
**PROTECTIVE METAL CONDUITS | LIQUID TIGHT**



**FLEXAgraff®-PU-F**

Agraff Profil  
 flammwidriger PU-Mantel  
 Agraff profile  
 flame retardant PU sheathing

05.9

**FLEXAgraff®-SI-ASF**

Agraff Profil  
 SI-Mantel  
 Agraff profile  
 SI sheathing

05.10

**FLEXAgraff®-CU-PU**

Agraff Profil, verzinn  
 Kupferdrahtumflechtung  
 PU-Mantel  
 Agraff profile, tinned  
 copper wire braiding  
 PU sheathing

05.11

**LIQUID-Tight-FOOD**

Glatter PU-Mantel  
 extra flüssigkeitsdicht  
 lebensmittelecht  
 smooth PU sheathing  
 extra liquid tight  
 food-safe

05.15

**LIQUID-Tight-EF**

Glatter PVC-Mantel  
 extra flüssigkeitsdicht  
 smooth PVC sheathing  
 extra liquid tight

05.12

**LIQUID-Tight-UL-CSA**

Kupfer-Erdleiter  
 glatter PVC-Mantel  
 copper ground lead  
 glatter PVC-Mantel  
 smooth PVC sheathing

05.14



10 - 56

14 - 56

14 - 56

1/2" - 1 1/4"

5/16" - 2"

3/8" - 2"

Stahl verzinkt | PU  
 galvanized steel | PU

Stahl verzinkt | SI  
 galvanized steel | SI

Stahl verzinkt | CU | PU  
 galvanized steel | PU

Stahl verzinkt | PU  
 galvanized steel | PU

Stahl verzinkt | PVC  
 galvanized steel | PVC

Stahl verzinkt | PVC  
 galvanized steel | PVC

-50° C ... +100° C

-50° C ... +180° C

-50° C ... +100° C

-40° C ... +80° C

-25° C ... +90° C

-25° C ... +70° C

IP 68

IP 68

IP 68

IP 68 | IP 69K

IP 68

IP 68

V0 [UL 94]

V2 [UL 94]

✓	✓	✓	✓	✓	✓
✓	-	✓	-	-	-
✓	✓	✓	-	✓	✓
✓	✓	✓	-	✓	✓
✓	✓	✓	✓	✓	✓
✓	✓	✓	✓	✓	✓
-	-	-	✓	-	-

ZUBEHÖR | ACCESSORIES



MSD  
08.33



TED  
08.33



EK  
08.34



EEM  
08.35



## KUNSTSTOFFSCHUTZSCHLÄUCHE PROTECTIVE PLASTIC CONDUITS



**AIRflex®-  
KUW-PVC-AS**  
Federstahldraht-  
wendel, PVC Mantel  
helix of spring steel  
wire, PVC sheathing

Seite | page

06.2



**AIRflex®-  
KUW-PU-AS**  
Federstahldraht-  
wendel, PU Mantel  
helix of spring steel  
wire, PU sheathing

06.3



**AIRflex®-  
KUW-EDU**  
PVC-Mantel  
Stahldrahtumflechtung  
PVC sheathing  
galvanized steel wire  
braiding

06.4



**AIRflex®-K**  
Hartkunststoffwendel  
innen glatt  
helix of rigid plastic  
plain inside surface

06.5



**AIRflex®-GRS**  
Hartkunststoffwendel  
innen|außen glatt  
helix of rigid plastic  
plain inside|outside

06.6



**AIRflex®-GRS-  
FOOD**  
Hartkunststoffwendel  
PVC, lebensmittelecht  
innen|außen glatt  
helix of rigid plastic  
PVC, food-safe

06.7

### Zulassungen Recognition



### Abmessung AD Size range OD

10 – 56

10 – 56

14 – 56

10 – 56

14 – 56

1/2" – 1 1/4"

### Material Material

Stahldraht | PVC  
steel wire

Stahldraht | PU  
steel wire

Stahldraht | PVC | Stahl  
steel wire | PVC | galv. steel

Hartkunststoff | PVC  
rigid plastic

Hartkunststoff | PVC  
rigid plastic

Hartkunststoff | PVC  
rigid plastic

### Temperaturbereich Temperature range

-25° C ... +90° C

-40° C ... +100° C

-25° C ... +90° C

-25° C ... +70° C

-25° C ... +70° C

-25° C ... +50° C

### Schutzart Protection class

IP 68

IP 68

IP 68

IP 68

IP 68

IP 68 | IP 69K

### Brandklasse Flammability class

V2 [UL 94]

### Anwendungsgebiete Applications

#### Maschinen- | Anlagenbau Machine | Plant Construction



#### Schienenfahrzeuge Railway Industry

-

-

-

-

-

-

#### Fahrzeugbau Automotive



-

#### Automation Automation



#### Elektroanlagen Electrical Installations



#### Als Saugschlauch As suction hose



-



-

#### Lichtwellenleiter Technik Beam wave guide Technology

-

-

-

-

-

-

#### Medizintechnik Medical Technology

-

-

-

-

-

-

#### Lebensmittelindustrie Food and Beverage Industry

-

-

-

-

-



### ANSCHLUSSTECHNIK CONNECTORS



USK – M|P  
08.26



LKI – M|P  
08.27



US2 – M  
08.8



USDR – M  
08.10



US – FOOD – M  
08.28



US – M|P  
08.2



USZ – M  
08.12



NIMS – M|P  
08.32



USW – M|P  
08.22





GEFLECHTSCHLÄUCHE  
BRAIDINGS



<b>HG-PA</b> Hohlgeflecht-Schlauch wire braiding round braiding 07.2	<b>HG-PET022</b> Hohlgeflecht-Schlauch Rundgeflecht wire braiding round braiding 07.3	<b>HG-CU   CU-F HG-CU-K</b> Hohlgeflecht-Schlauch Rundgeflecht wire braiding round braiding 07.4/5	<b>HG-EDU</b> Hohlgeflecht-Schlauch Rundgeflecht wire braiding round braiding 07.6
----------------------------------------------------------------------------------	------------------------------------------------------------------------------------------------------	-----------------------------------------------------------------------------------------------------------------------	---------------------------------------------------------------------------------------------------

SPEZIALSCHUTZSCHLÄUCHE  
SPECIAL PROTECTIVE CONDUITS



<b>PS-VA PSL-VA</b> Glasseiden- umflechtung SI-Mantel fiber glass braiding SI sheathing 07.11	<b>FLEXAspiral PE FLEXAspiral PA 12</b> Wickel- und Bündelungsspirale spiral bindings 07.12	<b>FLEXAhightemp</b> Calciumsilikat-Geflecht SI-Mantel, Feuerschutz calcium-silicate braiding SI sheathing, fire protection 07.14
---------------------------------------------------------------------------------------------------------------------	-------------------------------------------------------------------------------------------------------------	-----------------------------------------------------------------------------------------------------------------------------------------------------

DB	DB SNCF EN 45545-2	DVE LME				
NW   ID 5 – 50	NW   ID 4 – 50	NW   ID 6 – 35	NW   ID 6 – 35	NW   ID 2,5 – 8,0 NW   ID 3,3 – 7,7	NW   ID 6 – 12	NW   ID 10 – 60
Polyamid-Monofile polyamide monofilés	PET-Monofile PET monofilés	verzinnete Kupferdrähte tinned copper wires	verzinkte Stahldrähte galvanized steel wires	Edelstahl   SI stainless steel V2A   SI	LD-PE PA 12	Calciumsilikat   SI calcium-silicate   SI
-50° C ... +120° C	-50° C ... +150° C	-50° C ... +250° C	-50° C ... +250° C	-50° C ... +180° C	-40° C ... + 90° C -40° C ... +100° C	-50° C ... +350° C
				IP 68		IP 68
V2 [UL 94]						
✓	✓	✓	✓	-	✓	✓
✓	✓	✓	-	-	-	-
✓	✓	✓	✓	-	✓	✓
✓	✓	✓	✓	-	✓	✓
✓	✓	✓	✓	-	✓	✓
-	-	-	-	✓	-	-
-	-	-	-	✓	-	-
-	-	-	-	-	-	-

ZUBEHÖR | ACCESSORIES



MSD  
08.33



TED  
08.33



EK  
08.34



SGL  
08.32



EEM  
08.35



AK  
08.34



## SCHUTZSCHLAUCH AUSWAHLKRITERIEN SELECTION CRITERIA FOR PROTECTIVE CONDUITS

REACH RoHS																			
SCHUTZSCHLAUCH PROTECTIVE CONDUIT	Material Material	IP-Schutzgrad IP-rate	Temperatur min. [°C] Temperature min. [°C]	Temperatur max. [°C] Temperature max. [°C]	Temperatur kurzzeitig [°C] Temperature short term [°C]	Halogenfrei Free of halogen	UV - beständig [schwarz] UV - resistance [black]	Mit Isolationsseigenschaften With insulating characteristics	Nicht - Flammausbreitend No - flame propagation	Brennbarkeit [UL94] Flammbarkeit [UL94]	Flammbeständigkeit Flame resistance	Druckfestigkeit Resistance to compression	Schlagfestigkeit Resistance to impact	Flexibilität Flexibility	Zugfestigkeit Tensile strength	Biegewechselfestigkeit Alternative bending strength	Ölbeständigkeit Oil resistance	Benzinbeständigkeit Petrol resistance	Rauchgasdichte Density of smoke
ROHRflex PA 6	PA6	IP68	-40°	+120°	+150°	✓	✓	✓	✓	V0									
ROHRflex PA 6 - D	PA6	IP68	-40°	+120°	+150°	✓	✓	✓	✓	V0									
ROHRflex PA 6 - S	PA6	IP68	-40°	+120°	+150°	✓	✓	✓	✓	V2									
ROHRflex PA 6 - L   PA 6 - LL	PA6	IP68	-25°	+120°	-	✓	✓	✓	✓	HB									
ROHRflex PA 6 - UL - SD	PA6	IP68	-25°	+120°	-	✓	✓	✓	✓	V2									
ROHRflex PA 6 - HT	PA6	IP68	-25°	+150°	+170°	✓	✓	✓	✓	V2									
ROHRflex PA 12	PA12	IP68	-50°	+100°	+130°	✓	✓	✓	✓	V2									
ROHRflex PA 12 - D	PA12	IP68	-50°	+100°	+130°	✓	✓	✓	✓	V2									
ROHRflex PA 12 - S	PA12	IP68	-50°	+100°	+130°	✓	✓	✓	✓	V2									
ROHRflex PA 12 - SD	PA12	IP68	-50°	+100°	+130°	✓	✓	✓	✓	V2									
ROHRflex PA 12 - F	PA12	IP68	-50°	+100°	+130°	✓	✓	✓	✓	V2									
ROHRflex PA 12 - FD	PA12	IP68	-50°	+100°	+130°	✓	✓	✓	✓	V2									
ROHRflex PA 12 - ESD	PA12	IP68	-50°	+100°	+130°	✓	✓	✓	✓	HB									
ROHRflex PU	PU	IP68	-40°	+120°	+150°	✓	✓	✓	✓	HB									
ROHRflex PP	PP	IP68	-40°	+120°	+150°	✓	✓	✓	✓	HB									
ROHRflex PA 6 - CU	PA6 CU	IP68	-40°	+120°	+150°	✓	✓	✓	✓	HB									
ROHRflex Duo PA 6	PA6	IP40	-40°	+120°	+150°	✓	✓	✓	✓	HB									
ROHRflex Duo PP	PP	IP40	-25°	+135°	+150°	-	✓	✓	✓	V2									
ROHRflex MULTI PA 6	PA6	IP68	-40°	+120°	+150°	✓	✓	✓	✓	HB									
ROHRflex MULTI PA 12	PA12	IP68	-50°	+100°	+130°	✓	✓	✓	✓	HB									
SPR   SPR - AS	Stn	IP40	-50°	+250°	-	✓	✓	-	✓	-									
SPR - VA	V2A	IP40	-200°	+600°	-	✓	✓	-	✓	-									
SPR - EDU - AS	Stn Stn	IP40	-50°	+250°	-	✓	✓	-	✓	-									
SPR - CU - AS	Stn CU	IP40	-50°	+250°	-	✓	✓	-	✓	-									
FLEXAgraff - AS	Stn	IP40	-50°	+250°	-	✓	✓	-	✓	-									
FLEXAgraff - VA	V2A	IP40	-200°	+600°	-	✓	✓	-	✓	-									
FLEXAgraff - CU - AS	Stn CU	IP40	-50°	+250°	-	✓	✓	-	✓	-									
SPR - PVC   SPR - PVC - AS	Stn PVC	IP68	-25°	+90°	+100°	-	-	✓	✓	-									
SPR - VA - PVC	V2A PVC	IP68	-25°	+90°	+100°	-	-	✓	✓	-									
SPR - VA - PU	V2A PU	IP68	-25°	+90°	+100°	✓	✓	✓	✓	-									
SPR - PVC - ESD	Stn PVC	IP68	-25°	+80°	+100°	-	✓	-	✓	-									
SPR - PA	Stn PA	IP68	-50°	+120°	+150°	✓	✓	✓	✓	-									
SPR - PU - AS	Stn PU	IP68	-50°	+100°	+130°	✓	✓	✓	✓	V2									
SPR - PU - F	Stn PU	IP68	-50°	+100°	+130°	✓	✓	✓	✓	V0									
SPR - PVC - EDU - AS	Stn PVC	IP68	-25°	+90°	+100°	-	-	✓	✓	-									
FLEXAgraff - PU - AS	Stn PU	IP68	-50°	+100°	+130°	✓	✓	✓	✓	V2									
FLEXAgraff - PU - F	Stn PU	IP68	-50°	+100°	+130°	✓	✓	✓	✓	V0									
FLEXAgraff - SI - ASF	Stn Si	IP68	-50°	+180°	-	✓	✓	✓	✓	-									
FLEXAgraff - CU - PU	Stn CU PU	IP68	-50°	+100°	+130°	✓	✓	✓	✓	V2									
LIQUID - TIGHT - EF	Stn PVC	IP68	-25°	+90°	+100°	-	-	✓	✓	-									
LIQUID - TIGHT - EF - OR	Stn PVC	IP68	-25°	+90°	+100°	-	-	✓	✓	-									
LIQUID - TIGHT - UL - CSA	Stn PVC	IP68	-25°	+70°	+100°	-	-	✓	✓	-									
LIQUID - TIGHT - FOOD	Stn PU	IP68	-40°	+80°	+110°	✓	-	✓	-	-									
AIRflex - KUW - PVC - AS	F PVC	IP68	-25°	+90°	+100°	-	-	✓	-	-									
AIRflex - KUW - PU - AS	F PU	IP68	-40°	+100°	+120°	✓	✓	✓	✓	V2									
AIRflex - KUW - EDU	F PVC Stn	IP68	-25°	+90°	+100°	-	-	✓	-	-									
AIRflex - K	PVC	IP68	-25°	+70°	+100°	✓	-	✓	-	-									
AIRflex - GRS	PVC	IP68	-25°	+70°	+100°	✓	-	✓	-	-									
AIRflex - GRS - FOOD	PVC	IP68	-25°	+50°	+70°	✓	-	✓	-	-									
FLEXAhightemp	Si	IP68	-50°	+350°	+700°	✓	✓	✓	✓	-									
HG - PA	PA6	IP40	-50°	+120°	+150°	✓	✓	✓	✓	V2									
HG - PET022	PET	IP40	-50°	+150°	+175°	✓	✓	✓	✓	-									
HG - CU   - CU - F   HG - CU - K	PVC CU	IP40	-50°	+250°	-	✓	-	✓	✓	-									
HG - EDU	Stn	IP40	-50°	+250°	-	✓	-	-	✓	-									
PS - VA   PSL - VA	V2A Si GL	IP68	-50°	+180°	-	✓	✓	✓	✓	-									
FDW - VA	V2A		-200°	+600°	-	-	-	-	-	-									

SCHUTZSCHLAUCH AUSWAHLKRITERIEN  
SELECTION CRITERIA FOR PROTECTIVE CONDUITS

SCHUTZSCHLAUCH PROTECTIVE CONDUIT	Schienenfahrzeuge Railway Industry					Schiff Ship		Industrie Industry		EINSATZGEBIETE APPLICATIONS													
	EN 45545 Teil2 EN 45545 part2	DIN 5510 DIN 5510	NFF 16-101/102 NFF 16-101/102	UNI CEI 11170 UNI CEI 11170	ASTM E162/E662 ASTM E162/E662	Lloyd's Register Lloyd's Register	DNV DNV	VDE Zulassung [EN 61386] VDE approval [EN 61386]	UL   CSA Zulassung [UL 1696] UL   CSA approval [UL 1696]	Rütteltest [EN IEC 61373] Vibration test [EN IEC 61373]	EMV Zulassung [EN 50289 1-6] EMC approval [EN 50289 1-6]	Maschinen- und Anlagenbau Machine   Plant constructions	Fahrzeugbau Automotive	Schienefahrzeuge Railway industry	Schiffsbau Shipbuilding	Automation Automation	Elektroanlagen Electrical installations	Medizintechnik Medical technology	Lebensmittelindustrie Food and beverage industry	Sensortechnik Sensor technology	Ex-Bereich [EN 1127-1] Ex-area [EN 1127-1]	EMV-Anwendungen EMC-applications	Hochtemperaturbereiche High temperature areas
ROHRflex PA 6	HL3	✓	✓	✓	✓	✓	✓	✓	✓	✓	✓	✓	✓	✓	✓	✓	✓	✓	✓	✓	✓	✓	✓
ROHRflex PA 6-D	HL3	✓	-	-	-	✓	✓	✓	✓	✓	✓	✓	✓	✓	✓	✓	✓	✓	✓	✓	✓	✓	✓
ROHRflex PA 6-S	-	✓	✓	-	✓	✓	✓	✓	✓	✓	✓	✓	✓	✓	✓	✓	✓	✓	✓	✓	✓	✓	✓
ROHRflex PA 6-L   PA 6-LL	-	-	-	-	-	✓	✓	✓	✓	✓	✓	✓	✓	✓	✓	✓	✓	✓	✓	✓	✓	✓	✓
ROHRflex PA 6-UL-SD	-	-	-	-	-	-	✓	-	-	-	✓	✓	✓	✓	✓	✓	✓	✓	✓	✓	✓	✓	✓
ROHRflex PA 6-HT	-	-	-	-	-	-	-	✓	-	-	✓	✓	✓	✓	✓	✓	✓	✓	✓	✓	✓	✓	✓
ROHRflex PA 12	HL2	✓	✓	✓	✓	✓	✓	✓	✓	✓	✓	✓	✓	✓	✓	✓	✓	✓	✓	✓	✓	✓	✓
ROHRflex PA 12-D	HL2	✓	✓	✓	✓	✓	✓	✓	✓	✓	✓	✓	✓	✓	✓	✓	✓	✓	✓	✓	✓	✓	✓
ROHRflex PA 12-S	-	✓	✓	-	✓	-	-	✓	-	-	✓	✓	✓	✓	✓	✓	✓	✓	✓	✓	✓	✓	✓
ROHRflex PA 12-SD	-	-	-	-	-	-	-	✓	-	-	✓	✓	✓	✓	✓	✓	✓	✓	✓	✓	✓	✓	✓
ROHRflex PA 12-F	HL3	-	-	-	-	-	-	✓	-	-	✓	✓	✓	✓	✓	✓	✓	✓	✓	✓	✓	✓	✓
ROHRflex PA 12-FD	HL3	-	-	-	-	-	-	✓	-	-	✓	✓	✓	✓	✓	✓	✓	✓	✓	✓	✓	✓	✓
ROHRflex PA 12-ESD	-	-	-	-	-	-	-	-	-	-	✓	✓	✓	✓	✓	✓	✓	✓	✓	✓	✓	✓	✓
ROHRflex PU	-	-	-	-	-	-	-	-	-	-	✓	✓	✓	✓	✓	✓	✓	✓	✓	✓	✓	✓	✓
ROHRflex PP	-	-	-	-	-	✓	-	✓	-	-	✓	✓	✓	✓	✓	✓	✓	✓	✓	✓	✓	✓	✓
ROHRflex PA 6-CU	-	-	-	-	-	-	-	-	-	✓	✓	✓	✓	✓	✓	✓	✓	✓	✓	✓	✓	✓	✓
ROHRflex Duo PA 6	-	-	-	-	-	-	-	-	-	-	✓	✓	✓	✓	✓	✓	✓	✓	✓	✓	✓	✓	✓
ROHRflex Duo PP	-	-	-	-	-	-	-	-	-	-	✓	✓	✓	✓	✓	✓	✓	✓	✓	✓	✓	✓	✓
ROHRflex MULTI PA 6	-	-	-	-	-	-	-	✓	-	-	✓	✓	✓	✓	✓	✓	✓	✓	✓	✓	✓	✓	✓
ROHRflex MULTI PA 12	-	-	-	-	-	-	-	✓	-	-	✓	✓	✓	✓	✓	✓	✓	✓	✓	✓	✓	✓	✓
SPR   SPR-AS	-	-	-	-	-	-	-	✓	-	-	✓	✓	✓	✓	✓	✓	✓	✓	✓	✓	✓	✓	✓
SPR-VA	-	-	-	-	-	-	-	-	-	-	✓	✓	✓	✓	✓	✓	✓	✓	✓	✓	✓	✓	✓
SPR-EDU-AS	-	-	-	-	-	-	-	✓	-	-	✓	✓	✓	✓	✓	✓	✓	✓	✓	✓	✓	✓	✓
SPR-CU-AS	-	-	-	-	-	-	-	✓	-	-	✓	✓	✓	✓	✓	✓	✓	✓	✓	✓	✓	✓	✓
FLEXAgraff-AS	-	-	-	-	-	-	-	✓	-	-	✓	✓	✓	✓	✓	✓	✓	✓	✓	✓	✓	✓	✓
FLEXAgraff-VA	-	-	-	-	-	-	-	-	-	-	✓	✓	✓	✓	✓	✓	✓	✓	✓	✓	✓	✓	✓
FLEXAgraff-CU-AS	-	-	-	-	-	-	-	✓	-	✓	✓	✓	✓	✓	✓	✓	✓	✓	✓	✓	✓	✓	✓
SPR-PVC   SPR-PVC-AS	-	-	-	-	-	-	-	✓	-	-	✓	✓	✓	✓	✓	✓	✓	✓	✓	✓	✓	✓	✓
SPR-VA-PVC	-	-	-	-	-	-	-	-	-	-	✓	✓	✓	✓	✓	✓	✓	✓	✓	✓	✓	✓	✓
SPR-VA-PU	-	-	-	-	-	-	-	-	-	-	✓	✓	✓	✓	✓	✓	✓	✓	✓	✓	✓	✓	✓
SPR-PVC-ESD	-	-	-	-	-	-	-	-	-	-	✓	✓	✓	✓	✓	✓	✓	✓	✓	✓	✓	✓	✓
SPR-PA	HL2	-	-	-	-	-	-	✓	-	✓	✓	✓	✓	✓	✓	✓	✓	✓	✓	✓	✓	✓	✓
SPR-PU-AS	-	-	-	-	-	-	-	✓	-	-	✓	✓	✓	✓	✓	✓	✓	✓	✓	✓	✓	✓	✓
SPR-PU-F	HL3	✓	✓	-	-	-	-	✓	-	-	✓	✓	✓	✓	✓	✓	✓	✓	✓	✓	✓	✓	✓
SPR-PVC-EDU-AS	-	-	-	-	-	-	-	✓	-	-	✓	✓	✓	✓	✓	✓	✓	✓	✓	✓	✓	✓	✓
FLEXAgraff-PU-AS	-	-	-	-	-	-	-	✓	-	✓	✓	✓	✓	✓	✓	✓	✓	✓	✓	✓	✓	✓	✓
FLEXAgraff-PU-F	HL3	✓	✓	-	-	-	-	✓	-	-	✓	✓	✓	✓	✓	✓	✓	✓	✓	✓	✓	✓	✓
FLEXAgraff-SI-ASF	-	-	-	-	-	-	-	✓	-	-	✓	✓	✓	✓	✓	✓	✓	✓	✓	✓	✓	✓	✓
FLEXAgraff-CU-PU	-	-	-	-	-	-	-	✓	-	✓	✓	✓	✓	✓	✓	✓	✓	✓	✓	✓	✓	✓	✓
LIQUID-TIGHT-EF	-	-	-	-	-	-	-	✓	-	-	✓	✓	✓	✓	✓	✓	✓	✓	✓	✓	✓	✓	✓
LIQUID-TIGHT-EF-OR	-	-	-	-	-	-	-	-	-	-	✓	✓	✓	✓	✓	✓	✓	✓	✓	✓	✓	✓	✓
LIQUID-TIGHT-UL-CSA	-	-	-	-	-	-	-	-	-	-	✓	✓	✓	✓	✓	✓	✓	✓	✓	✓	✓	✓	✓
LIQUID-TIGHT-FOOD	-	-	-	-	-	-	-	-	✓	-	✓	✓	✓	✓	✓	✓	✓	✓	✓	✓	✓	✓	✓
AIRflex-KUW-PVC-AS	-	-	-	-	-	-	-	✓	-	-	✓	✓	✓	✓	✓	✓	✓	✓	✓	✓	✓	✓	✓
AIRflex-KUW-PU-AS	-	-	-	-	-	-	-	✓	-	-	✓	✓	✓	✓	✓	✓	✓	✓	✓	✓	✓	✓	✓
AIRflex-KUW-EDU	-	-	-	-	-	-	-	✓	-	-	✓	✓	✓	✓	✓	✓	✓	✓	✓	✓	✓	✓	✓
AIRflex-K	-	-	-	-	-	-	-	-	-	-	✓	✓	✓	✓	✓	✓	✓	✓	✓	✓	✓	✓	✓
AIRflex-GRS	-	-	-	-	-	-	-	-	-	-	✓	✓	✓	✓	✓	✓	✓	✓	✓	✓	✓	✓	✓
AIRflex-GRS-FOOD	-	-	-	-	-	-	-	-	-	-	✓	✓	✓	✓	✓	✓	✓	✓	✓	✓	✓	✓	✓
FLEXAhightemp	-	✓	-	-	-	-	-	-	-	-	✓	✓	✓	✓	✓	✓	✓	✓	✓	✓	✓	✓	✓
HG-PA	-	✓	-	-	-	-	-	-	-	-	✓	✓	✓	✓	✓	✓	✓	✓	✓	✓	✓	✓	✓
HG-PET022	HL3	✓	✓	-	-	-	-	-	-	-	✓	✓	✓	✓	✓	✓	✓	✓	✓	✓	✓	✓	✓
HG-CU   -CU-F   HG-CU-K	-	-	-	-	-	-	-	-	-	✓	✓	✓	✓	✓	✓	✓	✓	✓	✓	✓	✓	✓	✓
HG-EDU	-	-	-	-	-	-	-	-	-	-	✓	✓	✓	✓	✓	✓	✓	✓	✓	✓	✓	✓	✓
PS-VA   PSL-VA	-	-	-	-	-	-	-	-	-	-	✓	✓	✓	✓	✓	✓	✓	✓	✓	✓	✓	✓	✓
FDW-VA	-	-	-	-	-	-	-	-	-	-	✓	✓	✓	✓	✓	✓	✓	✓	✓	✓	✓	✓	✓

## KUNSTSTOFF – FÜHRUNGSKETTEN PL PL PLASTIC GUIDE CHAINS



**PL3**  
Seite | page 10.3



**PL4**  
10.4



**PL5**  
10.5

<b>Außenhöhe</b> Outer height	22	30	40
<b>Material</b> Material	PA6 GFK	PA6 GFK	PA6 GFK
<b>Temperaturbereich</b> Temperature range	-40°C ... +135°C	-40°C ... +135°C	-40°C ... +135°C
<b>Innenbreite mm</b> Inner width mm	31	38   48   68   83   113	49   61   81   111   135   177
<b>Innenhöhe mm</b> Inner height mm	18	25	34
<b>Außenbreite mm</b> Outer width mm	41	50   60   80   95   125	63   75   95   125   149   191
<b>Radien mm</b> Radii mm	35   50   70   100	50   75   100   150   200	60   100   125   150   200   250
<b>Kettenglieder/m</b> Chain links/mtr.	31 St.   pce	22 St.   pce	18 St.   pce
<b>Freitragende Länge mm max.</b> Free carrying length mm max.	1750	2300	3100
<b>Verfahrweg Standard m max.</b> Travel standard m max.	35	50	75
<b>Anwendungsgebiete</b> Applications			
<b>Automation</b> Automation	✓	✓	✓
<b>Maschinenbau</b> Machine construction	✓	✓	✓
<b>Anlagenbau</b> Plant constructions	✓	✓	✓



**Trennsteg PS**  
PS separator  
Seite | page 10.6



**Standardanschluss PB**  
PB standard connector  
10.7



**Anschluss mit Zugentlastung PBZ**  
PBZ connector with strain relief  
10.7



**Flachanschluss PB-R/L**  
PB-R/L flat connector  
10.8



**Flachanschluss PB-V**  
PB-V flat connector  
10.8

KUNSTSTOFF – FÜHRUNGSKETTEN PH  
PH PLASTIC GUIDE CHAINS



PH7

10.11

PH10

10.12

PH12

10.13

52	77	108
PA6 GFK   Aluminium	PA6 GFK   Aluminium	PA6 GFK   Aluminium
-40°C ... +135°C	-40°C ... +135°C	-40°C ... +135°C
50   65   100   150   200	75   100   150   200   250   300	100   150   200   250   300   350
34	49	80
76   91   126   176   226	109   134   184   234   284   334	142   192   242   292   342   392
75   100   150   200   300	100   150   200   300	150   200   250   300   500
14 St.   pce	10 St.   pce	8 St.   pce
3500	4600	6600
35	50	75



ANSCHLUSSTECHNIK | ZUBEHÖR  
CONNECTORS | ACCESSORIES



Trennsteg PS  
PS separator

10.14



Lagensteg LP  
LP layer stay

10.15



Standardanschluss PB  
PB standard connector

10.15



Zugentlastungsschiene SCSRN  
SCSRN strain relief bar

10.16



Schieberhalter SRP2  
SRP2 sliding fixture

10.16



Gleiter PH-G  
PH-G glider

10.16

## KABELDURCHFÜHRUNGSSYSTEME CABLE ENTRY SYSTEMS



### FFR-AL-UL-ATEX

Klemmrahmen für  
Kabeldurchführung  
mit Zugentlastung  
Material Aluminium  
Clamping frame  
for cable entry system  
with strain relief  
Material solid aluminium

Seite | page 11.2



### FFR-PA

Klemmrahmen für  
Kabeldurchführung  
mit Zugentlastung  
Material Kunststoff PA  
Clamping frame  
for cable entry system,  
with strain relief  
Material PA plastics

11.3



### FFRR-TPE-V0

Teilbare Ringraumdichtung  
Material Kunststoff PA, TPE  
Split press ring seal  
Material PA / TPE plastics

11.9



### FFKEP-PA

Kabeldurchführungsplatte  
Material Kunststoff PA /  
Elastomer  
Cable entry plate  
Material PA plastics /  
elastomer

11.10

Schutzart Protection class	IP 65	IP 64	IP 68	IP 66
Temperaturbereich Temperature range	-40°C ... +100°C	-40°C ... +100°C	-40°C ... +100°C	-30°C ... +100°C
Brandklasse Flammability class	V0 [UL 94]	HB [UL 94]	V0 [UL 94]	V0 [UL 94]
Anzahl Klemmeinsätze Number of clamping inserts	FFEK 8 max. FFEG 4 max.	FFEK 2/ 6 max. FFEG 1/ 3 max.	FFEK 8 max. FFEG 4 max.	
Kabeldurchmesser mm Cable diameter mm	2,0 – 34,5	2,0 – 34,5	2,0 – 34,5	3,0 – 20,0

### Zubehör Accessories

#### FFEK-TPE-V0 [-RAIL]

Klemmeinsätze klein  
Material TPE  
Clamping inserts small  
Material TPE



-



-

#### FFEG-TPE-V0 [-RAIL]

Klemmeinsätze groß  
Material TPE  
Clamping inserts large  
Material TPE



-



-

#### FFEK-TPE

Klemmeinsätze klein  
Material TPE  
Clamping inserts small  
Material TPE



-

-

#### FFEG-TPE

Klemmeinsätze groß  
Material TPE  
Clamping inserts large  
Material TPE



-

-

#### FFBS-PA-V0

Blindstopfen für Klemmeinsätze  
Material Kunststoff PA 6  
Blind plugs for clamping inserts  
Material PA 6 plastics



-

ALLGEMEINES ZUBEHÖR  
GENERAL ACCESSORIES

**FR – M | – P | – N | – C**

Flach-Dichtring  
Material Perbunan  
Flat-sealing  
Material perbunan **09.2**



**FRH – M | – P | – N | – C**

Flach-Dichtring  
Material Centellen  
Flat-sealing  
Material centellen **09.3**



**OR – M | – P**

O-Ring  
Material Perbunan  
O-ring  
Material perbunan **09.4**



**GM – M | – P | – N | – C**

Gegenmutter  
Material Messing vernickelt  
Counternut  
Material nickel-plated brass **09.5**



**GMK – M | – P | – N | – C**

Gegenmutter  
Material Kunststoff  
Counternut  
Material plastics **09.6**



**GMK – Duo – M**

Gegenmutter für RQG–Duo–M  
teilbar  
Material Kunststoff  
Counternut for RQG–Duo–M  
separable  
Material plastics **09.7**



**GME – M | – P**

EMV-Gegenmutter  
Material Messing vernickelt  
EMC locking nut  
Material nickel-plated brass **09.7**



**VBM – M**

Verbindungsmuffe  
Material Messing vernickelt  
Coupling sleeve  
Material nickel-plated brass **09.8**



**WIC – M | – P**

Anschlusswinkel  
Material  
Zinkdruckguss vernickelt  
Connecting elbow  
Material nickel-plated  
zinc die-casting **09.9**



**REM – M | – P**

Reduzierung für  
Verschraubungen  
Material Messing vernickelt  
Reducer for connectors  
Material nickel-plated brass **09.10**



**REK – M | – P**

Reduzierung für  
Verschraubungen  
Material Kunststoff  
Reducer for connectors  
Material plastics **09.11**



**EWM – M | – P**

Erweiterung  
für Verschraubungen  
Material Messing vernickelt  
Enlargement part for connectors  
Material nickel-plated brass **09.12**



**EWK – M | – P**

Erweiterung für  
Verschraubungen  
Material Kunststoff  
Enlargement part for  
connectors  
Material plastics **09.13**



**ADM – MP | – PM**

Adapter  
Material Messing vernickelt  
Adaptor  
Material nickel-plated brass **09.14**



**ADK – MP | – PM**

Adapter  
Material Polyamid  
Adaptor  
Material polyamide **09.15**



**ADMF – M**

Brandschott Adapter  
Material Messing vernickelt  
Fire protection closure  
Material nickel-plated brass **09.16**



**STM – M | – P**

Blindstopfen mit Kragen  
Material Messing vernickelt  
Blind plug with collar  
Material nickel-plated brass **09.17**



**STK – M | – P**

Blindstopfen  
Material Polyamid  
Blind plug  
Material polyamide **09.18**



**Z – M**

Adapter mit Zugentlastung  
Material Messing vernickelt  
Adaptor with strain relief  
Material nickel-plated brass **09.19**



**KSM – M | – P**

Kabelverschraubung  
Material Messing vernickelt  
Cable gland  
Material nickel-plated brass **09.20**



**KSK – M | – P**

Kabelverschraubung  
Material Polyamid  
Cable gland  
Material polyamide **09.21**



**DE – M | – P**

Mehrfach Dichteinsatz für  
Kabelverschraubung  
Material TPE  
Multiple sealing insert  
for cable glands  
Material TPE **09.22**



**DEO – M | – P**

Dichteinsatz ohne Bohrung  
Material TPE  
Sealing insert without bore  
hole  
Material TPE **09.22**



**BW – M | – P**

Befestigungswinkel  
Material Eloc-passiviert  
Fastening angle  
Material  
eloc-passivated **09.23**



**BWK – M | – P**

Befestigungswinkel  
Material Kunststoff  
Fastening angle  
Material plastics **09.24**



**SKM | SKM – Multi**

Schlauch-Klemmschelle  
Material Stahl verzinkt  
Tubing-clamp  
Material galvanized steel **09.25**



# 02 Kunststoff – Wellschläuche Corrugated plastic tubings



ZUORDNUNGSTABELLE  
ASSIGNMENT TABLE

Nenngröße AD Schlauch-Außen-ø	Metr. Gewinde EN 60423	PG Gewinde DIN 40430
Trade Size OD Tubing outer ø	metric thread EN 60423	PG thread DIN 40430
10,0	M 10 x 1,0	PG 7
10,0	M 12 x 1,5	
13,0	M 12 x 1,5	PG 9
13,0	M 16 x 1,5	
15,8	M 16 x 1,5	PG 11
15,8	M 20 x 1,5	
18,5	M 20 x 1,5	PG 13,5
21,2	M 20 x 1,5	PG 16
21,2	M 25 x 1,5	
28,5	M 25 x 1,5	PG 21
28,5	M 32 x 1,5	
34,5	M 32 x 1,5	PG 29
34,5	M 40 x 1,5	
42,5	M 40 x 1,5	PG 36
42,5	M 50 x 1,5	
54,5	M 50 x 1,5	PG 48
54,5	M 63 x 1,5	



Schienenfahrzeugindustrie  
Railway Technology



EMV-Anwendungen  
EMC Applications



EX-Anwendungen  
EX Applications



VIDEO



**ROHRflex® PA 6 | ROHRflex® PA 6-D**

Vollkunststoff-Wellschlauch PA 6  
Standard, für nahezu alle Anwendungen oder  
dickwandig, für schwere Anwendungen  
Corrugated all-plastic tubing PA 6  
standard, for almost all applications or  
thick-walled, for heavy applications  
V0 [UL 94] **02.2|3**



**ROHRflex® PA 6-S**

Vollkunststoff-Wellschlauch PA 6  
geringerer Brandschutz, für einfache Anwendungen  
Corrugated all-plastic tubing PA 6  
reduced fire protection, for simple applications  
V2 [UL 94] **02.4**



**ROHRflex® PA 6-L [-LG] | ROHRflex® PA 6-LL**

Vollkunststoff-Wellschlauch PA modifiziert  
geringerer Brandschutz, wirtschaftlich  
Corrugated all-plastic tubing PA modified  
reduced fire protection, economical  
HB [UL 94] **02.5|6**



**ROHRflex® PA 6-UL-SD**

Vollkunststoff-Wellschlauch PA modifiziert  
wirtschaftlich, UL geprüft  
Corrugated all-plastic tubing PA modified  
economical, UL approved  
V2 [UL 94] **02.7**



**ROHRflex® PA 6-HT**

Vollkunststoff-Wellschlauch PA 6  
für hohe Temperaturen  
Corrugated all-plastic tubing PA 6  
for high temperatures  
V2 [UL 94] **02.8**



**ROHRflex® PA 6-CU**

Vollkunststoff-Wellschlauch PA 6  
CU-Schirmgeflecht, für EMV-Anwendungen  
Corrugated all-plastic tubing PA 6  
CU wire braiding, for emc applications  
HB [UL 94] **02.9**



**ROHRflex® PA 12 | ROHRflex® PA 12-D**

Vollkunststoff-Wellschlauch PA 12  
für sehr flexible Anwendungen, oder dickwandig  
für schwere Anwendungen, Außenbereich  
Corrugated all-plastic tubing PA 12  
for very flexible applications, or thick-walled  
for heavy applications, outdoor area  
V2 [UL 94] **02.10|11**



**ROHRflex® PA 12-S | ROHRflex® PA 12-SD**

Vollkunststoff-Wellschlauch PA 12  
für sehr flexible Anwendungen, oder dickwandig  
für schwere Anwendungen, Außenbereich  
Corrugated all-plastic tubing PA 12  
for very flexible applications, or thick-walled  
for heavy applications, outdoor area  
V2 [UL 94] **02.12|13**



**ROHRflex® PA 12-F | ROHRflex® PA 12-FD**

Vollkunststoff-Wellschlauch PA 12  
erhöhter Brandschutz, oder dickwandig  
für schwere Anwendungen,  
spez. für Schienenfahrzeuge  
Corrugated all-plastic tubing PA 12  
best fire protection, or thick-walled for heavy  
applications, esp. for the railway industry  
V2 [UL 94] **02.14|15**



**ROHRflex® PA 12-ESD**

Vollkunststoff-Wellschlauch PA 12  
antistatisch, für Anwendungen im EX Bereich  
Corrugated all-plastic tubing PA 12  
antistatic for heavy applications in EX area  
HB [UL 94] **02.16**



**ROHRflex® PP**

Vollkunststoff-Wellschlauch PP  
nicht flexibel, für wirtschaftliche Anwendungen  
Corrugated all-plastic tubing PP  
non-flexible, for economic applications  
HB [UL 94] **02.17**



**ROHRflex® PU**

Vollkunststoff-Wellschlauch PU  
für sehr flexible Anwendungen, öl- | benzinbeständig  
Corrugated all-plastic tubing PU  
for very flexible applications, oil | fuel resistant  
HB [UL 94] **02.18**



**ROHRflex® MULTI**

Kabelsammler für große Kabelmengen  
Vollkunststoff-Wellschlauch PA 6 oder PA 12  
Cable buncher, for large quantity of cables  
Corrugated all-plastic tubing PA 6 or PA 12  
HB [UL 94] **02.19**



**ROHRflex®- Duo PA 6 | ROHRflex®- Duo PP**

Vollkunststoff-Wellschläuche, zweiteilig,  
der Länge nach teilbar, wiederverschließbar  
Corrugated all-plastic tubings, two-piece,  
longitudinal dividable, recloseable  
PA 6: HB [UL 94] | PP: V2 [UL 94] **02.20|21**



**FLEXAzip**

ROHRflex PA geschlitzt  
für nachträgliche Installationen  
ROHRflex PA slitted  
for additional installations  
HB [UL 94] **02.22**



**WERKZEUGE | TOOLS**

**ROHRflex® Cutter | ROHRflex® Slitter**  
zum Trennen und Schlitzten  
der ROHRflex®-Schläuche  
for cutting and slitting  
of the ROHRflex® tubings **02.23**





VO [UL 94]  
 IP 68 | IP 69K  
 -40°C ... +120°C ^ +150°C

EN / IEC 61386-23

UL 1696 | CSA 22.2  
 UR file E86359

EN 45545-2 [HL 3]

ASTM E162|E662  
 SMP 800-C

UNI CEI 11170

/GGVSEB



VIDEO

# ROHRflex® PA 6

Vollkunststoff-Wellschlauch  
 innen und außen gewellt

Corrugated all-plastic tubing  
 internally and externally corrugated

## MATERIAL

Kunststoff [PA 6]

## MATERIAL

plastics [PA 6]

## EIGENSCHAFTEN

- luft- und flüssigkeitsdicht
- ölbeständig bis +80°C
- benzinbeständig
- weitgehend säure- und lösungsmittelbeständig
- silikon-, cadmium- und halogenfrei
- selbstverlöschend
- flammwidrig
- UV-beständig [schwarz]

## PROPERTIES

- air- and liquid-tight
- oil resistant up to +80°C
- benzine resistant
- widely resistant to acids and solvents
- free of silicone, cadmium, halogen
- self-extinguishing
- flame retardant
- UV-resistant [black]

## ANWENDUNGSGEBIETE

- Maschinen- und Anlagenbau
- Fahrzeugbau
- Schienenfahrzeuge
- Schiffsbau
- Automation
- Elektroanlagen

## APPLICATION

- machine and plant constructions
- automotive
- railway industry
- shipbuilding
- automation
- electrical installations



FLEXA No.	FLEXA No.	AD OD				
schwarz black	grau grey	ø	mm	stat dyn	kg m	m
1 0233 202 006	1 0233 201 006	10,0	6,5 x 10,0	13 35	0,020	50
1 0233 202 010	1 0233 201 010	13,0	10,0 x 13,0	20 45	0,030	50
1 0233 202 012	1 0233 201 012	15,8	12,0 x 15,8	35 55	0,035	50
1 0233 202 014	1 0233 201 014	18,5	14,3 x 18,5	40 65	0,045	50
1 0233 202 016	1 0233 201 016	21,2	16,5 x 21,2	45 75	0,060	50
1 0233 202 023	1 0233 201 023	28,5	23,0 x 28,5	55 100	0,100	50
1 0233 202 029	1 0233 201 029	34,5	29,0 x 34,5	65 120	0,125	25
1 0233 202 036	1 0233 201 036	42,5	36,0 x 42,5	90 150	0,150	25
1 0233 202 048	1 0233 201 048	54,5	48,0 x 54,5	100 190	0,220	25
1 0233 232 016		21,2	15,5 x 21,2	45 75	0,060	50
1 0233 232 023		28,5	22,0 x 28,5	55 100	0,090	50
1 0233 232 029		34,5	27,5 x 34,5	65 120	0,115	25
1 0233 232 036		42,5	35,5 x 42,5	90 150	0,130	25
1 0233 232 048		54,5	47,0 x 54,5	100 190	0,200	25

# ROHRflex® PA 6-D

Vollkunststoff-Wellschlauch  
dickwandig  
innen und außen gewellt

Corrugated all-plastic tubing  
thick-walled  
internally and externally corrugated

## MATERIAL

Kunststoff [PA 6]

## EIGENSCHAFTEN

- hohe Querdruckfestigkeit
- luft- und flüssigkeitsdicht
- ölbeständig bis +80° C
- benzinbeständig
- weitgehend säure- und lösungsmittelbeständig
- silikon-, cadmium- und halogenfrei
- flammwidrig
- selbstverlöschend
- UV-beständig

## ANWENDUNGSGEBIETE

- Maschinen- und Anlagenbau
- Fahrzeugbau
- Schienenfahrzeuge
- Schiffsbau
- Automation
- Elektroanlagen

## MATERIAL

plastics [PA 6]

## PROPERTIES

- high cross pressure strength
- air- and liquid-tight
- oil resistant up to +80° C
- benzine resistant
- widely resistant to acids and solvents
- free of silicone, cadmium, halogen
- flame retardant
- self-extinguishing
- UV-resistant

## APPLICATION

- machine and plant constructions
- automotive
- railway industry
- shipbuilding
- automation
- electrical installations



V0 [UL 94]  
 🔥 IP 68 | IP 69K  
 🌡️ -40°C ... +120°C ^ +150°C

EN / IEC 61386-23



UL 1696 | CSA 22.2  
 UR file E86359



EN 45545-2 [HL 3]



ASTM E162|E662  
 SMP 800-C



VIDEO

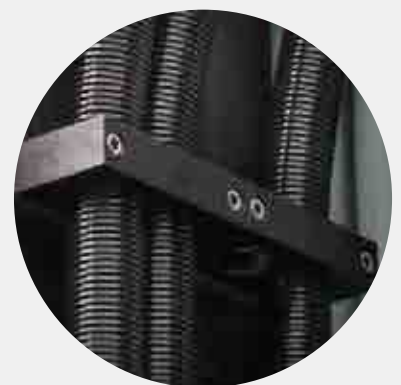

### FLEXA No.

AD  
OD



schwarz black

ø

mm

stat

dyn

kg|m

m



1 0237 202 006	10,0	6,4 x 10,0	15	35	0,020	50
1 0237 202 010	13,0	9,6 x 12,9	25	45	0,030	50
1 0237 202 012	15,8	11,8 x 15,7	35	55	0,040	50
1 0237 202 014	18,5	13,8 x 18,2	40	65	0,060	50
1 0237 202 016	21,2	16,1 x 21,2	50	75	0,080	50
1 0237 202 023	28,5	22,5 x 28,4	60	100	0,130	50
1 0237 202 029	34,5	28,5 x 34,4	70	120	0,150	25
1 0237 202 036	42,5	35,6 x 42,6	100	150	0,200	25
1 0237 202 048	54,5	47,5 x 54,5	110	190	0,260	25



1 0237 232 016	21,2	16,0 x 21,2	50	75	0,070	50
1 0237 232 023	28,5	22,5 x 28,5	60	100	0,120	50
1 0237 232 029	34,5	28,4 x 34,5	70	120	0,160	25
1 0237 232 036	42,5	35,5 x 42,5	100	150	0,180	25
1 0237 232 048	54,5	47,5 x 54,5	110	190	0,260	25



V2 [UL 94]  
 ● IP 68 | 69K  
 ⚡ -40°C ... +120°C ^ +150°C

EN / IEC 61386-23



UL 1696 | CSA 22.2  
 UR file E86359



VIDEO

# ROHRflex® PA 6-S

Vollkunststoff-Wellschlauch  
 innen und außen gewellt

Corrugated all-plastic tubing  
 internally and externally corrugated

## MATERIAL

Kunststoff [PA 6]

## MATERIAL

plastics [PA 6]

## EIGENSCHAFTEN

- luft- und flüssigkeitsdicht
- ölbeständig bis +80°C
- benzinbeständig
- weitgehend säure- und lösungsmittelbeständig
- silikon-, cadmium- und halogenfrei
- flammwidrig
- UV-beständig [schwarz]

## PROPERTIES

- air- and liquid-tight
- oil resistant up to +80°C
- benzine resistant
- widely resistant to acids and solvents
- free of silicone, cadmium, halogen
- flame retardant
- UV-resistant [black]





## ANWENDUNGSGEBIETE

- Maschinen- und Anlagenbau
- Fahrzeugbau
- Schienenfahrzeuge
- Schiffsbau
- Automation
- Elektroanlagen

## APPLICATION

- machine and plant constructions
- automotive
- shipbuilding
- automation
- electrical installations



FLEXA No.	FLEXA No.	AD OD				
schwarz black	grau grey	ø	mm	stat dyn	kg/m	m
						
1 0233 209 006	1 0232 201 006	10,0	6,5 x 10,0	13 35	0,020	50
1 0233 209 010	1 0232 201 010	13,0	10,0 x 13,0	20 45	0,030	50
1 0233 209 012	1 0232 201 012	15,8	12,0 x 15,8	35 55	0,035	50
1 0233 209 014	1 0232 201 014	18,5	14,3 x 18,5	40 65	0,045	50
1 0233 209 016	1 0232 201 016	21,2	16,5 x 21,2	45 75	0,060	50
1 0233 209 023	1 0232 201 023	28,5	23,0 x 28,5	55 100	0,100	50
1 0233 209 029	1 0232 201 029	34,5	29,0 x 34,5	65 120	0,120	25
1 0233 209 036	1 0232 201 036	42,5	36,0 x 42,5	90 150	0,150	25
1 0233 209 048	1 0232 201 048	54,5	48,0 x 54,5	100 190	0,220	25
Kleine Verkaufspackung   small sales pack						
1 0233 209 106		10,0	6,5 x 10,0	13 35	0,020	10
1 0233 209 110		13,0	10,0 x 13,0	20 45	0,030	10
1 0233 209 112		15,8	12,0 x 15,8	35 55	0,035	10
1 0233 209 116		21,2	16,5 x 21,2	45 75	0,060	10
1 0233 209 123		28,5	23,0 x 28,5	55 100	0,100	10
1 0233 209 129		34,5	29,0 x 34,5	65 120	0,120	10
1 0233 209 136		42,5	36,0 x 42,5	90 150	0,150	10
1 0233 209 148		54,5	48,0 x 54,5	100 190	0,220	10

# ROHRflex® PA 6-L | ROHRflex® PA 6-LG

Vollkunststoff-Wellenschlauch  
innen und außen gewellt

Corrugated all-plastic tubing  
internally and externally corrugated

## MATERIAL

Kunststoff [PA modifiziert]

## MATERIAL

plastics [PA modified]

## EIGENSCHAFTEN

- luft- und flüssigkeitsdicht
- ölbeständig bis +80° C
- benzinbeständig
- weitgehend säure- und lösungsmittelbeständig
- silikon-, cadmium- und halogenfrei
- flammwidrig
- UV-beständig [schwarz]
- **ROHRflex® PA 6-LG:** geschlitzt, für nachträgliche Installationen | Reparaturen

## PROPERTIES

- air- and liquid-tight
- oil resistant up to +80° C
- benzine resistant
- widely resistant to acid and solvents
- free of silicone, cadmium, halogen
- flame retardant
- UV-resistant [black]
- **ROHRflex® PA 6-LG:** slitted, for retrofit and repair

## ANWENDUNGSGEBIETE

- Maschinen- und Anlagenbau
- Fahrzeugbau
- Schiffsbau
- Automation
- Elektroanlagen

## APPLICATION

- machine and plant constructions
- automotive
- shipbuilding
- automation
- electrical installations

HB [UL 94]  
 🔥 IP 68 | 69K - IP 40 [PA 6-LG geschlitzt]  
 🌡️ -25° C ... +120° C

ROHRflex® PA 6-L schwarz | black

EN / IEC 61386-23

UL 1696 | CSA 22.2  
 UR file E86359

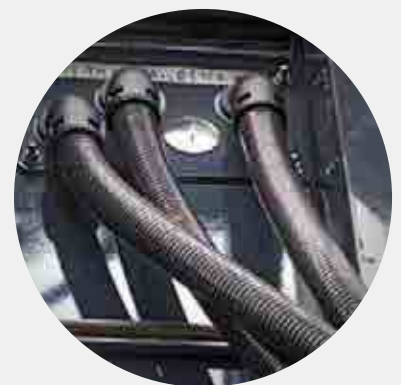

FLEXA No.

FLEXA No.

AD  
OD



schwarz black

grau grey

orange

ø

mm

stat

dyn

kg|m

m

## ROHRflex® PA 6-L



1 0261 202 006	1 0261 201 006	1 0261 209 006	10,0	6,5 x 10,0	13	35	0,020	50
1 0261 202 010	1 0261 201 010	1 0261 209 010	13,0	10,0 x 13,0	20	45	0,024	50
1 0261 202 012	1 0261 201 012	1 0261 209 012	15,8	12,0 x 15,8	35	55	0,034	50
1 0261 202 014	1 0261 201 014	1 0261 209 014	18,5	14,3 x 18,2	40	65	0,050	50
1 0261 202 016	1 0261 201 016	1 0261 209 016	21,2	16,5 x 21,2	45	75	0,056	50
1 0261 202 023	1 0261 201 023		28,5	23,0 x 28,5	55	100	0,100	50
1 0261 202 029			34,5	29,0 x 34,5	65	120	0,122	25
1 0261 202 036			42,5	35,5 x 42,5	90	150	0,145	25
1 0261 202 048			54,5	48,0 x 54,5	100	190	0,225	25



1 0261 232 016	1 0261 231 016	1 0261 239 016	21,2	15,5 x 21,2	45	75	0,056	50
1 0261 232 023	1 0261 231 023	1 0261 239 023	28,5	22,0 x 28,5	55	100	0,090	50
1 0261 232 029	1 0261 231 029	1 0261 239 029	34,5	27,5 x 34,5	65	120	0,120	25
1 0261 232 036	1 0261 231 036	1 0261 239 036	42,5	35,5 x 42,5	90	150	0,165	25
1 0261 232 048	1 0261 231 048	1 0261 239 048	54,5	47,0 x 54,5	100	190	0,225	25

## ROHRflex® PA 6-LG geschlitzt | slitted

1 0261 242 006			10,0	6,5 x 10,0	13	35	0,020	50
1 0261 242 010			13,0	10,0 x 13,0	20	45	0,024	50
1 0261 242 012			15,8	12,0 x 15,8	35	55	0,034	50
1 0261 242 016			21,2	16,5 x 21,2	45	75	0,056	50
1 0261 242 023			28,5	23,0 x 28,5	55	100	0,100	50
1 0261 242 029			34,5	29,0 x 34,5	65	120	0,122	25
1 0261 242 036			42,5	35,5 x 42,5	90	150	0,145	25
1 0261 242 048			54,5	48,0 x 54,5	100	190	0,225	25

# ROHRflex® PA 6-LL

Vollkunststoff-Wellschlauch  
innen und außen gewellt

Corrugated all-plastic tubing  
internally and externally corrugated

HB [UL 94]  
IP 68 | 69K  
-25°C ... +120°C

EN / IEC 61386-23

UL 1696 | CSA 22.2  
UR file E86359



## MATERIAL

Kunststoff [PA modifiziert]

## MATERIAL

plastics [PA modified]

## EIGENSCHAFTEN

- luft- und flüssigkeitsdicht
- ölbeständig bis +80°C
- benzinbeständig
- weitgehend säure- und lösungsmittelbeständig
- silikon-, cadmium- und halogenfrei
- flammwidrig
- UV-beständig [schwarz]

## PROPERTIES

- air- and liquid-tight
- oil resistant up to +80°C
- benzine resistant
- widely resistant to acid and solvents
- free of silicone, cadmium, halogen
- flame retardant
- UV-resistant [black]

## ANWENDUNGSGEBIETE

- Maschinen- und Anlagenbau
- Fahrzeugbau
- Schiffsbau
- Automation
- Elektroanlagen

## APPLICATION

- machine and plant constructions
- automotive
- shipbuilding
- automation
- electrical installations

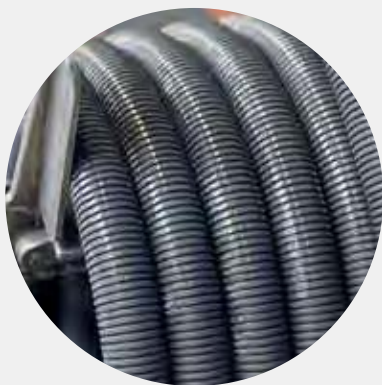

FLEXA No.

FLEXA No.

AD  
OD



schwarz black

grau grey

ø

mm

stat dyn

kg/m

m



1 0267 202 006	1 0267 201 006	10,0	6,5 x 10,0	13	35	0,015	50
1 0267 202 010	1 0267 201 010	13,0	10,0 x 13,0	20	80	0,025	50
1 0267 202 012	1 0267 201 012	15,8	12,0 x 15,8	35	55	0,030	50
1 0267 202 014	1 0267 201 014	18,5	14,3 x 18,5	40	65	0,035	50
1 0267 202 016	1 0267 201 016	21,2	16,5 x 21,2	45	75	0,050	50
1 0267 202 023		28,5	22,0 x 28,5	55	100	0,070	50
1 0267 202 029		34,5	29,0 x 34,5	65	120	0,100	25
1 0267 202 036		42,5	36,0 x 42,5	90	150	0,110	25
1 0267 202 048		54,5	48,0 x 54,5	100	190	0,165	25



1 0267 232 016	1 0267 231 016	21,2	15,5 x 21,2	45	75	0,045	50
1 0267 232 023	1 0267 231 023	28,5	22,0 x 28,5	55	100	0,070	50
1 0267 232 029	1 0267 231 029	34,5	27,5 x 34,5	65	120	0,100	25
1 0267 232 036	1 0267 231 036	42,5	35,5 x 42,5	90	150	0,110	25
1 0267 232 048	1 0267 231 048	54,5	47,0 x 54,5	100	190	0,165	25

# ROHRflex® PA 6-UL-SD

Vollkunststoff-Wellschlauch  
innen und außen gewellt

Corrugated all-plastic tubing  
internally and externally corrugated

## MATERIAL

Kunststoff [PA 6]

## MATERIAL

plastics [PA 6]

V2 [UL 94]

IP 68

-25°C ... +120°C

## EIGENSCHAFTEN

- luft- und flüssigkeitsdicht
- ölbeständig bis +80°C
- benzinbeständig
- weitgehend säure- und lösungsmittelbeständig
- silikon-, cadmium- und halogenfrei
- flammwidrig
- UV-beständig

## PROPERTIES

- air- and liquid-tight
- oil resistant up to +80°C
- benzine resistant
- widely resistant to acids and solvents
- free of silicone, cadmium, halogen
- flame retardant
- UV-resistant

UL 1660 | CSA C22.2 Nr. 227.2.1-14  
NON-METALLIC LIQUID TIGHT  
CONDUIT E495847



VIDEO

## ANWENDUNGSGEBIETE

- Maschinen- und Anlagenbau
- Heizung, Lüftung und Klimatechnik
- Außenanwendungen
- Automation
- Elektroanlagen

## APPLICATION

- machine and plant constructions
- heating, ventilation and air conditioning
- outdoor applications
- automation
- electrical installations



## FLEXA No.

AD  
OD



schwarz black

ø

mm

stat dyn

kg/m

m



1 0238 202 016	1/2"	21,2	16,0 x 21,2	50	75	0,075	50
1 0238 202 023	3/4"	28,5	22,5 x 28,5	60	100	0,120	50
1 0238 202 029	1"	34,5	28,4 x 34,5	70	120	0,155	25
1 0238 202 036	1 1/4"	42,5	35,5 x 42,5	100	150	0,222	25
1 0238 202 048	1 1/2"	54,5	47,0 x 54,5	110	190	0,300	25

# ROHRflex® PA 6-HT

V2 [UL 94]  
 IP 68 | 69K  
 -25°C ... +150°C ^ +170°C

EN / IEC 61386-23



VIDEO

Vollkunststoff-Wellschlauch  
 hochtemperaturbeständig  
 innen und außen gewellt

Corrugated all-plastic tubing  
 high temperature resistant  
 internally and externally corrugated

**MATERIAL**  
 Kunststoff [PA 6]

**MATERIAL**  
 plastics [PA 6]

- EIGENSCHAFTEN**
- luft- und flüssigkeitsdicht
  - ölbeständig bis +80°C
  - benzinbeständig
  - weitgehend säure- und lösungsmittelbeständig
  - silikon-, cadmium- und halogenfrei
  - selbstverlöschend
  - flammwidrig
  - UV-beständig

- PROPERTIES**
- air- and liquid-tight
  - oil resistant up to +80°C
  - benzine resistant
  - widely resistant to acids and solvents
  - free of silicone, cadmium, halogen
  - self-extinguishing
  - flame retardant
  - UV-resistant

- ANWENDUNGSGEBIETE**
- Maschinen- und Anlagenbau
  - Fahrzeugbau
  - Elektroanlagen

- APPLICATION**
- machine and plant constructions
  - automotive
  - electrical installations



FLEXA No.

AD  
OD



schwarz black

ø

mm

stat

dyn

kg/m

m



1 0254 202 006	10,0	6,7 x 10,0	13	35	0,020	50
1 0254 202 010	13,0	9,7 x 12,9	20	45	0,025	50
1 0254 202 012	15,8	12,1 x 15,7	35	55	0,030	50
1 0254 202 016	21,2	16,4 x 21,3	45	75	0,060	50
1 0254 202 023	28,5	22,9 x 28,4	55	100	0,100	50
1 0254 202 029	34,5	28,8 x 34,4	65	120	0,120	25
1 0254 202 036	42,5	36,1 x 42,3	90	150	0,150	25
1 0254 202 048	54,5	47,8 x 54,3	100	190	0,210	25



# ROHRflex® PA 6-CU

Vollkunststoff-Wellenschlauch  
CU-Umflechtung  
innen und außen gewellt

Corrugated all-plastic tubing  
CU wire braiding  
internally and externally corrugated

## MATERIAL

Kunststoff [PA 6]  
verzinnte CU-Umflechtung

## MATERIAL

plastics [PA 6]  
tinned CU-wire braiding

## EIGENSCHAFTEN

- luft- und flüssigkeitsdicht
- ölbeständig bis +80°C
- benzinbeständig
- weitgehend säure- und lösungsmittelbeständig
- silikon-, cadmium- und halogenfrei
- flammwidrig
- Schirmdämpfung bis zu 80 dB im Frequenzbereich bis 30 MHz

## PROPERTIES

- air- and liquid-tight
- oil resistant up to +80°C
- benzine resistant
- widely resistant to acids and solvents
- free of silicone, cadmium, halogen
- flame retardant
- screening attenuation up to 80 dB frequency range up to 30 MHz

## ANWENDUNGSGEBIETE

- Maschinen- und Anlagenbau
- Fahrzeugbau
- Schiffsbau
- Automation
- Elektroanlagen
- EMV-Anwendungen

## APPLICATION

- machine and plant constructions
- automotive
- shipbuilding
- automation
- electrical installations
- emc applications



HB [UL 94]  
IP 68 | IP 69K  
-40°C ... +120°C ^ +150°C

EN / IEC 61386-23



Passender Anschluss

Suitable connector	Seite   page	
RGE-M	03.26	IP 66



FLEXA No.

AD  
OD



ø

mm



stat dyn



kg/m



m



1 0461 702 010*	13,0	10,0 x 14,0	20	45	0,130	50
1 0461 702 012*	15,8	12,5 x 16,8	35	55	0,180	50
1 0461 702 016*	21,2	16,5 x 22,2	45	75	0,250	50
1 0461 702 029*	34,5	29,0 x 35,5	65	120	0,490	25
1 0461 702 036*	42,5	36,0 x 43,5	90	150	0,590	25
1 0461 702 048*	54,5	48,0 x 55,5	100	190	0,780	25

\* Lieferzeit und Mindestbestellmenge auf Anfrage Delivery time and minimum order quantity on request

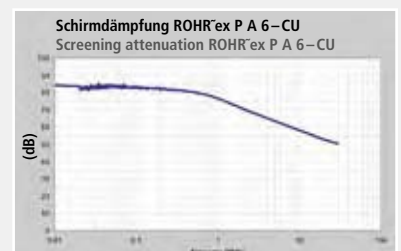



V2 [UL 94]  
 IP 68 | IP 69K  
 -50°C ... +100°C ^ +130°C



VIDEO

# ROHRflex® PA 12

Vollkunststoff-Wellschlauch  
 hochflexibel  
 innen und außen gewellt

Corrugated all-plastic tubing  
 highly flexible  
 internally and externally corrugated

**MATERIAL**  
 Kunststoff [PA 12]

**MATERIAL**  
 plastics [PA 12]

## EIGENSCHAFTEN

- hohe Wechselbiegefestigkeit
- luft- und flüssigkeitsdicht
- öl- und benzinbeständig
- weitgehend säure- | lösungsmittelbeständig
- silikon-, cadmium- und halogenfrei
- selbstverlöschend
- flammwidrig
- UV-beständig

## PROPERTIES

- high alternate bending strength
- air- and liquid-tight
- oil and benzine resistant
- widely resistant to acids and solvents
- free of silicone, cadmium, halogen
- self-extinguishing
- flame retardant
- UV-resistant

## ANWENDUNGSGEBIETE

- Maschinen- und Anlagenbau
- Fahrzeugbau
- Schienenfahrzeuge  
 speziell im Außenbereich
- Schiffsbau
- Automation
- Elektroanlagen

## APPLICATION

- machine and plant constructions
- automotive
- railway industry  
 especially for outside applications
- shipbuilding
- automation
- electrical installations



FLEXA No.

AD  
 OD



schwarz black

ø

mm

stat

dyn

kg/m

m



1 0236 202 006	10,0	6,5 x 10,0	13	35	0,020	50
1 0236 202 010	13,0	10,0 x 13,0	15	45	0,030	50
1 0236 202 012	15,8	12,5 x 15,8	22	55	0,040	50
1 0236 202 014	18,5	14,3 x 18,2	27	65	0,050	50
1 0236 202 016	21,2	16,5 x 21,2	35	75	0,060	50
1 0236 202 023	28,5	23,0 x 28,5	45	100	0,100	50
1 0236 202 029	34,5	29,0 x 34,5	50	120	0,120	25
1 0236 202 036	42,5	36,0 x 42,5	80	150	0,150	25
1 0236 202 048	54,5	48,0 x 54,5	100	190	0,210	25



1 0236 232 016	21,2	15,5 x 21,2	45	75	0,060	50
1 0236 232 023	28,5	22,0 x 28,5	55	100	0,100	50
1 0236 232 029	34,5	27,5 x 34,5	65	120	0,120	25
1 0236 232 036	42,5	35,5 x 42,5	90	150	0,140	25
1 0236 232 048	54,5	47,0 x 54,5	100	190	0,210	25

# ROHRflex® PA 12-D

Vollkunststoff-Wellschlauch  
dickwandig  
innen und außen gewellt

Corrugated all-plastic tubing  
thick-walled  
internally and externally corrugated

## MATERIAL

Kunststoff [PA 12]

## MATERIAL

plastics [PA 12]

## EIGENSCHAFTEN

- hohe Wechselbiegefestigkeit
- gute Isolationseigenschaften
- luft- und flüssigkeitsdicht
- öl- und benzinbeständig
- weitgehend säure- und lösungsmittelbeständig
- silikon-, cadmium- und halogenfrei
- selbstverlöschend
- flammwidrig
- UV-beständig

## PROPERTIES

- high alternate bending strength
- improved insulation properties
- air- and liquid-tight
- oil and benzine resistant
- widely resistant to acids and solvents
- free of silicone, cadmium, halogen
- self-extinguishing
- flame retardant
- UV-resistant

## ANWENDUNGSGEBIETE

- Maschinen- und Anlagenbau
- Fahrzeugbau
- Schienenfahrzeuge  
speziell im Außenbereich
- Schiffsbau
- Automation
- Elektroanlagen

## APPLICATION

- machine and plant constructions
- automotive
- railway industry  
especially for outside applications
- shipbuilding
- automation
- electrical installations



V2 [UL 94]  
 🔥 IP 68 | IP 69K  
 🌡️ -50°C ... +100°C ^ +130°C

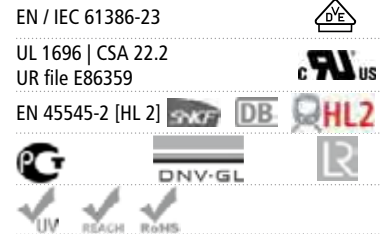

VIDEO



FLEXA No.

AD  
OD



schwarz black

ø

mm

stat

dyn

kg/m

m



1 0258 202 006	10,0	6,0 x 10,0	15	35	0,023	50
1 0258 202 010	13,0	9,5 x 13,0	25	45	0,032	50
1 0258 202 012	15,8	11,5 x 15,8	35	55	0,039	50
1 0258 202 016	21,2	16,0 x 21,2	50	85	0,073	50



1 0258 232 016	21,2	15,0 x 21,2	50	112	0,079	50
1 0258 232 023	28,5	21,5 x 28,5	60	120	0,120	50
1 0258 232 029	34,5	27,0 x 34,5	70	140	0,168	25
1 0258 232 036	42,5	35,0 x 42,5	80	170	0,190	25
1 0258 232 048	54,5	46,5 x 54,5	100	190	0,240	25



# ROHRflex® PA 12-S

V2 [UL 94]  
 ● IP 68 | IP 69K  
 ⚡ -50°C ... +100°C ^ +130°C

EN / IEC 61386-23

UL 1696 | CSA 22.2  
 UR file E86359



VIDEO

Vollkunststoff-Wellschlauch  
 hochflexibel  
 innen und außen gewellt

Corrugated all-plastic tubing  
 highly flexible  
 internally and externally corrugated

## MATERIAL

Kunststoff [PA 12] mod.

## MATERIAL

plastics [PA 12] mod.

## EIGENSCHAFTEN

- hohe Wechselbiegefestigkeit
- luft- und flüssigkeitsdicht
- öl- und benzinbeständig
- weitgehend säure- und lösungsmittelbeständig
- silikon-, cadmium- und halogenfrei
- selbstverlöschend
- flammwidrig
- UV-beständig [schwarz]

## PROPERTIES

- high alternate bending strength
- air- and liquid-tight
- oil and benzine resistant
- widely resistant to acids and solvents
- free of silicone, cadmium, halogen
- self-extinguishing
- flame retardant
- UV-resistant [black]







## ANWENDUNGSGEBIETE

- Maschinen- und Anlagenbau
- Fahrzeugbau
- Schiffsbau
- Automation
- Elektroanlagen

## APPLICATION

- machine and plant constructions
- automotive
- shipbuilding
- automation
- electrical installations



FLEXA No.	FLEXA No.	FLEXA No.	AD OD				
schwarz black	grau grey	orange	ø	mm	stat dyn	kg/m	m
							
1 0242 202 006	1 0236 201 006	1 0236 209 006	10,0	6,5 x 10,0	13 35	0,020	50
1 0242 202 010	1 0236 201 010	1 0236 209 010	13,0	10,0 x 13,0	15 45	0,030	50
1 0242 202 012	1 0236 201 012	1 0236 209 012	15,8	12,5 x 15,8	22 55	0,040	50
1 0242 202 014	1 0236 201 014		18,5	14,3 x 18,2	27 65	0,050	50
1 0242 202 016	1 0236 201 016	1 0236 209 016	21,2	16,5 x 21,2	35 75	0,060	50
1 0242 202 023	1 0236 201 023	1 0236 209 023	28,5	23,0 x 28,5	45 100	0,100	50
1 0242 202 029	1 0236 201 029	1 0236 209 029	34,5	29,0 x 34,5	50 120	0,120	25
1 0242 202 036	1 0236 201 036	1 0236 209 036	42,5	36,0 x 42,5	80 150	0,150	25
1 0242 202 048	1 0236 201 048	1 0236 209 048	54,5	48,0 x 54,5	100 190	0,210	25
							
1 0242 232 016			21,2	15,5 x 21,2	45 75	0,060	50
1 0242 232 023			28,5	22,0 x 28,5	55 100	0,100	50
1 0242 232 029			34,5	27,5 x 34,5	65 120	0,120	25
1 0242 232 036			42,5	35,5 x 42,5	90 150	0,140	25
1 0242 232 048			54,5	47,0 x 54,5	100 190	0,210	25

# ROHRflex® PA 12-SD

Vollkunststoff-Wellenschlauch  
dickwandig, hochflexibel  
innen und außen gewellt

Corrugated all-plastic tubing  
thick-walled, highly flexible  
internally and externally corrugated

V2 [UL 94]  
 IP 68 | IP 69K  
 -50°C ... +100°C ^ +130°C

## MATERIAL

Kunststoff [PA 12] mod.

## MATERIAL

plastics [PA 12] mod.

## EIGENSCHAFTEN

- hohe Querdruckbelastbarkeit
- hohe Wechselbiegefestigkeit
- gute Isolationseigenschaften
- luft- und flüssigkeitsdicht
- öl- und benzinbeständig
- weitgehend säure- und lösungsmittelbeständig
- silikon-, cadmium- und halogenfrei
- selbstverlöschend
- flammwidrig
- UV-beständig

## PROPERTIES

- high vross pressure strength
- high alternate bending strength
- improved insulation properties
- air- and liquid-tight
- oil and benzine resistant
- widely resistant to acids and solvents
- free of silicone, cadmium, halogen
- self-extinguishing
- flame retardant
- UV-resistant

## ANWENDUNGSGEBIETE

- Maschinen- und Anlagenbau
- Fahrzeugbau
- Schiffsbau
- Automation
- Elektroanlagen

## APPLICATION

- machine and plant constructions
- automotive
- shipbuilding
- automation
- electrical installations

EN / IEC 61386-23

UL 1696 | CSA 22.2  
UR file E86359



VIDEO

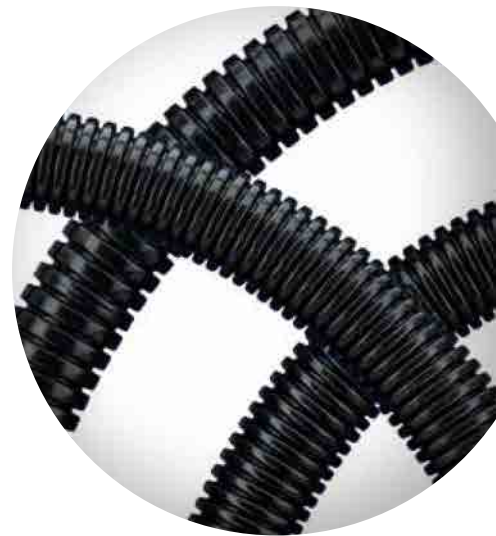

### FLEXA No.

AD  
OD



schwarz black

ø

mm

stat dyn

kg/m

m



1 0243 202 006	10,0	6,0 x 10,0	15	35	0,023	50
1 0243 202 010	13,0	9,5 x 13,0	25	45	0,032	50
1 0243 202 012	15,8	11,5 x 15,8	35	55	0,039	50
1 0243 202 016	21,2	16,0 x 21,2	50	85	0,073	50



1 0243 232 016	21,2	15,0 x 21,2	50	112	0,079	50
1 0243 232 023	28,5	21,5 x 28,5	60	120	0,120	50
1 0243 232 029	34,5	27,0 x 34,5	70	140	0,168	25
1 0243 232 036	42,5	35,0 x 42,5	80	170	0,190	25
1 0243 232 048	54,5	46,5 x 54,5	100	190	0,240	25



V2 [UL 94]  
 IP 68 | IP 69K  
 -50°C ... +100°C ^ +130°C

EN / IEC 61386-23



EN 45545-2 [HL 3]



VIDEO

# ROHRflex® PA 12-F

Vollkunststoff-Wellschlauch  
 hochflexibel, flammwidrig  
 innen und außen gewellt

Corrugated all-plastic tubing  
 highly flexible, flame retardant  
 internally and externally corrugated

## MATERIAL

Kunststoff [PA 12]

## MATERIAL

plastics [PA 12]

## EIGENSCHAFTEN

- hohe Wechselbiegefestigkeit
- gute Isolationseigenschaften
- luft- und flüssigkeitsdicht
- ölbeständig bis +80°C
- benzinbeständig
- weitgehend säure- und lösungsmittelbeständig
- silikon-, cadmium- und halogenfrei
- selbstverlöschend
- flammwidrig
- UV-beständig
- EN 45545-2 HL3 für R22/R23

## PROPERTIES

- high alternate bending strength
- improved insulation properties
- air- and liquid-tight
- oil resistant up to +80°C
- benzine resistant
- widely resistant to acids and solvents
- free of silicone, cadmium, halogen
- self-extinguishing
- flame retardant
- UV-resistant
- EN 45545-2 HL3 for R22/R23

## ANWENDUNGSGEBIETE

- Fahrzeugbau
- Schienenfahrzeuge
- Elektroanlagen

## APPLICATION

- automotive
- railway industry
- electrical installations



FLEXA No.

AD  
OD



schwarz black

ø

mm

stat

dyn

kg|m

m



1 0249 202 006*	10,0	6,5 x 10,0	13	35	0,020	50
1 0249 202 010*	13,0	10,0 x 13,0	15	45	0,025	50
1 0249 202 012*	15,8	12,0 x 15,8	22	55	0,030	50
1 0249 202 016*	21,2	16,5 x 21,2	35	75	0,060	50



1 0249 232 016*	21,2	15,5 x 21,2	45	75	0,080	50
1 0249 232 023*	28,5	22,0 x 28,5	55	100	0,110	50
1 0249 232 029*	34,5	27,5 x 34,5	65	120	0,130	25
1 0249 232 036*	42,5	36,0 x 42,5	90	150	0,150	25
1 0249 232 048*	54,5	47,0 x 54,5	100	190	0,220	25

\* Lieferzeit und Mindestbestellmenge auf Anfrage Delivery time and minimum order quantity on request

# ROHRflex® PA 12 - FD

Vollkunststoff-Wellschlauch  
dickwandig  
innen und außen gewellt

Corrugated all-plastic tubing  
thick-walled  
internally and externally corrugated



V2 [UL 94]  
 IP 68 | IP 69K  
 -50°C ... +100°C ^ +130°C

## MATERIAL

Kunststoff [PA 12] mod.

## MATERIAL

plastics [PA 12] mod.

## EIGENSCHAFTEN

- hohe Wechselbiegefestigkeit
- gute Isolationseigenschaften
- luft- und flüssigkeitsdicht
- ölbeständig bis +80° C
- benzinbeständig
- weitgehend säure- und lösungsmittelbeständig
- silikon-, cadmium- und halogenfrei
- selbstverlöschend
- flammwidrig
- UV-beständig
- EN 45545-2 HL3 für den Innen- und Außenbereich (R22/R23)

## PROPERTIES

- high alternate bending strength
- improved isolation strength
- air- and liquid-tight
- oil resistant up to +80° C
- benzine resistant
- widely resistant to acids and solvents
- free of silicone, cadmium, halogen
- self-extinguishing
- flame retardant
- UV-resistant
- EN 45545-2 HL3 for inside and outside areas (R22/R23)

## ANWENDUNGSGEBIETE

- Schienenfahrzeuge für statische und dynamische Verlegung [speziell für Außenanwendungen]

## APPLICATION

- railway industry for static and dynamic applications [especially for outside applications]

EN / IEC 61386-23



EN 45545-2 [HL 3]



VIDEO

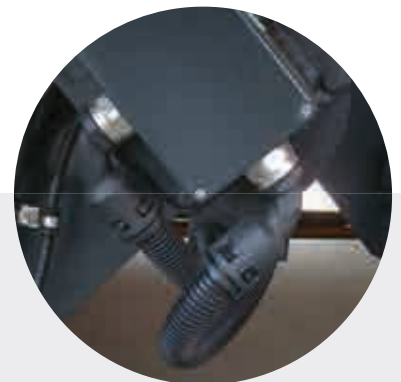

### FLEXA No.

AD  
OD



mm



stat dyn



kg/m



m

schwarz black



1 0252 202 010	13,0	9,5 x 13,0	25	45	0,032	50
1 0252 202 012	15,8	11,5 x 15,8	35	55	0,039	50
1 0252 202 016	21,2	16,0 x 21,2	50	85	0,073	50



1 0252 232 016	21,2	15,0 x 21,2	50	112	0,079	50
1 0252 232 023	28,5	21,5 x 28,5	60	120	0,120	50
1 0252 232 029	34,5	27,0 x 34,5	70	140	0,168	25
1 0252 232 036	42,5	35,0 x 42,5	80	170	0,190	25
1 0252 232 048	54,5	46,5 x 54,5	100	190	0,240	25



HB [UL 94]  
 IP 68 | IP 69K  
 -50°C ... +100°C ^ +130°C



VIDEO

# ROHRflex® PA 12-ESD

Vollkunststoff-Wellschlauch  
 antistatisch, ableitfähig, hochflexibel  
 innen und außen gewellt

Corrugated all-plastic tubing  
 antistatic, dissipative, highly flexible  
 internally and externally corrugated

**MATERIAL**  
 Kunststoff [PA 12]

**MATERIAL**  
 plastics [PA 12]

- EIGENSCHAFTEN**
- hohe Wechselbiegefestigkeit
  - gute Isolationseigenschaften
  - luft- und flüssigkeitsdicht
  - öl- und benzinbeständig
  - weitgehend säure- und lösungsmittelbeständig
  - silikon-, cadmium- und halogenfrei
  - UV-beständig

- PROPERTIES**
- high alternate bending strength
  - improved insulation properties
  - air- and liquid-tight
  - oil and benzine resistant
  - widely resistant to acids and solvents
  - free of silicone, cadmium, halogen
  - UV-resistant

- ANWENDUNGSGEBIETE**
- Maschinen- und Anlagenbau
  - Fahrzeugbau
  - Schienenfahrzeuge
  - Elektroanlagen
  - EX-Bereich

- APPLICATION**
- machine and plant constructions
  - automotive
  - railway industry
  - electrical installations
  - ex area



FLEXA No.

AD  
OD



schwarz black

ø

mm

stat dyn

kg/m

m



1 0259 202 016	21,2	16,5 x 21,2	45	75	0,075	50
1 0259 202 023	28,5	23,0 x 28,5	55	100	0,108	50
1 0259 202 029	34,5	29,0 x 34,5	65	120	0,132	25
1 0259 202 036	42,5	36,0 x 42,5	90	150	0,145	25



# ROHRflex® PP

Vollkunststoff-Wellschlauch  
innen und außen gewellt

Corrugated all-plastic tubing  
internally and externally corrugated

## MATERIAL

Kunststoff [PP]

## MATERIAL

plastics [PP]

Die Materialeigenschaften sind  
unabhängig von der Luftfeuchtigkeit

Material properties do not depend  
on air humidity

## EIGENSCHAFTEN

- luft- und flüssigkeitsdicht
- widerstandsfähig gegen wässrige Lösungen [Salze, Säuren, Alkalien]
- weitgehend beständig gegen Lösungsmittel
- ozonbeständig
- silikon- und cadmiumfrei
- UV-beständig
- flammgeschützt

## PROPERTIES



- air- and liquid-tight
- resistant against hydrous solutions, acids and alkalis
- widely resistant to solvents
- ozon resistant
- free of silicone and cadmium
- UV-resistant
- flame retardant

## ANWENDUNGSGEBIETE

- Maschinen- und Anlagenbau
- Fahrzeugbau
- Schiffsbau
- Automation
- Elektroanlagen

## APPLICATION

- machine and plant constructions
- automotive
- shipbuilding
- automation
- electrical installations

HB [UL 94]  
 IP 68 | IP 69K  
 -40°C ... +120°C ^ +150°C

EN / IEC 61386-23



VIDEO

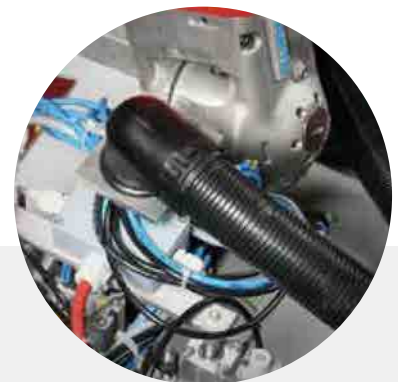

FLEXA No.

AD  
OD



schwarz black

ø

mm

stat dyn

kg/m

m



1 0231 002 006	10,0	6,9 x 9,9	15	45	0,010	50
1 0231 002 010	13,0	9,8 x 12,9	20	60	0,020	50
1 0231 002 012	15,8	12,2 x 15,7	25	75	0,035	50
1 0231 002 014	18,5	14,3 x 18,2	35	105	0,040	50
1 0231 002 016	21,2	16,6 x 21,0	40	120	0,050	50
1 0231 002 023	28,5	23,0 x 28,4	45	135	0,090	50
1 0231 002 029	34,5	28,9 x 34,3	55	165	0,110	25
1 0231 002 036	42,5	36,0 x 42,5	65	195	0,160	25
1 0231 002 048	54,5	48,0 x 54,5	80	240	0,210	25

# ROHRflex® PU

HB [UL 94]  
 IP 68 | IP 69K  
 -40°C ... +120°C ^ +150°C



VIDEO

Vollkunststoff-Wellschlauch  
 innen und außen gewellt

Corrugated all-plastic tubing  
 internally and externally corrugated

## MATERIAL

Kunststoff [PU]

## MATERIAL

plastics [PU]

## EIGENSCHAFTEN

- luft- und flüssigkeitsdicht
- öl-, benzin- und fettbeständig
- weitgehend lösungsmittel- und säurebeständig
- halogen-, silikon- und cadmiumfrei
- hohe Zähigkeit und Abriebbeständigkeit
- hervorragendes Verhalten bei tiefen Temperaturen
- sehr flexibel
- mikrobebeständig
- UV-beständig

## PROPERTIES

- air- and liquid-tight
- oil, benzine and grease resistant
- widely resistant to acids and solvents
- free of silicone, cadmium, halogen
- high tenacity and abrasion resistance
- outstanding qualities at low temperatures
- very flexible
- microbe resistant
- UV-resistant

## ANWENDUNGSGEBIETE

- Maschinen- und Anlagenbau
- Fahrzeugbau  
 speziell für Motorinstallationen
- Schiffsbau
- Automation
- Elektroanlagen

## APPLICATION

- machine and plant constructions
- automotive  
 especially for engine installations
- shipbuilding
- automation
- electrical installations



### FLEXA No.

AD  
OD



schwarz black

ø

mm

stat

dyn

kg|m

m



1 0289 902 010	13,0	8,8 x 13,0	15	40	0,040	50
1 0289 902 012	15,8	11,4 x 15,8	22	55	0,050	50



1 0289 932 016	21,2	15,2 x 21,2	35	75	0,060	50
1 0289 932 023	28,5	22,0 x 28,5	45	100	0,140	50
1 0289 932 029	34,5	27,5 x 34,5	50	120	0,165	25
1 0289 932 036	42,5	35,5 x 42,5	80	150	0,170	25
1 0289 932 048	54,5	47,0 x 54,5	100	190	0,230	25

# ROHRflex® MULTI

Vollkunststoff-Wellenschlauch  
innen und außen gewellt  
Kabelsammler für große  
Kabelmengen

Corrugated all-plastic tubing  
internally and externally corrugated  
cable buncher for large  
quantity of cables



**HB [UL 94]**  
 -40°C ... +120°C ^ +150°C PA 6  
 -50°C ... +100°C ^ +130°C PA 12

## MATERIAL

ROHRflex® MULTI: Kunststoff PA 6  
 ROHRflex® MULTI: Kunststoff PA 12

## MATERIAL

ROHRflex® MULTI: plastics PA 6  
 ROHRflex® MULTI: plastics PA 12

## EIGENSCHAFTEN

- trittfest
- luft- und flüssigkeitsdicht
- silikon-, cadmium- und halogenfrei
- flammwidrig
- UV-beständig [schwarz]
- HB nach UL 94

**ROHRflex® MULTI PA 6**

- ölbeständig bis +80°C
- benzinbeständig
- weitgehend säure- und lösungsmittelbeständig

**ROHRflex® MULTI PA 12**

- öl- und benzinbeständig
- weitgehend säure- und lösungsmittelbeständig
- besonders geeignet bei häufigem Biegewechsel

## PROPERTIES

- non-crush
- air- and liquid-tight
- free of silicone, cadmium, halogen
- flame retardant
- UV-resistant [black]
- HB acc. to UL 94

**ROHRflex® MULTI PA 6**

- oil resistant up to +80°C
- benzene resistant
- widely resistant to acid and solvents

**ROHRflex® MULTI PA 12**

- oil and benzene resistant
- widely resistant to acids and solvents
- especially suitable for applications with frequently reversed bending cycles

## ANWENDUNGSGEBIETE

- Maschinen- und Anlagenbau
- Fahrzeugbau
- Schienenfahrzeuge
- Schiffsbau
- Automation
- Elektroanlagen

## APPLICATION

- machine and plant constructions
- automotive
- railway industry
- shipbuilding
- automation
- electrical installations



Passende Anschlüsse  
Suitable connectors

Suitable connectors	Seite   page	
Multi-GFP	03.44	IP 54
Multi-WFP	03.45	IP 54



FLEXA No.	FLEXA No.	LW NW	mm	stat	dyn	kg/m	m
schwarz black	grau grey	ø					

### ROHRFLEX® MULTI PA 6

1 0206 202 056		56	56,3 x 67,2	130	270	0,460	10
1 0206 202 070	1 0206 201 070	70	66,5 x 79,2	170	350	0,500	10
1 0206 202 095	1 0206 201 095	95	91,0 x 106,0	225	450	0,950	10

### ROHRFLEX® MULTI PA 12

1 0207 202 056		56	56,3 x 67,2	130	270	0,400	10
1 0207 202 070	1 0207 201 070	70	66,5 x 79,2	170	350	0,460	10
1 0207 202 095	1 0207 201 095	95	91,0 x 106,0	225	450	0,850	10

# ROHRflex® - Duo PA 6

HB [UL 94]  
 IP 40  
 -40°C ... +120°C ^ +150°C



Passende Anschlüsse  
 Suitable connectors

	RQG-Duo-M	03.25
	GMK-Duo	09.07

Vollkunststoff-Wellschlauch  
 innen und außen gewellt  
 zweiteilig, der Länge nach teilbar und  
 wiederverschließbar

Corrugated all-plastic tubing  
 internally and externally corrugated  
 two-piece, longitudinal dividable  
 and recloseable

**MATERIAL**  
 Kunststoff [PA 6]

**MATERIAL**  
 plastics [PA 6]

- EIGENSCHAFTEN**
- weitgehend chemikalienbeständig
  - silikon-, cadmium- und halogenfrei
  - selbstverlöschend
  - flammwidrig
  - flexibel
  - biegewechselbeständig
  - UV-beständig

- PROPERTIES**
- good chemical resistance
  - free of silicone, cadmium, halogen
  - self-extinguishing
  - flame retardant
  - flexible
  - bending strength
  - UV-resistant

- ANWENDUNGSGEBIETE**
- nachträgliche Installation und Reparaturen
  - Schaltschrankbau
  - schutzisolierte Elektroinstallationen im  
 Maschinen- und Anlagenbau  
 nach DIN EN 60204
  - Elektroanlagen

- APPLICATION**
- for retrofit and repair
  - switch cabinet construction
  - insulated electrical installations  
 for application rules machine and plant  
 constructions acc. to DIN EN 60204
  - electrical installations

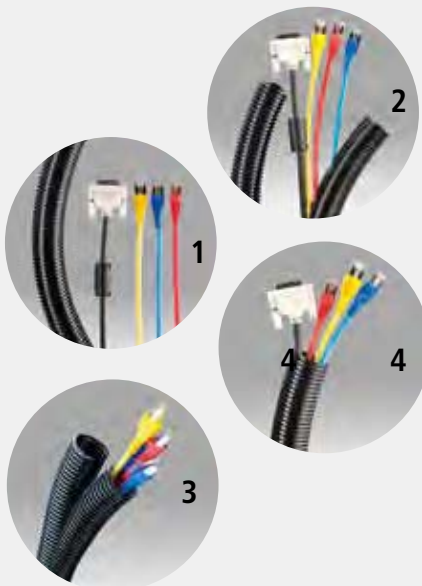

FLEXA No.	AD OD	mm	stat dyn	kg/m	m
schwarz black	ø	mm	stat dyn	kg/m	m
1 0269 202 006	10,0	5,6 x 10,3	30 90	0,030	50
1 0269 202 008	13,0	8,5 x 13,3	35 110	0,040	50
1 0269 202 010	15,8	11,0 x 16,0	40 120	0,060	50
1 0269 202 014	21,2	15,1 x 21,3	55 170	0,070	50
1 0269 202 019	—	19,1 x 25,6	75 230	0,100	50
1 0269 202 020	28,5	21,9 x 28,5	95 290	0,110	50
1 0269 202 024	—	24,0 x 31,7	110 330	0,130	25
1 0269 202 026	34,5	27,2 x 35,0	120 360	0,160	25
1 0269 202 032	42,5	32,0 x 42,5	135 410	0,200	25
1 0269 202 043	54,5	43,9 x 53,9	140 420	0,270	25
1 0269 202 061	79,0	62,2 x 79,0	200 600	0,540	10
Kleine Verkaufspackung   small sales pack					
1 0269 202 106	10,0	5,6 x 10,3	30 90	0,030	10
1 0269 202 108	13,0	8,5 x 13,3	35 110	0,040	10
1 0269 202 110	15,8	11,0 x 16,0	40 120	0,060	10
1 0269 202 114	21,2	15,1 x 21,3	55 170	0,070	10
1 0269 202 120	28,5	21,9 x 28,5	95 290	0,110	10
1 0269 202 126	34,5	27,2 x 35,0	120 360	0,160	5
1 0269 202 132	42,5	32,0 x 42,5	135 410	0,200	5
1 0269 202 143	54,5	43,9 x 53,9	140 420	0,270	5
1 0269 202 161	79,0	62,2 x 79,0	200 600	0,540	5

# ROHRflex® - Duo PP

Vollkunststoff-Wellenschlauch innen und außen gewellt zweiteilig, der Länge nach teilbar und wiederverschließbar

Corrugated all-plastic tubing internally and externally corrugated two-piece, longitudinal dividable and recloseable

V2 [UL 94]  
 IP 40  
 -25°C ... +135°C ^ +150°C

## MATERIAL

Kunststoff [PP]

## EIGENSCHAFTEN

- weitgehend chemikalienbeständig
- phosphor- und cadmiumfrei
- selbstverlöschend
- flammwidrig
- flexibel
- UV-beständig

## ANWENDUNGSGEBIETE

- nachträgliche Installation und Reparaturen
- Schaltschrankbau
- schutzisolierte Elektroinstallationen im Maschinen- und Anlagenbau nach DIN EN 60204
- Elektroanlagen

## MATERIAL

plastics [PP]

## PROPERTIES

- good chemical resistance
- free of phosphor and cadmium
- self-extinguishing
- flame retardant
- flexible
- UV-resistant

## APPLICATION

- for retrofit and repair
- switch cabinet construction
- insulated electrical installations for application rules machine and plant constructions acc. to DIN EN 60204
- electrical installations



Passende Anschlüsse  
 Suitable connectors

	Seite   page
RQG-Duo-M	03.25
GMK-Duo	09.07



### FLEXA No.

schwarz black

AD  
OD

ø



mm



stat dyn



kg/m



m



1 0270 032 006	10,0	5,6 x 10,3	30	90	0,020	50
1 0270 032 008	13,0	8,5 x 13,3	40	120	0,030	50
1 0270 032 010	15,8	11,0 x 16,0	50	150	0,040	50
1 0270 032 014	21,2	15,1 x 21,3	65	200	0,060	50
1 0270 032 019	—	19,6 x 25,4	75	230	0,070	50
1 0270 032 020	28,5	21,6 x 28,1	80	240	0,090	50
1 0270 032 024	—	24,0 x 31,5	100	300	0,110	25
1 0270 032 026	34,5	26,8 x 34,4	110	330	0,130	25
1 0270 032 032	42,5	31,8 x 42,7	145	440	0,160	25
1 0270 032 043	54,5	43,9 x 53,9	150	450	0,230	25
1 0270 032 061	79,0	60,5 x 78,0	220	660	0,440	10

Kleine Verkaufspackung | small sales pack

1 0270 032 106	10,0	5,6 x 10,3	30	90	0,020	10
1 0270 032 108	13,0	8,5 x 13,3	40	120	0,030	10
1 0270 032 110	15,8	11,0 x 16,0	50	150	0,040	10
1 0270 032 114	21,2	15,1 x 21,3	65	200	0,060	10
1 0270 032 120	28,5	21,6 x 28,1	80	240	0,090	10
1 0270 032 126	34,5	26,8 x 34,4	110	330	0,130	5
1 0270 032 132	42,5	31,8 x 42,7	145	440	0,160	5
1 0270 032 143	54,5	43,9 x 53,9	150	450	0,220	5
1 0270 032 161	79,0	60,5 x 78,0	220	660	0,440	5

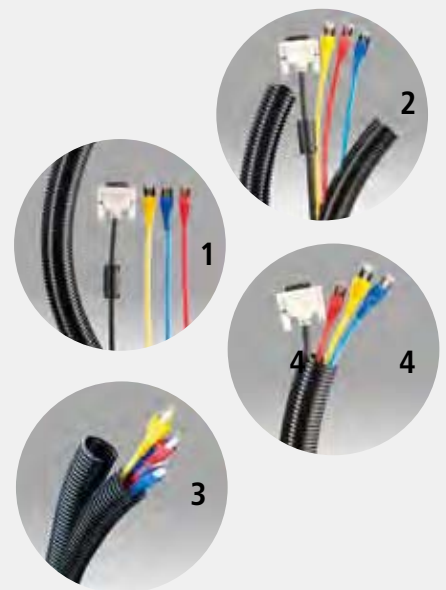

HB [UL 94]  
 IP 40  
 -40°C ... +100°C ^ +130°C



## FLEXAzip

Vollkunststoff-Wellschlauch  
 Rohrflex PA geschlitzt  
 innen und außen gewellt  
 für nachträgliche Installationen

### MATERIAL

Schutzschlauch: Kunststoff [PA]  
 Verschlussprofil: TPE

### INHALT

10 Meter Wellschlauch geschlitzt  
 Rohrflex PA  
 10 Meter Verschlussprofil  
 1 Stück Montagewerkzeug

### EIGENSCHAFTEN

- ölbeständig bis +80° C
- benzinbeständig
- weitgehend säure- und lösungsmittelbeständig
- silikon-, cadmium- und halogenfrei
- selbstverlöschend
- flammwidrig
- UV-beständig

### ANWENDUNGSGEBIETE

- nachträgliche Installationen
- Maschinen- und Anlagenbau
- Gerätebau
- Automation
- Elektroanlagen

Patentiertes System

Corrugated all-plastic tubing  
 Rohrflex PA slitted  
 internally and externally corrugated  
 for additional installation

### MATERIAL

Conduit: plastics [PA]  
 Closing profile: TPE

### CONTENTS

10 meter slitted corrugated  
 plastic conduit Rohrflex PA  
 10 meter closing profile  
 1 piece mounting tool

### PROPERTIES

- oil resistant up to +80° C
- benzine resistant
- widely resistant to acids and solvents
- free of silicone, cadmium, halogen
- self-extinguishing
- flame retardant
- UV-resistant

### APPLICATION

- for retrofit and repair
- machine and Plant Constructions
- shipbuilding
- automation
- electrical installations

Patent right for the system



VIDEO



### FLEXA No.

schwarz black

AD  
OD

ø



mm



stat

dyn



kg/m



m



1 0255 202 110	13,0	9,8 x 12,9	20	60	0,030	10
1 0255 202 112	15,8	12,1 x 15,8	25	80	0,040	10
1 0255 202 116	21,2	16,5 x 21,3	40	120	0,060	10
1 0255 202 123	28,5	22,9 x 28,5	45	140	0,100	10
1 0255 202 129	34,5	28,6 x 34,4	55	170	0,120	10
1 0255 202 136	42,5	36,0 x 42,2	65	200	0,150	10
1 0255 202 148	54,5	47,7 x 54,2	80	240	0,210	10

## ROHRflex® - Cutter

Zum Trennen der ROHRflex®-Schläuche

For cutting of ROHRflex® tubings

### MATERIAL

Cutter A Kunststoff | Cutter B Alu-Druckguss  
Klingen Stahl

### MATERIAL

Cutter A plastics | Cutter B alu-die cast metal  
spare blades steel



FLEXA No.	Typ   type	AD   OD	St.   pcs.
		ø mm	
1 0433 000 010	A	10,0 - 34,5	1
1 0433 000 011	B	21,2 - 54,5	1
Ersatzklingen   Cutter spare blades			
1 0433 001 010	A	10,0 - 34,5	1
1 0433 001 011	B	21,2 - 54,5	1

## ROHRflex® - Slitter

Spezial-Messer zum nachträglichen  
Schlitzen von ROHRflex®-Wellschläuchen

Special knife for longitudinal slitting  
of the ROHRflex® tubings

### MATERIAL

Kunststoff | Metall

### MATERIAL

plastics | metal



FLEXA No.	St.   pcs.
Ersatzklinge   Cutter spare blade	
1 0434 001 001	1

## FLEXAzip® - Montagewerkzeug | Mounting tool

Montagewerkzeug für geschlitzte  
ROHRflex®-Wellschläuche FLEXAzip®

Mounting tool for slitted ROHRflex®  
tubings FLEXAzip®

### MATERIAL

Kunststoff

### MATERIAL

plastics



FLEXA No.	AD   OD	St.   pcs.
	ø mm	
1 5030 211 507	10,0 - 13,0	1
1 5030 211 516	15,8 - 28,5	1
1 5030 211 529	34,5 - 54,5	1

# 03

## ANSCHLUSSTECHNIK CONNECTORS



ZUORDNUNGSTABELLE  
ASSIGNMENT TABLE

Nenngröße AD Schlauch-Außen-ø	Metr. Gewinde EN 60423	PG Gewinde DIN 40430
Trade Size OD Tubing outer ø	metric thread EN 60423	PG thread DIN 40430
10,0	M 10 x 1,0	PG 7
10,0	M 12 x 1,5	
13,0	M 12 x 1,5	PG 9
13,0	M 16 x 1,5	
15,8	M 16 x 1,5	PG 11
15,8	M 20 x 1,5	
18,5	M 20 x 1,5	PG 13,5
21,2	M 20 x 1,5	PG 16
21,2	M 25 x 1,5	
28,5	M 25 x 1,5	PG 21
28,5	M 32 x 1,5	
34,5	M 32 x 1,5	PG 29
34,5	M 40 x 1,5	
42,5	M 40 x 1,5	PG 36
42,5	M 50 x 1,5	
54,5	M 50 x 1,5	PG 48
54,5	M 63 x 1,5	



EWW Anwendungen  
EMC Applications



VIDEO



Typenbezeichnung

Types

R Q G K Z E – M

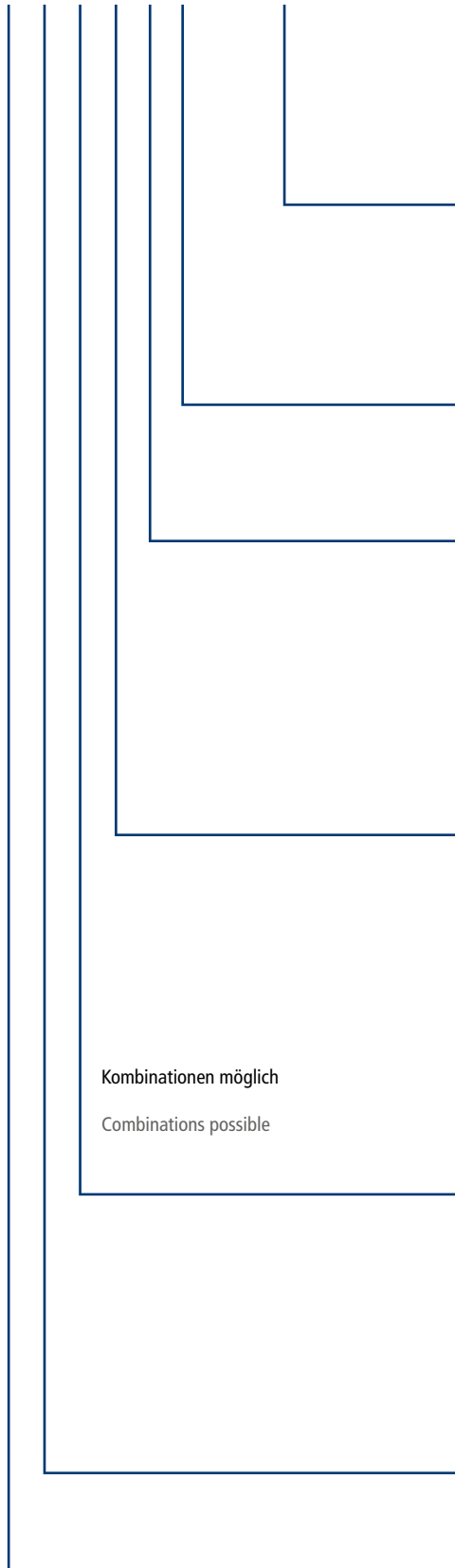

C	CTG   Gas-Gewinde	CTG   gas thread
F	Flanschanschluss	flange connection
M	Metrisches Gewinde	metric thread
N	NPT-Gewinde	NPT thread
P	PG-Gewinde	PG thread
S	Steckanschluss	plug-type connection
U	UNEF-Gewinde	UNEF thread
E	EMV	emc
ED	EMV-Kontaktfeder	emc contacting spring
1	Konisch dichtend	conically sealed
2	Innengewinde	inner thread
3	Innengewinde und Konisch dichtend	inner thread and conically sealed
4	Langes Anschlussgewinde	long connection thread
DR	Drehbares Gewinde	turnable thread
Z	Zugentlastung	strain relief
D	Deckel für Halter RQH	cover for clamp RQH
G	Halter mit Deckel	clamp with cover
K	Kunststoffgehäuse mit Metallgewinde	plastic housing with metal thread
PRO	Protektor	protector
R	Reduzierung	reducer
ST	Installationsrohr	solid tube
V	Verbindungssteg	connecting element
45°	45°	45°
90°	90°	90°
A	Abdeckkappe	terminal sleeve
B	Bogen	bend
E	Endtülle	end cap
F	Flanschanschluss	flange connection
G	Gerade	straight type
H	Halter	tubing clamp
K	Kupplung	coupler
M	Massivhalter	heavy tubing clamp
S	Schlauchhalter einteilig	tubing clamp   one-part
T	T-Verteiler	T type connector
W	Winkel	elbow type
Y	Y-Verteiler	Y type connector
Q	FLEXAquick®	FLEXAquick®
RQL	FLEXAlight	FLEXAlight
R	ROHRflex®	ROHRflex®

Kombinationen möglich

Combinations possible

**RQG-M|P|C|N**  
Kunststoffverschraubung  
Plastic connector

03. 6



**RQ GK2-M|P**  
Kunststoffverschraubung mit Messinggewinde  
Plastic connector with brass thread

03.21



**RQ GK-M|P**  
Kunststoffverschraubung mit Messinggewinde  
Plastic connector with brass thread

03. 8



**RQ GK3-M|U**  
Kunststoffverschraubung  
Plastic connector

03.22



**RQ G1-M|P|C|N**  
Kunststoffverschraubung  
Plastic connector

03. 9



**RQ GZ-S**  
Kunststoffverschraubung  
Zugentlastung  
Plastic connector  
Strain relief

03.23



**RQ LG1-M|P|N**  
Kunststoffverschraubung  
Plastic connector

03.11



**RQ G1-S**  
Kunststoffverschraubung  
Plastic connector

03.23



**RQ GKZP-M**  
**RQ GKZ-M|P**  
**RQ GKZE-M**  
Kunststoffverschraubung mit Dichteinsatz  
und Messinggewinde  
Plastic connector with sealing  
and brass thread

03.12



**RQ GST-M**  
Kunststoffverbindung auf Installationsrohr  
Plastic connector to solid tube

03.24



**RQ GKZED-M**  
Kunststoffverschraubung mit Dichteinsatz,  
Federkontaktierung und Messinggewinde  
Plastic connector with sealing,  
contacting spring and brass thread

03.16



**RQ G-Duo-M**  
Kunststoffverschraubung  
teilbar  
Plastic connector  
separable

03.25



**RQ GZ-M|P|N**  
Kunststoffverschraubung  
Plastic connector

03.17



**RGE-M**  
Metallverschraubung für EMV Anwendungen  
Metal connector for EMC applications

03.26



**RQ GZ1-M|P|N**  
Kunststoffverschraubung  
Plastic connector

03.18



**Multi-GFP**  
Kunststoffanschluss für  
Kabelsammler ROHRflex-Multi  
Plastic connector for  
cable buncher ROHRflex-Multi

03.44



**RQ G2-M|P|N|U**  
Kunststoffverschraubung  
Plastic connector

03.19



**Multi-WFP**  
Kunststoff-Flansch Winkel 90°  
für Kunststoffsammler ROHRflex-Multi  
Plastic connector elbow 90°  
for cable buncher ROHRflex-Multi

03.45



**RQB90-M|P|N**

Kunststoffverschraubung, Bogen 90°  
Plastic connector, bend 90°



03.27

**RQBK90-M|P|N**

Kunststoffverschraubung, Bogen 90°  
mit Messinggewinde  
Plastic connector, bend 90°  
with brass thread



03.28

**RQBK90DR-M|P|N**

Kunststoffverschraubung  
Bogen 90° mit Messinggewinde  
drehbar  
Plastic connector  
bend 90°  
with turnable brass thread



03.29

**RQB1 90-M**

Kunststoffverschraubung  
Bogen 90°  
Plastic connector  
bend 90°



03.30

**RQLB1 90-M|P|N**

Kunststoffverschraubung  
Bogen 90°  
Plastic connector  
bend 90°



03.31

**RQB45-M|P|N**

Kunststoffverschraubung  
Bogen 45°  
Plastic connector  
bend 45°



03.32

**RQBK45-M|P**

Kunststoffverschraubung  
Bogen 45° mit Messinggewinde  
Plastic connector  
bend 45° with brass thread



03.33

**RQBK45DR-M**

Kunststoffverschraubung  
Bogen 45° mit Messinggewinde  
drehbar  
Plastic connector  
bend 45° with turnable brass thread



03.34

**RQB1 45-M|N**

Kunststoffverschraubung  
Bogen 45°  
Plastic connector  
bend 45°



03.35

**RQLB1 45-M|N**

Kunststoffverschraubung  
Bogen 45°  
Plastic connector  
bend 45°



03.36

**RQW-M|P|C|N**

Kunststoffverschraubung  
Winkel 90°  
Plastic connector  
elbow 90°



03.37

**RQW1-M|P|N**

Kunststoffverschraubung  
Winkel 90°  
Plastic connector  
elbow 90°



03.38

**RQW-F**

Kunststoffverschraubung  
Winkel 90°  
mit Flanschanschluss  
Plastic connector  
elbow 90° with flange



03.39

**RQF2-M**

Kunststoff-Flansch  
Plastic flange

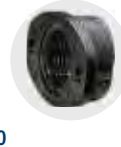

03.40

**RQE**

Endtülle  
Schlauch-Kabel  
Material TPE  
End cap  
from tubing to cable  
Material TPE



03.41

**RQA**

Endtülle  
Material PA  
End cap  
Material PA



03.42

**RQPRO**

Scheuerschutz  
Material PA  
Tubing abrasion protection  
Material PA



03.43

**RQT | RQT-PA**

Kunststoff-T-Verteiler  
Plastic T distributor



03.46

**RQY | RQY-PA**

Kunststoff-Y-Verteiler  
Plastic Y distributor



03.47

**RQK | RQK-PA**

Kunststoff-Kupplung  
Plastic coupler



03.48

**RQK-GW-PA**

Reparaturmuffe  
Repair sleeve



03.49

**RQGR**

Kunststoff-Reduzierung  
Plastic reducer



03.50

**RQH | RQHG**

Schlauchhalter  
Material PA  
Tubing clamp  
Material PA



03.51

**RQS**

Schlauchhalter einteilig  
Material PA  
Tubing clamp, one-part  
Material PA



03.52

**RQM | RQMS**

Massiver Schlauchhalter  
Material PA  
Heavy tubing clamp  
Material PA



03.53

**RQMR [-Kabel]**

Reduzierung für RQM  
Material TPE  
Reducer for clamp RQM  
Material TPE



03.54

**RQMR-MOVE**

Bewegliche Reduzierung für  
Schlauchhalter RQM  
Material PA  
Moveable reducer for clamp RQM  
Material PA



03.56

## VERSCHRAUBUNGSMONTAGE CONNECTOR ASSEMBLY



Einfach aufstecken

Just press in

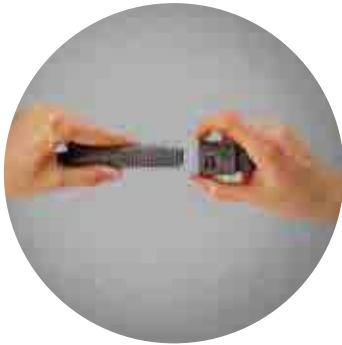

Ohne Werkzeug schnell demontiert

Quick dismantling without tools



Bund der Rasthülse an den Grundkörper andrücken und abziehen

Press ring on the housing and pull off

## SCHUTZART

Zum Erreichen der Schutzarten IP 68 | 67 | 66 | 65 nach EN 60529/ IEC 60529 und IP 69K\* nach DIN 40050 T.9 bitte folgendes beachten:  
Schutzschlauchtrennung:  
Wellschlauch ROHRflex® im Wellental trennen. Bitte darauf achten, dass eine Unplanheit von maximal einem Wellengang nicht überschritten wird.

## MONTAGE

Die Verschraubung mit Schlauchanschlussaufnahme auf die getrennte Schlauchseite montieren. Die Verschraubung auf den Wellschlauch schieben, bis dieser nicht weiter einrastet und die Verschraubung nur noch mit Kraftaufwand zu drehen ist. Der entlastete Wellschlauch drückt die Krallen der Rasthülse in die Wellschlauchtäler. Hierdurch wird die Verschraubung einwandfrei verriegelt.

FLEXAquick® Verschraubung mit einer Demontagesperre.

Ein O-Ring wird über die Verschraubung gezogen und in die Spalte zwischen Verschraubungsgehäuse und Rasthülse gedrückt. Hierdurch wird die Verschraubung einwandfrei verriegelt. Die Verschraubung kann nun nicht mehr ohne Werkzeug demontiert werden.

## DEMONTAGE

Die Demontage des Wellschlauches erfolgt durch Andrücken des Bundes der Rasthülse an den Verschraubungskörper, danach den Schlauch aus der Verschraubung, oder die Verschraubung vom Wellschlauch ziehen.

Die Verschraubung ist wieder einsatzbereit

## PROTECTIVE SYSTEM

Please note the following in order to attain protective System IP 68 | 67 | 66 | 65 acc. to EN 60529/IEC 60529 and IP 69K\* according to DIN 40050 T.9:  
Parting of protective tubing:  
Cut the ROHRflex® tubing between two ribs. More than one rib should not be passed while cutting the tubing.

## ASSEMBLY

Tubing and connector must be assembled to the cut tubing side. Push the connector on to the tubing until it can not snap-in any more and the connector can only be turned with force. The relieved corrugated tubing pushes the claws of the snap-in-sleeve between the ribs, this means an exact closing of the connection.

FLEXAquick® connector with locking device.

Pull O-ring over connector housing and between connector housing and snap-in-sleeve, which means a perfect lock. Now dismantling without tools is not possible.

## DISMOUNTING

Press the ring of the snap-in-sleeve to the connector case, then pull the tubing out or the connector from the tubing.

The connector is ready for use again.

\* Typengeprüft durch VDE gemäß DIN 40050 T.9

\* Type-tested by VDE acc. to DIN 40050 T.9



VIDEO

FLEXAquick® SYSTEM  
FLEXAquick® SYSTEM

KONSTRUKTION

Verschraubungsgehäuse mit oder ohne Sechskantschlüsselfläche, integrierte Rasthülse mit Dichteinsatz IP 68 | IP 69K\* ohne Dichteinsatz > IP 65

MATERIAL

Kunststoffverschraubungen  
Kunststoff [PA]  
Dichtung TPE

Kunststoffverschraubungen mit Messinggewinde  
Gehäuse Kunststoff [PA]  
Gewinde MS 58 vernickelt  
Dichtung TPE

EIGENSCHAFTEN

- rationelle Schlauchmontage durch einteilige Verschraubung mit push-in-Verschluss
- werkzeuglose Demontage durch Verschieben der Rasthülse
- kleinstmögliche Außenmaße für minimalsten Verschraubungsabstand

VERWENDUNG

Zur fachgerechten Montage als schutzisolierte Verschraubung geeignet nach Anwendungsvorschriften EN 60204 im Maschinen- und Anlagenbau.

STRUCTURE

Connector case with or without hexagonal wrench surface, integrated snap-in sleeve with sealing IP 68 | IP 69K\* without sealing > IP 65

MATERIAL

Plastic connectors  
plastics [PA]  
sealing TPE

Plastic connectors with brass thread  
body plastics [PA]  
thread nickel-plated brass 58  
sealing TPE

PROPERTIES

- rational tubing assembly due to one-piece connector with push-in lock
- dismantling without tools by displacing the snap-in sleeve
- smallest outer dimensions to be used under confined conditions

APPLICATION

For expert assembly applicable as protective insulation connector according to EN 60204 application rules for machine and plant constructions.

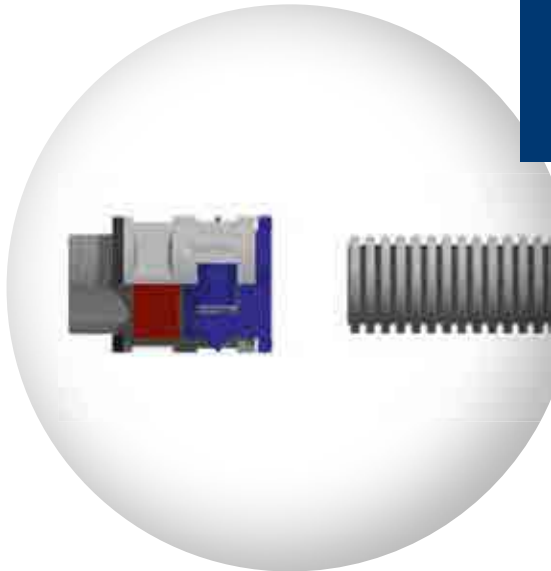

RQ-Grundkörper  
connector body RQ

Dichteinsatz  
sealing



Flachdichtung  
flat sealing

Rasthülse  
snap-in sleeve

IP 68 | IP 69K  
-40°C ... +120°C

EN / IEC 61386-23



UL 1696 | CSA 22.2  
UR file E86359



EN 45545-2 [HL 2]



ASTM E162 | E662  
SMP 800-C



VdW / GGVEB



# RQG

Kunststoff-Schnellverschraubung  
gerade  
Außengewinde  
hochdichtend

Plastic connector, quick-type  
straight  
outer thread  
high-density

## EIGENSCHAFTEN

- beständig gegen Öl und Benzin
- weitgehend säure- und lösungsmittelbeständig
- silikon-, cadmium- und halogenfrei

## PROPERTIES

- resistant against oil and benzene
- widely resistant to acids and solvents
- free of silicone, cadmium, halogen



VIDEO



FLEXA No.	FLEXA No.	AD OD								
schwarz black	grau grey	ø	mm	mm	mm	mm	mm	mm	kg 100	St. pcs.

RQG-M		Metr. EN 60423		[IP 68   69K]						
1 5020 037 210	1 5020 037 010	10,0	M 10 x 1,0	6,0	17,0	11,5	34,5	16	0,400	50
1 5020 065 203	1 5020 065 003	10,0	M 12 x 1,5	7,0	20,0	11,5	34,5	16	0,400	50
1 5020 037 212	1 5020 037 012	13,0	M 12 x 1,5	7,0	20,0	12,0	37,0	18	0,520	50
1 5020 065 205	1 5020 065 005	13,0	M 16 x 1,5	10,0	20,0	11,5	37,0	18	0,540	50
1 5020 037 216	1 5020 037 016	15,8	M 16 x 1,5	11,0	23,0	11,5	39,0	21	0,700	50
1 5020 065 207	1 5020 065 007	15,8	M 20 x 1,5	12,0	25,0	13,0	39,0	21	0,760	50
1 5020 037 218	1 5020 037 018	18,5	M 20 x 1,5	13,5	26,0	13,0	42,0	24	0,800	50
1 5020 037 220	1 5020 037 020	21,2	M 20 x 1,5	15,0	29,5	13,0	44,5	27	1,120	50
1 5020 065 209	1 5020 065 009	21,2	M 25 x 1,5	17,0	29,5	13,0	44,5	27	1,240	50
1 5020 037 225	1 5020 037 025	28,5	M 25 x 1,5	19,5	37,0	13,0	47,0	34	1,680	25
1 5020 065 211	1 5020 065 011	28,5	M 32 x 1,5	23,0	37,0	15,0	49,0	34	1,800	25
1 5020 037 232	1 5020 037 032	34,5	M 32 x 1,5	25,5	44,0	15,0	51,0	40	2,400	25
1 5020 037 238	1 5020 037 038	34,5	M 40 x 1,5	30,5	44,5	15,0	51,5	40	2,560	25
1 5020 037 240	1 5020 037 040	42,5	M 40 x 1,5	32,0	52,0	17,0	76,0	55	5,800	25
1 5020 037 245	1 5020 037 045	42,5	M 50 x 1,5	37,5	63,0	17,0	76,0	60	6,720	25
1 5020 037 250	1 5020 037 050	54,5	M 50 x 1,5	42,5	64,0	17,0	88,0	65	8,300	10
1 5020 037 263	1 5020 037 063	54,5	M 63 x 1,5	49,0	74,0	17,0	88,0	70	10,150	10

RQG-P		PG DIN 40430		[IP 68   69K]						
1 5020 026 207	1 5020 026 007	10,0	7	7,0	17,0	10,0	32,5	16	0,400	50
1 5020 027 202	1 5020 027 002	10,0	9	7,0	17,0	10,0	32,5	16	0,420	50
1 5020 027 203	1 5020 027 003	10,0	11	7,0	21,0	10,0	32,5	16	0,480	50
1 5020 027 205	1 5020 027 005	10,0	13,5	7,0	23,0	10,0	32,5	16	0,520	25
1 5020 027 201	1 5020 027 001	13,0	7	8,0	20,0	10,0	35,0	18	0,500	50
1 5020 026 209	1 5020 026 009	13,0	9	10,0	20,0	10,0	35,0	18	0,500	50
1 5020 027 204	1 5020 027 004	13,0	11	10,0	21,0	10,0	35,0	18	0,540	50
1 5020 027 206	1 5020 027 006	13,0	13,5	10,0	23,0	10,0	35,0	18	0,600	25
1 5020 026 211	1 5020 026 011	15,8	11	12,5	23,0	10,0	37,0	21	0,700	50
1 5020 027 207	1 5020 027 007	15,8	13,5	12,5	23,0	10,0	37,0	21	0,700	50
1 5020 027 210	1 5020 027 010	15,8	16	12,5	26,5	10,0	37,0	21	0,760	25
1 5020 026 213	1 5020 026 013	18,5	13,5	13,5	26,0	13,0	43,0	24	0,860	50
1 5020 026 214	1 5020 026 014	18,5	16	17,0	25,5	11,0	42,0	24	0,960	25
1 5020 027 209	1 5020 027 009	21,2	13,5	15,5	29,5	10,0	43,5	27	1,200	10
1 5020 026 216	1 5020 026 016	21,2	16	17,0	29,5	13,0	46,0	27	1,200	50
1 5020 027 208	1 5020 027 008	28,5	16	17,0	37,0	12,0	48,5	34	1,800	10
1 5020 026 221	1 5020 026 021	28,5	21	23,0	37,0	12,5	48,5	34	1,680	25
1 5020 026 229	1 5020 026 029	34,5	29	30,0	44,0	14,5	51,0	40	2,360	25
1 5020 026 236	1 5020 026 036	42,5	36	36,0	63,0	17,0	76,0	60	6,000	25
1 5020 026 248	1 5020 026 048	54,5	48	47,5	64,0	17,0	88,0	70	9,200	10

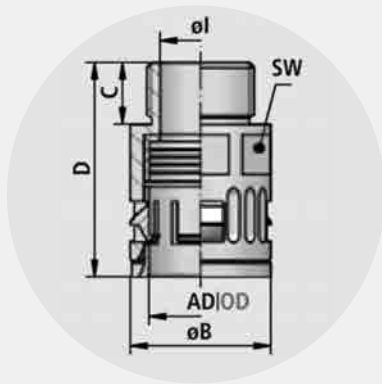

# RQG

Kunststoff-Schnellverschraubung  
gerade  
Außengewinde  
hochdichtend

Plastic connector, quick-type  
straight  
outer thread  
high-density

## EIGENSCHAFTEN

- beständig gegen Öl und Benzin
- weitgehend säure- und lösungsmittelbeständig
- silikon-, cadmium- und halogenfrei



## PROPERTIES

- resistant against oil and benzine
- widely resistant to acids and solvents
- free of silicone, cadmium, halogen

🔥 IP 68 | IP 69K  
🌡️ -40°C ... +120°C



EN / IEC 61386-23 



UL 1696 | CSA 22.2  
UR file E86359 

EN 45545-2 [HL 2]   

ASTM E162|E662  
SMP 800-C 

RQG-N  
CONDUIT FITTING 514D 









 /GGVSEB  



VIDEO



FLEXA No.	AD									
schwarz black	ø	ø		øl mm	øB mm	C mm	D mm	SW mm	kg 100	St. pcs.
<b>RQG-C</b>		CTG JIS B 0204	Whitworth DIN ISO 228-1							[IP 68 69K]
1 5020 052 212	13,0		1/4"	8,0	20,0	10,0	35,0	18	0,520	50
1 5020 052 209	13,0		3/8"	10,0	20,0	10,0	35,0	18	0,500	50
1 5020 052 201	13,0	G 16	1/2"	10,0	20,0	14,0	39,5	18	0,660	50
1 5020 052 210	15,8		3/8"	12,5	23,0	10,0	37,0	21	0,640	50
1 5020 052 202	15,8	G 16	1/2"	12,5	23,0	13,5	41,5	21	0,760	50
1 5020 052 203	21,2	G 16	1/2"	16,0	29,5	13,0	44,5	27	1,140	50
1 5020 052 204	28,5	G 22	3/4"	20,5	37,0	13,0	48,0	34	1,720	25
1 5020 052 205	34,5	G 28	1"	25,5	44,0	16,0	52,0	40	2,280	25
1 5020 052 206	42,5	G 36	1 1/4"	35,0	52,0	18,0	59,0	60	3,080	25
1 5020 052 211	54,5		1 1/2"	39,0	63,5	16,5	55,5	60	4,400	10
1 5020 052 207	54,5	G 54	2"	49,0	64,0	16,5	55,5	60	4,500	10
<b>RQG-N</b>		NPT ANSI/ASME B1.20.1								[IP 68 69K]
1 5020 056 201	10,0		1/4"	7,0	17,0	9,5	34,0	16	0,420	50
1 5020 056 202	13,0		1/4"	10,0	20,0	9,5	37,0	18	0,560	50
1 5020 056 203	13,0		3/8"	10,0	20,0	9,5	35,0	18	0,540	50
1 5020 056 204	15,8		3/8"	12,5	23,0	9,5	36,5	21	0,600	50
1 5020 056 205	15,8		1/2"	12,5	25,0	11,0	39,0	21	0,720	50
1 5020 056 206	21,2		1/2"	15,5	29,5	13,0	44,0	27	1,140	50
1 5020 038 221	28,5		3/4"	20,7	37,0	14,0	47,5	34	1,680	25
1 5020 038 227	34,5		1"	25,7	44,0	16,0	52,0	40	2,200	25
1 5020 056 207	42,5		1 1/4"	34,0	47,5	18,0	47,5	49	1,520	25
1 5020 056 208	42,5		1 1/2"	36,5	52,0	18,0	55,5	49	3,500	25
1 5020 056 209	54,5		1 1/2"	39,5	64,0	18,0	57,0	60	4,400	10
1 5020 056 210	54,5		2"	48,5	64,0	21,0	60,0	60	4,500	10

IP 68 | IP 69K  
-40°C ... +120°C

EN / IEC 61386-23



UL 1696 | CSA 22.2  
UR file E86359



EN 45545-2 [HL 3]



ASTM E162 | E662  
SMP 800-C



Gost | Lloyds Register



VIDEO

## RQ GK

Kunststoff-Schnellverschraubung  
gerade, Messingaußengewinde  
hochdichtend  
inkl. O-Ring [OR] oder Flachdichtring [FRH]

Plastic connector, quick-type  
straight, brass nickel-plated outer thread  
high-density  
incl. OR O-ring or FRH flat-sealing

### EIGENSCHAFTEN

- beständig gegen Öl und Benzin
- weitgehend säure- und lösungsmittelbeständig
- silikon-, cadmium- und halogenfrei
- hohe mechanische Belastbarkeit
- Schlagfestigkeit
- hohes Drehmoment des Gewindeanschlusses

### PROPERTIES

- resistant against oil and benzene
- widely resistant to acids and solvents
- free of silicone, cadmium, halogen
- fit for high mechanical stress
- impact-resistant
- high torque of thread connection

FLEXA No.

AD  
OD



schwarz  
black

ø

øl  
mm

øB  
mm

C  
mm

D  
mm

SW  
mm

kg|100

St.  
pcs.

### RQ GK – M

Metr.  
EN 60423

[IP 68 | 69K]

1 5107 010 212	10,0	M 12 x 1,5	7,0	20,0	10,0	38,5	18	1,080	50
1 5107 410 212*	10,0	M 12 x 1,5	7,0	20,0	5,0	33,5	18	0,800	50
1 5107 013 212	13,0	M 12 x 1,5	7,0	24,0	10,0	40,0	22	1,500	50
1 5107 413 212*	13,0	M 12 x 1,5	7,0	24,0	5,0	35,0	22	1,400	50
1 5107 013 216	13,0	M 16 x 1,5	8,5	24,0	12,0	42,0	22	1,660	50
1 5107 413 216*	13,0	M 16 x 1,5	8,5	24,0	5,0	35,0	22	1,550	50
1 5107 015 216	15,8	M 16 x 1,5	10,0	27,0	12,0	42,5	25	1,940	50
1 5107 415 216*	15,8	M 16 x 1,5	10,0	27,0	5,0	36,5	25	1,800	50
1 5107 015 220	15,8	M 20 x 1,5	11,0	27,0	12,0	43,5	25	2,020	50
1 5107 415 220*	15,8	M 20 x 1,5	11,0	27,0	6,0	37,5	25	1,695	50
1 5107 021 220	21,2	M 20 x 1,5	15,0	29,5	12,0	48,0	28	2,360	50
1 5107 421 220*	21,2	M 20 x 1,5	15,0	29,5	6,0	44,0	28	2,000	50
1 5107 021 225	21,2	M 25 x 1,5	16,0	33,0	13,0	49,0	31	3,240	25
1 5107 421 225*	21,2	M 25 x 1,5	16,0	33,0	7,0	44,0	31	2,300	25
1 5107 028 225	28,5	M 25 x 1,5	18,0	44,0	14,0	54,0	35	3,840	25
1 5107 428 225*	28,5	M 25 x 1,5	18,0	37,0	7,0	47,0	35	3,200	25
1 5107 028 232	28,5	M 32 x 1,5	20,0	41,0	14,0	54,0	39	5,080	25
1 5107 428 232*	28,5	M 32 x 1,5	20,0	41,0	8,0	48,0	39	4,000	25
1 5107 034 232	34,5	M 32 x 1,5	24,0	44,0	14,0	57,0	42	5,760	25
1 5107 434 232*	34,5	M 32 x 1,5	24,0	44,0	8,0	52,0	42	4,800	25
1 5107 034 240	34,5	M 40 x 1,5	27,5	48,0	17,0	64,0	46	6,000	25
1 5107 434 240*	34,5	M 40 x 1,5	27,5	48,0	8,0	55,0	46	5,400	25
1 5107 042 240	42,5	M 40 x 1,5	32,0	58,0	17,0	76,0	55	9,050	10
1 5107 442 240*	42,5	M 40 x 1,5	32,0	58,0	8,0	67,0	55	7,700	10
1 5107 042 250	42,5	M 50 x 1,5	37,5	63,0	17,0	76,0	60	14,500	10
1 5107 442 250*	42,5	M 50 x 1,5	37,5	63,0	9,0	68,0	60	13,700	10
1 5107 054 250	54,5	M 50 x 1,5	39,0	68,0	17,0	88,0	65	14,500	10
1 5107 454 250*	54,5	M 50 x 1,5	39,0	68,0	9,0	80,0	65	15,000	10
1 5107 054 263	54,5	M 63 x 1,5	49,0	74,0	17,0	88,0	70	23,000	10
1 5107 454 263*	54,5	M 63 x 1,5	49,0	74,0	10,0	81,0	70	22,700	10

### RQ GK – P

PG  
DIN 40430

[IP 68 | 69K]

1 5020 074 207	10,0	7	7,0	20,0	10,0	38,0	18	0,980	50
1 5020 074 209	13,0	9	8,5	24,0	12,0	42,0	22	1,580	50
1 5020 074 211	15,8	11	11,0	27,0	12,0	44,0	25	2,200	50
1 5020 074 213	18,5	13,5	12,5	29,0	12,0	47,5	26	2,300	50
1 5020 074 216	21,2	16	16,0	33,0	13,0	51,0	31	2,680	25
1 5020 074 221	28,5	21	20,0	41,0	14,0	55,0	39	5,000	25
1 5020 074 229	34,5	29	27,5	48,0	14,0	59,0	46	7,200	25
1 5020 074 236	42,5	36	36,0	63,0	17,0	76,0	60	13,100	10
1 5020 074 248	54,5	48	47,5	74,0	17,0	88,0	70	20,400	10

\* Lieferzeit auf Anfrage Delivery time on request



# RQG1

Kunststoff-Schnellverschraubung  
gerade, Außengewinde, konisch dichtend

Plastic connector, quick-type  
straight, outer thread, conically sealed

## EIGENSCHAFTEN

- beständig gegen Öl und Benzin
- weitgehend säure- und lösungsmittelbeständig
- silikon-, cadmium- und halogenfrei

## PROPERTIES

- resistant against oil and benzine
- widely resistant to acids and solvents
- free of silicone, cadmium, halogen

IP 66  
-40°C ... +120°C

EN / IEC 61386-23



UL 1696 | CSA 22.2  
UR file E86359



ASTM E162|E662  
SMP 800-C



Gost | Lloyds Register



FLEXA No.	FLEXA No.	AD OD								
schwarz black	grau grey	ø	øI mm	øB mm	C mm	D mm	SW mm	kg 100	St. pcs.	



VIDEO

### RQG1-M

Metr. EN 60423 [IP 66]

1 5020 055 210	1 5020 055 010	10,0	M 10 x 1,0	6,0	17,0	11,5	34,5	16	0,400	50
1 5020 055 211	1 5020 055 011	10,0	M 12 x 1,5	7,0	17,0	11,5	34,5	16	0,400	50
1 5020 055 212	1 5020 055 012	13,0	M 12 x 1,5	7,0	20,0	12,0	37,0	18	0,520	50
1 5020 055 214	1 5020 055 014	13,0	M 16 x 1,5	10,0	20,0	11,5	37,0	18	0,560	50
1 5020 055 216	1 5020 055 016	15,8	M 16 x 1,5	11,0	23,0	11,5	39,0	21	0,700	50
1 5020 055 218	1 5020 055 018	15,8	M 20 x 1,5	12,0	25,0	13,0	39,0	21	0,760	50
1 5020 055 219	1 5020 055 019	18,5	M 20 x 1,5	13,5	26,0	13,0	43,0	24	0,880	50
1 5020 055 220	1 5020 055 020	21,2	M 20 x 1,5	16,0	29,5	13,0	44,5	27	1,160	50
1 5020 055 222	1 5020 055 022	21,2	M 25 x 1,5	17,0	29,5	13,0	44,5	27	1,240	50
1 5020 055 225	1 5020 055 025	28,5	M 25 x 1,5	19,5	37,0	13,0	47,0	34	1,750	25
1 5020 055 228	1 5020 055 028	28,5	M 32 x 1,5	23,0	37,0	15,0	49,0	34	1,800	25
1 5020 055 232	1 5020 055 032	34,5	M 32 x 1,5	25,5	44,0	15,0	51,0	40	2,400	25
1 5020 055 236	1 5020 055 036	34,5	M 40 x 1,5	30,5	48,5	15,0	51,5	40	2,560	25
1 5020 055 240	1 5020 055 040	42,5	M 40 x 1,5	32,0	52,0	15,0	53,5	48	3,360	25
1 5020 055 245	1 5020 055 045	42,5	M 50 x 1,5	36,5	56,0	15,5	55,0	48	3,700	10
1 5020 055 250	1 5020 055 050	54,5	M 50 x 1,5	42,5	63,5	15,5	55,0	59	4,200	10
1 5020 055 263	1 5020 055 063	54,5	M 63 x 1,5	48,0	70,0	16,0	55,0	59	5,250	10

Kleine Packungseinheit small packing unit

1 5020 755 211		10,0	M 12 x 1,5	7,0	17,0	11,5	34,5	16	0,400	10
1 5020 755 214		13,0	M 16 x 1,5	10,0	20,0	11,5	37,0	18	0,560	10
1 5020 755 218		15,8	M 20 x 1,5	12,0	25,0	13,0	39,0	21	0,760	10
1 5020 755 222		21,2	M 25 x 1,5	17,0	29,5	13,0	44,5	27	1,240	10
1 5020 755 228		28,5	M 32 x 1,5	23,0	37,0	15,0	49,0	34	1,800	10
1 5020 755 236		34,5	M 40 x 1,5	30,5	48,5	15,0	51,5	40	2,560	2
1 5020 755 245		42,5	M 50 x 1,5	36,5	56,0	15,5	55,0	48	3,700	2
1 5020 755 263		54,5	M 63 x 1,5	48,0	70,0	16,0	55,0	59	5,250	2

### RQG1-P

PG DIN 40430 [IP 66]

1 5020 049 207	1 5020 049 007	10,0	7	7,0	17,0	10,0	32,5	16	0,420	50
1 5020 063 202		10,0	9	7,0	18,5	10,0	32,5	16	0,420	50
1 5020 063 203		10,0	11	7,0	21,0	10,0	32,5	16	0,480	50
1 5020 063 205		10,0	13,5	7,0	23,0	10,0	32,5	16	0,560	25
1 5020 062 201		13,0	7	8,0	20,0	10,0	35,0	18	0,520	50
1 5020 049 209	1 5020 049 009	13,0	9	10,0	20,0	10,0	35,0	18	0,520	50
1 5020 063 204		13,0	11	10,0	21,0	10,0	35,0	18	0,560	50
1 5020 063 206		13,0	13,5	10,0	23,0	10,0	35,0	18	0,600	25
1 5020 049 211	1 5020 049 011	15,8	11	12,5	23,0	10,0	37,0	21	0,700	50
1 5020 063 207		15,8	13,5	12,5	23,0	10,0	37,0	21	0,720	25
1 5020 063 210		15,8	16	12,5	26,5	10,0	37,0	21	0,800	25
1 5020 049 213	1 5020 049 013	18,5	13,5	13,5	26,0	13,0	43,0	24	0,880	50
1 5020 062 209		21,2	13,5	15,4	29,5	13,0	43,5	27	1,200	10
1 5020 049 216	1 5020 049 016	21,2	16	17,0	29,5	13,0	46,0	27	1,240	50
1 5020 062 208		28,5	16	17,0	37,0	12,0	48,5	34	1,800	10
1 5020 049 221	1 5020 049 021	28,5	21	23,0	37,0	13,0	48,5	34	1,680	25
1 5020 049 229	1 5020 049 029	34,5	29	30,0	44,0	14,5	53,5	40	2,400	25
1 5020 049 236	1 5020 049 036	42,5	36	36,5	52,0	14,5	56,0	48	3,120	25
1 5020 049 248	1 5020 049 048	54,5	48	48,0	65,5	15,5	58,0	59	4,400	10

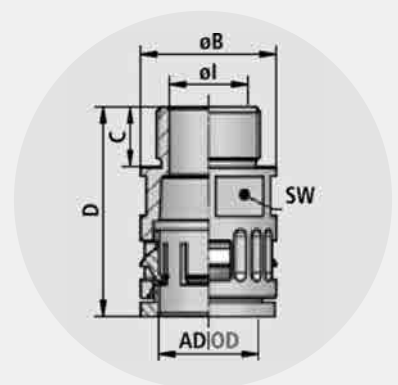

IP 66  
-40°C ... +120°C

EN / IEC 61386-23



UL 1696 | CSA 22.2  
UR file E86359



ASTM E162|E662  
SMP 800-C



RQG1-N  
CONDUIT FITTING 514D



Gost | Lloyds Register



VIDEO

# RQG1

Kunststoff-Schnellverschraubung  
gerade  
Außengewinde  
konisch dichtend

Plastic connector, quick-type  
straight  
outer thread  
conically sealed

## EIGENSCHAFTEN

- beständig gegen Öl und Benzin
- weitgehend säure- und lösungsmittelbeständig
- silikon-, cadmium- und halogenfrei

## PROPERTIES

- resistant against oil and benzene
- widely resistant to acids and solvents
- free of silicone, cadmium, halogens

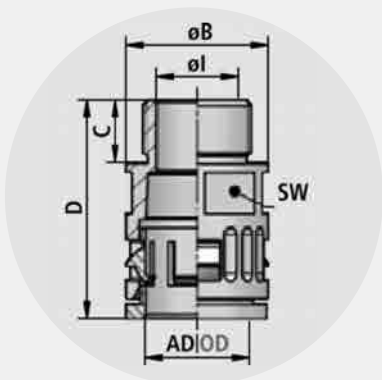

FLEXA No.	AD OD										
schwarz black	ø			øl mm	øB mm	C mm	D mm	SW mm	kg/100	St. pcs.	
<b>RQG1-C</b>		<b>CTG</b> JIS B 0204	<b>Whitworth</b> DIN ISO 228-1								[IP 66]
1 5020 058 208	10,0		1/4"	7,0	17,0	10,0	32,5	16	0,400	50	
1 5020 058 212	13,0		1/4"	9,0	20,0	10,0	35,0	18	0,520	50	
1 5020 058 209	13,0		3/8"	10,0	21,0	10,0	35,0	18	0,500	50	
1 5020 058 201	13,0	G 16	1/2"	13,0	27,0	14,0	39,5	18	0,660	50	
1 5020 058 210	15,8		3/8"	12,5	23,0	10,0	37,0	21	0,600	50	
1 5020 058 202	15,8	G 16	1/2"	12,5	27,0	13,5	41,5	21	0,780	50	
1 5020 058 203	21,2	G 16	1/2"	16,0	29,5	13,0	45,5	27	1,160	50	
1 5020 058 204	28,5	G 22	3/4"	20,5	37,0	13,0	48,0	34	1,720	25	
1 5020 058 205	34,5	G 28	1"	25,5	44,0	16,0	52,0	40	2,240	25	
1 5020 058 206	42,5	G 36	1 1/4"	35,0	52,0	18,0	56,5	49	2,800	25	
1 5020 058 211	54,5		1 1/2"	40,0	64,0	14,0	54,0	59	4,400	10	
1 5020 058 207	54,5	G 54	2"	49,0	64,0	18,0	58,0	60	4,500	10	
<b>RQG1-N</b>		<b>NPT</b> ANSI/ASME B1.20.1									[IP 66]
1 5020 046 205	15,8		1/2"	12,5	25,0	12,0	39,0	21	0,770	50	
1 5020 046 206	21,2		1/2"	15,5	29,5	12,0	43,5	27	1,000	50	
1 5020 046 214	28,5		3/4"	20,7	37,0	14,0	47,5	34	1,740	25	
1 5020 046 210	34,5		1"	25,7	44,0	14,0	52,0	40	2,200	25	
1 5020 046 217	42,5		1 1/4"	34,0	52,0	18,0	77,0	60	4,500	25	
1 5020 046 209	54,5		1 1/2"	39,5	64,0	18,0	89,0	70	4,650	10	

# RQLG1

Kunststoffverschraubung  
gerade, Außengewinde  
konisch dichtend

Plastic connector  
straight, outer thread  
conically sealed

IP 65  
-40°C ... +120°C

## MATERIAL

Kunststoff [PA modifiziert]

## MATERIAL

plastics [PA modified]

UL 1696 | CSA 22.2  
UR file E86359



ASTM E162|E662  
SMP 800-C



## EIGENSCHAFTEN

- beständig gegen Öl und Benzin
- weitgehend säure- und lösungsmittelbeständig
- silikon-, cadmium- und halogenfrei

## PROPERTIES

- resistant against oil and benzine
- widely resistant to acids and solvents
- free of silicone, cadmium, halogen

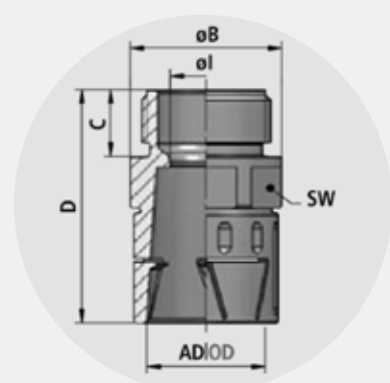

FLEXA No.	FLEXA No.	AD OD								
schwarz black	grau grey	ø		øI mm	øB mm	C mm	D mm	SW mm	kg 100	St. Pcs.
<b>RQLG1 – M</b>										
Metr. EN 60423 [IP 65]										
1 5115 010 212	1 5115 010 012	10,0	M 12 x 1,5	7,0	17,0	11,0	34,5	16	0,500	50
1 5115 013 216	1 5115 013 016	13,0	M 16 x 1,5	10,0	20,0	11,0	37,0	18	0,600	50
1 5115 015 220	1 5115 015 020	15,8	M 20 x 1,5	12,5	24,0	11,0	38,0	22	0,800	50
1 5115 018 220	1 5115 018 020	18,5	M 20 x 1,5	14,0	26,0	13,0	40,0	27	1,000	50
1 5115 018 225	1 5115 018 025	18,5	M 25 x 1,5	14,0	26,0	13,0	40,0	27	1,000	50
1 5115 021 220	1 5115 021 020	21,2	M 20 x 1,5	14,0	29,5	13,0	45,5	27	1,200	50
1 5115 021 225	1 5115 021 025	21,2	M 25 x 1,5	14,0	29,5	13,0	45,5	27	1,200	50
1 5115 028 225	1 5115 028 025	28,5	M 25 x 1,5	18,8	36,0	13,0	49,0	35	1,700	25
1 5115 028 232	1 5115 028 032	28,5	M 32 x 1,5	18,8	36,0	13,0	49,0	35	1,700	25
1 5115 034 232	1 5115 034 032	34,5	M 32 x 1,5	26,0	45,5	15,0	54,0	43	2,700	25
1 5115 034 240	1 5115 034 040	34,5	M 40 x 1,5	26,0	45,5	15,0	54,0	43	2,700	25
1 5115 042 240	1 5115 042 040	42,5	M 40 x 1,5	35,0	55,5	15,0	61,0	53	4,300	25
1 5115 042 250	1 5115 042 050	42,5	M 50 x 1,5	35,0	52,0	16,0	61,0	53	4,300	25
1 5115 054 250	1 5115 054 050	54,5	M 50 x 1,5	45,0	55,5	16,0	68,0	66	5,900	10
1 5115 054 263	1 5115 054 063	54,5	M 63 x 1,5	45,0	64,0	16,0	68,0	66	5,900	10
<b>RQLG1 – P</b>										
PG DIN 40430 [IP 65]										
1 5515 010 207		10,0	7	7,0	17,0	12,0	34,5	16	0,500	50
1 5515 013 209		13,0	9	10,0	20,0	12,0	37,0	18	0,600	50
1 5515 015 211		15,8	11	12,5	24,0	12,0	38,0	22	0,800	50
1 5515 018 213		18,5	13,5	14,0	26,0	13,0	40,0	27	1,000	50
1 5515 021 216		21,2	16	14,0	29,5	13,0	45,5	27	1,200	50
1 5515 028 221		28,5	21	18,8	36,0	15,0	49,0	35	1,700	25
1 5515 034 229		34,5	29	26,0	44,0	15,0	54,0	43	2,700	25
1 5515 042 236		42,5	36	35,0	52,0	16,0	61,0	53	4,300	25
1 5515 054 248		54,5	48	45,0	64,0	16,0	68,0	66	5,900	10
<b>RQLG1 – N</b>										
NPT ANSI/ASME B1.20.1 [IP 65]										
1 5715 015 205		15,8	1/2"	12,4	23,7	13,0	38,0	22	0,900	50
1 5715 021 205		21,2	1/2"	14,0	29,5	13,0	45,5	27	1,200	50
1 5715 028 214		28,5	3/4"	18,8	37,0	12,5	47,0	34	1,700	25
1 5715 034 210		34,5	1"	25,0	46,0	15,0	51,0	43	2,500	25

IP 68 | IP 69K  
-40°C ... +120°C

EN / IEC 61386-23

UL 1696 | CSA 22.2  
UR file E86359

EN 45545-2 [HL 3]

ASTM E162 | E662  
SMP 800-C



VIDEO

# RQGKZP

Kunststoff-Schnellverschraubung  
gerade  
Messingaußengewinde  
Zugentlastung  
hochdichtend  
inkl. O-Ring [OR]

Plastic connector, quick-type  
straight  
nickel-plated brass outer thread  
strain relief  
high-density  
incl. OR O-ring

## EIGENSCHAFTEN

- beständig gegen Öl und Benzin
- weitgehend säure- und lösungsmittelbeständig
- silikon-, cadmium- und halogenfrei
- hohe mechanische Belastbarkeit
- Schlagfestigkeit
- hohes Drehmoment des Gewindeanschlusses
- optimaler Halt bei gleichzeitiger Abdichtung der Kabel
- einteiliger Klemmeinsatz für isolationsschonende Fixierung

## PROPERTIES

- resistant against oil and benzene
- widely resistant to acids and solvents
- free of silicone, cadmium, halogen
- fit for high mechanical stress
- impact-resistant
- high torque of thread connection
- optimal held and sealing of cables at the same time
- one-piece terminal block for isolation gentle fixation

Um eine hohe Schutzart IP 68 | IP 69K am Gewinde zwischen Kabelverschraubungseinsatz und Verschraubungsgehäuse zu gewährleisten, ist eine Dichtungsmasse einzubringen. Bitte beachten Sie unsere Montageanleitung.

To ensure a high protection system, IP 68 | IP 69K, at the thread between cable gland insert and screw connector housing it is necessary to use a sealing compound. Please see our assembly instructions.

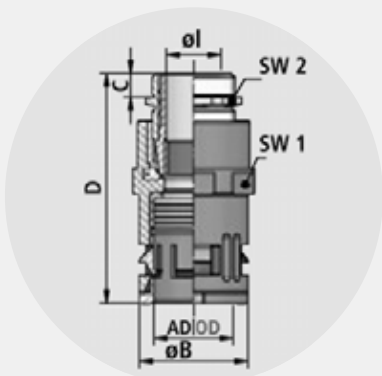

FLEXA No.



AD  
OD



schwarz  
black

mm

ø

øl  
mm

øB  
mm

C  
mm

D  
mm

SW1  
mm

SW2  
mm

kg|100

St.

pcs.

## RQGKZP-M

Metr.  
EN 60423

[IP 68 | 69K]

1 5112 013 216*		13,0	M 16 x 1,5	8,5	24,0	6,0	56,5	22	18	2,600	50
1 5112 113 216	4,0 - 6,0	13,0	M 16 x 1,5	8,5	24,0	6,0	56,5	22	18	2,600	50
1 5112 213 216	5,0 - 8,0	13,0	M 16 x 1,5	8,5	24,0	6,0	56,5	22	18	2,600	50
1 5112 313 216	6,5 - 9,5	13,0	M 16 x 1,5	8,5	24,0	6,0	56,5	22	18	2,600	50
1 5112 513 216*		13,0	M 16 x 1,5	8,5	24,0	15,0	65,5	22	18	2,750	50
1 5112 613 216	4,0 - 6,0	13,0	M 16 x 1,5	8,5	24,0	15,0	65,5	22	18	2,750	50
1 5112 713 216	5,0 - 8,0	13,0	M 16 x 1,5	8,5	24,0	15,0	65,5	22	18	2,750	50
1 5112 813 216	6,5 - 9,5	13,0	M 16 x 1,5	8,5	24,0	15,0	65,5	22	18	2,750	50
1 5112 015 220*		15,8	M 20 x 1,5	11,0	27,0	6,5	57,0	25	22	3,500	50
1 5112 115 220	4,0 - 6,0	15,8	M 20 x 1,5	11,0	27,0	6,5	57,0	25	22	3,500	50
1 5112 215 220	6,5 - 9,5	15,8	M 20 x 1,5	11,0	27,0	6,5	57,0	25	22	3,500	50
1 5112 315 220	7,0 - 10,5	15,8	M 20 x 1,5	11,0	27,0	6,5	57,0	25	22	3,500	50
1 5112 515 220*		15,8	M 20 x 1,5	11,0	27,0	15,0	65,5	25	22	3,650	50
1 5112 615 220	4,0 - 6,0	15,8	M 20 x 1,5	11,0	27,0	15,0	65,5	25	22	3,650	50
1 5112 715 220	6,5 - 9,5	15,8	M 20 x 1,5	11,0	27,0	15,0	65,5	25	22	3,650	50
1 5112 815 220	7,0 - 10,5	15,8	M 20 x 1,5	11,0	27,0	15,0	65,5	25	22	3,650	50
1 5112 021 220*		21,2	M 20 x 1,5	11,0	27,0	6,5	57,0	25	22	3,500	50
1 5112 121 220	6,5 - 9,5	21,2	M 20 x 1,5	11,0	27,0	6,5	57,0	25	22	3,500	50
1 5112 221 220	7,0 - 10,5	21,2	M 20 x 1,5	11,0	27,0	6,5	57,0	25	22	3,500	50
1 5112 321 220	9,0 - 13,0	21,2	M 20 x 1,5	11,0	27,0	6,5	57,0	25	22	3,500	50
1 5112 521 220*		21,2	M 20 x 1,5	11,0	27,0	15,0	65,5	25	22	3,650	50
1 5112 621 220	6,5 - 9,5	21,2	M 20 x 1,5	11,0	27,0	15,0	65,5	25	22	3,650	50
1 5112 721 220	7,0 - 10,5	21,2	M 20 x 1,5	11,0	27,0	15,0	65,5	25	22	3,650	50
1 5112 821 220	9,0 - 13,0	21,2	M 20 x 1,5	11,0	27,0	15,0	65,5	25	22	3,650	50











\* ohne Dichteinsatz without sealing insert

## RQ GKZP

🔥 IP 68 | IP 69K  
 🌡️ -40°C ... +120°C



VIDEO

FLEXA No.		AD OD									
schwarz black	mm	ø	øl	øB	C	D	SW1	SW2	kg 100	St.	
			mm	mm	mm	mm	mm	mm		pcs.	

RQ GKZP - M		Metr. EN 60423	[IP 68   69K]								
1 5112 021 225*		21,2	M 25 x 1,5	16,0	33,0	7,5	65,0	28	28	5,600	25
1 5112 121 225	9,0 - 13,0	21,2	M 25 x 1,5	16,0	33,0	7,5	65,0	28	28	5,600	25
1 5112 221 225	11,5 - 15,5	21,2	M 25 x 1,5	16,0	33,0	7,5	65,0	28	28	5,600	25
1 5112 521 225*		21,2	M 25 x 1,5	16,0	33,0	15,0	72,5	28	28	5,780	25
1 5112 621 225	9,0 - 13,0	21,2	M 25 x 1,5	16,0	33,0	15,0	72,5	28	28	5,780	25
1 5112 721 225	11,5 - 15,5	21,2	M 25 x 1,5	16,0	33,0	15,0	72,5	28	28	5,780	25
1 5112 028 225*		28,5	M 25 x 1,5	16,0	33,0	7,5	65,0	28	28	5,600	25
1 5112 128 225	9,0 - 13,0	28,5	M 25 x 1,5	16,0	33,0	7,5	65,0	28	28	5,600	25
1 5112 228 225	11,5 - 15,5	28,5	M 25 x 1,5	16,0	33,0	7,5	65,0	28	28	5,600	25
1 5112 528 225*		28,5	M 25 x 1,5	16,0	33,0	15,0	72,5	28	28	5,780	25
1 5112 628 225	9,0 - 13,0	28,5	M 25 x 1,5	16,0	33,0	15,0	72,5	28	28	5,780	25
1 5112 728 225	11,5 - 15,5	28,5	M 25 x 1,5	16,0	33,0	15,0	72,5	28	28	5,780	25
1 5112 028 232*		28,5	M 32 x 1,5	20,0	41,0	8,0	71,0	31	35	8,500	25
1 5112 128 232	14,0 - 18,0	28,5	M 32 x 1,5	20,0	41,0	8,0	71,0	31	35	8,500	25
1 5112 228 232	18,6 - 20,5	28,5	M 32 x 1,5	20,0	41,0	8,0	71,0	31	35	8,500	25
1 5112 528 232*		28,5	M 32 x 1,5	20,0	41,0	15,0	78,0	31	35	8,650	25
1 5112 628 232	14,0 - 18,0	28,5	M 32 x 1,5	20,0	41,0	15,0	78,0	31	35	8,650	25
1 5112 728 232	18,6 - 20,5	28,5	M 32 x 1,5	20,0	41,0	15,0	78,0	31	35	8,650	25
1 5112 034 240*		34,5	M 40 x 1,5	27,5	48,0	8,0	75,0	42	43	13,400	25
1 5112 134 240	20,0 - 25,0	34,5	M 40 x 1,5	27,5	48,0	8,0	75,0	42	43	13,400	25
1 5112 234 240	24,0 - 28,5	34,5	M 40 x 1,5	27,5	48,0	8,0	75,0	42	43	13,400	25
1 5112 534 240*		34,5	M 40 x 1,5	27,5	48,0	15,0	82,0	42	43	13,550	25
1 5112 634 240	20,0 - 25,0	34,5	M 40 x 1,5	27,5	48,0	15,0	82,0	42	43	13,550	25
1 5112 734 240	24,0 - 28,0	34,5	M 40 x 1,5	27,5	48,0	15,0	82,0	42	43	13,550	25
1 5112 042 250*		42,5	M 50 x 1,5	36,0	60,0	10,0	82,0	50	57	17,800	10
1 5112 142 250	27,0 - 32,0	42,5	M 50 x 1,5	36,0	60,0	10,0	82,0	50	57	17,800	10
1 5112 242 250	32,0 - 36,0	42,5	M 50 x 1,5	36,0	60,0	10,0	82,0	50	57	17,800	10
1 5112 542 250*		42,5	M 50 x 1,5	36,0	60,0	15,0	87,0	50	57	18,000	10
1 5112 642 250	27,0 - 32,0	42,5	M 50 x 1,5	36,0	60,0	15,0	87,0	50	57	18,000	10
1 5112 742 250	32,0 - 36,0	42,5	M 50 x 1,5	36,0	60,0	15,0	87,0	50	57	18,000	10
1 5112 054 250*		54,5	M 50 x 1,5	36,0	60,0	10,0	82,0	50	57	17,800	10
1 5112 154 250	32,0 - 36,0	54,5	M 50 x 1,5	36,0	60,0	10,0	82,0	50	57	17,800	10
1 5112 254 250	36,0 - 40,0	54,5	M 50 x 1,5	36,0	60,0	10,0	82,0	50	57	17,800	10
1 5112 554 250*		54,5	M 50 x 1,5	36,0	60,0	15,0	87,0	50	57	18,000	10
1 5112 654 250	32,0 - 36,0	54,5	M 50 x 1,5	36,0	60,0	15,0	87,0	50	57	18,000	10
1 5112 754 250	36,0 - 40,0	54,5	M 50 x 1,5	36,0	60,0	15,0	87,0	50	57	18,000	10
1 5112 054 263*		54,5	M 63 x 1,5	47,5	72,0	10,0	90,0	61	68	28,400	10
1 5112 154 263	36,0 - 40,0	54,5	M 63 x 1,5	47,5	72,0	10,0	90,0	61	68	28,400	10
1 5112 254 263	40,0 - 44,0	54,5	M 63 x 1,5	47,5	72,0	10,0	90,0	61	68	28,400	10
1 5112 554 263*		54,5	M 63 x 1,5	47,5	72,0	15,0	95,0	61	68	28,650	10
1 5112 654 263	36,0 - 40,0	54,5	M 63 x 1,5	47,5	72,0	15,0	95,0	61	68	28,650	10
1 5112 754 263	40,0 - 44,0	54,5	M 63 x 1,5	47,5	72,0	15,0	95,0	61	68	28,650	10

\* ohne Dichteinsatz without sealing insert

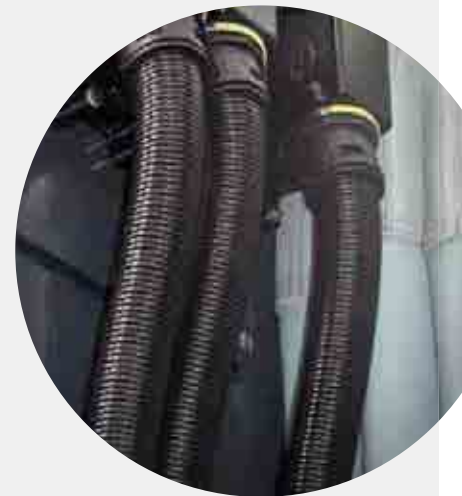

IP 68 | IP 69K  
-40°C ... +120°C

EN / IEC 61386-23

UL 1696 | CSA 22.2  
UR file E86359

EN 45545-2 [HL 3]

ASTM E162 | E662  
SMP 800-C

UV REACH RoHS



VIDEO

# RQGKZ

Kunststoff-Schnellverschraubung  
gerade  
Messingaußengewinde  
Zugentlastung  
hochdichtend  
inkl. O-Ring [OR]

Plastic connector, quick-type  
straight  
nickel-plated brass outer thread  
strain relief  
high-density  
incl. OR O-ring

## EIGENSCHAFTEN

- beständig gegen Öl und Benzin
- weitgehend säure- und lösungsmittelbeständig
- silikon-, cadmium- und halogenfrei
- hohe mechanische Belastbarkeit
- Schlagfestigkeit
- hohes Drehmoment des Gewindeanschlusses
- optimaler Halt bei gleichzeitiger Abdichtung der Kabel

## PROPERTIES

- resistant against oil and benzene
- widely resistant to acids and solvents
- free of silicone, cadmium, halogen
- fit for high mechanical stress
- impact-resistant
- high torque of thread connection
- optimal held and sealing of cables at the same time

Um eine hohe Schutzart IP 68 | IP 69K am Gewinde zwischen Kabelverschraubungseinsatz und Verschraubungsgehäuse zu gewährleisten, ist eine Dichtungsmasse einzubringen. Bitte beachten Sie unsere Montageanleitung.

To ensure a high protection system, IP 68 | IP 69K, at the thread between cable gland insert and screw connector housing it is necessary to use a sealing compound. Please see our assembly instructions.

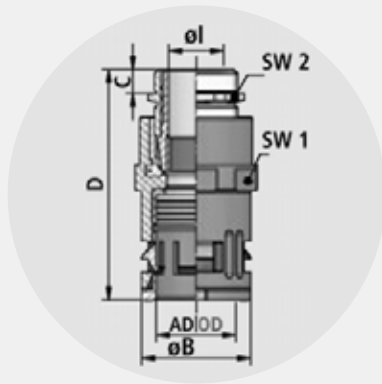

FLEXA No.



AD  
OD



schwarz  
black

mm

ø

mm

mm

mm

mm

mm

mm

kg|100

St.  
pcs.

## RQGKZ – M

Metr.  
EN 60423

[IP 68 | 69K]

1 5110 010 212	3,0 - 5,3	10,0	M 12 x 1,5	6,5	20,0	5,0	51,0	18	14	2,200	50
1 5110 013 216	5,0 - 8,5	13,0	M 16 x 1,5	8,5	24,0	5,0	55,0	22	17	3,330	50
1 5110 015 220	7,5 - 10,0	15,8	M 20 x 1,5	11,0	27,0	6,0	61,0	25	22	4,920	50
1 5110 021 220	10,0 - 12,5	21,2	M 20 x 1,5	12,5	33,0	6,0	64,0	30	22	6,470	25
1 5110 021 225	9,0 - 16,0	21,2	M 25 x 1,5	15,5	33,0	7,0	69,0	31	27	6,780	25
1 5110 028 225	11,0 - 16,0	28,5	M 25 x 1,5	16,0	42,8	7,0	71,0	41	27	6,720	25
1 5110 028 232	12,0 - 16,0	28,5	M 32 x 1,5	20,0	42,8	8,0	73,0	41	34	10,120	25
1 5110 034 232	14,5 - 20,5	34,5	M 32 x 1,5	21,0	48,0	8,0	79,0	46	34	11,200	25
1 5110 034 240	19,0 - 20,5	34,5	M 40 x 1,5	27,0	48,0	8,0	79,0	46	43	15,830	25
1 5110 042 240	21,0 - 26,0	42,5	M 40 x 1,5	27,0	57,3	8,0	106,0	55	43	18,960	10
1 5110 042 250	25,0 - 35,0	42,5	M 50 x 1,5	35,5	60,0	9,0	110,0	55	55	28,880	10
1 5110 054 250	25,0 - 35,0	54,5	M 50 x 1,5	35,5	68,0	9,0	122,0	65	55	31,470	10
1 5110 054 263	32,0 - 41,5	54,5	M 63 x 1,5	41,5	73,0	10,0	124,0	65	65	39,460	10

## RQGKZ – P

PG  
DIN 40430

[IP 68 | 69K]

1 5500 010 207	3,0 - 6,0	10,0	7	6,8	20,5	5,0	50,0	18	14	1,750	50
1 5500 013 209	3,0 - 8,0	13,0	9	8,5	24,0	6,0	56,5	22	17	2,600	50
1 5500 015 211	5,0 - 10,0	15,8	11	10,5	27,0	6,0	57,0	25	20	3,500	50
1 5500 021 216	11,0 - 14,0	21,2	16	14,8	33,0	6,5	65,0	31	24	5,120	25
1 5500 028 221	12,0 - 18,0	28,5	21	18,5	41,0	7,0	71,0	39	30	8,480	25
1 5500 034 229	19,0 - 25,0	34,5	29	25,5	48,5	8,0	75,0	46	40	13,280	25
1 5500 042 236	25,0 - 33,0	42,5	36	34,5	58,0	9,0	103,0	55	50	17,800	10
1 5500 054 248	35,0 - 43,0	54,5	48	44,0	68,0	10,0	120,0	65	64	33,900	10

# RQ GKZE

Kunststoff-Schnellverschraubung gerade  
Messingaußengewinde  
Zugentlastung und Schirmauflage  
hochdichtend  
inkl. O-Ring [OR]

Plastic connector, quick-type straight  
nickel-plated brass outer thread  
strain relief and shielding  
high-density  
incl. OR O-ring



IP 68 | IP 69K  
-40°C ... +120°C

## EIGENSCHAFTEN

- beständig gegen Öl und Benzin
- weitgehend säure- und lösungsmittelbeständig
- silikon-, cadmium- und halogenfrei
- hohe mechanische Belastbarkeit
- Schlagfestigkeit
- hohes Drehmoment des Gewindeanschlusses
- optimaler Halt bei gleichzeitiger Abdichtung der Kabel

Um eine hohe Schutzart IP 68 | IP 69K am Gewinde zwischen Kabelverschraubungseinsatz und Verschraubungsgehäuse zu gewährleisten, ist eine Dichtungsmasse einzubringen. Bitte beachten Sie unsere Montageanleitung.

## PROPERTIES

- resistant against oil and benzine
- widely resistant to acids and solvents
- free of silicone, cadmium, halogen
- fit for high mechanical stress
- impact-resistant
- high torque of thread connection
- optimal held and sealing of cables at the same time

To ensure a high protection system, IP 68 | IP 69K, at the thread between cable gland insert and screw connector housing it is necessary to use a sealing compound. Please see our assembly instructions.

EN / IEC 61386-23

UL 1696 | CSA 22.2  
UR file E86359

EN 45545-2 [HL 3]

ASTM E162 | E662  
SMP 800-C



VIDEO

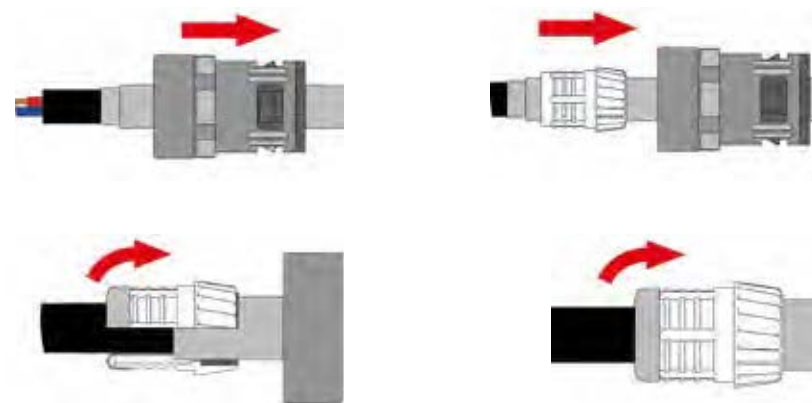
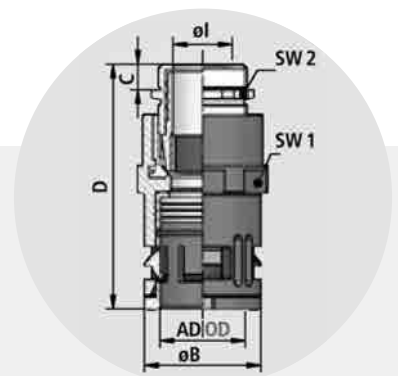

FLEXA No.		AD OD											
schwarz black	mm	ø	øl mm	øB mm	C mm	D mm	SW1 mm	SW2 mm	kg 100	St. pcs.			

RQ GKZE – M	Metr. EN 60423											[IP 68   69K]	
1 5111 013 216*	5,0- 8,5	13,0	M 16 x 1,5	8,5	24,0	5,0	55,0	22	17	3,440	50		
1 5111 015 220*	7,5-10,0	15,8	M 20 x 1,5	11,0	27,0	6,0	61,0	25	22	3,500	50		
1 5111 021 220*	10,0-12,5	21,2	M 20 x 1,5	12,5	33,0	6,0	64,0	30	22	6,470	25		
1 5111 021 225*	9,0-16,0	21,2	M 25 x 1,5	15,5	33,0	7,0	69,0	31	27	6,780	25		
1 5111 028 225*	11,0-16,0	28,5	M 25 x 1,5	16,0	42,8	7,0	71,0	41	27	6,720	25		
1 5111 034 232*	14,5-20,5	34,5	M 32 x 1,5	21,0	48,0	8,0	79,0	46	34	11,200	25		
1 5111 042 240*	20,0-26,5	42,5	M 40 x 1,5	27,0	57,5	8,0	106,0	55	43	18,960	10		
1 5111 054 250*	25,0-35,0	54,5	M 50 x 1,5	35,5	68,0	9,0	122,0	65	55	31,470	10		
1 5111 054 263*	32,0-41,5	54,5	M 63 x 1,5	41,5	73,0	10,0	124,0	65	65	39,460	10		

\* Lieferzeit auf Anfrage Delivery time on request



IP 68|IP 69K  
-40°C ... +120°C

EN / IEC 61386-23

EN 45545-2 [HL 3]

ASTM E162|E662  
SMP 800-C



VIDEO

## RQGKZED

Kunststoff-Schnellverschraubung  
gerade  
Messingaußengewinde  
Zugentlastung, Schirmauflage  
und Federkontaktierung  
hochdichtend  
inkl. O-Ring [OR]

Plastic connector, quick-type  
straight  
nickel-plated brass outer thread  
strain relief, shielding and  
contacting spring  
high-density  
incl. OR O-ring

### EIGENSCHAFTEN

- schnelle und einfache EMV-Verbindung des Schirmflechts über die Kontaktfeder
- selbstverlöschend
- beständig gegen Öl und Benzin
- weitgehend säure- und lösungsmittelbeständig
- silikon-, cadmium- und halogenfrei
- hohe mechanische Belastbarkeit
- Schlagfestigkeit
- hohes Drehmoment des Gewindeanschlusses
- optimaler Halt bei gleichzeitiger Abdichtung der Kabel

### PROPERTIES

- quick and easy EMC connection of the cable shield via the contacting spring
- self-extinguishing
- resistant against oil and benzine
- widely resistant to acids and solvents
- free of silicone, cadmium, halogen
- fit for high mechanical stress
- impact-resistant
- high torque of thread connection
- optimal held and sealing of cables at the same time

Um eine hohe Schutzart IP 68|IP 69K am Gewinde zwischen Kabelverschraubungseinsatz und Verschraubungsgehäuse zu gewährleisten, ist eine Dichtungsmasse einzubringen. Bitte beachten Sie unsere Montageanleitung.

To ensure a high protection system, IP 68|IP 69K, at the thread between cable gland insert and screw connector housing it is necessary to use a sealing compound. Please see our assembly instructions.

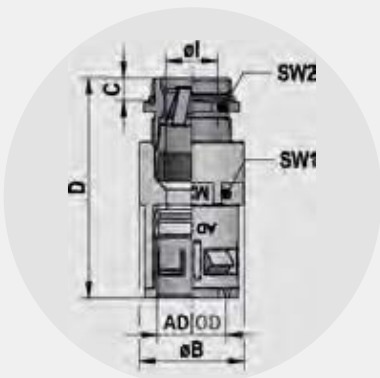

FLEXA No.



AD  
OD



schwarz  
black

mm

EMV|EMC  
mm

ø

mm

mm

mm

mm

mm

mm

kg|100

St.

pcs.

### RQGKZED-M

Metr.  
EN 60423

[IP 68|69K]

FLEXA No.	5,0- 8,5	2,0- 8,0	AD	ø	ø1	øB	C	D	SW1	SW2	kg 100	St.	
1 5133 013 216*	5,0- 8,5	2,0- 8,0	13,0		M 16 x 1,5	8,5	24,0	5,0	55,0	22	17	3,570	20
1 5133 015 220*	7,5- 10,0	3,0- 10,0	15,8		M 20 x 1,5	11,0	27,0	6,0	61,0	25	22	5,290	20
1 5133 021 220*	10,0- 12,5	3,0- 11,0	21,2		M 20 x 1,5	12,5	33,0	6,0	64,0	30	22	6,830	10
1 5133 021 225*	9,0- 16,0	8,0- 14,0	21,2		M 25 x 1,5	15,5	33,0	7,0	69,0	31	27	7,780	10
1 5133 028 225*	11,0- 16,0	8,0- 14,0	28,5		M 25 x 1,5	16,0	42,8	7,0	71,0	41	27	8,640	10
1 5133 028 232*	12,0- 20,0	10,0- 19,0	28,5		M 32 x 1,5	20,0	42,8	8,0	73,0	41	34	12,670	10
1 5133 034 232*	14,5- 20,5	10,0- 19,0	34,5		M 32 x 1,5	21,0	48,0	8,0	79,0	46	34	13,650	10
1 5133 034 240*	19,0- 26,0	15,0- 25,0	34,5		M 40 x 1,5	27,0	48,0	8,0	79,0	46	43	19,890	10
1 5133 042 240*	21,0- 26,0	15,0- 25,0	42,5		M 40 x 1,5	27,0	57,3	8,0	106,0	55	43	22,990	10
1 5133 042 250*	25,0- 35,0	22,0- 33,0	42,5		M 50 x 1,5	35,5	60,0	9,0	110,0	55	55	33,750	10
1 5133 054 250*	25,0- 35,0	22,0- 33,0	54,5		M 50 x 1,5	35,5	68,0	9,0	122,0	65	55	36,320	10
1 5133 054 263*	32,0- 41,5	31,0- 40,0	54,5		M 63 x 1,5	41,5	73,0	10,0	124,0	65	65	47,700	10

\* Lieferzeit auf Anfrage Delivery time on request



# RQGZ

Kunststoff-Schnellverschraubung  
gerade  
Außengewinde  
Zugentlastung  
hochdichtend

Plastic connector, quick-type  
straight  
outer thread  
strain relief  
high-density

🔥 IP 68 | IP 69K  
🌡️ -40°C ... +120°C

## EIGENSCHAFTEN

- beständig gegen Öl und Benzin
- weitgehend säure- und lösungsmittelbeständig
- silikon-, cadmium- und halogenfrei
- optimaler Halt bei gleichzeitiger Abdichtung der Kabel

Um eine hohe Schutzart IP 68 | IP 69K am Gewinde zwischen Kabelverschraubungseinsatz und Verschraubungsgehäuse zu gewährleisten, ist eine Dichtungsmasse einzubringen. Bitte beachten Sie unsere Montageanleitung.



## PROPERTIES

- resistant against oil and benzine
- widely resistant to acids and solvents
- free of silicone, cadmium, halogen
- optimal held and sealing of cables at the same time





To ensure a high protection system, IP 68 | IP 69K, at the thread between cable gland insert and screw connector housing it is necessary to use a sealing compound. Please see our assembly instructions.

EN / IEC 61386-23 

UL 1696 | CSA 22.2  
UR file E86359 

EN 45545-2 [HL 2]   









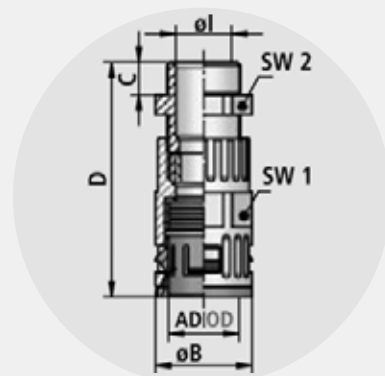









ASTM E162 | E662  
SMP 800-C 



VIDEO



FLEXA No.	FLEXA No.		AD OD																	
schwarz black	grau grey	mm	ø	øl mm	øB mm	C mm	D mm	SW1 mm	SW2 mm	kg/100	St. pcs.									

### RQGZ-M

Metr. EN 60423 [IP 68 | 69K]

1 5020 031 212	1 5020 031 012	4,0 - 6,5	10,0	M 12 x 1,5	6,5	17,0	8,0	51,0	16	15	0,800	20
1 5020 031 216	1 5020 031 016	5,0 - 9,5	13,0	M 16 x 1,5	9,5	20,0	8,0	53,0	18	20	1,300	20
1 5020 031 217	1 5020 031 017*	5,0 - 9,5	15,8	M 16 x 1,5	10,5	23,0	8,0	60,0	21	20	1,500	20
1 5020 031 220	1 5020 031 020	8,0 - 11,0	15,8	M 20 x 1,5	12,0	23,0	8,0	59,0	21	24	1,500	20
1 5020 031 223	1 5020 031 023*	8,0 - 11,0	18,5	M 20 x 1,5	12,0	27,0	8,0	59,0	24	24	1,700	20
1 5020 031 222	1 5020 031 022	8,0 - 11,0	21,2	M 20 x 1,5	12,0	29,5	8,0	68,0	27	24	1,800	10
1 5020 031 225	1 5020 031 025	11,0 - 16,0	21,2	M 25 x 1,5	16,0	33,5	8,0	70,0	27	29	3,000	10
1 5020 031 228	1 5020 031 028	11,0 - 16,0	28,5	M 25 x 1,5	16,0	37,0	8,0	82,0	34	29	3,200	10
1 5020 031 232	1 5020 031 032	15,0 - 21,0	28,5	M 32 x 1,5	18,0	37,0	10,0	82,0	34	36	3,800	10
1 5020 031 240	1 5020 031 040	16,0 - 26,0	34,5	M 40 x 1,5	25,0	44,0	10,0	85,0	40	46	5,700	10
1 5020 031 250	1 5020 031 050	27,0 - 35,0	42,5	M 50 x 1,5	32,0	58,0	12,0	141,0	55	55	11,200	10
1 5020 031 263	1 5020 031 063	32,0 - 42,0	54,5	M 63 x 1,5	44,0	68,0	12,0	145,0	65	68	16,270	10

### RQGZ-P

PG DIN 40430 [IP 68 | 69K]

1 5020 034 207	1 5020 034 007	3,0 - 6,5	10,0	7	7,0	17,0	8,0	51,0	16	15	0,800	20
1 5020 034 209	1 5020 034 009	4,0 - 8,0	13,0	9	8,0	20,0	8,0	53,0	18	19	1,050	20
1 5020 034 211	1 5020 034 011	5,0 - 10,0	15,8	11	10,0	23,0	8,0	59,0	21	22	1,450	20
1 5020 034 213	1 5020 034 013	6,0 - 12,0	15,8	13,5	12,0	27,0	9,0	59,0	21	24	1,600	20
1 5020 034 214	1 5020 034 014	6,0 - 12,0	18,5	13,5	12,0	27,0	9,0	59,0	24	24	1,600	20
1 5020 034 215	1 5020 034 015	6,0 - 12,0	21,2	13,5	12,0	29,5	9,0	70,0	27	24	2,200	10
1 5020 034 216	1 5020 034 016	10,0 - 14,0	21,2	16	14,0	29,5	10,0	72,0	27	27	2,300	10
1 5020 034 221	1 5020 034 021	13,0 - 18,0	28,5	21	18,0	37,0	11,0	82,0	34	33	3,500	10
1 5020 034 229	1 5020 034 029	18,0 - 25,0	34,5	29	25,0	44,0	11,0	85,0	40	42	5,000	10
1 5020 034 236	1 5020 034 036	22,0 - 32,0	42,5	36	32,0	58,0	13,0	140,0	55	53	8,500	10
1 5020 034 248	1 5020 034 048	34,0 - 44,0	54,5	48	44,0	68,0	14,0	144,0	65	65	11,200	10

### RQGZ-N

NPT ANSI/ASME B1.20.1 [IP 68 | 69K]

1 5704 015 205*		6,0 - 12,0	15,8	1/2"	12,0	27,0	15,0	69,0	21	24	1,600	20
1 5704 021 205*		7,0 - 10,0	21,2	1/2"	12,0	29,5	15,0	73,0	27	24	2,200	10
1 5704 028 214*		12,0 - 18,0	28,5	3/4"	18,0	37,0	15,0	79,0	34	33	3,400	10
1 5704 034 210*		21,0 - 25,0	34,5	1"	25,0	44,0	18,0	89,0	40	42	5,000	10
1 5704 042 217*		24,0 - 32,0	42,5	1 1/4"	32,0	52,0	19,0	100,0	49	53	8,900	10

\* Lieferzeit auf Anfrage Delivery time on request

IP 66  
-40°C ... +120°C

EN / IEC 61386-23

UL 1696 | CSA 22.2  
UR file E86359

ASTM E162 | E662  
SMP 800-C



VIDEO

# RQGZ1

Kunststoff-Schnellverschraubung  
gerade  
Außengewinde  
Zugentlastung  
konisch dichtend

Plastic connector, quick-type  
straight  
outer thread  
strain relief  
conically sealed

## EIGENSCHAFTEN

- beständig gegen Öl und Benzin
- weitgehend säure- und lösungsmittelbeständig
- silikon-, cadmium- und halogenfrei
- optimaler Halt bei gleichzeitiger Abdichtung der Kabel

## PROPERTIES

- resistant against oil and benzene
- widely resistant to acids and solvents
- free of silicone, cadmium, halogen
- optimal held and sealing of cables at the same time

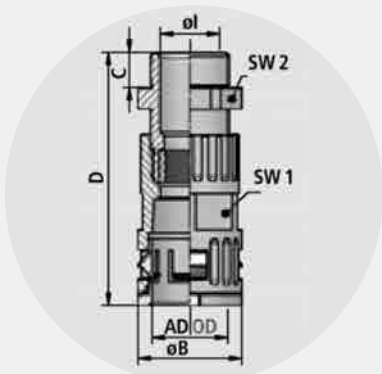

FLEXA No.	FLEXA No.		AD OD									
schwarz black	grau grey	mm	ø		øl mm	øB mm	C mm	D mm	SW1 mm	SW2 mm	kg/100	St. pcs.

RQGZ1 – M		Metr. EN 60423										[IP 66]
1 5109 010 212	1 5109 010 012	4,0- 6,5	10,0	M 12 x 1,5	6,5	17,0	8,0	51,0	16	15	0,800	20
1 5109 013 216	1 5109 013 016	5,0- 9,5	13,0	M 16 x 1,5	9,5	20,0	8,0	53,0	18	20	1,300	20
1 5109 015 220	1 5109 015 020	8,0-11,0	15,8	M 20 x 1,5	13,0	23,0	8,0	59,0	21	24	1,550	20
1 5109 021 225	1 5109 021 025	11,0-16,0	21,2	M 25 x 1,5	16,0	33,5	8,0	70,0	27	29	3,100	10
1 5109 028 225	1 5109 028 025	11,0-16,0	28,5	M 25 x 1,5	16,0	37,0	8,0	82,0	34	29	3,200	10
1 5109 028 232	1 5109 028 032	15,0-21,0	28,5	M 32 x 1,5	18,0	37,0	10,0	82,0	34	36	3,800	10
1 5109 034 240	1 5109 034 040	16,0-26,0	34,5	M 40 x 1,5	25,0	44,0	10,0	85,0	40	46	5,800	10
1 5109 042 250	1 5109 042 050	27,0-35,0	42,5	M 50 x 1,5	32,0	58,0	12,0	104,0	49	55	9,000	10
1 5109 054 263	1 5109 054 063	32,0-42,0	54,5	M 63 x 1,5	44,0	68,0	12,0	139,0	60	68	11,800	10

RQGZ1 – P		PG DIN 40430										[IP 66]
1 5020 060 207		3,0- 6,5	10,0	7	7,0	17,0	8,0	51,0	16	15	0,750	20
1 5020 060 209		4,0- 8,0	13,0	9	8,0	20,0	8,0	53,0	18	19	1,050	20
1 5020 060 211		5,0-10,0	15,8	11	10,0	23,0	8,0	59,0	21	22	1,450	20
1 5020 060 213		6,0-11,0	15,8	13,5	12,0	27,0	9,0	59,0	21	24	1,600	20
1 5020 060 215		6,0-12,0	21,2	13,5	12,0	29,5	9,0	70,0	27	24	2,300	10
1 5020 060 216		10,0-14,0	21,2	16	14,0	29,5	10,0	72,0	27	27	2,400	10
1 5020 060 221		13,0-18,0	28,5	21	18,0	37,0	11,0	82,0	34	33	3,400	10
1 5020 060 229		18,0-25,0	34,5	29	25,0	44,0	11,0	85,0	40	42	5,000	10
1 5020 060 236		22,0-32,0	42,5	36	32,0	52,0	13,0	106,0	49	53	8,500	10
1 5020 060 248		34,0-44,0	54,5	48	44,0	64,0	14,0	112,0	60	65	11,800	10

RQGZ1 – N		NPT ANSI/ASME B1.20.1										[IP 66]
1 5705 015 205		6,0-12,0	15,8	1/2"	12,0	27,0	15,0	69,0	21	24	1,600	20
1 5705 021 205		7,0-12,0	21,2	1/2"	12,0	29,5	15,0	73,0	27	24	2,200	10
1 5705 028 214		12,0-18,0	28,5	3/4"	18,0	37,0	15,0	79,0	34	33	3,400	10
1 5705 034 210		21,0-25,0	34,5	1"	25,0	44,0	18,0	89,0	40	42	5,000	10
1 5705 042 217		24,0-32,0	42,5	1 1/4"	32,0	52,0	18,0	100,0	49	53	8,900	10

# RQG2

Kunststoff-Schnellverschraubung  
gerade  
Innengewinde  
hochdichtend

Plastic connector, quick-type  
straight  
inner thread  
high-density











## EIGENSCHAFTEN

- beständig gegen Öl und Benzin
- weitgehend säure- und lösungsmittelbeständig
- silikon-, cadmium- und halogenfrei

## PROPERTIES

- resistant against oil and benzine
- widely resistant to acids and solvents
- free of silicone, cadmium, halogen









IP 68 | IP 69K  
-40°C ... +120°C

EN / IEC 61386-23   
 UL 1696 | CSA 22.2   
 UR file E86359  
 EN 45545-2 [HL 2]     
 ASTM E162|E662   
 SMP 800-C     



VIDEO



FLEXA No.	FLEXA No.	AD OD									
schwarz black	grau grey	ø	øI	øB	øB1	C	D	SW	kg 100	St. pcs.	

RQG2 – M		Metr. EN 60423		[IP 68   69K]							
1 5020 078 201	1 5020 078 001	10,0	M 12 x 1,5	7,5	17,0	17,0	9,5	36,5	16	0,450	50
1 5020 078 215	1 5020 078 015	13,0	M 12 x 1,5	10,0	20,0	23,0	9,5	34,5	18	0,550	50
1 5020 078 214	1 5020 078 014	13,0	M 16 x 1,5	10,0	20,0	21,0	9,5	36,5	18	0,640	50
1 5020 078 216	1 5020 078 016	15,8	M 16 x 1,5	12,5	23,0	21,0	9,5	39,0	21	0,760	50
1 5020 078 220	1 5020 078 020	21,2	M 20 x 1,5	16,5	29,5	24,0	12,5	49,0	27	1,260	50
1 5020 078 225	1 5020 078 025	28,5	M 25 x 1,5	17,0	37,0	30,0	13,5	54,0	34	2,000	25
1 5020 078 232	1 5020 078 032	34,5	M 32 x 1,5	24,0	44,0	35,0	15,0	55,5	40	2,200	10
1 5020 078 240	1 5020 078 040	42,5	M 40 x 1,5	33,0	58,0	44,5	20,0	85,0	55	2,800	10
1 5020 078 250		54,5	M 50 x 1,5	48,5	68,0	54,5	20,0	86,5	65	4,300	10
1 5020 078 263		54,5	M 63 x 1,5	48,5	68,0	69,0	25,0	91,0	65	9,500	10

RQG2 – P		PG DIN 40430		[IP 68   69K]							
1 5020 081 209	1 5020 081 009	13,0	9	10,0	20,5	21,0	11,5	33,5	18	0,680	50
1 5020 081 211	1 5020 081 011	15,8	11	12,5	23,0	23,0	15,0	39,5	21	1,000	50
1 5020 081 216	1 5020 081 016	21,2	16	17,0	29,5	27,5	16,0	45,0	27	1,380	50
1 5020 081 221	1 5020 081 021	28,5	21	23,5	37,0	33,5	22,0	49,0	34	2,040	25
1 5020 081 229	1 5020 081 029	34,5	29	30,5	44,0	41,0	18,0	52,0	40	2,600	10
1 5020 081 236	1 5020 081 036	42,5	36	36,5	58,0	52,0	20,0	91,0	55	6,800	10
1 5020 081 248	1 5020 081 048	54,5	48	45,0	68,0	64,0	16,0	90,0	65	9,200	10

RQG2 – N		NPT ANSI/ASME B1.20.1		[IP 68   69K]							
1 5020 080 208		21,2	1/2"	17,8	29,5	23,0	12,0	52,5	27	1,560	50
1 5020 080 214		28,5	3/4"	23,5	37,0	24,0	14,0	54,0	34	2,440	25
1 5020 080 218		34,5	1"	34,5	44,0	30,0	16,0	56,0	40	3,000	10
1 5020 080 217		42,5	1 1/4"	30,0	52,0	48,5	18,0	58,5	49	3,200	10
1 5020 080 209		54,5	1 1/2"	37,5	64,0	54,5	18,0	65,5	60	4,500	10

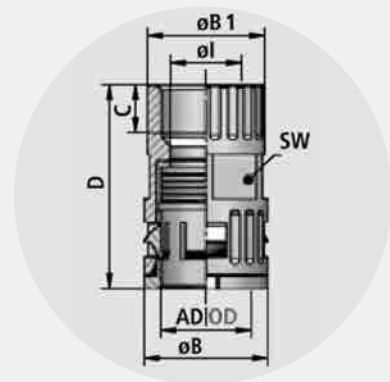

IP 68 | IP 69K  
-40°C ... +120°C

EN / IEC 61386-23  
UL 1696 | CSA 22.2  
UR file E86359  
EN 45545-2 [HL 2]  
ASTM E162 | E662  
SMP 800-C  
Lloyds Register | Gost

# RQG2

Kunststoff-Schnellverschraubung  
gerade  
Innengewinde  
hochdichtend

Plastic connector, quick-type  
straight  
inner thread  
high-density

## EIGENSCHAFTEN

- beständig gegen Öl und Benzin
- weitgehend säure- und lösungsmittelbeständig
- silikon-, cadmium- und halogenfrei

## PROPERTIES

- resistant against oil and benzene
- widely resistant to acids and solvents
- free of silicone, cadmium, halogen



VIDEO

FLEXA No.

AD  
OD



schwarz  
black

ø

øl  
mm

øB  
mm

øB 1  
mm

C  
mm

D  
mm

SW  
mm

kg|100

St.  
pcs.

## RQG2-U

UNEF  
ANSI/ASME 81.1

[IP 68|69K]

FLEXA No.	AD	OD	øl	øB	øB 1	C	D	SW	kg 100	St. pcs.		
1 5020 047 202	13,0	1/2"	(0,500)	-28	10,0	20,0	17,0	8,0	36,6	18	0,500	50
1 5020 047 203	13,0	5/8"	(0,625)	-24	10,0	20,0	20,6	8,0	36,6	18	0,600	50
1 5020 047 205	13,0	3/4"	(0,750)	-20	10,0	20,0	23,0	9,5	38,5	18	0,700	50
1 5020 047 204	15,8	5/8"	(0,625)	-24	12,5	23,0	23,6	9,5	40,0	21	0,760	50
1 5020 047 232	15,8	11/16"	(0,6875)	-24	12,5	23,0	23,6	9,5	46,0	21	0,800	50
1 5020 047 206	15,8	3/4"	(0,750)	-20	12,5	23,0	23,6	9,5	41,7	21	0,940	50
1 5020 047 225	15,8	15/16"	(0,9375)	-20	12,5	23,0	30,0	9,5	45,5	21	1,300	50
1 5020 047 210	15,8	1"	(1,000)	-20	12,5	23,0	30,0	9,5	45,5	21	1,100	50
1 5020 047 239	21,2	9/16"	(0,5625)	-24	12,5	29,5	20,0	8,0	44,6	27	1,100	50
1 5020 047 207	21,2	5/8"	(0,625)	-24	12,5	29,5	30,1	9,5	45,0	27	1,100	50
1 5020 047 227	21,2	3/4"	(0,75)	-20	12,5	29,5	30,0	9,5	51,5	27	1,400	50
1 5020 047 208	21,2	7/8"	(0,875)	-20	17,0	29,5	29,5	9,5	50,5	27	1,540	50
1 5020 047 209	21,2	15/16"	(0,9375)	-20	17,0	29,5	30,1	9,5	50,3	27	1,780	50
1 5020 047 211	21,2	1"	(1,000)	-20	17,0	29,5	30,1	9,5	50,3	27	1,720	50
1 5020 047 230	21,2	1 1/8"	(1,125)	-18	17,0	29,5	33,5	9,5	52,5	27	1,700	50
1 5020 047 212	21,2	1 3/16"	(1,1875)	-18	17,0	29,5	34,6	9,5	52,3	27	1,980	50
1 5020 047 222	21,2	1 3/8"	(1,375)	-18	17,0	29,5	41,0	9,5	52,5	27	2,200	50
1 5020 047 215	21,2	1 7/16"	(1,4375)	-18	17,0	29,5	41,0	9,5	52,5	27	1,900	50
1 5020 047 219	21,2	1 3/4"	(1,750)	-18	17,0	29,5	49,0	9,5	52,5	27	2,560	50
1 5020 047 223	28,5	15/16"	(0,9375)	-20	17,0	37,0	37,0	9,5	52,5	34	2,250	25
1 5020 047 214	28,5	1"	(1,000)	-20	23,5	37,0	37,0	9,5	54,0	34	2,200	25
1 5020 047 213	28,5	1 3/16"	(1,1875)	-18	23,5	37,0	37,0	9,5	52,5	34	2,240	25
1 5020 047 216	28,5	1 3/8"	(1,375)	-18	23,5	37,0	41,0	9,5	54,0	34	2,680	25
1 5020 047 217	28,5	1 7/16"	(1,4375)	-18	23,5	37,0	41,0	9,5	54,0	34	2,480	25
1 5020 047 236	28,5	1 3/4"	(1,750)	-18	23,5	37,0	49,0	9,5	54,0	34	3,000	25
1 5020 047 233	34,5	1"	(1,000)	-20	23,5	44,0	43,5	9,5	56,0	40	2,300	10
1 5020 047 234	34,5	1 3/16"	(1,1875)	-18	17,0	44,0	43,5	9,5	56,0	40	3,000	10
1 5020 047 224	34,5	1 3/8"	(1,375)	-18	23,5	44,0	52,0	9,5	56,0	40	3,200	10
1 5020 047 218	34,5	1 7/16"	(1,4375)	-18	30,5	44,0	44,0	9,5	55,0	40	2,800	10
1 5020 047 249	34,5	1 5/8"	(1,625)	-18	30,5	44,0	46,0	9,5	56,0	40	2,200	10
1 5020 047 220	34,5	1 3/4"	(1,750)	-18	30,5	44,0	49,0	9,5	56,0	40	2,900	10
1 5020 047 221	34,5	2"	(2,000)	-18	30,5	44,0	55,0	9,5	56,0	40	3,200	10
1 5020 047 231	42,5	1 3/16"	(1,1875)	-18	23,0	52,0	52,0	9,5	56,0	48	4,100	10
1 5020 047 228	42,5	1 7/16"	(1,4375)	-18	30,5	52,0	52,0	9,5	57,0	48	3,100	10
1 5020 047 229	42,5	1 3/4"	(1,750)	-18	30,5	52,0	52,0	9,5	58,5	48	4,200	10
1 5020 047 238	42,5	2"	(2,000)	-18	30,5	52,0	54,5	9,5	60,0	48	4,300	10
1 5020 047 237	42,5	2 1/4"	(2,25)	-16	30,5	52,0	66,5	18,0	70,0	48	5,500	10
1 5020 047 235	54,5	2 1/4"	(2,25)	-16	49,5	64,0	66,5	18,0	70,0	60	6,100	10

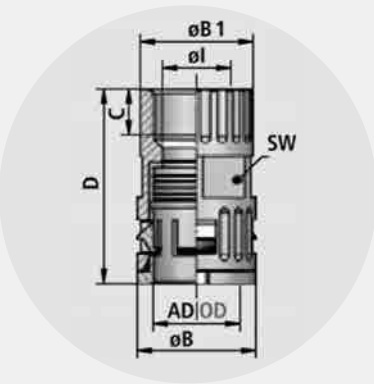

# RQGK2

Kunststoff-Schnellverschraubung  
gerade  
Messinginnengewinde  
hochdichtend

Plastic connector, quick-type  
straight  
nickel-plated brass inner thread  
high-density

## EIGENSCHAFTEN

- beständig gegen Öl und Benzin
- weitgehend säure- und lösungsmittelbeständig
- silikon-, cadmium- und halogenfrei
- hohe mechanische Belastbarkeit
- Schlagfestigkeit
- hohes Drehmoment des Gewindeanschlusses

## PROPERTIES

- resistant against oil and benzine
- widely resistant to acids and solvents
- free of silicone, cadmium, halogen
- fit for high mechanical stress
- impact-resistant
- high torque of thread connection

IP 68 | IP 69K  
-40°C ... +120°C

EN / IEC 61386-23



UL 1696 | CSA 22.2  
UR file E86359



EN 45545-2 [HL 3]



ASTM E162 | E662  
SMP 800-C



Lloyds Register | Gost



VIDEO



FLEXA No.

AD  
OD



schwarz  
black

ø

øl  
mm

øB  
mm

C  
mm

D  
mm

SW  
mm

kg|100

St.  
pcs.

## RQGK2 – M

Metr.  
EN 60423

[IP 68 | 69K]

FLEXA No.	AD	øl	øB	C	D	SW	kg 100	St.
1 5108 010 212	10,0	M 12 x 1,5	7,0	20,0	7,5	38,5	1,500	50
1 5108 013 216	13,0	M 16 x 1,5	8,5	24,0	9,0	42,0	2,420	50
1 5108 015 220	15,8	M 20 x 1,5	11,0	27,0	9,5	43,5	3,140	50
1 5108 021 220	21,2	M 20 x 1,5	15,0	33,0	12,0	50,0	4,800	25
1 5108 021 225	21,2	M 25 x 1,5	16,0	33,0	11,0	50,0	2,600	25
1 5108 028 225	28,5	M 25 x 1,5	18,0	43,0	13,0	53,0	5,080	25
1 5108 028 232	28,5	M 32 x 1,5	20,0	43,0	12,0	53,0	5,900	25
1 5108 034 232	34,5	M 32 x 1,5	24,0	48,0	12,0	57,0	6,880	25
1 5108 034 240	34,5	M 40 x 1,5	27,5	49,0	15,0	60,0	6,300	25
1 5108 042 240	42,5	M 40 x 1,5	32,0	58,0	15,0	62,0	10,000	10
1 5108 042 250	42,5	M 50 x 1,5	36,0	60,0	15,0	86,5	11,000	10
1 5108 054 250	54,5	M 50 x 1,5	39,0	68,0	15,0	95,0	17,000	10
1 5108 054 263	54,5	M 63 x 1,5	47,5	73,0	17,0	95,5	18,600	10

## RQGK2 – P

PG  
DIN 40430

[IP 68 | 69K]

FLEXA No.	AD	øl	øB	C	D	SW	kg 100	St.
1 5020 075 207*	10,0	7	7,0	20,0	8,0	38,0	0,900	50
1 5020 075 209*	13,0	9	8,5	24,0	9,5	41,0	1,500	50
1 5020 075 211*	15,8	11	11,0	27,0	9,0	43,0	2,300	50
1 5020 075 213*	18,5	13,5	12,5	29,0	9,5	45,0	2,640	50
1 5020 075 216*	21,2	16	15,0	33,0	13,0	49,0	3,160	25
1 5020 075 221*	28,5	21	18,5	41,0	13,0	48,0	4,400	25
1 5020 075 229*	34,5	29	27,5	48,0	14,0	56,5	6,840	25
1 5020 075 236*	42,5	36	36,0	59,0	15,5	85,0	10,300	10
1 5020 075 248*	54,5	48	38,5	60,0	16,0	98,0	17,300	10

\* Lieferzeit auf Anfrage Delivery time on request

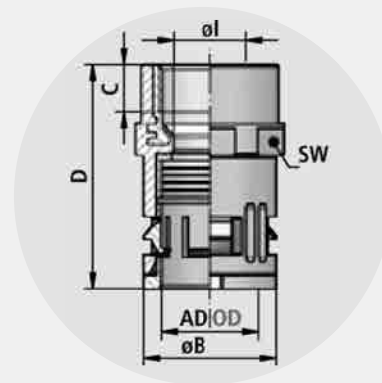

IP 66  
-40°C ... +120°C

EN / IEC 61386-23



UL 1696 | CSA 22.2  
UR file E86359



ASTM E162|E662  
SMP 800-C



Lloyds Register | Gost



VIDEO

# RQG3

Kunststoff-Schnellverschraubung  
gerade, Innengewinde  
konisch dichtend

Plastic connector, quick-type  
straight, inner thread  
conically sealed

## EIGENSCHAFTEN

- beständig gegen Öl und Benzin
- weitgehend säure- und lösungsmittelbeständig
- silikon-, cadmium- und halogenfrei

## PROPERTIES

- resistant against oil and benzene
- widely resistant to acids and solvents
- free of silicone, cadmium, halogen

FLEXA No.	AD OD										
schwarz black	ø		øl mm	øB mm	øB 1 mm	C mm	D mm	SW mm	kg 100	St. pcs.	
		<b>RQG3-M</b>									
		Metr. EN 60423									[IP 66]
1 5020 079 215	13,0	M 12 x 1,5	10,0	20,0	23,0	9,5	34,5	18	0,580	50	
1 5020 079 214	13,0	M 16 x 1,5	10,0	20,0	21,0	9,5	36,5	18	0,660	50	
1 5020 079 216	15,8	M 16 x 1,5	12,5	23,0	21,0	9,5	39,0	21	0,780	50	
1 5020 079 220	21,2	M 20 x 1,5	16,5	29,5	24,0	12,5	49,0	27	1,280	50	
1 5020 079 225	28,5	M 25 x 1,5	17,0	37,0	30,0	13,5	54,0	34	2,120	25	
1 5020 079 232	34,5	M 32 x 1,5	24,0	44,0	35,0	15,0	55,5	40	2,680	10	
1 5020 079 240	42,5	M 40 x 1,5	33,0	52,0	44,5	20,0	63,0	50	3,400	10	
		<b>RQG3-U</b>									
		UNEF ANSI/ASME 81.1									[IP 66]
1 5020 054 202	13,0	1/2" (0,500) -28	10,0	20,0	17,0	8,0	36,6	18	0,560	50	
1 5020 054 203	13,0	5/8" (0,625) -24	10,0	20,0	20,6	8,0	36,6	18	0,640	50	
1 5020 054 205	13,0	3/4" (0,750) -20	10,0	20,0	23,0	9,5	38,5	18	0,840	50	
1 5020 054 204	15,8	5/8" (0,625) -24	12,5	23,0	23,6	9,5	40,0	21	0,810	50	
1 5020 054 232	15,8	1 1/16" (0,6875) -24	12,5	23,0	23,6	9,5	46,0	21	1,000	50	
1 5020 054 206	15,8	3/4" (0,750) -20	12,5	23,0	23,6	9,5	41,7	21	0,940	50	
1 5020 054 225	15,8	15/16" (0,9375) -20	12,5	23,0	30,0	9,5	45,5	21	1,340	50	
1 5020 054 210	15,8	1" (1,000) -20	12,5	23,0	30,0	9,5	45,5	21	1,340	50	
1 5020 054 239	21,2	9/16" (0,5625) -24	12,5	29,5	20,0	8,0	44,6	27	1,100	50	
1 5020 054 207	21,2	5/8" (0,625) -24	12,5	29,5	30,1	9,5	45,0	27	1,100	50	
1 5020 054 227	21,2	3/4" (0,75) -20	12,5	29,5	30,0	9,5	51,5	27	1,350	50	
1 5020 054 208	21,2	7/8" (0,875) -20	17,0	29,5	29,5	9,5	50,5	27	1,480	50	
1 5020 054 209	21,2	15/16" (0,9375) -20	17,0	29,5	30,1	9,5	50,3	27	1,820	50	
1 5020 054 211	21,2	1" (1,000) -20	17,0	29,5	30,1	9,5	50,3	27	1,660	50	
1 5020 054 226	21,2	1 1/8" (1,125) -18	17,0	29,5	33,5	9,5	52,5	27	1,740	50	
1 5020 054 212	21,2	1 3/16" (1,1875) -18	17,0	29,5	34,6	9,5	52,3	27	1,700	50	
1 5020 054 222	21,2	1 3/8" (1,375) -18	17,0	29,5	41,0	9,5	52,5	27	2,300	50	
1 5020 054 215	21,2	1 7/16" (1,4375) -18	17,0	29,5	41,0	9,5	52,5	27	2,100	50	
1 5020 054 219	21,2	1 3/4" (1,750) -18	17,0	29,5	49,0	9,5	52,5	27	2,480	50	
1 5020 054 223	28,5	15/16" (0,9375) -20	17,0	37,0	37,0	9,5	52,5	34	2,320	25	
1 5020 054 214	28,5	1" (1,000) -20	23,5	37,0	37,0	9,5	54,0	34	2,080	25	
1 5020 054 213	28,5	1 3/16" (1,1875) -18	23,5	37,0	37,0	9,5	52,5	34	2,160	25	
1 5020 054 216	28,5	1 3/8" (1,375) -18	23,5	37,0	41,0	9,5	54,0	34	2,680	25	
1 5020 054 217	28,5	1 7/16" (1,4375) -18	23,5	37,0	41,0	9,5	54,0	34	2,600	25	
1 5020 054 236	28,5	1 3/4" (1,750) -18	23,5	37,0	49,0	9,5	54,0	34	2,300	25	
1 5020 054 233	34,5	1" (1,000) -20	23,5	44,0	43,5	9,5	56,0	40	2,300	10	
1 5020 054 234	34,5	1 3/16" (1,1875) -18	17,0	44,0	43,5	9,5	56,0	40	2,300	10	
1 5020 054 224	34,5	1 3/8" (1,375) -18	23,5	44,0	52,0	9,5	56,0	40	3,300	10	
1 5020 054 218	34,5	1 7/16" (1,4375) -18	30,5	44,0	44,0	9,5	55,0	40	2,800	10	
1 5020 054 220	34,5	1 3/4" (1,750) -18	30,5	44,0	49,0	9,5	56,0	40	3,100	10	
1 5020 054 221	34,5	2" (2,000) -18	30,5	44,0	55,0	9,5	56,0	40	3,250	10	
1 5020 054 231	42,5	1 3/16" (1,1875) -18	23,0	52,0	52,0	9,5	56,0	48	3,100	10	
1 5020 054 228	42,5	1 7/16" (1,4375) -18	30,5	52,0	52,0	9,5	57,0	48	3,100	10	
1 5020 054 229	42,5	1 3/4" (1,75) -18	30,5	52,0	52,0	9,5	58,5	48	3,100	10	
1 5020 054 238	42,5	2" (2,000) -18	30,5	52,0	54,5	9,5	60,0	48	4,180	10	
1 5020 054 237	42,5	2 1/4" (2,25) -16	30,5	52,0	66,5	18,0	70,0	48	4,500	10	
1 5020 054 235	54,5	2 1/4" (2,25) -16	49,5	64,0	66,5	18,0	70,0	60	5,000	10	

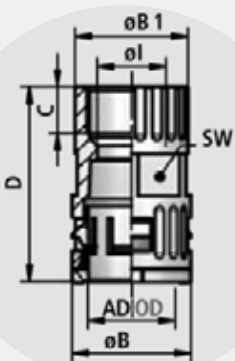

# RQGZ-S

Kunststoff-Schnellverschraubung  
gerade, Steckanschluss, Zugentlastung  
hochdichtend

🔥 IP 68 | IP 69K  
🌡️ -40°C ... +120°C

Plastic connector, quick-type  
straight, plug-type connection  
strain relief, high-density

ASTM E162|E662  
SMP 800-C



## EIGENSCHAFTEN

- kleinstmögliche Außenmaße für minimalsten Verschraubungsabstand
- schnelle Montage ohne Gegenmutter
- für Wandstärken 1,0 bis 4,0 mm
- selbstverlöschend
- hohe mechanische Belastbarkeit
- silikon-, cadmium- und halogenfrei

## PROPERTIES

- smallest outer dimensions to be used under confined conditions
- for quick assembly without counternut
- for wall thicknesses from 1.0 to 4.0 mm
- self-extinguishing
- fit for high mechanical stress
- free of silicone, cadmium, halogen



FLEXA No.

AD  
OD

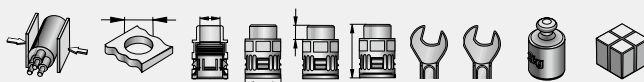

schwarz  
black

ø

mm

ø

mm

øl

mm

øB

mm

C

mm

D

mm

SW1

mm

SW2

mm

kg|100

## RQGZ-S

[IP 68 | 69K]

FLEXA No.	AD	ø	øl	øB	C	D	SW1	SW2	kg 100	St.	
1 5130 013 216	13,0	5,0 - 10,0	16,2	6,0	27,0	8,5	65,0	18	24	1,700	20
1 5130 015 220	15,8	8,0 - 13,0	20,2	8,0	29,0	8,5	72,0	21	26	2,160	20
1 5130 021 225	21,2	11,0 - 17,0	25,2	11,0	36,0	8,5	81,0	27	32	3,820	10
1 5130 028 232	28,5	15,0 - 21,0	32,2	15,0	46,0	11,0	90,0	34	42	5,950	10

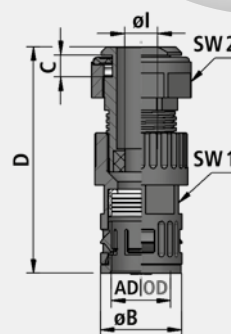

VIDEO

# RQG1-S

Kunststoff-Schnellverschraubung  
gerade, Steckanschluss  
inkl. O-Ring, konisch dichtend

🔥 IP 66  
🌡️ -40°C ... +120°C

Plastic connector, quick-type  
straight, plug-type connection  
incl. O-ring, conically sealed

EN / IEC 61386-23



UL 1696 | CSA 22.2  
UR file E86359  
ASTM E162|E662  
SMP 800-C



## EIGENSCHAFTEN

- schnelle Montage ohne Gegenmutter
- für Wandstärken 1,0 bis 2,5 mm
- beständig gegen Öl und Benzin
- weitgehend säure- und lösungsmittelbeständig
- silikon-, cadmium- und halogenfrei

## PROPERTIES

- for quick assembly without counternut
- for wall thicknesses from 1.0 to 2.5 mm
- resistant against oil and benzine
- widely resistant to acids and solvents
- free of silicone, cadmium, halogen



FLEXA No.

FLEXA No.

AD  
OD



schwarz  
black

grau  
grey

ø

mm

øl

mm

øB

mm

C

mm

D

mm

SW

mm

kg|100

St.

pcs.

## RQG1-S

[IP 66]

FLEXA No.	FLEXA No.	AD	ø	øl	øB	C	D	SW	kg 100	St.
1 5020 082 207		10,0	12,0	7,0	17,0	11,7	34,5	16	0,440	50
1 5020 382 212		13,0	12,0	9,0	20,0	12,0	37,0	18	0,600	50
1 5020 082 209	1 5020 082 009	13,0	15,0	10,0	20,0	13,6	38,6	18	0,600	50
1 5020 382 216	1 5020 382 016	15,8	16,0	11,8	23,0	13,5	40,5	21	0,700	50
1 5020 082 211		15,8	18,0	12,5	23,0	13,5	40,5	21	0,760	50
1 5020 382 220		21,2	20,0	15,2	29,5	13,8	45,3	27	1,100	50
1 5020 082 216	1 5020 082 016	21,2	22,0	18,0	29,5	13,8	45,3	27	1,240	50
1 5020 082 221	1 5020 082 021	28,5	28,0	23,5	37,0	17,9	51,9	34	2,320	25
1 5020 382 225		28,5	25,0	21,0	37,0	17,5	51,0	34	1,920	25
1 5020 082 229		34,5	37,0	30,5	44,0	18,7	54,7	40	2,480	25
1 5020 082 236		42,5	47,0	36,5	52,0	21,0	60,0	49	2,700	25
1 5020 382 250		54,5	50,0	43,0	64,0	21,0	63,0	59	3,700	10

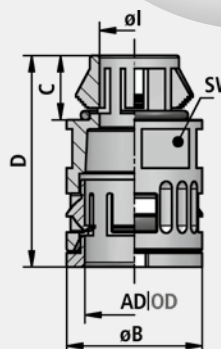

VIDEO

IP 68 | IP 69K  
-40°C ... +120°C

UL 1696 | CSA 22.2  
UR file E86359  
ASTM E162 | E662  
SMP 800-C



VIDEO

## RQGST

Kunststoff-Schnellverschraubung  
gerade  
mit Schlauchschelle  
hochdichtend  
Verbindung auf Installationsrohr

Plastic connector, quick-type  
straight  
incl. conduit clamp  
high-density  
connection to solid tube

### EIGENSCHAFTEN

- zur Verbindung mit metrischem starren Installationsrohr
- inkl. Schlauchschelle
- beständig gegen Öl und Benzin
- weitgehend säure- und lösungsmittelbeständig
- silikon-, cadmium- und halogenfrei

### PROPERTIES

- to connect with metric solid installation tube
- incl. conduit clamp
- resistant against oil and benzene
- widely resistant to acids and solvents
- free of silicone, cadmium, halogen

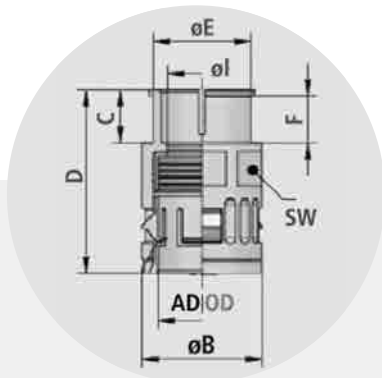

### FLEXA No.

schwarz  
black

AD Rohr AD  
OD tube OD

ø



øI



øB



C



D



øE



F



SW



kg|100



St.



pcs.

### RQGST

[IP 68 | 69K]

FLEXA No.	ø	øI	øB	C	D	øE	F	SW	kg 100	St.	
1 5604 015 216	15,8	16,0	12,5	23,0	13,0	41,0	20,0	11,5	21	0,750	50
1 5604 021 220	21,2	20,0	17,0	29,5	13,0	45,0	24,0	11,5	27	1,150	50
1 5604 028 225	28,5	25,0	20,5	37,0	15,0	49,5	29,0	13,5	34	1,700	25
1 5604 034 232	34,5	32,0	25,5	44,0	15,0	52,5	36,0	13,5	40	2,200	25
1 5604 042 240	42,5	40,0	32,0	52,0	16,5	54,5	44,0	14,0	49	3,100	25
1 5604 054 250	54,5	50,0	42,5	64,0	17,0	55,5	54,0	14,5	60	4,000	10



# RQG–Duo

Kunststoff-Schnellverschraubung  
gerade  
teilbar  
Außengewinde  
speziell für ROHRflex-Duo Schutzschlauch

Plastic connector  
straight  
separable  
outer thread  
especially for ROHRflex-Duo tubings

IP 50  
-40°C ... +120°C



## MATERIAL

Kunststoff [PA 6 mod.]

## MATERIAL

plastics [PA 6 mod.]

## EIGENSCHAFTEN

- zum Schutz vorkonfektionierter Leitungen
- für die nachträgliche Installation
- einfache Montage | Demontage
- IP 50 nach EN / IEC 60529

## PROPERTIES

- to protect pre-assembled cables
- for retrospective installation or repairs
- simple assembly | disassembly
- IP 50 acc. to EN / IEC 60529



FLEXA No.

AD  
OD



schwarz  
black

ø

øl  
mm

øB  
mm

C  
mm

D  
mm

SW  
mm

kg|100

St.  
pcs.

## RQG–Duo–M

Metr.  
EN 60423

[IP 50]

FLEXA No.	AD OD	Metr. EN 60423	øl mm	øB mm	C mm	D mm	SW mm	kg 100	St. pcs.
1 5128 015 216	15,8	M 16 x 1,5	11,0	30,0	15,0	30,0	26	0,750	10
1 5128 015 220	15,8	M 20 x 1,5	15,0	30,0	15,0	30,0	26	0,780	10
1 5128 021 220	21,2	M 20 x 1,5	15,0	32,0	15,0	30,0	28	0,850	10
1 5128 021 225	21,2	M 25 x 1,5	21,0	32,0	15,0	30,0	28	0,800	10
1 5128 028 225	28,5	M 25 x 1,5	21,0	40,0	15,0	35,0	36	1,300	10
1 5128 028 232	28,5	M 32 x 1,5	27,0	40,0	15,0	35,0	36	1,200	5
1 5128 034 232	34,5	M 32 x 1,5	27,0	50,0	15,0	35,0	46	2,400	5
1 5128 034 240	34,5	M 40 x 1,5	35,0	50,0	15,0	35,0	46	2,300	5
1 5128 042 240	42,5	M 40 x 1,5	35,0	62,0	15,0	35,0	55	2,800	5
1 5128 042 250	42,5	M 50 x 1,5	44,0	62,0	20,0	40,0	55	2,700	5
1 5128 054 250	54,5	M 50 x 1,5	44,0	72,0	20,0	45,0	65	3,300	5
1 5128 054 263	54,5	M 63 x 1,5	57,0	72,0	20,0	45,0	65	3,500	5

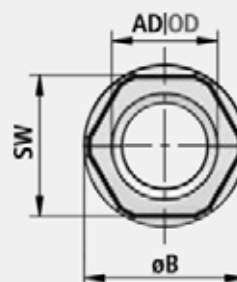
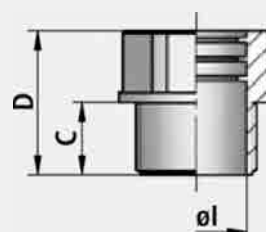



IP 66  
-40°C ... +120°C



VIDEO

## RGE-M

Metall-Sicherheitsverschraubung  
gerade, Außengewinde  
für EMV Anwendungen  
inkl. Spezialdichtung, Messing-Druckring  
und O-Ring für ROHRflex PA 6-CU

Metal connector, safety-type  
straight, outer thread  
for EMC applications  
incl. special sealing, brass thrust collar  
and O-ring for ROHRflex PA 6-CU

### MATERIAL

Gehäuse Messing vernickelt  
Druckring Messing  
Dichteinsatz TPE  
Druckmutter Messing vernickelt  
O-Ring NBR

### MATERIAL

connector body nickel-plated brass  
thrust collar brass  
sealing TPE  
pressure nut nickel-plated brass  
O-Ring NBR

### KONSTRUKTION

Verschraubungsgehäuse mit Sechskant-schlüsselfläche, feststehendes Anschluss-gewinde metrisch, Sechskant-Druckmutter, Messing-Druckring, Dichteinsatz [TPE] und O-Ring

### STRUCTURE

Connector body with hexagonal wrench surface, fixed connecting thread metric, hexagonal pressure nut, brass thrust collar, sealing [TPE] and O-ring

### EIGENSCHAFTEN

- hoher Staub- | Flüssigkeitsschutz
- kraftschlüssige Verbindung von Schlauch und Verschraubung
- Abdeckung der Schlauchenden
- optimale Schirmauflage bei gleichzeitig hoher Dichtigkeit

### PROPERTIES

- highly watertight and dustproof
- friction-type locking of conduit and screw connector
- covered conduit ends
- optimal shielding with high-density

### WICHTIG

Für EMV-Anwendungen bitte die Montageanleitung beachten.

### IMPORTANT

For EMC-usage please see our assembly instructions.

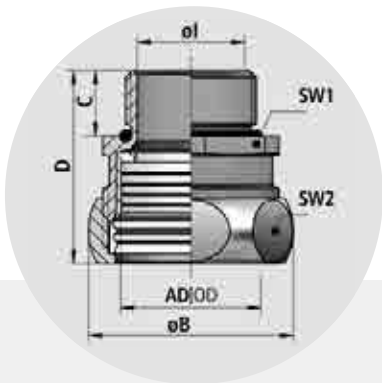

FLEXA No.

AD  
OD  
ø



mm

øl  
mm

øB  
mm

C  
mm

D  
mm

SW1  
mm

SW2  
mm

kg|100

St.  
pcs.

### RGE-M

Met.  
EN 60423

[IP 66]

1 5126 013 012*	13,0	M 12 x 1,5	10,0 x 14,0	9,0	23,0	10,0	28,0	19	21	2,100	10
1 5126 015 016*	15,8	M 16 x 1,5	12,0 x 17,0	13,0	27,0	10,0	29,0	23	25	3,300	10
1 5126 021 020*	21,2	M 20 x 1,5	16,0 x 23,0	16,5	31,0	10,0	30,0	27	29	3,900	10
1 5126 034 032*	34,5	M 32 x 1,5	27,5 x 36,0	27,5	48,0	13,0	40,0	43	45	11,000	10
1 5126 042 040*	42,5	M 40 x 1,5	35,5 x 44,0	35,5	57,0	13,0	40,0	52	54	14,900	10
1 5126 054 050*	54,5	M 50 x 1,5	47,0 x 56,0	44,5	70,0	14,0	47,0	52	66	21,500	10

\* Lieferzeit auf Anfrage Delivery time on request

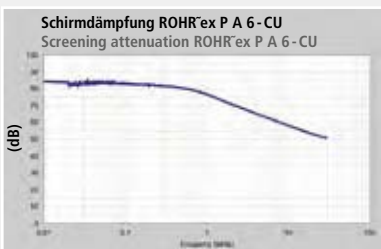

# RQB90

Kunststoff-Schnellverschraubung  
Bogen 90°  
Außengewinde  
hochdichtend

Plastic connector, quick-type  
bend 90°  
outer thread  
high-density

## EIGENSCHAFTEN

- beständig gegen Öl und Benzin
- weitgehend säure- und lösungsmittelbeständig
- silikon-, cadmium- und halogenfrei

## PROPERTIES

- resistant against oil and benzine
- widely resistant to acids and solvents
- free of silicone, cadmium, halogen

IP 68 | IP 69K  
-40°C ... +120°C

EN / IEC 61386-23



UL 1696 | CSA 22.2  
UR file E86359



EN 45545-2 [HL 2]



ASTM E162|E662  
SMP 800-C



Vd / GGVSEB



VIDEO

FLEXA No.	FLEXA No.	AD OD											
schwarz black	grau grey	ø	øl mm	øB mm	C mm	E mm	F mm	SW mm	kg 100	St. pcs.			
<b>RQB90 – M</b>												Metr. EN 60423	[IP 68   69K]
1 5103 010 212	1 5103 010 012	10,0	M 12 x 1,5	6,5	17,0	10,0	57,0	39,0	18	0,800	50		
1 5103 013 216	1 5103 013 016	13,0	M 16 x 1,5	8,5	20,0	12,0	59,0	40,5	21	1,000	50		
1 5103 015 220	1 5103 015 020	15,8	M 20 x 1,5	10,0	23,0	12,0	62,0	45,0	24	1,500	50		
1 5103 021 220	1 5103 021 020	21,2	M 20 x 1,5	13,0	29,5	12,0	73,0	48,0	26	2,000	50		
1 5103 021 225	1 5103 021 025	21,2	M 25 x 1,5	14,5	29,5	13,0	73,0	48,0	26	2,300	50		
1 5103 028 225	1 5103 028 025	28,5	M 25 x 1,5	17,0	37,0	13,0	90,0	64,0	32	3,300	25		
1 5103 028 232	1 5103 028 032	28,5	M 32 x 1,5	20,0	37,0	14,0	85,0	64,0	36	3,400	25		
1 5103 034 232	1 5103 034 032	34,5	M 32 x 1,5	23,0	44,0	14,0	100,5	74,0	39	5,000	10		
1 5103 034 240	1 5103 034 040	34,5	M 40 x 1,5	29,0	44,0	14,0	100,5	74,0	45	5,400	10		
1 5103 042 240	1 5103 042 040	42,5	M 40 x 1,5	31,5	52,0	17,0	111,0	82,5	48	6,700	10		
1 5103 042 250	1 5103 042 050	42,5	M 50 x 1,5	36,0	52,0	17,0	111,0	82,5	59	8,700	10		
1 5103 054 250	1 5103 054 050	54,5	M 50 x 1,5	35,5	64,0	17,0	124,5	98,0	60	10,300	5		
1 5103 054 263	1 5103 054 063	54,5	M 63 x 1,5	45,5	64,0	17,0	124,5	97,0	70	11,700	5		
<b>RQB90 – P</b>												PG DIN 40430	[IP 68   69K]
1 5020 090 207		10,0	7	6,5	17,0	10,0	57,0	39,0	18	0,800	50		
1 5020 090 209		13,0	9	8,5	20,0	12,0	59,0	40,5	21	1,000	50		
1 5020 090 211		15,8	11	10,0	23,0	12,0	62,0	45,0	24	1,300	50		
1 5020 090 213		18,5	13,5	12,5	25,0	12,0	65,0	47,0	27	1,700	50		
1 5020 090 216		21,2	16	14,5	29,5	13,0	73,0	48,0	26	2,100	50		
1 5020 090 221		28,5	21	20,0	37,0	14,0	85,0	64,0	36	3,200	25		
1 5020 090 229		34,5	29	30,0	44,0	14,0	100,5	74,0	45	5,200	10		
1 5020 090 236		42,5	36	36,0	52,0	17,0	108,0	82,5	58	8,300	10		
1 5020 090 248		54,5	48	45,5	64,0	15,5	124,5	97,0	70	11,600	5		
<b>RQB90 – N</b>												NPT ANSI/ASME B1.20.1	[IP 68   69K]
1 5703 013 204		13,0	3/8"	8,5	20,0	12,0	56,5	40,0	21	1,320	50		
1 5020 018 204		15,8	3/8"	10,0	23,0	12,0	59,5	45,0	24	1,550	50		
1 5703 015 205		15,8	1/2"	10,0	23,0	12,0	59,5	45,0	24	1,670	50		
1 5020 018 206		21,2	1/2"	13,0	29,5	12,0	72,5	48,0	26	2,170	50		
1 5020 018 214		28,5	3/4"	17,0	37,0	13,0	87,5	62,5	32	3,410	25		
1 5020 018 216		34,5	1"	23,0	44,0	13,5	95,5	73,0	39	4,850	10		
1 5703 042 217		42,5	1 1/4"	30,5	52,0	17,0	103,5	82,5	48	6,900	10		
1 5020 018 209		54,5	1 1/2"	35,0	64,0	17,0	116,0	96,0	59	9,490	5		
1 5703 054 238		54,5	2"	45,5	64,0	15,5	122,0	96,0	70	10,460	5		

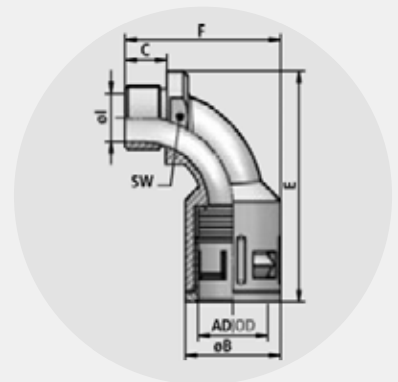

IP 68 | IP 69K  
-40°C ... +120°C

EN / IEC 61386-23

UL 1696 | CSA 22.2  
UR file E86359

EN 45545-2 | HL 3

ASTM E162 | E662  
SMP 800-C

UV REACH RoHS

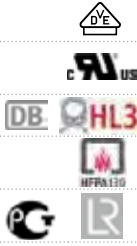

VIDEO

# RQBK90

Kunststoff-Schnellverschraubung  
Bogen 90°  
Messingaußengewinde  
hochdichtend  
inkl. O-Ring [OR] und Flachdichtring [FRH]

Plastic connector, quick-type  
bend 90°  
brass nickel-plated brass outer thread  
high-density  
incl. OR O-ring and FRH flat-sealing

## EIGENSCHAFTEN

- beständig gegen Öl und Benzin
- weitgehend säure- | lösungsmittelbeständig
- silikon-, cadmium- und halogenfrei
- hohe mechanische Belastbarkeit
- Schlagfestigkeit
- hohes Drehmoment des Gewindeanschlusses

## PROPERTIES

- resistant against oil and benzene
- widely resistant to acids and solvents
- free of silicone, cadmium, halogen
- fit for high mechanical stress
- impact-resistant
- high torque of thread connection

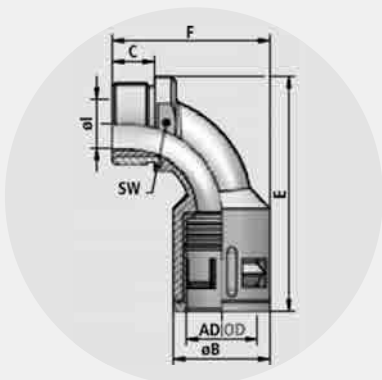

FLEXA No.

AD  
OD



schwarz  
black

ø

øl  
mm

øB  
mm

C  
mm

E  
mm

F  
mm

SW  
mm

kg|100

St.  
pcs.

### RQBK90 – M

Metr.  
EN 60423

[IP 68 | 69K]

1 5105 010 212	10,0	M 12 x 1,5	6,5	17,0	10,0	57,0	39,0	18	1,480	50
1 5105 013 216	13,0	M 16 x 1,5	8,5	20,0	12,0	59,0	40,5	21	1,400	50
1 5105 015 220	15,8	M 20 x 1,5	10,0	23,0	12,0	62,0	45,0	24	2,400	50
1 5105 021 220	21,2	M 20 x 1,5	13,0	29,5	12,0	73,0	48,0	26	3,000	50
1 5105 021 225	21,2	M 25 x 1,5	14,5	29,5	13,0	73,0	48,0	26	3,500	50
1 5105 028 225	28,5	M 25 x 1,5	17,0	37,0	13,0	90,0	64,0	32	4,840	25
1 5105 028 232	28,5	M 32 x 1,5	20,0	37,0	14,0	85,0	64,0	36	6,040	25
1 5105 034 232	34,5	M 32 x 1,5	23,0	44,0	14,0	100,5	74,0	39	8,000	10
1 5105 034 240	34,5	M 40 x 1,5	29,0	44,0	14,0	100,5	74,0	45	8,000	10
1 5105 042 240	42,5	M 40 x 1,5	31,5	52,0	17,0	111,0	82,5	48	16,500	10
1 5105 042 250	42,5	M 50 x 1,5	36,0	52,0	17,0	111,0	82,5	59	16,500	10
1 5105 054 250	54,5	M 50 x 1,5	35,5	64,0	17,0	124,5	98,0	60	19,000	5
1 5105 054 263	54,5	M 63 x 1,5	45,5	64,0	17,0	124,5	98,0	60	24,500	5

### RQBK90 – P

PG  
DIN 40430

[IP 68 | 69K]

1 5020 088 207	10,0	7	6,5	17,0	10,0	57,0	39,0	18	1,340	50
1 5020 088 209	13,0	9	8,5	20,0	12,0	59,0	40,5	21	1,920	50
1 5020 088 211	15,8	11	10,0	23,0	12,0	62,0	45,0	24	2,640	50
1 5020 088 213	18,5	13,5	12,5	25,0	12,0	65,0	47,0	27	2,860	50
1 5020 088 216	21,2	16	14,5	29,5	13,0	73,0	48,0	26	3,080	50
1 5020 088 221	28,5	21	20,0	37,0	14,0	85,0	64,0	36	5,760	25
1 5020 088 229	34,5	29	29,0	44,0	14,0	100,5	74,0	46	8,800	10
1 5020 088 236	42,5	36	36,0	52,0	17,0	111,0	82,5	58	14,800	10
1 5020 088 248	54,5	48	45,5	64,0	17,0	124,5	97,0	70	21,800	5

### RQBK90 – N

NPT  
ANSI/ASME B1.20.1

[IP 68 | 69K]

1 5020 022 205*	15,8	1/2"	10,0	23,0	12,0	62,0	45,0	24	3,000	50
1 5020 022 206*	21,2	1/2"	13,0	29,5	12,0	73,0	48,0	26	3,000	50
1 5020 022 214*	28,5	3/4"	17,0	37,0	14,0	85,0	64,0	22	5,100	25
1 5020 022 216*	34,5	1"	24,5	44,0	14,0	100,5	74,0	31	8,000	10
1 5020 022 217*	42,5	1 1/4"	31,5	52,0	17,0	111,0	82,5	36	12,000	10
1 5020 022 209*	54,5	1 1/2"	37,5	64,0	17,0	124,5	97,0	60	18,000	5
1 5020 022 210*	54,5	2"	45,5	64,0	17,0	124,5	97,0	70	18,300	5

\* Lieferzeit auf Anfrage Delivery time on request

# RQBK90DR

Kunststoff-Schnellverschraubung  
 Bogen 90°  
 drehbares Messingaußengewinde  
 hochdichtend  
 inkl. O-Ring [OR] und Flachdichtring [FRH]

Plastic connector, quick-type  
 bend 90°  
 turnable nickel-plated brass  
 outer thread, high-density  
 incl. OR O-ring and FRH flat-sealing

IP 68 | IP 69K  
 -40°C ... +120°C

## EIGENSCHAFTEN

- beständig gegen Öl und Benzin
- weitgehend säure- | lösungsmittelbeständig
- silikon-, cadmium- und halogenfrei
- hohe mechanische Belastbarkeit
- Schlagfestigkeit
- hohes Drehmoment des Gewindeanschlusses
- Positionierung auch nach der Montage möglich

## PROPERTIES



- resistant against oil and benzine
- widely resistant to acids and solvents
- free of silicone, cadmium, halogen
- fit for high mechanical stress
- impact-resistant
- high torque of thread connection
- swiveling also after installation

EN / IEC 61386-23 

UL 1696 | CSA 22.2  
 UR file E86359 

EN 45545-2 [HL 3]   

ASTM E162 | E662  
 SMP 800-C 



VIDEO



FLEXA No.

AD  
 OD



schwarz  
 black

ø

ø1  
 mm

øB  
 mm

C  
 mm

E  
 mm

F  
 mm

SW  
 mm

kg|100

St.  
 pcs.

### RQBK90DR–M

Metr.  
 EN 60423

[IP 68 | 69K]

1 5121 021 220	21,2	M 20 x 1,5	13,0	29,5	12,0	72,0	62,0	27	6,200	50
1 5121 421 220	21,2	M 20 x 1,5	13,0	29,5	6,0	72,0	56,0	27	5,740	50
1 5121 028 225	28,5	M 25 x 1,5	17,0	37,0	13,0	90,0	80,0	34	11,160	25
1 5121 428 225	28,5	M 25 x 1,5	17,0	37,0	7,0	90,0	74,0	34	10,350	25
1 5121 034 232	34,5	M 32 x 1,5	24,5	44,0	14,0	100,0	91,0	43	16,500	10
1 5121 434 232	34,5	M 32 x 1,5	24,5	44,0	8,0	100,0	85,0	43	15,500	10
1 5121 042 240	42,5	M 40 x 1,5	31,5	52,0	17,0	111,0	103,0	52	28,400	10
1 5121 442 240	42,5	M 40 x 1,5	31,5	52,0	8,0	111,0	94,0	52	26,300	10

### RQBK90DR–P

PG  
 DIN 40430

[IP 68 | 69K]

1 5521 021 216*	21,2	16	13,0	29,5	13,0	72,0	65,0	27	6,200	50
1 5521 028 221*	28,5	21	17,0	37,0	14,0	90,0	81,5	34	11,000	25
1 5521 034 229*	34,5	29	24,5	44,0	14,0	100,0	95,0	43	16,000	10
1 5521 042 236*	42,5	36	31,5	52,0	17,0	110,0	105,0	52	32,900	10

### RQBK90DR–N

NPT  
 ANSI/ASME B1.20.1

[IP 68 | 69K]

1 5020 019 206*	21,2	1/2"	13,0	29,5	13,0	73,0	65,0	27	7,100	50
1 5020 019 214*	28,5	3/4"	17,0	37,0	14,0	90,0	81,5	34	12,000	25
1 5020 019 216*	34,5	1"	24,5	44,0	14,0	100,0	95,0	43	17,400	10
1 5020 019 217*	42,5	1 1/4"	31,5	52,0	17,0	110,0	105,0	52	30,500	10

\* Lieferzeit auf Anfrage Delivery time on request

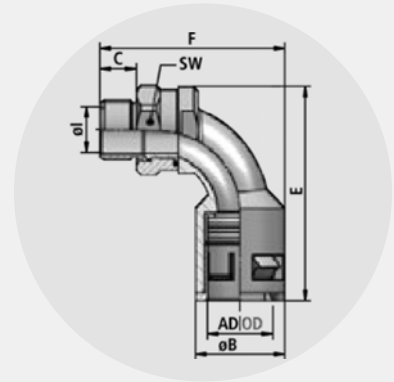

IP 66  
-40°C ... +120°C

EN / IEC 61386-23

UL 1696 | CSA 22.2  
UR file E86359

ASTM E162 | E662  
SMP 800-C



VIDEO

# RQB1 90

Kunststoff-Schnellverschraubung  
Bogen 90°  
Außengewinde  
konisch dichtend

Plastic connector, quick-type  
bend 90°  
outer thread  
conically sealed

## EIGENSCHAFTEN

- beständig gegen Öl und Benzin
- weitgehend säure- und lösungsmittelbeständig
- silikon-, cadmium- und halogenfrei

## PROPERTIES

- resistant against oil and benzene
- widely resistant to acids and solvents
- free of silicone, cadmium, halogen

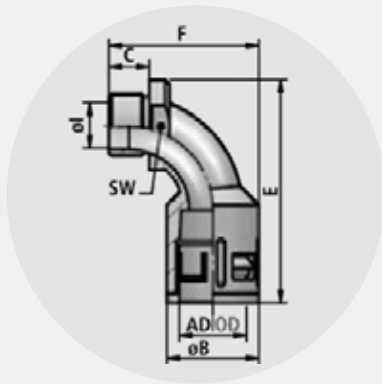

FLEXA No.	FLEXA No.	AD OD										
schwarz black	grau grey	ø		øL mm	øB mm	C mm	E mm	F mm	SW mm	kg 100	St. pcs.	
<b>RQB1 90-M</b>			<b>Metr.</b>									<b>[IP 66]</b>
			<b>EN 60423</b>									
1 5104 010 212		10,0	M 12 x 1,5	6,5	17,0	10,0	57,0	39,0	18	0,900	50	
1 5104 013 216		13,0	M 16 x 1,5	8,5	20,0	12,0	59,0	40,5	21	1,100	50	
1 5104 015 220	1 5104 015 020	15,8	M 20 x 1,5	10,0	23,0	12,0	62,0	45,0	24	1,400	50	
1 5104 021 220	1 5104 021 020	21,2	M 20 x 1,5	13,0	29,5	12,0	73,0	48,0	26	2,100	50	
1 5104 021 225	1 5104 021 025	21,2	M 25 x 1,5	14,5	29,5	13,0	73,0	48,0	26	2,000	50	
1 5104 028 225		28,5	M 25 x 1,5	17,0	37,0	13,0	90,0	64,0	32	3,400	25	
1 5104 028 232	1 5104 028 032	28,5	M 32 x 1,5	20,0	37,0	14,0	85,0	64,0	36	3,500	25	
1 5104 034 232		34,5	M 32 x 1,5	23,0	44,0	14,0	100,5	74,0	39	5,100	10	
1 5104 034 240	1 5104 034 040	34,5	M 40 x 1,5	29,0	44,0	14,0	100,5	74,0	45	5,400	10	
1 5104 042 240		42,5	M 40 x 1,5	31,5	52,0	17,0	111,0	82,5	48	6,600	10	
1 5104 042 250	1 5104 042 050	42,5	M 50 x 1,5	36,0	52,0	17,0	111,0	82,5	59	8,600	10	
1 5104 054 250		54,5	M 50 x 1,5	35,5	64,0	17,0	124,5	98,0	60	11,000	5	
1 5104 054 263	1 5104 054 063	54,5	M 63 x 1,5	45,5	64,0	17,0	124,5	97,0	70	12,200	5	

# RQLB1 90

Kunststoffverschraubung  
Bogen 90°, Außengewinde  
konisch dichtend

Plastic connector  
bend 90°, outer thread  
conically sealed

IP 65  
-40°C ... +120°C

## MATERIAL

Kunststoff [PA modifiziert]

## MATERIAL

plastics [PA modified]

UL 1696 | CSA 22.2  
UR file E86359



ASTM E162|E662  
SMP 800-C



## EIGENSCHAFTEN

- beständig gegen Öl und Benzin
- weitgehend säure- und lösungsmittelbeständig
- silikon-, cadmium- und halogenfrei

## PROPERTIES

- resistant against oil and benzine
- widely resistant to acids and solvents
- free of silicone, cadmium, halogen

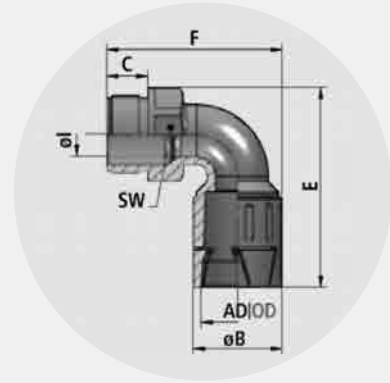

FLEXA No.	FLEXA No.	AD OD										
schwarz black	grau grey	ø		øI mm	øB mm	C mm	E mm	F mm	SW mm	kg 100	St. Pcs.	
<b>RQLB1 90-M</b> <span style="float: right;">[IP 65]</span>												
Metr. EN 60423												
1 5117 013 216	1 5117 013 016	13,0	M 16 x 1,5	10,0	20,0	11,0	47,0	42,5	18	0,100	50	
1 5117 015 220	1 5117 015 020	15,8	M 20 x 1,5	12,5	24,0	11,0	52,0	46,5	22	1,500	50	
1 5117 018 220	1 5117 018 020	18,5	M 20 x 1,5	14,0	26,0	13,0	55,5	51,5	27	1,700	50	
1 5117 018 225	1 5117 018 025	18,5	M 25 x 1,5	14,0	26,0	13,0	55,5	51,5	27	1,700	50	
1 5117 021 220	1 5117 021 020	21,2	M 20 x 1,5	14,0	29,5	13,0	61,8	54,2	27	2,100	50	
1 5117 021 225	1 5117 021 025	21,2	M 25 x 1,5	14,0	29,5	13,0	61,8	54,2	27	2,100	50	
1 5117 028 225	1 5117 028 025	28,5	M 25 x 1,5	18,8	36,0	13,0	71,5	66,7	35	3,200	25	
1 5117 028 232	1 5117 028 032	28,5	M 32 x 1,5	18,8	36,0	13,0	71,5	66,7	35	3,200	25	
1 5117 034 232	1 5117 034 032	34,5	M 32 x 1,5	26,0	44,0	15,0	85,5	71,0	43	4,800	10	
1 5117 034 240	1 5117 034 040	34,5	M 40 x 1,5	26,0	44,0	15,0	85,5	71,0	43	4,800	10	
1 5117 042 240	1 5117 042 040	42,5	M 40 x 1,5	35,0	52,0	16,0	104,5	81,5	53	7,400	10	
1 5117 042 250	1 5117 042 050	42,5	M 50 x 1,5	35,0	52,0	16,0	104,5	81,5	53	7,400	10	
1 5117 054 250	1 5117 054 050	54,5	M 50 x 1,5	45,0	64,0	16,0	122,0	94,8	66	10,600	5	
1 5117 054 263	1 5117 054 063	54,5	M 63 x 1,5	45,0	64,0	16,0	122,0	94,8	66	10,600	5	
<b>RQLB1 90-P</b> <span style="float: right;">[IP 65]</span>												
PG DIN 40430												
1 5517 013 209		13,0	9	10,0	20,0	12,0	47,0	42,5	18	0,500	50	
1 5517 015 211		15,8	11	12,5	24,0	12,0	52,0	46,5	22	0,600	50	
1 5517 018 213		18,5	13,5	14,0	26,0	13,0	55,5	51,5	27	0,800	50	
1 5517 021 216		21,2	16	14,0	29,5	13,0	61,8	54,2	27	1,000	50	
1 5517 028 221		28,5	21	18,8	36,0	15,0	71,5	66,7	35	1,200	25	
1 5517 034 229		34,5	29	26,0	44,0	15,0	85,5	71,0	43	1,700	10	
1 5517 042 236		42,5	36	35,0	52,0	16,0	104,5	81,5	53	2,700	10	
1 5517 054 248		54,5	48	45,0	64,0	16,0	122,0	94,8	66	4,300	10	
<b>RQLB1 90-N</b> <span style="float: right;">[IP 65]</span>												
NPT ANSI/ASME B1.20.1												
1 5717 015 205		15,8	1/2"	12,4	24,0	13,0	51,5	49,0	22	1,500	50	
1 5717 021 205		21,2	1/2"	14,0	29,5	13,0	61,8	54,2	27	2,100	50	
1 5717 028 214		28,5	3/4"	18,8	36,0	12,5	71,5	66,2	35	3,200	10	
1 5717 034 210		34,5	1"	25,7	42,5	15,0	85,0	73,6	42	4,900	10	

IP 68 | IP 69K  
-40°C ... +120°C

EN / IEC 61386-23



UL 1696 | CSA 22.2  
UR file E86359



EN 45545-2 [HL 2]



ASTM E162 | E662  
SMP 800-C



VdL / GGVSEB



VIDEO

## RQB45

Kunststoff-Schnellverschraubung  
Bogen 45°  
Außengewinde  
hochdichtend

Plastic connector, quick-type  
bend 45°  
outer thread  
high-density

### EIGENSCHAFTEN

- beständig gegen Öl und Benzin
- weitgehend säure- und lösungsmittelbeständig
- silikon-, cadmium- und halogenfrei

### PROPERTIES

- resistant against oil and benzene
- widely resistant to acids and solvents
- free of silicone, cadmium, halogen



FLEXA No.	FLEXA No.	AD OD									
schwarz black	grau grey	ø		øI mm	øB mm	C mm	E mm	F mm	SW mm	kg 100	St. pcs.

### RQB45 – M

Metr.  
EN 60423

[IP 68 | 69K]

1 5100 010 212		10,0	M 12 x 1,5	6,5	18,0	10,0	39,0	45,0	18	0,600	50
1 5100 013 216		13,0	M 16 x 1,5	8,5	22,0	12,0	42,5	48,0	21	0,900	50
1 5100 015 220	1 5100 015 020	15,8	M 20 x 1,5	10,0	25,5	12,0	44,5	52,5	24	1,300	50
1 5100 021 220	1 5100 021 020	21,2	M 20 x 1,5	13,0	29,5	12,0	55,0	60,0	26	1,800	50
1 5100 021 225	1 5100 021 025	21,2	M 25 x 1,5	14,5	29,5	13,0	56,0	60,0	26	2,000	50
1 5100 028 225		28,5	M 25 x 1,5	17,0	37,0	13,0	64,0	72,0	32	2,700	25
1 5100 028 232	1 5100 028 032	28,5	M 32 x 1,5	20,0	38,0	14,0	64,0	75,0	36	3,800	25
1 5100 034 232		34,5	M 32 x 1,5	23,0	44,0	14,0	73,5	76,0	39	3,800	10
1 5100 034 240	1 5100 034 040	34,5	M 40 x 1,5	29,0	47,0	14,0	73,5	77,0	45	4,100	10
1 5100 042 240		42,5	M 40 x 1,5	31,5	56,5	17,0	82,5	86,0	48	5,500	10
1 5100 042 250	1 5100 042 050	42,5	M 50 x 1,5	36,0	61,5	17,0	82,5	86,0	58	6,500	10
1 5100 054 250		54,5	M 50 x 1,5	35,5	64,0	17,0	92,0	95,0	58	8,500	5
1 5100 054 263	1 5100 054 063	54,5	M 63 x 1,5	45,5	71,5	17,0	97,0	100,0	69	9,500	5

### RQB45 – P

PG  
DIN 40430

[IP 68 | 69K]

1 5020 089 209		13,0	9	8,5	20,0	12,0	41,0	48,0	21	0,800	50
1 5020 089 211		15,8	11	10,0	23,0	12,0	43,0	51,0	24	1,200	50
1 5020 089 216		21,2	16	14,5	29,5	13,0	54,0	56,0	26	2,000	50
1 5020 089 221		28,5	21	20,0	37,0	14,0	63,0	69,0	36	2,900	25
1 5020 089 229		34,5	29	29,0	44,0	14,0	70,5	73,5	45	4,100	10
1 5020 089 236		42,5	36	36,0	52,0	17,0	81,0	82,5	58	6,000	10
1 5020 089 248		54,5	48	45,0	64,0	17,0	95,0	97,0	69	8,500	5

### RQB45 – N

NPT  
ANSI/ASME B1.20.1

[IP 68 | 69K]

1 5020 017 205		15,8	1/2"	10,0	23,0	12,0	41,0	48,0	23	1,200	50
1 5020 017 206		21,2	1/2"	13,0	29,5	12,0	52,0	55,0	26	1,700	50
1 5020 017 214		28,5	3/4"	17,0	37,0	13,0	68,0	68,0	31	2,600	25
1 5020 017 216		34,5	1"	23,0	44,0	14,0	68,0	73,5	39	3,800	10
1 5020 017 215		34,5	1 1/4"	29,0	44,0	14,0	73,0	73,5	45	4,500	10
1 5020 017 217		42,5	1 1/4"	30,5	52,0	17,0	76,0	80,0	47	5,500	10
1 5020 017 208		42,5	1 1/2"	35,0	52,0	17,0	82,0	81,0	58	6,300	10
1 5020 017 209		54,5	1 1/2"	35,0	64,0	17,0	89,0	94,5	58	8,700	5
1 5020 017 210		54,5	2"	45,0	64,0	17,0	95,5	95,0	69	9,000	5



# RQBK45

Kunststoff-Schnellverschraubung  
 Bogen 45°  
 Messingaußengewinde  
 hochdichtend  
 inkl. O-Ring [OR] und Flachdichtring [FRH]

Plastic connector, quick-type  
 bend 45°  
 nickel-plated brass outer thread  
 high-density  
 incl. OR O-ring and FRH flat-sealing











## EIGENSCHAFTEN

- beständig gegen Öl und Benzin
- weitgehend säure- und lösungsmittelbeständig
- silikon-, cadmium- und halogenfrei
- hohe mechanische Belastbarkeit
- Schlagfestigkeit
- hohes Drehmoment des Gewindeanschlusses

## PROPERTIES

- resistant against oil and benzine
- widely resistant to acids and solvents
- free of silicone, cadmium, halogen
- fit for high mechanical stress
- impact-resistant
- high torque of thread connection

IP 68 | IP 69K  
 -40°C ... +120°C

EN / IEC 61386-23   
 UL 1696 | CSA 22.2   
 UR file E86359  
 EN 45545-2 [HL 3]     
 ASTM E162|E662   
 SMP 800-C  
 Lloyds Register | Gost    
  



VIDEO

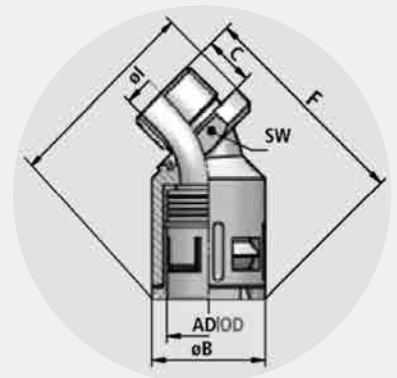

### FLEXA No.

schwarz  
 black

AD  
 OD  
 ø



øl  
 mm

øB  
 mm

C  
 mm

E  
 mm

F  
 mm

SW  
 mm

kg|100

St.  
 pcs.

### RQBK45 – M

Metr.  
 EN 60423

[IP 68|69K]

FLEXA No.	AD	øl	øB	C	E	F	SW	kg 100	St.	
1 5102 010 212	10,0	M 12 x 1,5	6,5	18,0	10,0	39,0	45,0	18	1,140	50
1 5102 013 216	13,0	M 16 x 1,5	8,5	22,0	12,0	42,5	48,0	21	1,760	50
1 5102 015 220	15,8	M 20 x 1,5	10,0	25,5	12,0	44,5	52,5	24	1,700	50
1 5102 021 220	21,2	M 20 x 1,5	13,0	29,5	12,0	55,0	60,0	26	2,540	50
1 5102 021 225	21,2	M 25 x 1,5	14,5	29,5	13,0	56,0	60,0	26	3,800	50
1 5102 028 225	28,5	M 25 x 1,5	17,0	37,0	13,0	64,0	72,0	32	4,000	25
1 5102 028 232	28,5	M 32 x 1,5	20,0	38,0	14,0	64,0	75,0	37	5,640	25
1 5102 034 232	34,5	M 32 x 1,5	23,0	44,0	14,0	73,5	76,0	39	6,700	10
1 5102 034 240	34,5	M 40 x 1,5	29,0	47,0	14,0	73,5	77,0	46	9,000	10
1 5102 042 240	42,5	M 40 x 1,5	31,5	56,5	17,0	82,5	86,0	48	8,700	10
1 5102 042 250	42,5	M 50 x 1,5	36,0	61,5	17,0	82,5	86,0	59	16,500	10
1 5102 054 250	54,5	M 50 x 1,5	35,5	64,0	17,0	92,0	95,0	59	17,400	5
1 5102 054 263	54,5	M 63 x 1,5	45,5	71,5	17,0	97,0	100,0	69	22,500	5

### RQBK45 – P

PG  
 DIN 40430

[IP 68|69K]

FLEXA No.	AD	øl	øB	C	E	F	SW	kg 100	St.	
1 5020 087 209*	13,0	9	8,5	22,0	12,0	42,5	48,0	21	1,700	50
1 5020 087 211*	15,8	11	10,0	25,5	12,0	44,5	52,5	24	2,300	50
1 5020 087 213*	18,5	13,5	12,5	28,0	12,0	49,0	59,0	27	2,620	50
1 5020 087 216*	21,2	16	14,5	29,5	13,0	56,0	60,0	26	2,860	50
1 5020 087 221*	28,5	21	20,0	38,0	14,0	64,0	75,0	36	5,360	25
1 5020 087 229*	34,5	29	29,0	47,0	14,0	73,5	77,0	45	7,700	10
1 5020 087 236*	42,5	36	36,0	61,5	17,0	82,5	86,0	58	12,300	10
1 5020 087 248*	54,5	48	45,5	71,5	17,0	97,0	100,0	70	18,500	5

\* Lieferzeit auf Anfrage Delivery time on request

IP 68 | IP 69K  
-40°C ... +120°C

EN / IEC 61386-23   
 UL 1696 | CSA 22.2   
 UR file E86359  
 EN 45545-2 [HL 3]     
 ASTM E162 | E662   
 SMP 800-C   
   



VIDEO

# RQBK45DR

Kunststoff-Schnellverschraubung  
 Bogen 45°  
 drehbares Messingaußengewinde  
 hochdichtend  
 inkl. O-Ring [OR] und Flachdichtring [FRH]

Plastic connector, quick-type  
 bend 45°  
 turnable nickel-plated brass  
 outer thread, high-density  
 incl. OR O-ring and FRH flat-sealing

## EIGENSCHAFTEN

- beständig gegen Öl und Benzin
- weitgehend säure- | lösungsmittelbeständig
- silikon-, cadmium- und halogenfrei
- hohe mechanische Belastbarkeit
- Schlagfestigkeit
- hohes Drehmoment des Gewindeanschlusses
- Positionierung auch nach der Montage möglich

## PROPERTIES

- resistant against oil and benzene
- widely resistant to acids and solvents
- free of silicone, cadmium, halogen
- fit for high mechanical stress
- impact-resistant
- high torque of thread connection
- swiveling also after installation

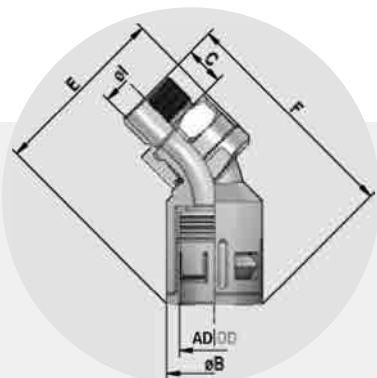

FLEXA No.

AD  
OD



schwarz  
black

ø

øI

øB

C

E

F

SW

kg|100

St.

pcs.

## RQBK45DR-M

Metr.  
EN 60423

[IP 68 | 69K]

FLEXA No.	AD	OD	øI	øB	C	E	F	SW	kg 100	St.
1 5131 021 220	21,2	M 20 x 1,5	13,0	29,5	12,0	54,5	71,5	27	6,200	50
1 5131 421 220	21,2	M 20 x 1,5	13,0	29,5	6,0	54,5	65,5	27	5,740	50
1 5131 028 225	28,5	M 25 x 1,5	17,0	37,0	13,0	66,0	87,0	34	11,060	25
1 5131 428 225	28,5	M 25 x 1,5	17,0	37,0	7,0	66,0	81,0	34	10,350	25
1 5131 034 232	34,5	M 32 x 1,5	24,5	44,0	14,0	74,0	92,0	43	16,500	10
1 5131 434 232	34,5	M 32 x 1,5	24,5	44,0	8,0	74,0	86,0	43	15,500	10
1 5131 042 240	42,5	M 40 x 1,5	31,5	52,0	17,0	85,0	104,0	52	28,400	10
1 5131 442 240	42,5	M 40 x 1,5	31,5	52,0	8,0	85,0	95,0	52	26,300	10

# RQB1 45

Kunststoff-Schnellverschraubung  
Bogen 45°  
Außengewinde  
konisch dichtend

Plastic connector, quick-type  
bend 45°  
outer thread  
conically sealed

## EIGENSCHAFTEN

- beständig gegen Öl und Benzin
- weitgehend säure- und lösungsmittelbeständig
- silikon-, cadmium- und halogenfrei

## PROPERTIES

- resistant against oil and benzine
- widely resistant to acids and solvents
- free of silicone, cadmium, halogen

IP 66  
-40°C ... +120°C

EN / IEC 61386-23



UL 1696 | CSA 22.2  
UR file E86359



ASTM E162|E662  
SMP 800-C



VIDEO



FLEXA No.	FLEXA No.	AD OD									
schwarz black	grau grey	ø	Metr. EN 60423	øL mm	øB mm	C mm	E mm	F mm	SW mm	kg 100	St. pcs.
<b>RQB1 45–M</b>											
											[IP 66]
1 5101 010 212		10,0	M 12 x 1,5	6,5	17,0	10,0	39,0	45,0	18	0,800	50
1 5101 013 216	1 5101 013 016	13,0	M 16 x 1,5	8,5	20,0	12,0	42,5	48,0	21	0,900	50
1 5101 015 220	1 5101 015 020	15,8	M 20 x 1,5	10,0	23,0	12,0	44,5	52,5	24	1,100	50
1 5101 021 220	1 5101 021 020	21,2	M 20 x 1,5	13,0	29,5	12,0	55,0	60,0	26	1,800	50
1 5101 021 225	1 5101 021 025	21,2	M 25 x 1,5	14,5	29,5	13,0	56,0	60,0	26	2,000	50
1 5101 028 225	1 5101 028 025	28,5	M 25 x 1,5	17,0	37,0	13,0	64,0	72,0	32	2,700	25
1 5101 028 232	1 5101 028 032	28,5	M 32 x 1,5	20,0	37,0	14,0	64,0	75,0	36	3,600	25
1 5101 034 232	1 5101 034 032	34,5	M 32 x 1,5	23,0	44,0	14,0	73,5	76,0	39	3,800	10
1 5101 034 240	1 5101 034 040	34,5	M 40 x 1,5	29,0	44,0	14,0	73,5	77,0	45	4,100	10
1 5101 042 240	1 5101 042 040	42,5	M 40 x 1,5	31,5	52,0	17,0	82,5	86,0	48	5,300	10
1 5101 042 250	1 5101 042 050	42,5	M 50 x 1,5	36,0	52,0	17,0	82,5	86,0	58	6,500	10
1 5101 054 250	1 5101 054 050	54,5	M 50 x 1,5	35,5	64,0	17,0	92,0	95,0	58	9,200	5
1 5101 054 263	1 5101 054 063	54,5	M 63 x 1,5	45,5	64,0	17,0	97,0	100,0	69	9,400	5
<b>RQB1 45–N</b>											
											[IP 66]
NPT ANSI/ASME B1 20 1											
1 5701 015 205		15,8	1/2"	10,0	23,0	12,0	44,5	52,5	24	1,200	50
1 5701 021 205		21,2	1/2"	14,5	29,5	12,0	55,0	60,0	26	1,900	50
1 5701 028 214		28,5	3/4"	20,0	37,0	13,0	67,0	70,0	32	2,700	25
1 5701 034 210		34,5	1"	30,0	44,0	14,0	73,5	75,0	39	3,800	10
1 5701 042 217		42,5	1 1/4"	39,0	52,0	17,0	82,5	100,0	48	5,500	10
1 5701 054 209		54,5	1 1/2"	37,5	64,0	17,0	97,0	100,0	59	8,900	5

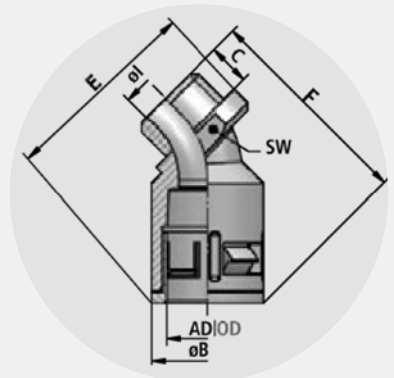

IP 65  
-40°C ... +120°C

UL 1696 | CSA 22.2  
UR file E86359

ASTM E162|E662  
SMP 800-C



# RQLB1 45

Kunststoff-Schnellverschraubung  
Bogen 45°  
Außengewinde  
konisch dichtend

Plastic connector, quick-type  
bend 45°  
outer thread  
conically sealed

## EIGENSCHAFTEN

- beständig gegen Öl und Benzin
- weitgehend säure- und lösungsmittelbeständig
- silikon-, cadmium- und halogenfrei

## PROPERTIES

- resistant against oil and benzene
- widely resistant to acids and solvents
- free of silicone, cadmium, halogen

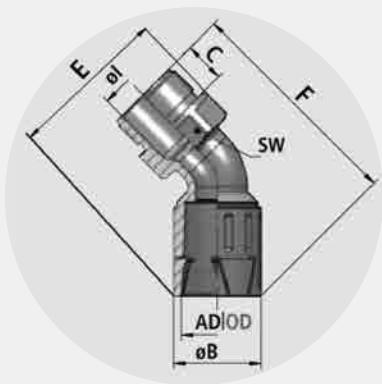

FLEXA No.	FLEXA No.	AD OD									
schwarz black	grau grey	ø		øl mm	øB mm	C mm	E mm	F mm	SW mm	kg 100	St. Pcs.
<b>RQLB1 45-M</b>			<b>Metr.</b> EN 60423								[IP 65]
1 5118 013 216	1 5118 013 016	13,0	M 16 x 1,5	10,0	20,0	11,0	47,0	42,5	18	1,100	50
1 5118 015 220	1 5118 015 020	15,8	M 20 x 1,5	12,5	24,0	11,0	52,0	46,5	22	1,500	50
1 5118 018 220	1 5118 018 020	18,5	M 20 x 1,5	14,0	26,0	13,0	55,5	51,5	27	1,700	50
1 5118 018 225	1 5118 018 025	18,5	M 25 x 1,5	14,0	26,0	13,0	55,5	51,5	27	1,700	50
1 5118 021 220	1 5118 021 020	21,2	M 20 x 1,5	14,0	29,5	13,0	61,8	54,2	27	2,100	50
1 5118 021 225	1 5118 021 025	21,2	M 25 x 1,5	14,0	29,5	13,0	61,8	54,2	27	2,100	50
1 5118 028 225	1 5118 028 025	28,5	M 25 x 1,5	18,8	36,0	13,0	71,5	66,7	35	3,200	25
1 5118 028 232	1 5118 028 032	28,5	M 32 x 1,5	18,8	36,0	13,0	71,5	66,7	35	3,200	25
1 5118 034 232	1 5118 034 032	34,5	M 32 x 1,5	26,0	44,0	15,0	85,5	71,0	43	4,800	10
1 5118 034 240	1 5118 034 040	34,5	M 40 x 1,5	26,0	44,0	15,0	85,5	71,0	43	4,800	10
1 5118 042 240	1 5118 042 040	42,5	M 40 x 1,5	35,0	52,0	16,0	104,5	81,5	53	7,400	10
1 5118 042 250	1 5118 042 050	42,5	M 50 x 1,5	35,0	52,0	16,0	104,5	81,5	53	7,400	10
1 5118 054 263	1 5118 054 063	54,5	M 63 x 1,5	45,0	64,0	16,0	122,0	94,8	66	10,600	5
<b>RQLB1 45-N</b>			<b>NPT</b> ANSI/ASME B1.20.1								[IP 65]
1 5718 015 205		15,8	1/2"	12,4	24,0	13,0	52,0	48,5	22	1,500	50
1 5718 021 205		21,2	1/2"	14,0	29,5	13,0	61,8	54,2	27	2,100	50
1 5718 028 214		28,5	3/4"	18,8	36,0	12,5	71,5	66,2	35	3,200	25
1 5718 034 210		34,5	1"	25,7	44,0	15,0	85,5	71,0	43	4,800	10

# RQW

Kunststoff-Schnellverschraubung  
Winkel 90°  
Außengewinde  
hochdichtend

Plastic connector, quick-type  
elbow 90°  
outer thread  
high-density

## EIGENSCHAFTEN

- beständig gegen Öl und Benzin
- weitgehend säure- und lösungsmittelbeständig
- silikon-, cadmium- und halogenfrei

## PROPERTIES

- resistant against oil and benzine
- widely resistant to acids and solvents
- free of silicone, cadmium, halogen

🔥 IP 68 | IP 69K  
🌡️ -40°C ... +120°C

EN / IEC 61386-23

UL 1696 | CSA 22.2  
UR file E86359

EN 45545-2 [HL 2]

ASTM E162 | E662  
SMP 800-C

VDI 3601 / GGVS EB

UV REACH RoHS



FLEXA No.	FLEXA No.	AD							kg/100	St.
schwarz	grau	Ø	Øl	ØB	C	E	F	ØD		pcs.
black	grey		mm	mm	mm	mm	mm	mm		



VIDEO

## RQW-M

Metr. EN 60423 [IP 68 | 69K]

FLEXA No.	FLEXA No.	Price	M	l	B	C	E	F	D	kg/100	St.
1 5020 064 210	1 5020 064 010	10,0	M 10 x 1,0	6,0	17,0	12,0	33,5	34,5	16,0	0,600	50
1 5020 064 212	1 5020 064 012	13,0	M 12 x 1,5	8,0	20,0	10,0	36,0	34,0	20,0	0,760	50
1 5020 036 216	1 5020 036 016	13,0	M 16 x 1,5	12,0	20,0	12,0	36,0	36,5	20,0	0,720	50
1 5020 064 216	1 5020 064 016	15,8	M 16 x 1,5	12,0	23,0	12,0	42,0	40,5	24,5	1,080	50
1 5020 036 220	1 5020 036 020	15,8	M 20 x 1,5	15,5	23,0	13,0	42,0	41,5	24,5	1,060	50
1 5020 064 220	1 5020 064 020	21,2	M 20 x 1,5	14,8	29,5	13,0	50,0	49,0	27,0	2,000	50
1 5020 036 225	1 5020 036 025	21,2	M 25 x 1,5	18,0	29,5	13,0	50,0	49,0	29,5	1,940	50
1 5020 064 225	1 5020 064 025	28,5	M 25 x 1,5	19,0	37,0	13,0	57,0	57,0	34,0	3,120	25
1 5020 036 232	1 5020 036 032	28,5	M 32 x 1,5	24,0	37,0	15,0	57,0	59,0	37,0	3,040	25
1 5020 064 232	1 5020 064 032	34,5	M 32 x 1,5	24,0	44,0	15,0	67,5	65,0	43,0	4,800	10
1 5020 036 240	1 5020 036 040	34,5	M 40 x 1,5	32,0	44,0	15,0	67,5	67,0	45,0	4,400	10
1 5020 064 240	1 5020 064 040	42,5	M 40 x 1,5	32,0	52,0	15,0	83,0	72,0	51,5	7,000	10
1 5020 036 250	1 5020 036 050	42,5	M 50 x 1,5	39,0	52,0	15,5	83,0	74,5	55,0	7,300	10
1 5020 064 250	1 5020 064 050	54,5	M 50 x 1,5	39,0	64,0	15,0	94,0	84,0	64,0	11,400	5
1 5020 036 263	1 5020 036 063	54,5	M 63 x 1,5	53,0	64,0	16,0	94,0	85,5	68,0	10,800	5

## RQW-P

PG DIN 40430 [IP 68 | 69K]

FLEXA No.	FLEXA No.	Price	PG	l	B	C	E	F	D	kg/100	St.
1 5020 028 207	1 5020 028 007	10,0	7	7,0	17,0	9,5	34,0	33,0	16,0	0,560	50
1 5020 028 209	1 5020 028 009	13,0	9	12,0	20,0	10,0	37,0	34,0	20,0	0,680	50
1 5020 029 211		13,0	11	14,0	20,0	10,0	39,0	34,0	23,0	0,780	50
1 5020 029 213		13,0	13,5	15,5	20,0	10,0	41,0	35,0	25,0	0,860	50
1 5020 028 211	1 5020 028 011	15,8	11	14,5	23,0	10,0	42,0	37,5	24,5	1,000	50
1 5020 028 213	1 5020 028 013	18,5	13,5	13,5	26,5	13,0	46,0	47,0	27,0	1,400	50
1 5020 028 216	1 5020 028 016	21,2	16	18,0	29,5	13,0	50,0	49,0	27,0	1,800	50
1 5020 028 221	1 5020 028 021	28,5	21	24,0	37,0	13,0	58,0	57,0	34,0	2,840	25
1 5020 028 229	1 5020 028 029	34,5	29	32,0	44,0	15,0	67,5	65,0	43,0	4,200	10
1 5020 028 236	1 5020 028 036	42,5	36	39,5	52,0	15,0	83,0	72,0	51,5	7,200	10
1 5020 028 248	1 5020 028 048	54,5	48	48,5	64,0	16,0	96,0	84,0	65,0	10,200	5

## RQW-C

CTG Whitworth JIS B 0204 DIN ISO 228-1 [IP 68 | 69K]

FLEXA No.	Price	CTG	Whitworth	M	l	B	C	E	F	D	kg/100	St.
1 5020 053 201	13,0	G 16	1/2"	15,0	20,0	14,0	40,0	40,0	27,0	0,980	50	
1 5020 053 202	15,8	G 16	1/2"	15,0	23,0	14,0	42,0	43,0	27,0	1,120	50	
1 5020 053 203	21,2	G 16	1/2"	15,0	29,5	14,0	51,0	49,0	27,0	2,000	50	
1 5020 053 204	28,5	G 22	3/4"	20,5	37,0	13,0	57,0	57,0	34,0	3,000	25	
1 5020 053 205	34,5	G 28	1"	25,0	44,0	16,0	67,5	66,5	43,0	4,900	10	
1 5020 053 206	42,5	G 36	1 1/4"	35,0	52,0	18,0	83,0	76,0	52,0	7,500	10	
1 5020 053 207	54,5	G 54	2"	52,0	64,0	18,0	96,0	89,5	66,0	11,100	5	

## RQW-N

NPT ANSI/ASME B1 20 1 [IP 68 | 69K]

FLEXA No.	Price	NPT	M	l	B	C	E	F	D	kg/100	St.
1 5020 057 201	10,0	1/4"	8,5	17,0	10,0	34,0	33,0	16,0	0,400	50	
1 5020 057 202	13,0	1/4"	10,0	20,0	10,5	36,0	35,0	20,0	0,600	50	
1 5020 057 204	15,8	3/8"	12,5	26,0	12,0	44,0	44,0	24,5	0,800	50	
1 5020 057 205	15,8	1/2"	14,0	23,5	12,0	42,0	40,5	23,0	1,100	50	
1 5020 057 206	21,2	1/2"	16,0	29,5	13,0	51,0	48,5	27,0	1,880	50	
1 5020 039 221	28,5	3/4"	21,0	37,0	14,0	57,5	57,0	34,0	3,040	25	
1 5020 039 228	34,5	1"	28,0	44,0	16,0	67,5	67,5	43,0	4,800	10	
1 5020 057 207	42,5	1 1/4"	35,0	52,0	18,0	83,0	76,0	52,0	6,900	10	
1 5020 057 208	42,5	1 1/2"	36,5	54,0	16,5	83,0	76,0	56,0	7,350	10	
1 5020 057 209	54,5	1 1/2"	41,0	64,0	18,0	95,0	87,0	64,5	11,800	5	
1 5020 057 210	54,5	2"	52,0	66,0	21,0	100,0	90,0	65,0	10,900	5	

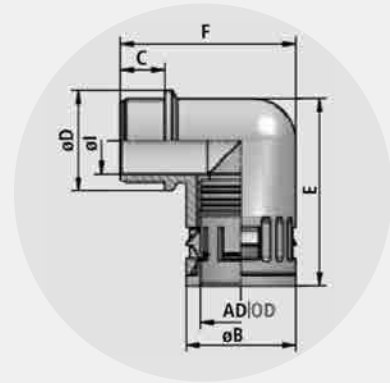

IP 66  
-40°C ... +120°C

EN / IEC 61386-23

UL 1696 | CSA 22.2  
UR file E86359

ASTM E162|E662  
SMP 800-C



VIDEO

# RQW1

Kunststoff-Schnellverschraubung  
Winkel 90°  
Außengewinde  
konisch dichtend

Plastic connector, quick-type  
elbow 90°  
outer thread  
conically sealed

## EIGENSCHAFTEN

- beständig gegen Öl und Benzin
- weitgehend säure- und lösungsmittelbeständig
- silikon-, cadmium- und halogenfrei

## PROPERTIES

- resistant against oil and benzene
- widely resistant to acids and solvents
- free of silicone, cadmium, halogen

FLEXA No.	FLEXA No.	AD OD										
schwarz black	grau grey	ø	øl mm	øB mm	C mm	E mm	F mm	øD mm	kg 100	St. pcs.		

### RQW1 – M

Metr.  
EN 60423

[IP 66]

1 5020 051 210	1 5020 051 010	10,0	M 10 x 1,0	6,0	17,0	12,0	33,5	34,5	16,0	0,570	50
1 5020 051 212	1 5020 051 012	13,0	M 12 x 1,5	8,0	20,0	10,0	36,0	34,0	20,0	0,780	50
1 5020 051 216	1 5020 051 016	13,0	M 16 x 1,5	12,0	20,0	12,0	36,0	36,5	20,0	0,720	50
1 5020 051 218	1 5020 051 018	15,8	M 16 x 1,5	12,0	23,0	12,0	42,0	40,5	24,5	1,120	50
1 5020 051 220	1 5020 051 020	15,8	M 20 x 1,5	15,5	23,0	13,0	42,0	41,5	24,5	1,100	50
1 5020 051 219	1 5020 051 019	18,5	M 20 x 1,5	13,5	26,5	13,0	46,0	47,0	27,0	1,600	50
1 5020 051 222	1 5020 051 022	21,2	M 20 x 1,5	14,8	29,5	13,0	50,0	49,0	27,0	2,020	50
1 5020 051 225	1 5020 051 025	21,2	M 25 x 1,5	18,0	29,5	13,0	50,0	49,0	29,5	1,980	50
1 5020 051 228	1 5020 051 028	28,5	M 25 x 1,5	18,0	37,0	13,0	57,0	57,0	34,0	3,080	25
1 5020 051 232	1 5020 051 032	28,5	M 32 x 1,5	24,0	37,0	15,0	57,0	59,0	37,0	3,040	25
1 5020 051 234	1 5020 051 034	34,5	M 32 x 1,5	24,0	44,0	15,0	67,5	65,0	43,0	4,900	10
1 5020 051 240	1 5020 051 040	34,5	M 40 x 1,5	32,0	44,5	15,0	67,5	67,0	45,0	4,400	10
1 5020 051 242	1 5020 051 042	42,5	M 40 x 1,5	33,0	52,0	15,0	81,0	72,0	51,5	7,300	10
1 5020 051 250	1 5020 051 050	42,5	M 50 x 1,5	39,0	52,0	15,5	83,0	74,5	55,0	7,300	10
1 5020 051 254	1 5020 051 054	54,5	M 50 x 1,5	39,0	64,0	15,0	94,0	84,0	64,0	12,100	5
1 5020 051 263	1 5020 051 063	54,5	M 63 x 1,5	53,0	64,0	16,0	94,0	85,5	68,0	10,600	5

Kleine Packungseinheit | small packing unit

1 5020 751 212		13,0	M 12 x 1,5	8,0	20,0	10,0	36,0	34,0	20,0	0,780	10
1 5020 751 216		13,0	M 16 x 1,5	12,0	20,0	12,0	36,0	36,5	20,0	0,720	10
1 5020 751 220		15,8	M 20 x 1,5	15,5	23,0	13,0	42,0	41,5	24,5	1,100	10
1 5020 751 225		21,2	M 25 x 1,5	18,0	29,5	13,0	50,0	49,0	29,5	1,980	10
1 5020 751 232		28,5	M 32 x 1,5	24,0	37,0	15,0	57,0	59,0	37,0	3,040	10
1 5020 751 240		34,5	M 40 x 1,5	32,0	44,0	15,0	67,5	67,0	45,0	4,400	2
1 5020 751 250		42,5	M 50 x 1,5	39,0	52,0	15,5	83,0	74,5	55,0	7,300	2
1 5020 751 263		54,5	M 63 x 1,5	53,0	64,0	16,0	94,0	85,5	68,0	10,600	2

### RQW1 – P

PG  
DIN 40430

[IP 66]

1 5020 050 207	1 5020 050 007	10,0	7	7,0	17,0	10,0	34,0	33,0	16,0	0,560	50
1 5020 050 209	1 5020 050 009	13,0	9	12,0	20,0	10,0	37,0	34,0	20,0	0,700	50
1 5020 050 211	1 5020 050 011	15,8	11	15,5	23,0	10,0	42,0	37,5	24,5	1,040	50
1 5020 050 213	1 5020 050 013	18,5	13,5	13,5	26,5	13,0	46,0	47,0	27,0	1,400	50
1 5020 050 216	1 5020 050 016	21,2	16	18,0	29,5	13,0	50,0	48,0	27,0	1,860	50
1 5020 050 221	1 5020 050 021	28,5	21	24,0	37,0	13,0	58,0	56,0	34,0	2,800	25
1 5020 050 229	1 5020 050 029	34,5	29	32,0	44,0	15,0	67,5	65,0	43,0	4,200	10
1 5020 050 236	1 5020 050 036	42,5	36	36,5	52,0	15,0	83,0	72,0	51,5	7,200	10
1 5020 050 248	1 5020 050 048	54,5	48	48,5	64,0	16,0	96,0	84,0	65,0	10,200	5

### RQW1 – N

NPT  
ANSI/ASME B1.20.1

[IP 66]

1 5727 015 205		15,8	1/2"	16,0	26,0	11,0	42,0	40,5	26,0	1,100	50
1 5727 021 205		21,2	1/2"	16,0	29,5	13,0	51,0	48,5	27,0	1,600	50
1 5727 028 214		28,5	3/4"	21,0	37,0	14,0	57,5	57,0	34,0	3,000	25
1 5727 034 210		34,5	1"	28,0	44,0	16,0	67,5	66,0	43,0	4,650	10
1 5727 042 217		42,5	1 1/4"	35,0	52,0	18,0	83,0	76,0	52,0	5,100	10
1 5727 054 209		54,5	1 1/2"	41,0	64,0	18,0	95,0	87,0	64,5	11,870	5

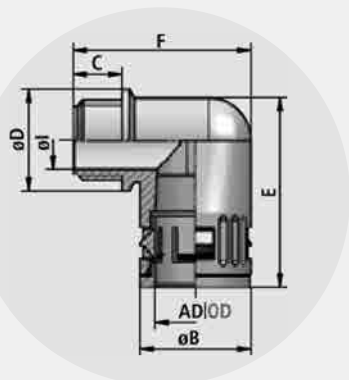

# RQW-F

Kunststoff-Schnellverschraubung  
Winkel 90°, Flanschanschluss  
inkl. Flanschdichtung

Plastic connector, quick-type  
elbow flange 90°  
incl. flange-sealing

## EIGENSCHAFTEN

- beständig gegen Öl und Benzin
- weitgehend säure- und lösungsmittelbeständig
- silikon-, cadmium- und halogenfrei

## PROPERTIES

- resistant against oil and benzine
- widely resistant to acids and solvents
- free of silicone, cadmium, halogen

IP 68  
-40°C ... +120°C

ASTM E162|E662  
SMP 800-C



VIDEO

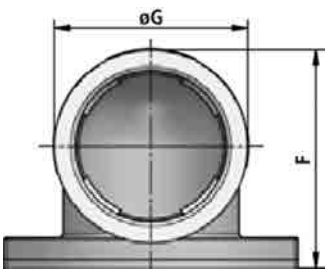
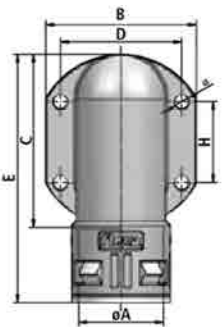

FLEXA No.	FLEXA No.	AD												kg 100	St.
schwarz	grau	ø	øA	B	C	D	H	ø	øG	F	E			pcs.	
black	grey	mm	mm	mm	mm	mm	mm	mm	mm	mm	mm				

RQW-F														[IP 68]
1 5020 077 216	1 5020 077 016	21,2	20,0	46,0	42,0	36,0	-	5,5	29,5	36,0	85,0	2,100	10	
1 5020 077 221	1 5020 077 021	28,5	27,0	65,5	61,0	53,0	-	6,6	37,0	45,0	88,0	4,200	10	
1 5020 077 229	1 5020 077 029	34,5	33,0	67,0	77,0	54,0	36,0	6,6	44,0	50,0	110,0	6,500	10	
1 5020 077 236	1 5020 077 036	42,5	38,0	85,0	84,5	73,0	30,0	6,6	52,0	64,5	104,0	7,800	10	
1 5020 077 248	1 5020 077 048	54,5	50,0	86,0	100,0	73,0	30,0	6,6	64,0	76,0	121,0	8,900	10	

-40°C ... +120°C

ASTM E162|E662  
SMP 800-C



## RQF2-M

Kunststoff-Flansch  
passend für alle metrischen  
Verschraubungen mit  
Außengewinde nach EN 60423

Plastic flange  
suitable for all metric connectors  
with outer thread acc. to EN 60423

### EIGENSCHAFTEN

- beständig gegen Öl und Benzin
- weitgehend säure-/lösungsmittelbeständig
- silikon-, cadmium- und halogenfrei

### PROPERTIES

- resistant against oil and benzine
- widely resistant to acids and solvents
- free of silicone, cadmium, halogen

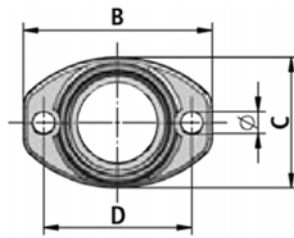

Typ | type A

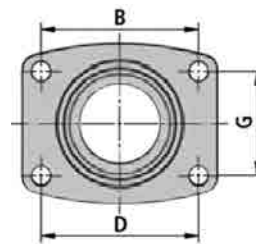

Typ | type B

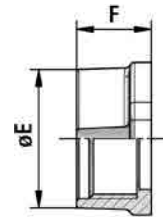

FLEXA No.

FLEXA No.

Typ  
type



schwarz  
black

grau  
grey

B C D G ø øE H F  
mm mm mm mm mm mm mm mm

kg|100

St.  
pcs.

### RQF2-M

Metr.  
EN 60423

[IP 68]

1 5020 071 225	1 5020 071 025	A	M 25 x 1,5	46	32	36	-	5,4	29,5	13,0	15,5	0,660	50
1 5020 071 232	1 5020 071 032	A	M 32 x 1,5	63	46	52	-	6,6	37,0	16,5	20,0	1,480	25
1 5020 071 240	1 5020 071 040	B	M 40 x 1,5	67	55	54	36	6,6	45,0	16,0	18,5	1,900	10
1 5020 071 250	1 5020 071 050	B	M 50 x 1,5	86	64	73	30	6,6	55,0	17,0	20,0	2,500	10
1 5020 071 263	1 5020 071 063	B	M 63 x 1,5	86	70	73	30	6,6	68,0	17,0	20,0	2,500	5



# RQE

Endtülle | Übergangsstelle  
von Schlauch zu Kabel

## MATERIAL

Kunststoff [TPE]

## VERWENDUNG

- rationeller Schlauchendenabschluss
- durch einfaches Aufstecken montiert

End cap | transition  
from tubing to cable

## MATERIAL

plastics [TPE]

## APPLICATION

- rational tubing end
- assembled by just putting on

-40°C ... +120°C

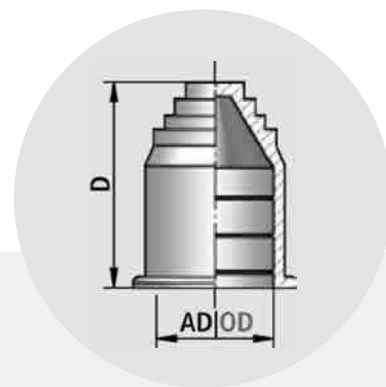

FLEXA No.

FLEXA No.

AD  
OD



min  $\varnothing$  – max  $\varnothing$   
mm



kg|100



St.  
pcs.

schwarz  
black

grau  
grey

$\varnothing$

D  
mm

## RQE

1 5030 012 207	1 5030 012 007	10,0	1,0 - 8,0	29,0	0,120	50
1 5030 012 209	1 5030 012 009	13,0	1,0 - 10,0	29,0	0,220	50
1 5030 012 211	1 5030 012 011	15,8	4,0 - 12,0	36,0	0,320	50
1 5030 012 213	1 5030 012 013	18,5	4,0 - 13,0	37,5	0,520	50
1 5030 012 216	1 5030 012 016	21,2	6,0 - 16,5	37,0	0,560	50
1 5030 012 221	1 5030 012 021	28,5	6,0 - 23,0	40,0	0,650	25
1 5030 012 229	1 5030 012 029	34,5	6,0 - 29,0	44,0	0,960	25
1 5030 012 236	1 5030 012 036	42,5	10,0 - 37,0	46,0	1,480	25
1 5030 012 248	1 5030 012 048	54,5	10,0 - 47,0	53,0	2,100	10

🌡️ -40°C ... +120°C

ASTM E162|E662  
SMP 800-C



# RQA

Endtülle  
V0 nach UL 94

**MATERIAL**  
Kunststoff [PA]

**VERWENDUNG**

- zum Schutz des Kabels
- aufsteckbar auf alle ROHRflex®-Schläuche



Terminal sleeve  
V0 acc. to UL 94

**MATERIAL**  
plastics [PA]

**APPLICATION**

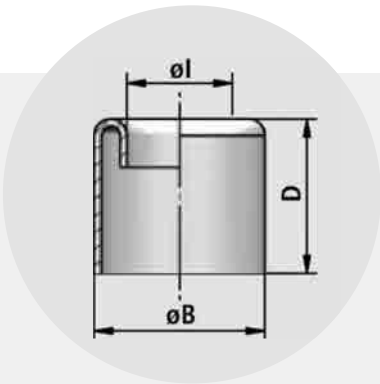
- for cable protection
- attachable on all ROHRflex®-tubings



FLEXA No.	FLEXA No.	AD OD	øl	øB	D	 kg 100	 St. pcs.
schwarz black	grau grey	ø	mm	mm	mm		
1 5030 021 207	1 5030 021 007	10,0	4,3	12,0	20,0	0,104	50
1 5030 021 209	1 5030 021 009	13,0	7,8	15,0	20,0	0,140	50
1 5030 021 211	1 5030 021 011	15,8	10,3	18,5	20,0	0,160	50
1 5030 021 213	1 5030 021 013	18,5	12,1	20,5	21,0	0,240	50
1 5030 021 216	1 5030 021 016	21,2	14,3	24,0	21,0	0,220	50
1 5030 021 221	1 5030 021 021	28,5	20,8	31,0	22,0	0,320	25
1 5030 021 229	1 5030 021 029	34,5	26,8	36,8	22,0	0,400	25
1 5030 021 236	1 5030 021 036	42,5	33,8	44,5	25,0	0,640	25
1 5030 021 248	1 5030 021 048	54,5	45,8	56,5	25,0	0,800	10

# RQPRO

Massiver Schlauch-Scheuerschutz  
[Protektor] inkl. VA-Schrauben

Heavy abrasion protector  
incl. screws made of stainless steel

-40°C ... +120°C

**MATERIAL**  
Kunststoff [PA]

**MATERIAL**  
plastics [PA]

EN 45545-2 [HL 3]

ASTM E162|E662  
SMP 800-C



**EIGENSCHAFTEN**

- silikon-, cadmium- und halogenfrei
- selbstverlöschend
- hohe mechanische Belastbarkeit
- Schlagfestigkeit
- inkl. VA - Schrauben mit selbstsichernder Mutter

**PROPERTIES**

- free of silicone, cadmium, halogen
- self-extinguishing
- fit for high mechanical stress
- impact-resistant
- incl. stainless steel screw with self-locking nut

**ANWENDUNG**

Zum Schutz der Schlauchinstallation hauptsächlich bei extremer mechanischer Belastung im Bereich der Automatisierung und bei Schienenfahrzeugen.

**APPLICATION**

To protect the tubing installation mainly for extremely mechanical stresses by automation or railway.

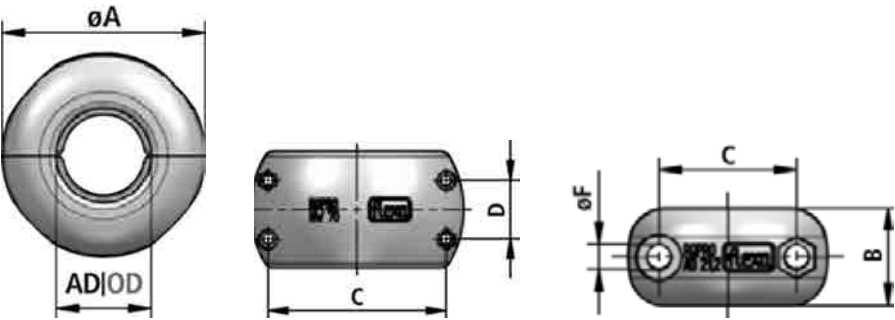

FLEXA No.	LW NW	AD OD	øA	B	C	D	øF	kg 100	St. pcs.
-----------	----------	----------	----	---	---	---	----	--------	-------------

**RQPRO**

1 5524 021 200		21,2	45,0	22,0	31,0	–	5,5	2,330	25
1 5524 028 200		28,5	52,0	26,0	39,0	–	5,5	2,900	25
1 5524 034 200		34,5	58,0	26,0	45,0	–	5,5	3,270	10
1 5524 042 200		42,5	66,0	30,0	54,0	–	5,5	4,050	10
1 5524 054 200		54,5	77,0	30,0	65,0	–	5,5	4,900	5
1 5524 079 200	79,2		108,0	60,0	90,9	30,0	5,5	14,550	5

IP 54 ... IP 69K  
-40°C ... +120°C

UL 1696 | CSA 22.2  
UR file E86359  
ASTM E162 | E662  
SMP 800-C



## Multi-GFP

Einteiliger Flanschanschluss  
gerade  
für Kabelsammler ROHRflex® Multi

One-part flange connector  
straight  
for cable buncher ROHRflex® Multi

### EIGENSCHAFTEN

- beständig gegen viele Öle und Benzine
- weitgehend säure- und lösungsmittelbeständig
- halogen- silikon-, cadmiumfrei
- selbstverlöschend
- flammwidrig
- mit Spezialdichtungen Schutzart IP 65, IP 68, IP 69K

### PROPERTIES

- resistant against several oils and benzines
- widely resistant to acids and solvents
- free of silicone, cadmium, halogen
- self-extinguishing
- flame resistant
- for higher protective system IP 65, IP 68, IP 69K  
special sealings are available

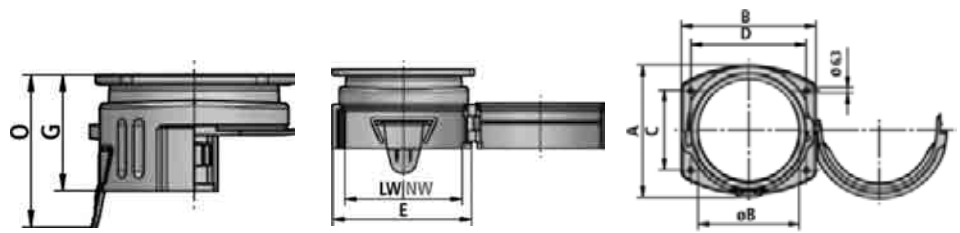

FLEXA No.	FLEXA No.	LW NW	A	B	C	D	E	G	øF	O	kg 100	St. pcs.
schwarz black	grau grey	ø	mm	mm	mm	mm	mm	mm	mm	mm		
[IP 54 ... IP 69K]												
1 5032 206 070	1 5032 006 070	70	94,0	96,0	60,5	80,5	96,4	65,5	68	88,0	10,800	1
1 5032 206 095	1 5032 006 095	95	120,0	126,0	74,0	108,0	123,0	70,5	95	92,5	16,800	1

## Multi-FRM

Spezialdichtung für Multi-Anschlusssteile  
Material Moosgummi

Special sealing for Multi connectors  
Material foam rubber

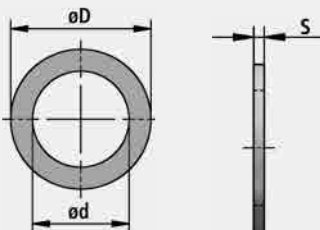

FLEXA No.	LW NW	øD mm	ød mm	s mm	kg 100	St. pcs.
[IP 65]						
1 5032 208 070	70	78,0	66,0	6,0	0,130	1
1 5032 208 095	95	105,0	89,0	6,0	0,240	1

# Multi-WFP

Einteiliger Flanschanschluss  
90° Winkel  
für Kabelsammler ROHRflex® Multi

One-part flange connector  
90° elbow  
for cable buncher ROHRflex® Multi

🔥 IP 54 ... IP 69K  
🌡️ -40°C ... +120°C

UL 1696 | CSA 22.2  
UR file E86359  
ASTM E162|E662  
SMP 800-C



## EIGENSCHAFTEN

- beständig gegen viele Öle und Benzine
- weitgehend säure- und lösungsmittelbeständig
- halogen- silikon-, cadmiumfrei
- selbstverlöschend
- flammwidrig
- mit Spezialdichtungen Schutzart IP 65, IP 68, IP 69K

## PROPERTIES

- resistant against several oils and benzene
- widely resistant to acids and solvents
- free of silicone, cadmium, halogen
- self-extinguishing
- flame resistant
- for higher protective system IP 65, IP 68, IP 69K  
special sealings are available

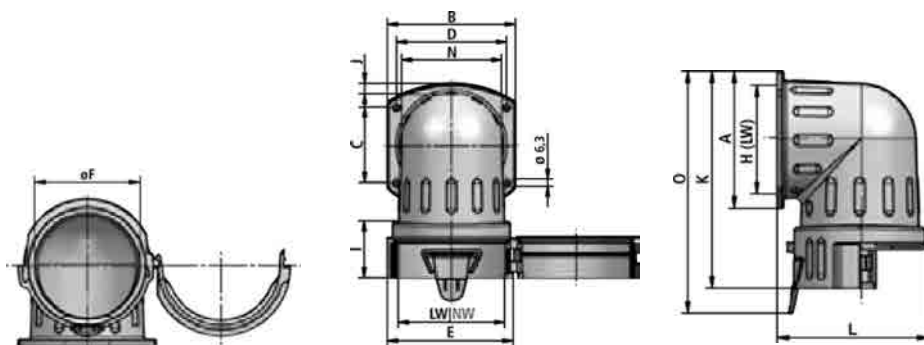

FLEXA No.	FLEXA No.	LW NW															
schwarz black	grau grey	ø	A	B	C	D	E	H	K	L	N	øF	O	kg 100	St. pcs.		

### Multi-WFP [IP 54 ... IP 69K]

1 5032 207 070	1 5032 007 070	70	94	96	60,5	80,5	96,4	69	153,0	105,0	73,0	68	176,0	19,200	1
1 5032 207 095	1 5032 007 095	95	120	126	74,0	108,0	123,0	95	191,0	133,5	98,2	95	212,0	34,600	1

# Multi-FRM68

Spezialdichtung für Multi-Anschlusssteile  
Material TPE

Special sealing for Multi connectors  
Material TPE

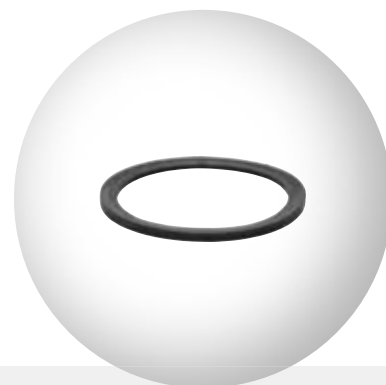

FLEXA No.	LW NW	øD mm	ød mm	s mm		
	ø				kg 100	St. pcs.

### [IP 68 | 69K]

1 5032 211 070	70	78,0	66,0	6,0	0,400	1
1 5032 211 095	95	105,0	89,0	6,0	0,730	1

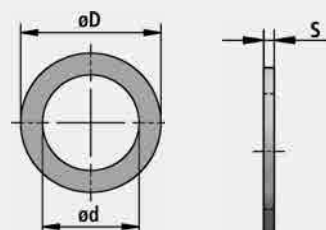

UL 1696 | CSA 22.2  
UR file E86359



EN 45545-2 [HL 3]



ASTM E162|E662  
SMP 800-C



## RQT-PA

Kunststoff-Schnellverschraubung  
T-Verteiler, hochdichtend

IP 68 | IP 69K  
-40°C ... +120°C

Plastic connector, quick-type  
T distributor, high-density

### MATERIAL

Kunststoff [PA]

### MATERIAL

plastics [PA]

### EIGENSCHAFTEN

- beständig gegen Öl und Benzin
- weitgehend säure- und lösungsmittelbeständig
- silikon-, cadmium- und halogenfrei

### PROPERTIES

- resistant against oil and benzene
- widely resistant to acids and solvents
- free of silicone, cadmium, halogen

FLEXA No.	FLEXA No.	AD 2 OD 2	AD 1/3 OD 1/3	øB 2 mm	øB 1/3 mm	E mm	D mm	øF mm	C mm	kg 100	St. pcs.
schwarz black	grau grey	ø	ø								
[IP 68   69K]											
1 5020 041 208	1 5020 041 008	15,8	2 x 15,8	23,0	23,0	54,5	80,0	2 x 5,5	20,0	2,200	10
1 5020 041 201	1 5020 041 001	21,2	2 x 21,2	29,5	29,5	66,0	93,5	2 x 6,5	27,0	4,100	10
1 5020 041 202	1 5020 041 002	28,5	2 x 28,5	37,0	37,0	78,0	107,0	2 x 6,5	34,0	5,900	10
1 5020 041 210	1 5020 041 010	34,5	2 x 28,5	44,0	37,0	77,0	113,0	2 x 6,5	38,0	6,900	10
1 5020 041 211	1 5020 041 011	34,5	2 x 34,5	44,0	44,0	90,5	119,0	2 x 6,5	40,0	8,100	10
1 5020 041 212	1 5020 041 012	42,5	2 x 42,5	52,0	52,0	94,5	138,0	2 x 6,5	45,0	11,700	10
1 5020 041 213	1 5020 041 013	54,5	2 x 54,5	64,0	64,0	105,0	146,0	2 x 6,5	56,5	15,800	5

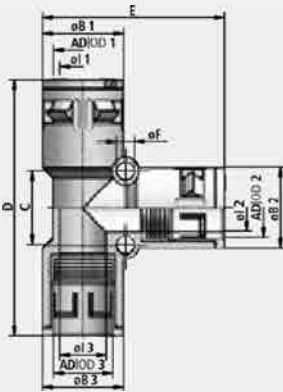

VIDEO



## RQT

Kunststoff-T-Verteiler

IP 66  
-40°C ... +120°C

One-piece plastic T distributor

### MATERIAL

Kunststoff [TPE]

### MATERIAL

plastics [TPE]

- für rationelle Schlauchmontage
- durch einfaches Aufstecken montiert

- for rational tubing assembly
- assembled by just putting on

FLEXA No.	AD 2 OD 2	AD 1/3 OD 1/3	øB 2 mm	øB 1/3 mm	E mm	D mm	øF mm	C mm	kg 100	St. pcs.	
schwarz black	ø	ø									
[IP 66]											
1 5020 067 203	10,0	2 x 10,0	17,5	17,5	32,5	46,5	2 x 4,0	18,3	0,500	10	
1 5020 067 207	13,0	2 x 13,0	21,0	21,0	36,0	51,0	2 x 4,0	21,0	0,900	10	
1 5020 067 208	15,8	2 x 15,8	25,0	25,0	44,0	63,0	2 x 4,0	24,5	1,500	10	
1 5020 067 213	15,8	2 x 28,5	25,5	36,5	56,0	65,0	2 x 4,0	37,0	2,900	10	
1 5020 067 205	18,5	2 x 18,5	26,5	26,5	48,5	70,5	2 x 4,0	24,3	1,700	10	
1 5020 067 201	21,2	2 x 21,2	29,5	29,5	50,0	71,0	2 x 4,0	29,5	2,000	10	
1 5020 067 209	28,5	2 x 21,2	36,5	32,0	51,0	78,0	2 x 4,0	29,5	2,700	10	
1 5020 067 202	28,5	2 x 28,5	36,5	36,5	57,5	77,0	2 x 4,0	37,0	2,900	10	
1 5020 067 211	34,5	2 x 34,5	42,5	42,5	64,0	85,0	2 x 4,0	42,0	4,200	10	

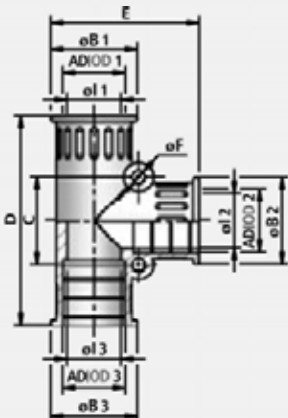

# RQY-PA

Kunststoff-Schnellverschraubung  
Y-Verteiler, hochdichtend

VO [UL 94]  
IP 68 | IP 69K  $\updownarrow$  -40°C ... +120°C

Plastic connector, quick-type  
Y distributor, high-density

UL 1696 | CSA 22.2  
UR file E86359

EN 45545-2 [HL 3]

ASTM E162|E662  
SMP 800-C

UV REACH RoHS

## MATERIAL

Kunststoff [PA]

## MATERIAL

plastics [PA]

## EIGENSCHAFTEN

- beständig gegen Öl und Benzin
- weitgehend säure- | lösungsmittelbeständig
- silikon-, cadmium- und halogenfrei

## PROPERTIES

- resistant against oil and benzine
- widely resistant to acids and solvents
- free of silicone, cadmium, halogen



FLEXA No.	FLEXA No.	AD 1	AD 2												
schwarz	grau	OD 1	OD 2	Type	ø	ø	øB 1	øB 2	D	C	øF	øF1	E	kg 100	St.
black	grey				mm	mm	mm	mm	mm	mm	mm	mm	mm		pcs.

## RQY-PA

[IP 68 | IP 69K]

1 5020 032 201	1 5020 032 001	A	13,0	2 x 10,0	20,0	17,0	69,0	36,0	2 x 5,5	1 x 4,5	23,5	1,600	10
1 5020 032 202	1 5020 032 002	A	13,0	2 x 13,0	20,0	20,0	70,5	42,0	2 x 5,5	1 x 4,5	23,5	1,800	10
1 5020 032 203	1 5020 032 003	A	15,8	2 x 13,0	23,0	20,0	71,0	42,0	2 x 5,5	1 x 4,5	29,0	2,000	10
1 5020 032 204	1 5020 032 004	A	15,8	2 x 15,8	23,0	23,0	80,0	48,0	2 x 5,5	1 x 4,5	29,0	2,200	10
1 5020 032 206	1 5020 032 006	B	21,2	2 x 15,8	29,5	23,0	87,5	49,0	2 x 6,5	-	27,0	3,300	10
1 5020 032 208	1 5020 032 008	B	28,5	2 x 21,2	37,0	29,5	100,0	62,5	2 x 6,5	-	37,0	5,500	10
1 5020 032 209	1 5020 032 009	B	34,5	2 x 28,5	44,0	37,0	106,0	77,5	2 x 6,5	-	43,0	7,700	10
1 5020 032 210	1 5020 032 010	B	42,5	2 x 34,5	52,0	44,0	125,0	98,0	2 x 6,5	-	45,0	11,700	10
1 5020 032 211	1 5020 032 011	B	54,5	2 x 42,5	64,0	52,0	129,5	110,0	2 x 6,5	-	62,0	15,500	5

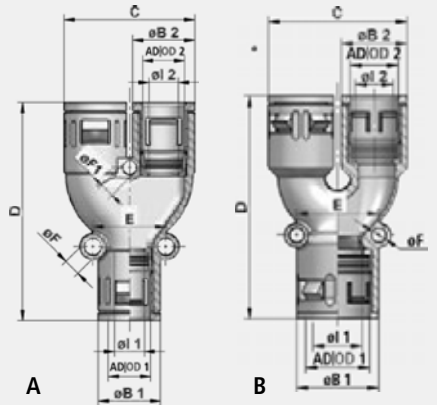

# RQY

Kunststoff-Y-Verteiler, einteilig

One-piece Plastic Y distributor

IP 66  
 $\updownarrow$  -40°C ... +120°C

UV REACH RoHS PG

## MATERIAL

Kunststoff [TPE]

## MATERIAL

plastics [TPE]

- für rationelle Schlauchmontage
- durch einfaches Aufstecken montiert

- for rational tubing assembly
- assembled by just putting on



FLEXA No.	FLEXA No.	AD 1	AD 2										
schwarz	grau	OD 1	OD 2	ø	ø	øB 1	øB 2	D	C	øF	øF	kg 100	St.
black	grey			mm	mm	mm	mm	mm	mm	mm	mm		pcs.

## RQY

[IP 66]

1 5020 033 205	1 5020 033 005	10,0	2 x 10,0	17,5	17,5	54,5	36,5	1 x 4,0	0,630	10
1 5020 033 206	1 5020 033 006	21,2	2 x 15,8	29,5	25,0	75,0	52,0	1 x 4,0	2,600	10
1 5020 033 213		28,5	2 x 15,8	36,5	25,0	75,0	52,0	1 x 4,0	2,800	10
1 5020 033 212		18,5	2 x 18,5	26,5	26,5	81,0	54,5	1 x 4,0	2,200	10
1 5020 033 207	1 5020 033 007	21,2	2 x 21,2	29,5	29,5	82,5	62,5	1 x 4,0	2,900	10
1 5020 033 208	1 5020 033 008	28,5	2 x 21,2	36,5	29,5	81,5	61,5	1 x 4,0	3,500	10
1 5020 033 209	1 5020 033 009	34,5	2 x 28,5	42,5	36,5	86,0	79,0	1 x 4,0	5,200	10
1 5020 033 210		42,5	2 x 34,5	52,5	42,5	98,5	89,0	1 x 4,0	6,500	10
1 5020 033 211		54,5	2 x 42,5	65,0	52,5	116,0	109,5	1 x 4,0	11,600	5

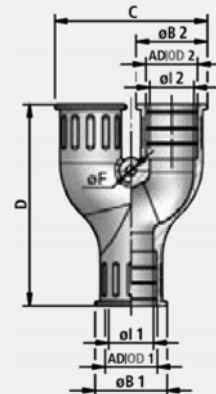

UL 1696 | CSA 22.2  
UR file E86359



EN 45545-2 [HL 3]



ASTM E162|E662  
SMP 800-C



## RQK-PA

Kunststoff-Schnellverschraubung  
Kupplung  
hochdichtend

IP 68 | IP 69K  
-40°C ... +120°C

Plastic connector, quick-type  
coupler  
high-density

### MATERIAL

Kunststoff [PA]

### MATERIAL

plastics [PA]

### EIGENSCHAFTEN

- beständig gegen Öl und Benzin
- weitgehend säure- und lösungsmittelbeständig
- silikon-, cadmium- und halogenfrei

### PROPERTIES

- resistant against oil and benzene
- widely resistant to acids and solvents
- free of silicone, cadmium, halogen

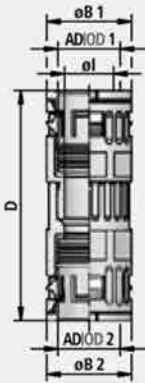

### FLEXA No.

AD 1  
OD 1

AD 2  
OD 2



schwarz  
black

ø

ø

øB 1  
mm

øB 2  
mm

øl  
mm

D  
mm

kg|100

St.  
pcs.

### RQK-PA

[IP 68|69K]

FLEXA No.	AD 1 OD 1	AD 2 OD 2	øB 1 mm	øB 2 mm	øl mm	D mm	kg 100	St. pcs.
1 5602 021 221	21,2	21,2	29,5	29,5	17,0	80,0	2,600	10
1 5602 028 228	28,5	28,5	37,0	37,0	23,5	86,5	3,500	10
1 5602 034 234	34,5	34,5	44,0	44,0	30,0	91,5	4,700	10
1 5602 042 242	42,5	42,5	52,0	52,0	36,5	145,5	11,200	10
1 5602 054 254	54,5	54,5	64,0	64,0	47,0	172,5	19,900	10



VIDEO



## RQK

Kunststoff-Kupplung

IP 66  
-40°C ... +120°C

One piece plastic Coupler

### MATERIAL

Kunststoff [TPE]

### MATERIAL

plastics [TPE]

- für rationelle Schlauchmontage
- durch einfaches Aufstecken montiert

- for efficient tubing assembly
- assembled by just putting on

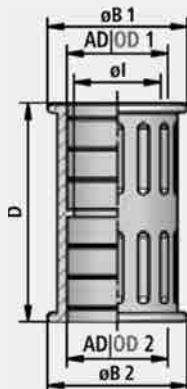

### FLEXA No.

AD 1  
OD 1

AD 2  
OD 2



schwarz  
black

ø

ø

øB 1  
mm

øB 2  
mm

D  
mm

kg|100

St.  
pcs.

### RQK

[IP 66]

FLEXA No.	AD 1 OD 1	AD 2 OD 2	øB 1 mm	øB 2 mm	D mm	kg 100	St. pcs.
1 5020 066 210	10,0	10,0	17,5	17,5	33,5	0,300	10
1 5020 066 207	13,0	13,0	20,0	20,0	36,5	0,370	10
1 5020 066 208	15,8	15,8	23,0	23,0	44,5	0,500	10
1 5020 066 209	18,5	18,5	26,5	26,5	48,0	0,800	10
1 5020 066 201	21,2	21,2	29,5	29,5	46,0	0,800	10
1 5020 066 202	28,5	28,5	36,5	36,5	46,0	1,100	10
1 5020 066 203	34,5	34,5	45,0	45,0	48,0	2,000	10
1 5020 066 204	42,5	42,5	55,0	55,0	60,0	4,000	10
1 5020 066 205	54,5	54,5	67,5	67,5	70,0	6,100	10



# RQK-GW-PA

Reparaturmuffe  
zweiteilig, bestehend aus zwei Halb-  
schalen, die nachträglich durch Schraubung  
verbunden und geschlossen werden

Repair sleeve  
two-pieces, consists of two half shells with  
integrated TPE-sealing, which can be fixed  
retrofit with self-locking screws

VO [UL 94]  
IP 68 | IP 69K  
-40°C ... +120°C

## MATERIAL

Gehäuse Kunststoff [PA]  
Dichtung TPE

## MATERIAL

Body plastics [PA]  
Sealing TPE

EN 45545-2 [HL 3]     
 ASTM E162|E662   
 SMP 800-C   
  

## EIGENSCHAFTEN

- nachträgliche Installation und Reparaturen an bestehenden Schlauchsystemen für grob und feinprofiligen Wellschlauch möglich
- einfache Montage und Demontage mit selbstsichernden Edelstahlschrauben
- silikon-, cadmium- und halogenfrei
- selbstverlöschend
- hohe mechanische Belastbarkeit
- Schlagfestigkeit
- speziell für statische und dynamische Verlegung in und an Schienenfahrzeugen

## PROPERTIES

- Retrofit installation and repair of existing protective conduit systems for fine and coarse profile
- simple mounting and dismantling with self-locking screws
- free of silicone, cadmium, halogen
- self-extinguishing
- fit for high mechanical stress
- impact-resistant
- especially for static and dynamic applications indoor and outdoor of railway cars



VIDEO

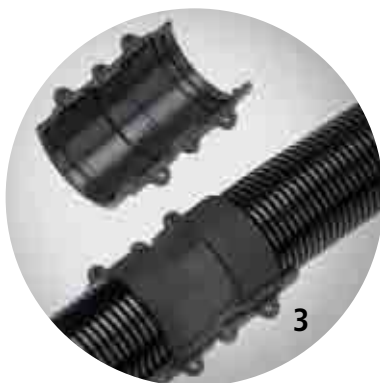
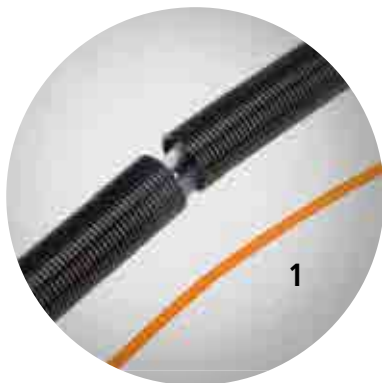

FLEXA No.

AD1  
OD1

AD2  
OD2

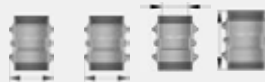

øB1  
mm

øB2  
mm

øl  
mm

D  
mm



kg|100



St.  
pcs.

schwarz  
black

## RQK-GW-PA

[IP 68 | IP 69K]

1 5609 042 242	42,5	42,5	71,0	71,0	33,0	80 0	10,000	1
1 5609 054 254	54,5	54,5	82,0	82,0	47,0	100,0	14,200	1

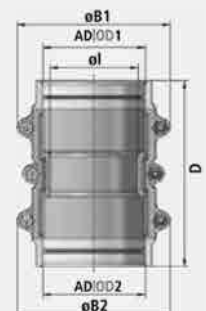

IP 68 | IP 69K  
-40°C ... +120°C

UL 1696 | CSA 22.2  
UR file E86359

EN 45545-2 [HL 3]

ASTM E162 | E662  
SMP 800-C



VIDEO

# RQGR

Kunststoff-Schnellverschraubung  
Reduzierung  
hochdichtend

Plastic connector, quick-type  
reducer  
high-density

## MATERIAL

Kunststoff [PA]

## MATERIAL

plastics [PA]

## EIGENSCHAFTEN

- beständig gegen Öl und Benzin
- weitgehend säure- und lösungsmittelbeständig
- silikon-, cadmium- und halogenfrei

## PROPERTIES

- resistant against oil and benzine
- widely resistant to acids and solvents
- free of silicone, cadmium, halogen

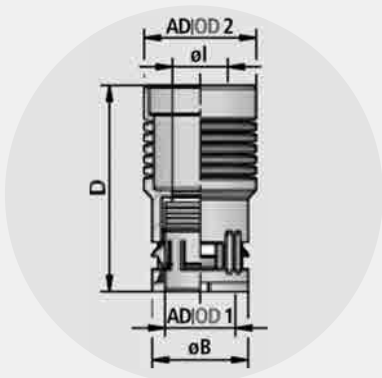

FLEXA No.	AD 1 OD 1	AD 2 OD 2					
schwarz black	ø	ø	øB mm	øl mm	D mm	kg 100	St. pcs.

RQGR	[IP 68   IP 69K]						
1 5601 010 221	10,0	21,2	17,0	8,0	58,0	0,800	10
1 5601 010 228	10,0	28,5	17,0	7,0	63,0	1,400	10
1 5601 013 215	13,0	15,8	20,0	10,0	56,0	0,900	10
1 5601 013 221	13,0	21,2	20,0	10,0	60,5	0,900	10
1 5601 013 228	13,0	28,5	20,0	10,0	62,5	1,500	10
1 5601 015 221	15,8	21,2	23,0	14,0	60,5	1,200	10
1 5601 015 228	15,8	28,5	23,0	12,5	63,0	1,600	10
1 5601 015 234	15,8	34,5	23,0	13,5	60,0	1,700	10
1 5601 021 228	21,2	28,5	29,5	17,0	65,0	2,140	10
1 5601 021 234	21,2	34,5	29,5	17,0	64,0	2,000	10
1 5601 021 242	21,2	42,5	29,5	17,0	70,5	3,600	10
1 5601 021 254	21,2	54,5	29,5	17,0	86,0	4,000	5
1 5601 028 234	28,5	34,5	37,0	23,5	70,0	3,200	10
1 5601 028 242	28,5	42,5	37,0	23,5	78,0	3,700	10
1 5601 028 254	28,5	54,5	37,0	23,5	81,5	4,200	5
1 5601 034 242	34,5	42,5	44,0	30,0	75,0	3,800	10
1 5601 034 254	34,5	54,5	44,0	30,0	83,0	4,400	5
1 5601 042 254	42,5	54,5	52,0	39,0	84,0	4,500	5

# RQH | RQHG

Schlauchhalter  
für leichte Anwendungen

-40°C ... +120°C

Tubing clamp  
for light applications

EN / IEC 61386-23



## MATERIAL

Kunststoff [PA]

## MATERIAL

plastics [PA]

## EIGENSCHAFTEN

- Rippenfixierung zur Zugentlastung
- unterschiedliche Größen aneinanderreihbar
- einsetzbar in C-Profilschienen

## PROPERTIES

- ribbed fixing for strain relief
- assembly of varying sizes joined in line
- using in combination with C-profile bar

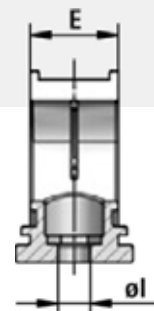
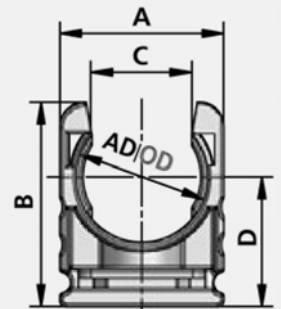

FLEXA No.	FLEXA No.	AD OD	A	B	D	E	øl	kg 100	St. pcs.
schwarz black	grau grey	ø	mm	mm	mm	mm	mm		
<b>RQH</b>	ohne Deckel	without cover							
1 5030 025 207	1 5030 025 007	10,0	19,5	19,0	13,0	15,0	5,5	0,340	50
1 5030 025 209	1 5030 025 009	13,0	19,5	22,6	14,5	15,0	5,5	0,340	50
1 5030 025 211	1 5030 025 011	15,8	21,5	25,4	16,1	15,0	5,5	0,360	50
1 5030 025 213	1 5030 025 013	18,5	24,5	29,0	18,0	15,0	5,5	0,500	50
1 5030 025 216	1 5030 025 016	21,2	26,5	33,0	21,0	15,0	6,5	0,540	50
1 5030 025 221	1 5030 025 021	28,5	34,7	39,4	22,7	15,0	6,5	0,760	25
1 5030 025 229	1 5030 025 029	34,5	40,0	44,4	26,0	15,0	6,5	0,880	25
1 5030 025 236	1 5030 025 036	42,5	54,0	55,5	30,0	20,0	6,5	2,000	25
1 5030 025 248	1 5030 025 048	54,5	67,0	69,0	39,0	17,0	6,5	2,600	10
<b>RQHG</b>	mit Deckel	with cover							
1 5030 028 207	1 5030 028 007	10,0	19,5	19,0	13,0	15,0	5,5	0,400	50
1 5030 028 209	1 5030 028 009	13,0	19,5	22,6	14,5	15,0	5,5	0,420	50
1 5030 028 211	1 5030 028 011	15,8	21,5	25,4	16,1	15,0	5,5	0,460	50
1 5030 028 213	1 5030 028 013	18,5	24,5	29,0	18,0	15,0	5,5	0,580	50
1 5030 028 216	1 5030 028 016	21,2	26,5	33,0	21,0	15,0	6,5	0,660	50
1 5030 028 221	1 5030 028 021	28,5	34,7	39,4	22,7	15,0	6,5	0,920	25
1 5030 028 229	1 5030 028 029	34,5	40,0	44,4	26,0	15,0	6,5	1,080	25
1 5030 028 236	1 5030 028 036	42,5	54,0	55,5	30,0	20,0	6,5	2,364	25
1 5030 028 248	1 5030 028 048	54,5	67,0	69,0	39,0	17,0	6,5	3,200	10

# RQHD | RQHV

Deckel RQH | Verbindungssteg RQHV  
für Schlauchhalter RQH

-40°C ... +120°C

Cover | Connecting element RQHV  
for tubing clamp RQH

## MATERIAL

Kunststoff [PA]

## MATERIAL

plastics [PA]

FLEXA No.	FLEXA No.	AD OD	kg 100	St. pcs.
schwarz black	grau grey	ø		
<b>RQHD</b>				
1 5030 026 207	1 5030 026 007	10,0	0,060	50
1 5030 026 209	1 5030 026 009	13,0	0,072	50
1 5030 026 211	1 5030 026 011	15,8	0,080	50
1 5030 026 213	1 5030 026 013	18,5	0,100	50
1 5030 026 216	1 5030 026 016	21,2	0,120	50
1 5030 026 221	1 5030 026 021	28,5	0,160	25
1 5030 026 229	1 5030 026 029	34,5	0,200	25
1 5030 026 236	1 5030 026 036	42,5	0,360	25
1 5030 026 248	1 5030 026 048	54,5	0,500	10
<b>RQHV</b>				
1 5030 027 201	1 5030 027 001	10,0 - 54,5	0,030	100



EN / IEC 61386-23



## RQS

Einteiliger Schlauchhalter  
für mittlere und schwere Anwendungen

### MATERIAL

Kunststoff [PA]

### EIGENSCHAFTEN

- Rippenfixierung zur Zugentlastung
- durch Filmscharnier angebundener Deckel zur schnellen Montage
- auch unterschiedliche Größen sind aneinanderreihbar
- einsetzbar in C-Profilschienen
- silikon-, cadmium- und halogenfrei
- hohe mechanische Belastbarkeit
- Schlagfestigkeit

🔥 -40°C ... +120°C

One-piece tubing clamp  
for medium and heavy duty applications

### MATERIAL

plastics [PA]

### PROPERTIES

- ribbed fixing for strain relief
- quick assembly by means of a film hinge
- assembly of varying sized joined in line
- for using in combination with C-profile bar
- free of silicone, cadmium, halogen
- fit for high mechanical stress
- impact-resistant

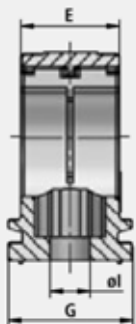
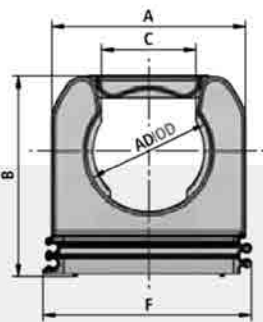

FLEXA No.	FLEXA No.	AD OD	A mm	B mm	C mm	E mm	F mm	G mm	øl mm	kg 100	St. pcs.
schwarz black	grau grey	ø									
1 5030 020 207	1 5030 020 007	10,0	21,0	23,5	8,5	16,0	23,0	20,0	5,5	0,470	50
1 5030 020 209	1 5030 020 009	13,0	25,0	25,0	9,2	16,0	27,0	20,0	5,5	0,640	50
1 5030 020 211	1 5030 020 011	15,8	27,0	27,0	11,2	16,0	29,0	20,0	6,5	0,700	50
1 5030 020 213	1 5030 020 013	18,5	31,0	31,5	12,7	16,0	32,0	20,0	6,5	0,880	50
1 5030 020 216	1 5030 020 016	21,2	33,0	34,0	16,1	16,0	35,0	20,0	6,5	0,940	50
1 5030 020 221	1 5030 020 021	28,5	40,0	40,5	20,5	16,0	42,0	20,0	6,5	1,000	25
1 5030 020 229	1 5030 020 029	34,5	46,0	46,9	25,7	16,0	48,0	20,0	6,5	1,390	25
1 5030 020 236	1 5030 020 036	42,5	55,0	55,0	30,0	16,0	57,0	20,0	6,5	1,770	25
1 5030 020 248	1 5030 020 048	54,5	65,5	69,5	38,0	17,0	69,0	20,0	6,5	2,450	10

# RQMS | RQM

Massiver Schlauchhalter  
für schwere Anwendungen

-40°C ... +120°C

Heavy tubing clamp  
for heavy duty applications

EN 45545-2 [HL 3]

ASTM E162|E662  
SMP 800-C



## MATERIAL

Kunststoff [PA]

## MATERIAL

plastics [PA]

## EIGENSCHAFTEN

- Befestigungsbohrungen
- Rippenfixierung zur Zugentlastung
- unterschiedliche Größen sind aneinanderreihbar, übereinander stapelbar (siehe passende Schrauben)
- einsetzbar in C-Profilsschiene

## PROPERTIES

- fastening bore hole
- ribbed fixing for strain relief
- assembly of varying sizes joined in line or on top of each other (see different screws)
- for using in combination with C-profile bar



RQM2



RQM3



RQM4



### FLEXA No.

AD  
OD



schwarz  
black

ø

A  
mm

B  
mm

D  
mm

E  
mm

øF  
mm

øG  
mm

H  
mm

kg|100

St.  
pcs.

### RQMS

1 5020 006 211	15,8	50,0	33,5	16,5	30,0	7,0	6,5	34,0	3,100	10
1 5020 006 216	21,2	54,0	33,5	16,5	30,0	7,0	6,5	38,0	3,200	10
1 5020 006 221	28,5	60,0	40,0	20,0	30,0	7,0	6,5	44,0	3,800	10

### RQM

1 5020 020 216	21,2	65,0	66,0	33,0	30,0	7,0	6,5	45,0	7,900	10
1 5020 020 221	28,5	65,0	66,0	33,0	30,0	7,0	6,5	45,0	7,500	10
1 5020 020 229	34,5	80,0	66,0	33,0	30,0	7,0	8,5	60,0	8,500	10
1 5020 020 236	42,5	80,0	66,0	33,0	30,0	7,0	8,5	60,0	7,600	10
1 5020 020 248	54,5	100,0	66,0	33,0	30,0	-	8,5	75,0	9,200	5

### RQM 2

1 5020 008 201	2 x 42,5	126,0	66,0	33,0	30,0	-	8,5	106,0	10,900	10
----------------	----------	-------	------	------	------	---	-----	-------	--------	----

### RQM 3

1 5020 008 205	3 x 28,5	125,0	40,0	20,0	30,0	-	6,5	45,0	6,700	10
1 5020 008 202	3 x 42,5	172,0	66,0	33,0	30,0	-	8,5	152,0	14,300	10
1 5020 008 208	3 x 54,5	209,0	66,0	33,0	30,0	-	8,5	190,0	16,000	5

### RQM 4

1 5020 008 203	4 x 42,5	218,0	66,0	33,0	30,0	-	8,5	198,0	18,100	10
1 5020 008 207	4 x 54,5	282,5	66,0	33,0	30,0	-	8,5	264,0	21,000	5

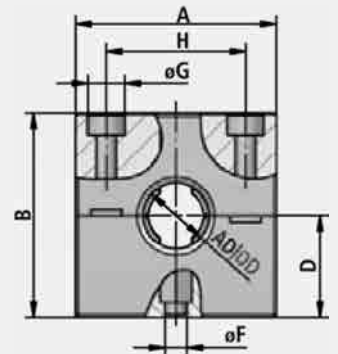

DIN 4762

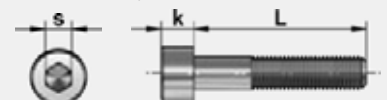

### FLEXA No. Schrauben

### FLEXA No. screws

### FLEXA No.

### Material material



Länge L

length L

k  
mm

s  
mm

St.  
pcs.

1 fach 1 time  
65 mm

2 fach 2 time\*  
130 mm

3 fach 3 time\*  
200 mm

1 0541 106 065	1 0541 106 130	1 0541 106 200	verzinkt   galvanized	M6	6	5	100
1 0541 806 065	1 0541 806 130	-	V2A   stainless steel	M6	6	5	100
1 0541 108 065	1 0541 108 130	1 0541 108 200	verzinkt   galvanized	M6	6	5	100
1 0541 808 065	1 0541 808 130	-	V2A   stainless steel	M6	6	5	100

\* stapelbar stackable

V2 [UL 94]  
 -40°C ... +120°C

EN 45545-2 [HL 3]

ASTM E162|E662  
 SMP 800-C



## RQMR

Reduzierung  
 für Schlauchhalter RQM

**MATERIAL**  
 Kunststoff [PA]

**EIGENSCHAFTEN**  
 • Rippenfixierung zur Zugentlastung

Reducer  
 for tubing clamp RQM

**MATERIAL**  
 plastics [PA]

**PROPERTIES**  
 • ribbed fixing for strain relief

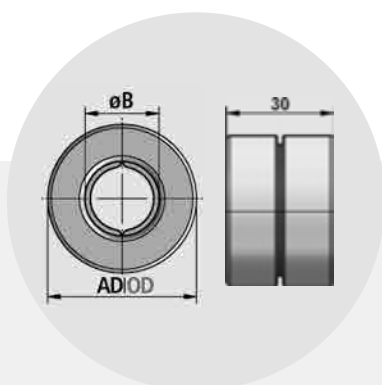

**FLEXA No.**

schwarz  
 black

**AD Halter**  
 OD holder

ø

**AD Schlauch**  
 OD conduit

øB  
 mm



kg|100



St.  
 pcs.

### RQMR

1 5605 042 215	42,5	15,8	2,100	10
1 5605 042 221	42,5	21,2	1,800	10
1 5605 042 228	42,5	28,5	1,600	10
1 5605 042 234	42,5	34,5	1,100	10
1 5605 054 228	54,5	28,5	3,500	10
1 5605 054 234	54,5	34,5	3,000	10
1 5605 054 242	54,5	42,5	2,300	10

# RQMR – Kabel

Reduzierung für Kabel  
für Schlauchhalter RQM

## MATERIAL

Kunststoff [TPE]

## EIGENSCHAFTEN

- schonende Klemmung des Kabels
- vibrationshemmend
- kombinierbar mit Schlauchhalter RQM und Schlauchscheuerschutz RQPRO

Reducer for cables for  
tubing clamp RQM

## MATERIAL

plastics [TPE]

## PROPERTIES

- gentle clamping of cables
- vibration inhibiting
- combined with tubing clamp RQM and conduit abrasion protector RQPRO

-40°C ... +120°C

EN 45545-2 [HL 3]

ASTM E162|E662  
SMP 800-C

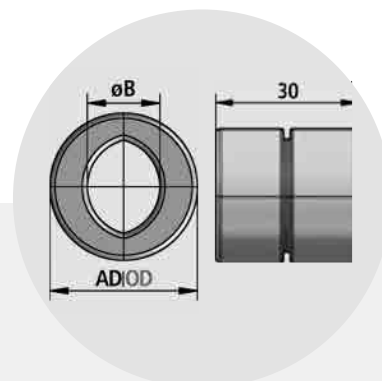

FLEXA No.	AD OD			
schwarz black	ø	B mm	kg 100	St. pcs.

## RQMR – Kabel | – Cable

1 5606 015 207	15,8	7 - 10	0,420	10
1 5606 021 210	21,2	10 - 14	0,700	10
1 5606 028 210	28,5	10 - 14	1,110	10
1 5606 028 214	28,5	14 - 18	1,000	10
1 5606 028 216	28,5	16 - 20	0,900	10
1 5606 028 219	28,5	19 - 23	0,750	10
1 5606 042 218	42,5	18 - 22	1,900	10
1 5606 042 222	42,5	22 - 26	1,800	10
1 5606 042 226	42,5	26 - 30	1,600	10
1 5606 042 230	42,5	30 - 34	1,400	10
1 5606 054 234	54,5	34 - 38	2,800	10
1 5606 054 238	54,5	38 - 42	2,400	10
1 5606 054 242	54,5	42 - 46	1,820	10

V2 [UL 94]  
 -40°C ... +120°C

EN 45545-2 [HL 3]

ASTM E162|E662  
 SMP 800-C



## RQMR–MOVE

Beweglicher Einsatz für massiven Schlauchhalter RQM mit zusätzlicher Rippenfixierung zur Zugentlastung für flexible Anwendungen

**MATERIAL**  
 Kunststoff [PA]

### EIGENSCHAFTEN

- Montage nur mit massiven Schlauchhalter RQM möglich
- rationelle Schlauchmontage für grob- und feinprofiligen Wellschlauch
- kleinstmögliche Außenmaße
- silikon-, cadmium- und halogenfrei
- selbstverlöschend
- vibrationshemmend
- hohe mechanische Belastbarkeit



Moveable inlay for heavy tubing clamp RQM with additional ribbed fixing for strain relief for flexible applications

**MATERIAL**  
 plastics [PA]

### PROPERTIES

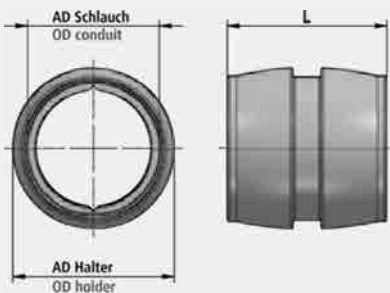
- assembly only with tubing clamp RQM
- rational tubing assembly for corrugated tubings with coarse and fine profile
- smallest outer dimensions
- free of silicone, cadmium, halogen
- self-extinguishing
- vibration resistant
- fit for high mechanical stress
- impact-resistant



FLEXA No.	AD Halter OD holder	AD Schlauch OD conduit	 kg 100	 St. pcs.
	ø mm	ø mm		
rot				
red				
<b>RQMR–MOVE</b>				
1 5607 028 234	34,5	28,5	0,760	10
1 5607 034 242	42,5	34,5	1,100	10
1 5607 042 254	54,5	42,5	1,720	10





# 04 METALLSCHUTZSCHLÄUCHE PROTECTIVE METAL CONDUITS



## PASSENDE VERSCHRAUBUNGEN APPROPRIATE CONNECTORS

									
	US-M US-P	US2-M	USDR-M	USZ-M	USZ-EX-M	USB-M	USW-M USW-P	LI-M LI-P	LIF-M LIF-P
SPR-AS	✓	✓	✓	✓	✓	✓	✓	✓	✓
SPR-VA	✓	✓	✓	✓	✓	✓	✓	✓	✓
SPR-EDU-AS	✓	✓	✓	✓	✓		✓		
SPR-CU-AS	✓	✓	✓	✓			✓		
FLEXAgraff®-AS	✓	✓	✓	✓	✓	✓	✓	✓	✓
FLEXAgraff®-VA	✓	✓	✓	✓	✓	✓	✓	✓	✓
FLEXAgraff®-CU-AS	✓	✓	✓	✓	✓		✓		



Schienefahrzeugindustrie  
Railway Technology



EMV-Anwendungen  
EMC Applications



Sensortechnik  
Sensor Technology



Ex-Bereich  
Ex-Area

**SPR – AS**

Stahl verzinkt  
S Profil  
Galvanized steel  
S profile



04.2

**SPR**

Stahl verzinkt  
S Profil  
Galvanized steel  
S profile



04.2

**SPR – VA**

Edelstahl  
S Profil  
Stainless steel  
S profile

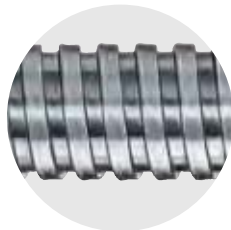

04.3

**SPR – EDU – AS**

Stahl verzinkt  
S Profil  
Stahldrahtumflechtung  
Galvanized steel  
S profile  
galvanized steel wire braiding



04.4

**SPR – CU – AS**

Stahl verzinkt  
S Profil, verzinn  
Kupferdrahtumflechtung  
Galvanized steel  
S profile  
tinned copper wire braiding



04.5

**FLEXAgraff® – AS**

Stahl verzinkt  
Agraff Profil  
Galvanized steel  
Agraff profile



04.6

**FLEXAgraff® – VA**

Edelstahl  
Agraff Profil  
Stainless steel  
Agraff profile



04.7

**FLEXAgraff® – CU – AS**

Stahl verzinkt  
Agraff Profil  
CU-Schirmgeflecht  
Galvanized steel  
Agraff profile  
CU wire braiding



04.8



IP 40  
-50°C ... +250°C

EN / IEC 61386-23



Passende Verschraubungen  
Suitable connectors

		Seite   page	
	US-M	08. 2- 4	IP 40
	US-P	08. 5- 7	
	US2-M	08. 8	IP 40
	USDR-M	08.10	IP 40
	USZ-M	08.12	IP 40
	USZ-EX-M	08.14	IP 40
	LI-M P	08.18	IP 40
	LIF-M P	08.19	IP 40
	USB-M	08.20	IP 40
	USW-M	08.22-23	IP 40
	USW-P	08.24-25	

## SPR-AS | SPR

Metall-Schutzschlauch

Protective metal conduit

**KONSTRUKTION**  
wendelgewickelt  
S-Profil

**STRUCTURE**  
strip-wound  
S profile

**MATERIAL**  
Stahl verzinkt

**MATERIAL**  
galvanized steel

### EIGENSCHAFTEN

- hochflexibel
- zugfest
- querdrukbelastbar
- DIN 49012, Bauform G, geprüft nach DIN EN IEC 61386-23 [SPR-AS]

### PROPERTIES

- highly flexible
- stretch resistant
- lateral compression resistant
- DIN 49012, structural shape G, acc. to DIN EN IEC 61386-23 [SPR-AS]

### ANWENDUNGSGEBIETE

- Maschinen- und Anlagenbau
- Fahrzeugbau
- Schienenfahrzeuge
- Schiffsbau
- Automation
- Elektroanlagen
- Ex-Bereich nach EN 1127-1

### APPLICATION

- machine and plant constructions
- automotive
- railway industry
- shipbuilding
- automation
- electrical installations
- ex-area acc. to EN 1127-1



### FLEXA No. SPR-AS

AD  
OD



	ø	mm	stat	dyn	kgj/m	m
1 1010 111 008	10	8,0 x 10,0	20	50	0,053	50
1 1010 111 011	14	11,0 x 14,0	28	70	0,119	50
1 1010 111 014	17	14,0 x 17,0	30	75	0,140	50
1 1010 111 016	19	16,0 x 19,0	35	90	0,150	50
1 1010 111 018	21	18,0 x 21,0	40	100	0,210	50
1 1010 111 023	27	23,0 x 27,0	48	120	0,260	50
1 1010 111 031	36	31,0 x 36,0	60	150	0,480	25
1 1010 111 040	45	40,0 x 45,0	82	205	0,620	25
1 1010 111 051	56	51,0 x 56,0	100	250	0,800	25

Verkaufsverpackung 10 m | 10 m sales pack

1 1011 111 008	10	8,0 x 10,0	20	50	0,053	10
1 1011 111 011	14	11,0 x 14,0	28	70	0,119	10
1 1011 111 014	17	14,0 x 17,0	30	75	0,140	10
1 1011 111 016	19	16,0 x 19,0	35	90	0,150	10
1 1011 111 018	21	18,0 x 21,0	40	100	0,210	10
1 1011 111 023	27	23,0 x 27,0	48	120	0,260	10
1 1011 111 031	36	31,0 x 36,0	60	150	0,480	10
1 1011 111 040	45	40,0 x 45,0	82	205	0,620	10**
1 1011 111 051	56	51,0 x 56,0	100	250	0,800	10**

### SPR

Sonderabmessungen | special dimensions

1 1010 101 003		3,0 x 5,0	10	25	0,037	50
1 1010 101 004		4,0 x 6,0	12	30	0,038	50
1 1010 101 005		4,8 x 7,0	19	45	0,046	50
1 1010 101 006		6,0 x 8,0	20	50	0,048	50
1 1010 101 007		7,0 x 9,0	25	65	0,052	50
1 1010 101 009		9,0 x 11,0	30	75	0,068	50
1 1010 101 010		10,0 x 13,0	32	80	0,090	50

\*\* in Ringen in rings

# SPR-VA

Metall-Schutzschlauch

Protective metal conduit

## KONSTRUKTION

wendelgewickelt  
S Profil

## STRUCTURE

strip-wound  
S profile

## MATERIAL

Edelstahl

## MATERIAL

stainless steel

## EIGENSCHAFTEN

- hochflexibel
- zugfest
- querdruckbelastbar

## PROPERTIES

- highly flexible
- stretch resistant
- lateral compression resistant

## ANWENDUNGSGEBIETE

- Maschinen- und Anlagenbau
- Fahrzeugbau
- Schienenfahrzeuge
- Schiffsbau
- Automation
- Elektroanlagen
- Sensortechnik
- Ex-Bereich nach EN 1127-1

## APPLICATION

- machine and plant constructions
- automotive
- railway industry
- shipbuilding
- automation
- electrical installations
- sensor technology
- ex-area acc. to EN 1127-1



IP 40  
-200°C ... +600°C



Passende Verschraubungen  
Suitable connectors

Seite | page

	US-M	08. 2 - 4	IP 40
	US-P	08. 5 - 7	
	US2-M	08. 8	IP 40
	USDR-M	08.10	IP 40
	USZ-M	08.12	IP 40
	USZ-EX-M	08.14	IP 40
	LI-M P	08.18	IP 40
	LIF-M P	08.19	IP 40
	USB-M	08.20	IP 40
	USB-P	08.22 - 23 08.24 - 25	

FLEXA No.

SPR-VA

AD  
OD



	ø	mm	stat	dyn	kg/m	m
1 1010 801 008	10	7,8 x 10,0	20	50	0,080	50
1 1010 801 011	14	11,0 x 14,0	28	70	0,120	50
1 1010 801 014	17	14,0 x 17,0	30	75	0,150	50
1 1010 801 016	19	16,0 x 19,0	35	90	0,185	50
1 1010 801 018	21	18,0 x 21,0	40	100	0,200	50
1 1010 801 023	27	23,0 x 27,0	48	120	0,280	50
1 1010 801 031	36	31,0 x 36,0	60	150	0,500	25
1 1010 801 040	45	40,0 x 45,0	82	205	0,620	25
1 1010 801 051	56	51,0 x 56,0	100	250	0,780	25

Verkaufsverpackung 10 m | 10 m sales pack

1 1011 801 008	10	7,8 x 10,0	20	50	0,080	10
1 1011 801 011	14	11,0 x 14,0	28	70	0,120	10
1 1011 801 014	17	14,0 x 17,0	30	75	0,150	10
1 1011 801 016	19	16,0 x 19,0	35	90	0,185	10
1 1011 801 018	21	18,0 x 21,0	40	100	0,200	10
1 1011 801 023	27	23,0 x 27,0	48	120	0,280	10
1 1011 801 031	36	31,0 x 36,0	60	150	0,500	10
1 1011 801 040	45	40,0 x 45,0	82	205	0,620	10**
1 1011 801 051	56	51,0 x 56,0	100	250	0,780	10**

Endlage | End position

1 1019 801 112		1,2 x 2,3	25	65	0,012	50
1 1019 801 115		1,5 x 2,6	25	65	0,013	50
1 1019 801 118		1,8 x 2,9	22	55	0,015	50
1 1019 801 122		2,2 x 3,4	20	50	0,016	50
1 1019 801 126		2,6 x 3,8	20	50	0,019	50
1 1018 801 003		3,0 x 5,0	10	25	0,041	50
1 1018 801 004		4,0 x 6,0	12	30	0,049	50
1 1018 801 005		5,0 x 7,0	20	50	0,043	50
1 1018 801 006		6,0 x 8,0	22	55	0,055	50
1 1018 801 007		7,0 x 9,0	25	65	0,062	50
1 1018 801 008		8,0 x 10,0	20	50	0,077	50
1 1018 801 009		9,0 x 11,0	30	75	0,092	50
1 1018 801 010		10,0 x 13,0	32	80	0,110	50

\*\* in Ringen in rings in rings





IP 40  
-50°C ... +250°C

EN / IEC 61386-23



Passende Verschraubungen  
Suitable connectors

Seite | page

	US-M	08. 2- 4	IP 40
	US-P	08. 5- 7	IP 40
	US2-M	08. 8	IP 40
	USDR-M	08.10	IP 40
	USZ-M	08.12	IP 40
	USZ-EX-M	08.14	IP 40
	USW-M	08.22-23	IP 40
	USW-P	08.24-25	IP 40

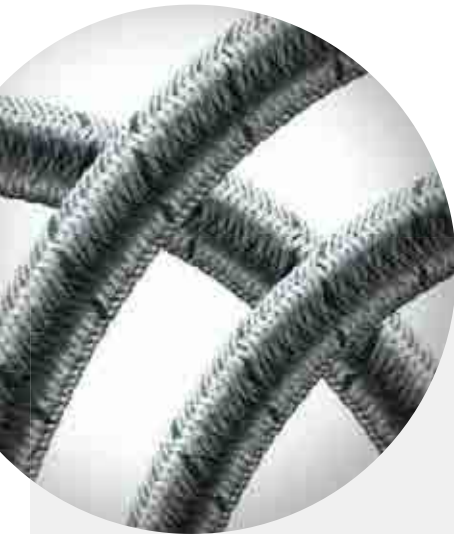

## SPR-EDU-AS

Metall-Schutzschlauch  
verzinkte Stahldrahtumflechtung

Protective metal conduit  
galvanized steel wire braiding

### KONSTRUKTION

wendelgewickelt  
S Profil  
verzinkte Stahldrahtumflechtung

### STRUCTURE

strip-wound  
S profile  
galvanized steel wire braiding

### MATERIAL

**Schlauch:** Stahl verzinkt  
**Umflechtung:** verzinkter Stahldraht

### MATERIAL

**Conduit:** galvanized steel  
**Braiding:** galvanized steel wire

### EIGENSCHAFTEN

- erhöhter, mechanischer Schutz durch hohe Zugfestigkeit
- Verdrehfestigkeit
- Biegefestigkeit
- hochflexibel
- kein Aufdrehen des Schlauches
- DIN 49012, Bauform K  
geprüft nach DIN EN IEC 61386-23

### PROPERTIES

- provides high mechanical protection due to high tensile
- torsional strength
- bending strength
- highly flexible
- no untwisting of the conduit
- DIN 49012, structural shape K acc. to DIN EN IEC 61386-23

### ANWENDUNGSGEBIETE

- Maschinen- und Anlagenbau  
Spritzgussmaschinen  
Zerspanungsmaschinen
- Fahrzeugbau
- Schiffsbau
- Automation
- Elektroanlagen
- Ex-Bereich nach EN 1127-1

### APPLICATION

- machine and plant constructions  
injection moulding  
metal cutting machines
- automotive
- shipbuilding
- automation
- electrical installations
- ex-area acc. to EN 1127-1

FLEXA No.

AD  
OD



ø

mm

stat

dyn

kg/m

m

1 4010 111 007	10	7,0 x 10,0	16	40	0,107	50
1 4010 111 010	14	10,0 x 14,0	22	55	0,170	50
1 4010 111 013	17	13,0 x 17,0	30	75	0,240	50
1 4010 111 015	19	15,0 x 19,0	32	80	0,270	50
1 4010 111 017	21	17,0 x 21,0	38	95	0,310	50
1 4010 111 022	27	22,0 x 27,0	45	115	0,430	50
1 4010 111 029	36	29,0 x 36,0	65	160	0,680	25
1 4010 111 038	45	38,0 x 45,0	80	200	0,900	25
1 4010 111 049	56	49,0 x 56,0	100	250	1,140	25

Verkaufsverpackung 10 m | 10 m sales pack

1 4011 111 007	10	7,0 x 10,0	16	40	0,107	10
1 4011 111 010	14	10,0 x 14,0	22	55	0,170	10
1 4011 111 013	17	13,0 x 17,0	30	75	0,240	10
1 4011 111 015	19	15,0 x 19,0	32	80	0,270	10
1 4011 111 017	21	17,0 x 21,0	38	95	0,310	10
1 4011 111 022	27	22,0 x 27,0	45	115	0,430	10
1 4011 111 029	36	29,0 x 36,0	65	160	0,680	10
1 4011 111 038	45	38,0 x 45,0	80	200	0,900	10**
1 4011 111 049	56	49,0 x 56,0	100	250	1,140	10**

\*\* in Ringen in rings

# SPR-CU-AS

Metall-Schutzschlauch  
CU-Umflechtung

Protective metal conduit  
CU braiding

## KONSTRUKTION

wendelgewickelt  
S Profil  
CU-Umflechtung

## STRUCTURE

strip-wound  
S profile  
CU braiding

## MATERIAL

**Schutzschlauch:** Kaltband DC 03/04  
nach EN 10139, verzinkt, Fe/Zn 3  
**Umflechtung:** Kupferdraht verzinkt

## MATERIAL

**Conduit:** cold strip DC 03/04  
acc. to EN 10139, galvanized, Fe/Zn 3  
**Braiding:** tinned copper wire

## EIGENSCHAFTEN

- hohe Zug-, Verdreh- und Biegefestigkeit
- hochflexibel
- kein Aufdrehen des Schlauches
- geprüft nach DIN EN IEC 61386-23
- Abschirmfaktor bis 30 MHz nach EN 50289-1-6 bis zu 80 dB

## PROPERTIES

- high tensile, torsional, and bending strength
- highly flexible
- no fraying of the conduit
- approved acc. to DIN EN IEC 61386-23
- screening factor up to 30 MHz acc. to EN 50289-1-6 up to 80 dB

## ANWENDUNGSGEBIETE

- Maschinen- und Anlagenbau
- Fahrzeugbau
- Schienenfahrzeuge
- Schiffsbau
- Automation
- Elektroanlagen
- EMV-Anwendungen

## APPLICATION

- machine and plant constructions
- automotive
- railway industry
- shipbuilding
- automation
- electrical installations
- emc applications

Messingdruckring zur EMV-sicheren Montage verwenden.  
EMV-Montageanleitung beachten.

Use brass thrust collar for emc-safe mounting.  
See of emc assembly instructions.



IP 40  
-50°C ... +250°C

EN / IEC 61386-23



Passende Verschraubungen  
Suitable connectors

		Seite   page	
	US-M	08. 2- 4	IP 40
	US-P	08. 5- 7	IP 40
	US2-M	08. 8	IP 40
	USDR-M	08.10	IP 40
	USZ-M	08.12	IP 40
	USW-M	08.22-23	IP 40
	USW-P	08.24-25	IP 40



FLEXA No.

AD  
OD



	ø	mm	stat	dyn	kg/m	m
1 4016 701 007	10	7,0 x 10,0	16	40	0,120	50
1 4016 701 010	14	10,0 x 14,0	22	55	0,180	50
1 4016 701 013	17	13,0 x 17,0	30	75	0,230	50
1 4016 701 017	21	17,0 x 21,0	38	95	0,350	50
1 4016 701 022	27	22,0 x 27,0	45	115	0,510	50
1 4016 701 029	36	29,0 x 36,0	65	160	0,750	25
1 4016 701 038	45	38,0 x 45,0	80	200	1,000	25
1 4016 701 049	56	49,0 x 56,0	100	250	1,350	25

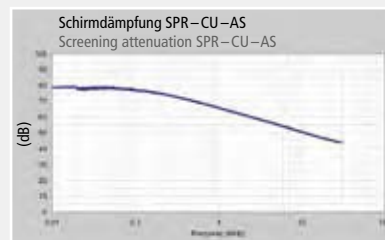



IP 40  
-50°C ... +250°C

EN / IEC 61386-23



Passende Verschraubungen  
Suitable connectors

		Seite   page	◆
	US-M	08. 2- 4	IP 40
	US-P	08. 5- 7	
	US2-M	08. 8	IP 40
	USDR-M	08.10	IP 40
	USZ-M	08.12	IP 40
	USZ-EX-M	08.14	IP 40
	LI-M P	08.18	IP 40
	LIF-M P	08.19	IP 40
	USB-M	08.20	IP 40
	USW-M	08.22-23	IP 40
	USW-P	08.24-25	



# FLEXAgraff®-AS

Metall-Schutzschlauch

Protective metal conduit

## KONSTRUKTION

wendelgewickelt  
Agraff Profil [doppelt gefalzt]  
Querschnitt rund

## STRUCTURE

strip-wound  
Agraff profile [double overlapped]  
round cross section

## MATERIAL

Kaltband DC 03/04 nach EN 10139  
verzinkt, Fe/Zn 3

## MATERIAL

cold strip DC 03/04 acc. to EN 10139  
galvanized, Fe/Zn 3

## EIGENSCHAFTEN

- hohe Zug- und Verdrehfestigkeit
- kein Aufdrehen des Schlauches
- sehr flexibel
- hoher Abschirmfaktor
- geprüft nach DIN EN IEC 61386-23

## PROPERTIES

- high tensile and twisting strength
- no untwisting of the conduit
- very flexible
- high shielding factor
- approved acc. to DIN EN IEC 61386-23

## ANWENDUNGSGEBIETE

- Maschinen- und Anlagenbau
- Fahrzeugbau
- Schienenfahrzeuge
- Schiffsbau
- Automation
- Elektroanlagen
- Ex-Bereich nach EN 1127-1

## APPLICATION

- machine and plant constructions
- automotive
- railway industry
- shipbuilding
- automation
- electrical installations
- ex-area acc. to EN 1127-1



FLEXA No.



AD  
OD

ø



mm



stat dyn



kg/m



m

1 1080 101 008	10	8,0 x 10,0	40	100	0,090	50
1 1080 101 012	14	12,0 x 14,0	50	125	0,155	50
1 1080 101 014	17	14,0 x 17,0	60	150	0,240	50
1 1080 101 016	19	16,0 x 19,0	67	170	0,290	50
1 1080 101 018	21	18,0 x 21,0	70	175	0,290	50
1 1080 101 024	27	24,0 x 27,0	90	225	0,380	50
1 1080 101 031	36	31,0 x 36,0	130	325	0,640	25
1 1080 101 040	45	40,0 x 45,0	150	375	0,840	25
1 1080 101 051	56	51,0 x 56,0	210	525	1,100	25



# FLEXAgraff® – VA

Metall-Schutzschlauch

Protective metal conduit

## KONSTRUKTION

wendelgewickelt  
Agraff Profil [doppelt gefalzt]

## STRUCTURE

strip-wound  
Agraff profile [double overlapped]

## MATERIAL

Edelstahl

## MATERIAL

stainless steel

## EIGENSCHAFTEN

- sehr flexibel
- zugfest
- querdruckbelastbar

## PROPERTIES

- very flexible
- stretch resistant
- lateral compression resistant

## ANWENDUNGSGEBIETE

- Maschinen- und Anlagenbau
- Fahrzeugbau
- Schienenfahrzeuge
- Schiffsbau
- Automation
- Elektroanlagen
- Sensortechnik
- Ex-Bereich nach EN 1127-1

## APPLICATION

- machine and plant constructions
- automotive
- railway industry
- shipbuilding
- automation
- electrical installations
- sensor technology
- ex-area acc. to EN 1127-1



IP 40  
-200°C ... +600°C

EN / IEC 61386-23



Passende Verschraubungen  
Suitable connectors

		Seite   page	●
	US-M	08. 2 - 4	IP 40
	US-P	08. 5 - 7	
	US2-M	08. 8	IP 40
	USDR-M	08.10	IP 40
	USZ-M	08.12	IP 40
	USZ-EX-M	08.14	IP 40
	LI-M P	08.18	IP 40
	LIF-M P	08.19	IP 40
	USB-M	08.20	IP 40
	USW-M	08.22 - 23	IP 40
	USW-P	08.24 - 25	

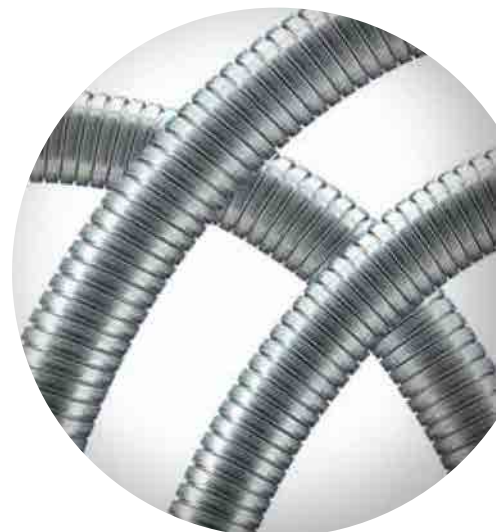

FLEXA No.

AD  
OD



	ø	mm	stat	dyn	kg/m	m
1 1080 801 004	-	4,0 x 6,0	40	100	0,055	50
1 1080 801 005	-	5,0 x 7,0	45	115	0,071	50
1 1080 801 006	-	6,0 x 8,0	25	65	0,085	50
1 1080 801 008	10	8,0 x 10,0	60	150	0,106	50
1 1080 801 010	-	10,0 x 13,0	65	160	0,290	50
1 1080 801 012	14	12,0 x 14,0	75	190	0,370	50
1 1080 801 014	17	14,0 x 17,0	60	150	0,250	50
1 1080 801 018	21	18,0 x 21,0	70	175	0,320	50
1 1080 801 024	27	24,0 x 27,0	90	225	0,430	50
1 1080 801 031	36	32,0 x 36,0	130	325	0,620	25
1 1080 801 040	45	40,0 x 45,0	150	375	0,850	25





IP 40  
-50°C ... +250°C

EN / IEC 61386-23



Passende Verschraubungen  
Suitable connectors

Seite | page

	US-M	08. 2 - 4	IP 40
	US-P	08. 5 - 7	
	US2-M	08. 8	IP 40
	USDR-M	08.10	IP 40
	USZ-M	08.12	IP 40
	USZ-EX-M	08.14	IP 40
	USW-M	08.22-23	IP 40
	USW-P	08.24-25	

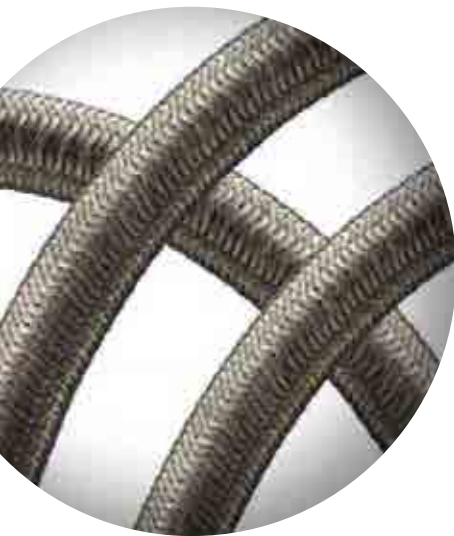

# FLEXAgraff®-CU-AS

Metall-Schutzschlauch  
CU-Umflechtung

Protective metal conduit  
CU braiding

## KONSTRUKTION

wendelgewickelt  
Agraff Profil [doppelt gefalzt]  
CU-Umflechtung

## STRUCTURE

strip-wound  
Agraff profile [double overlapped]  
CU braiding

## MATERIAL

**Schutzschlauch:** Kaltband DC 03/04  
nach EN 10139, verzinkt, Fe/Zn 3  
**Umflechtung:** Kupferdraht verzinkt

## MATERIAL

**Conduit:** cold strip DC 03/04 acc.  
to EN 10139, galvanized, Fe/Zn 3  
**Braiding:** tinned copper wire

## EIGENSCHAFTEN

- hohe Zug- und Verdrehfestigkeit
- kein Aufdrehen des Schlauches
- sehr flexibel
- geprüft nach DIN EN IEC 61386-23
- Abschirmfaktor bis 30 MHz nach EN 50289-1-6 bis zu 80 dB

## PROPERTIES

- high tensile and twisting strength
- no untwisting of the conduit
- extremely flexible
- approved acc. to DIN EN IEC 61386-23
- screening factor up to 30 MHz acc. to EN 50289-1-6 up to 80 dB

## ANWENDUNGSGEBIETE

- Maschinen- und Anlagenbau
- Fahrzeugbau
- Schienenfahrzeuge
- Schiffsbau
- Automation
- Elektroanlagen
- Sensortechnik
- EMV Anwendungen
- Ex-Bereich nach EN 1127-1

## APPLICATION

- machine and plant constructions
- automotive
- railway industry
- shipbuilding
- automation
- electrical installations
- sensor technology
- emc applications
- ex-area acc to EN 1127-1

Messingdruckring zur EMV-sicheren Montage verwenden.  
EMV-Montageanleitung beachten.

Use brass thrust collar for EMC-safe mounting.  
See of EMC assembly instructions .

## LIEFERLÄNGEN

Fixlängen sind mit Anschlussteilen EMV gerecht montiert.

## PRODUCT LENGTHS

Fixed lengths mounted with connecting elements acc to EMC specifications.

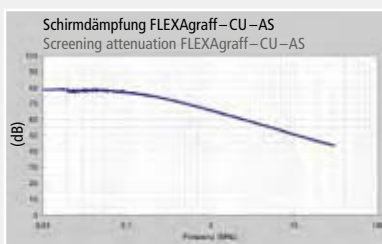

FLEXA No.

AD  
OD



ø

mm

stat

dyn

kg/m

m

1 4110 701 011	14	11,0 x 14,0	50	125	0,164	25
1 4110 701 013	17	13,0 x 17,0	60	150	0,360	25
1 4110 701 015	19	15,0 x 19,0	67	170	0,330	25
1 4110 701 017	21	17,0 x 21,0	70	175	0,350	25
1 4110 701 023	27	23,0 x 27,0	90	225	0,575	25
1 4110 701 029	36	29,0 x 36,0	130	325	0,860	10
1 4110 701 038	45	38,0 x 45,0	150	375	1,100	10
1 4110 701 049	56	49,0 x 56,0	210	525	1,420	10

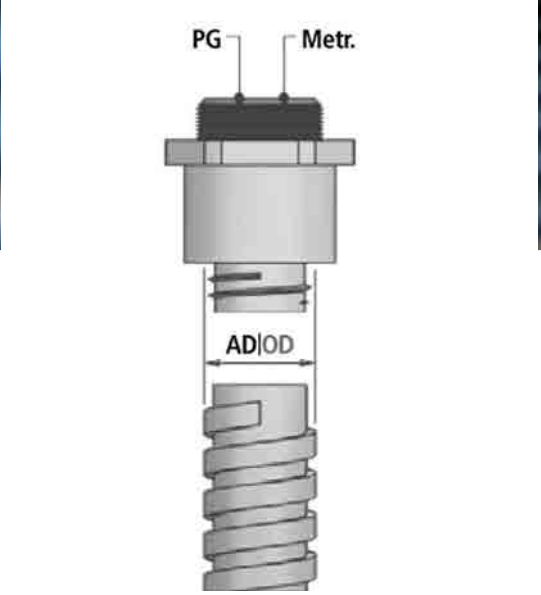
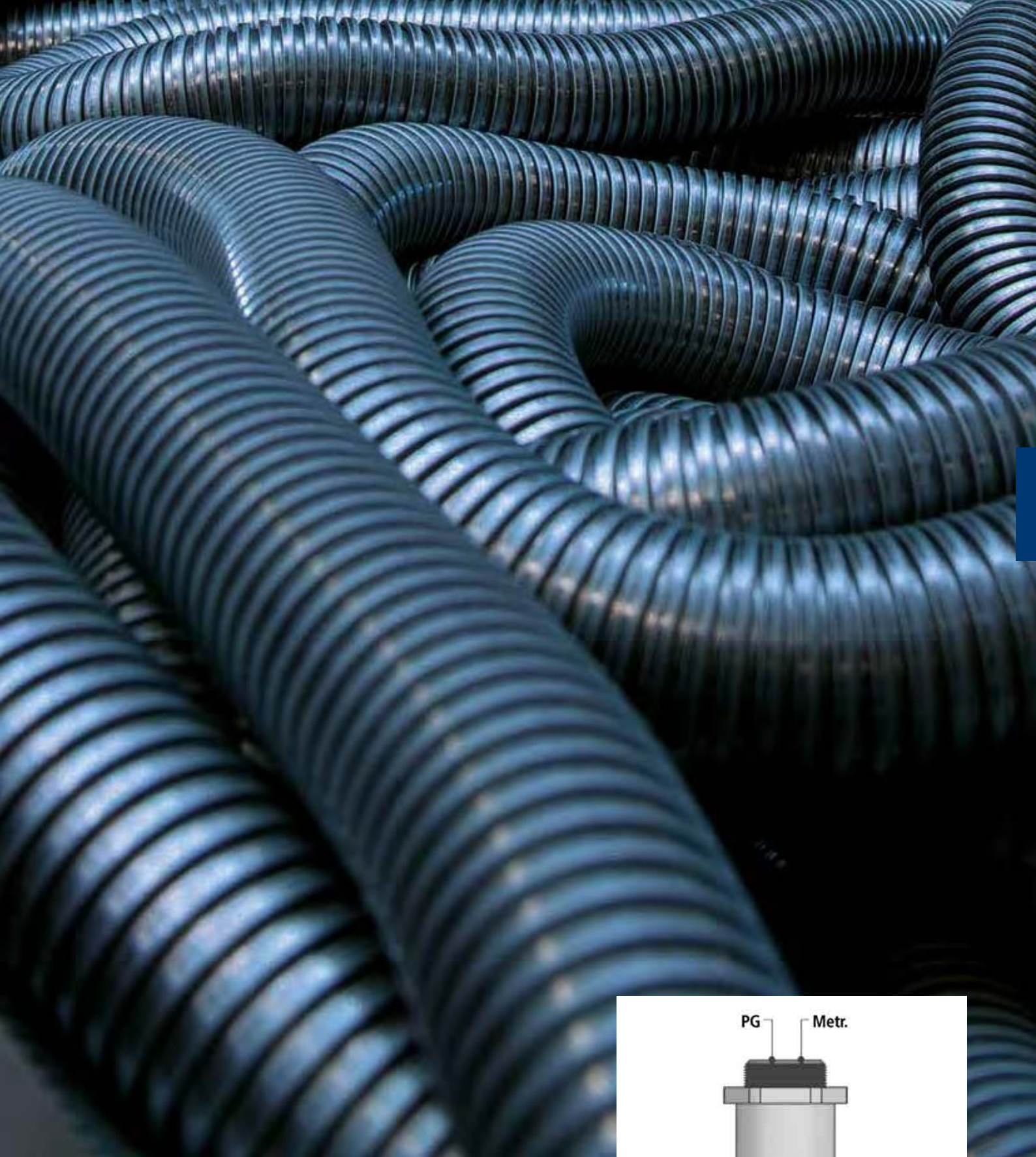

# 05

## METALLSCHUTZSCHLÄUCHE FLÜSSIGKEITSDICHT PROTECTIVE METAL CONDUITS LIQUID TIGHT



PASSENDE VERSCHRAUBUNGEN  
APPROPRIATE CONNECTORS



US-M US2-M USDR-M USZ- USB-M USW-M LI-M LIF-M USD-M US- EG-M EW45190-M  
US-P EX-M USW-P LI-P LIF-P USD-P FOOD-M EG-P EW45190-P

SPR-PVC-AS	✓	✓	✓	✓	✓	✓	✓	✓						
SPR-PA	✓	✓	✓	✓	✓	✓	✓	✓						
SPR-PU-AS	✓	✓	✓	✓	✓	✓	✓	✓						
SPR-PU-F	✓	✓	✓	✓	✓	✓	✓	✓						
SPR-PVC-EDU-AS	✓					✓								
FLEXAgraff®-PU-AS	✓	✓	✓		✓	✓								
FLEXAgraff®-PU-F	✓	✓	✓	✓	✓	✓	✓	✓						
FLEXAgraff®-SI-ASF	✓					✓								
FLEXAgraff®-CU-PU									✓					
LIQUID-TIGHT- EF												✓	✓	✓
LIQUID-TIGHT- EF-OR												✓	✓	✓
LIQUID-TIGHT- UL-CSA												✓	✓	✓
LIQUID-TIGHT-FOOD												✓		



Schienefahrzeugindustrie  
Railway Technology



EMV-Anwendungen  
EMC Applications



Sensortechnik  
Sensor Technology



Lebensmittelindustrie  
Food and beverage

**SPR – PVC – AS | SPR – PVC**

Stahl verzinkt  
 S Profil  
 PVC-Mantel  
 Galvanized steel  
 S profile  
 PVC sheathing



05.2

**SPR – PA**

Stahl verzinkt  
 S Profil  
 PA-Mantel  
 Galvanized steel  
 S profile  
 PA sheathing



05.4

**SPR – PU – AS**

Stahl verzinkt  
 S Profil  
 ölbeständiger PU-Mantel  
 Galvanized steel  
 S profile  
 oil-resistant PU sheathing

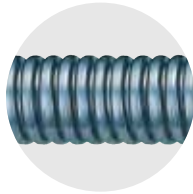

05.5

**SPR – PU – F**

Stahl verzinkt  
 S Profil  
 flammwidriger PU-Mantel  
 Galvanized steel  
 S profile  
 flame retardant PU sheathing



05.6

**SPR – PVC – EDU – AS**

Stahl verzinkt  
 S Profil  
 PVC-Mantel  
 Stahldrahtumflechtung  
 Galvanized steel  
 S profile  
 PVC sheathing  
 galvanized steel wire braiding

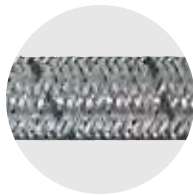

05.7

**FLEXAgraff® – PU – AS**

Stahl verzinkt  
 Agraff-Profil  
 ölbeständiger PU-Mantel  
 Galvanized steel  
 Agraff profile  
 oil-resistant PU sheathing

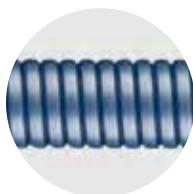

05.8

**FLEXAgraff® – PU – F**

Stahl verzinkt  
 Agraff-Profil  
 flammwidriger PU-Mantel  
 Galvanized steel  
 Agraff profile  
 flame retardant PU sheathing



05.9

**FLEXAgraff® – SI – ASF**

Stahl verzinkt  
 Agraff Profil  
 SI-Mantel  
 Galvanized steel  
 Agraff profile  
 SI sheathing

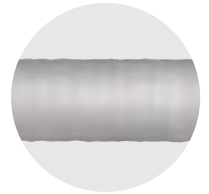

05.10

**FLEXAgraff® – CU – PU**

Stahl verzinkt  
 Agraff Profil  
 CU-Umflechtung, PU-Mantel  
 Galvanized steel  
 Agraff profile  
 CU braiding, PU sheathing

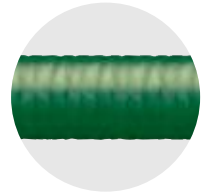

05.11

**LIQUID – TIGHT – EF**

Stahl verzinkt  
 flammwidriger, glatter PVC-Mantel  
 Galvanized steel  
 flame resistant, smooth PVC sheathing

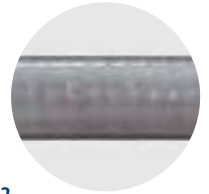

05.12

**LIQUID – TIGHT – EF – OR**

Stahl verzinkt  
 ölresistenter glatter PVC-Mantel  
 Galvanized steel  
 oil-resistant, smooth PVC sheathing



05.13

**LIQUID – TIGHT – UL – CSA**

Stahl verzinkt mit Kupfer-  
 Erdleiter, glatter PVC-Mantel  
 Galvanized steel with copper  
 ground lead and smooth PVC sheathing

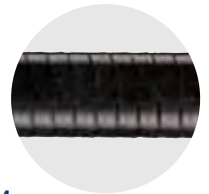

05.14

**LIQUID – TIGHT – FOOD**

Stahl verzinkt  
 lebensmittelechter PU-Mantel  
 Galvanized steel  
 food-safe PU sheathing

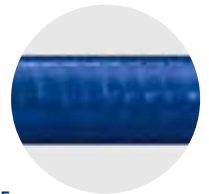

05.15

# SPR-PVC-AS

IP 68  
-25°C ... +90°C ^ +100°C

EN / IEC 61386-23



Passende Verschraubungen  
Suitable connectors

		Seite   page	
	US-M	08. 2 - 4	IP 65
	US-P	08. 5 - 7	
	US2-M	08. 8	IP 65
	USDR-M	08.10	IP 65
	USZ-M	08.12	IP 65
	LI-M P	08.18	IP 40
	LIF-M P	08.19	IP 40
	USB-M	08.20	IP 65
	USW-M	08.22-23	IP 65
	USW-P	08.24-25	

Metall-Schutzschlauch  
Stahl verzinkt  
PVC-Mantel, nicht flammverbreitend

Protective metal conduit  
galvanized steel  
PVC sheathing, non flame propagating

## KONSTRUKTION

wendelgewickelt  
S Profil  
PVC-Mantel

## STRUCTURE

strip-wound  
S profile  
PVC sheathing

## MATERIAL

**Schutzschlauch:** Kaltband DC 03/04  
nach EN 10139, verzinkt, Fe/Zn 3  
**Andere Werkstoffe:**  
Aluminium, nichtrostender Stahl,  
Messing blank oder vernickelt  
**Mantel:** PVC  
Weitere Werkstoffe auf Anfrage

## MATERIAL

**Conduit:** cold strip DC 03/04  
acc. to EN 10139, galvanized, Fe/Zn 3  
**Further materials:**  
aluminium, stainless steel,  
polished or nickel-plated brass  
**Sheathing:** PVC  
Please ask for further materials

## EIGENSCHAFTEN

- wetterfest
- wasserdicht
- weitgehend seewasser-, säure-, ölbeständig
- silikon- und cadmiumfrei
- sehr flexibel
- zugfest
- querdruckbelastbar
- DIN 49012, Bauform I geprüft  
nach DIN EN IEC 61386-23

## PROPERTIES

- weatherproof
- watertight
- widely resistant to seawater, acids, oils
- free of silicone and cadmium
- very flexible
- stretch-resistant
- compression-resistant
- DIN 49012, structural shape I, approved  
acc. to DIN EN IEC 61386-23

## ANWENDUNGSGEBIETE

- Maschinen- und Anlagenbau
- Schiffsbau
- Automation
- Elektroanlagen
- Sensortechnik

## APPLICATION

- machine and plant constructions
- shipbuilding
- automation
- electrical installations
- sensor technology



FLEXA No.	FLEXA No.	AD OD				
schwarz black	grau grey	ø	mm	stat dyn	kg m	m

1 2010 112 007	1 2010 111 007	10	7,0 x 10,0	25	65	0,079	50
1 2010 112 010	1 2010 111 010	14	10,0 x 14,0	37	95	0,130	50
1 2010 112 013	1 2010 111 013	17	13,0 x 17,0	45	115	0,170	50
1 2010 112 015	1 2010 111 015	19	15,0 x 19,0	50	120	0,190	50
1 2010 112 017	1 2010 111 017	21	17,0 x 21,0	55	140	0,240	50
1 2010 112 022	1 2010 111 022	27	22,0 x 27,0	60	150	0,360	50
1 2010 112 029	1 2010 111 029	36	29,0 x 36,0	90	225	0,600	25
1 2010 112 038	1 2010 111 038	45	38,0 x 45,0	120	300	0,740	25
1 2010 112 049	1 2010 111 049	56	49,0 x 56,0	130	325	0,900	25

Verkaufsverpackung 10 m | 10 m sales pack

1 2011 112 007	1 2011 111 007	10	7,0 x 10,0	25	65	0,079	10
1 2011 112 010	1 2011 111 010	14	10,0 x 14,0	37	95	0,130	10
1 2011 112 013	1 2011 111 013	17	13,0 x 17,0	45	115	0,170	10
1 2011 112 015	1 2011 111 015	19	15,0 x 19,0	50	120	0,190	10
1 2011 112 017	1 2011 111 017	21	17,0 x 21,0	55	140	0,240	10
1 2011 112 022	1 2011 111 022	27	22,0 x 27,0	60	150	0,360	10
1 2011 112 029	1 2011 111 029	36	29,0 x 36,0	90	225	0,600	10
1 2011 112 038	1 2011 111 038	45	38,0 x 45,0	120	300	0,740	10**
1 2011 112 049	1 2011 111 049	56	49,0 x 56,0	130	325	0,900	10**

\*\* in Ringen \*\* in rings

# SPR-PVC

Metall-Schutzschlauch  
Stahl verzinkt  
PVC-Mantel  
nicht flammverbreitend

Protective metal conduit  
galvanized steel  
PVC sheathing  
non flame propagating



IP 68  
-25°C ... +90°C ^ +100°C

## KONSTRUKTION

wendelgewickelt  
S Profil  
PVC-Mantel

## STRUCTURE

strip-wound  
S profile  
PVC sheathing



## MATERIAL

**Schutzschlauch:** Kaltband DC 03/04  
nach EN 10139, verzinkt, Fe/Zn 3  
Andere Werkstoffe:  
Aluminium, nichtrostender Stahl,  
Messing blank oder vernickelt  
**Mantel:** PVC  
Weitere Werkstoffe auf Anfrage

## MATERIAL

**Conduit:** cold strip DC 03/04  
acc. to EN 10139, galvanized, Fe/Zn 3  
Further materials:  
aluminium, stainless steel,  
polished or nickel-plated brass  
**Sheathing:** PVC  
Please ask for further materials

## EIGENSCHAFTEN

- wetterfest
- wasserdicht
- weitgehend seewasser-, säure- und ölbeständig
- silikon- und cadmiumfrei
- sehr flexibel
- zugfest
- querdruckbelastbar

## PROPERTIES

- weatherproof
- watertight
- widely resistant to seawater, acids and oils
- free of silicone and cadmium
- very flexible
- stretch-resistant
- compression-resistant

## ANWENDUNGSGEBIETE

- Maschinen- und Anlagenbau
- Schiffsbau
- Automation
- Elektroanlagen
- Sensortechnik

## APPLICATION

- machine and plant constructions
- shipbuilding
- automation
- electrical installations
- sensor technology



### FLEXA No.

schwarz black



mm



stat dyn



m



kg/m



m



FLEXA No.	mm	stat	dyn	m	kg/m	m
1 2010 102 004	4,0 x 7,0	17	45	500	0,060	50
1 2010 102 005	5,0 x 8,0	20	50	500	0,062	50
1 2010 102 006	6,0 x 9,0	24	60	500	0,070	50
1 2010 102 008	7,5 x 11,0	35	90	500	0,085	50
1 2010 102 009	9,0 x 12,0	40	100	500	0,105	50

Weitere Farben auf Anfrage Further colours on request



IP 68  
-50°C ... +120°C ^ +150°C

EN / IEC 61386-23



Passende Verschraubungen  
Suitable connectors

Seite | page

	US-M	08. 2- 4	IP 65
	US-P	08. 5- 7	
	US2-M	08. 8	IP 65
	USDR-M	08.10	IP 65
	USZ-M	08.12	IP 65
	LI-M P	08.18	IP 40
	LIF-M P	08.19	IP 40
	USB-M	08.20	IP 65
	USW-M	08.22- 23	IP 65
	USW-P	08.24- 25	



## SPR-PA

Metall-Schutzschlauch  
Stahl verzinkt  
PA-Mantel

Protective metal conduit  
galvanized steel  
PA sheathing

### KONSTRUKTION

wendelgewickelt  
S Profil  
PA-Mantel

### STRUCTURE

strip-wound  
S profile  
PA sheathing

### MATERIAL

**Schutzschlauch:** Kaltband DC 03/04  
nach EN 10139, verzinkt, Fe/Zn 3  
**Mantel:** Polyamid [PA]

### MATERIAL

**Conduit:** cold strip DC 03/04  
acc. to EN 10139, galvanized, Fe/Zn 3  
**Sheathing:** polyamide [PA]

### EIGENSCHAFTEN

- flüssigkeitsdicht
- zugfest
- querdruckbelastbar
- öl- und benzinbeständig
- weitgehend säure- und lösungsmittelbeständig
- UV-beständig
- halogen-, silikon-, cadmiumfrei
- DIN 49012, Bauform I, geprüft nach DIN EN IEC 61386-23

### PROPERTIES

- liquid tight
- stretch resistant
- compression resistant
- resistant to oil and benzine
- widely resistant to acids and solvents
- UV resistant
- free of halogen, silicone, cadmium
- DIN 49012, structural shape I, approved acc. to DIN EN IEC 61386-23

### ANWENDUNGSGEBIETE

- Maschinen- und Anlagenbau
- Fahrzeugbau
- Schienenfahrzeuge
- Schiffsbau
- Automation
- Elektroanlagen

### APPLICATION

- machine and plant constructions
- automotive
- railway industry
- shipbuilding
- automation
- electrical installations

FLEXA No.

AD  
OD



schwarz black

ø

mm

stat dyn

kg/m

m



1 2013 202 007	10	7,0 x 10,0	25	65	0,085	50
1 2013 202 010	14	10,0 x 14,0	37	95	0,110	50
1 2013 202 013	17	13,0 x 17,0	45	115	0,148	50
1 2013 202 015	19	15,0 x 19,0	50	120	0,150	50
1 2013 202 017	21	17,0 x 21,0	55	140	0,220	50
1 2013 202 022	27	22,0 x 27,0	60	150	0,320	50
1 2013 202 029	36	29,0 x 36,0	90	225	0,520	25
1 2013 202 038	45	38,0 x 45,0	120	300	0,600	25
1 2013 202 049	56	49,0 x 56,0	130	325	0,800	25



# SPR-PU-AS

Metall-Schutzschlauch  
Stahl verzinkt  
ölbeständiger PU-Mantel

Protective metal conduit  
galvanized steel  
oil resistant PU sheathing

IP 68  
-50°C ... +100°C ^ +130°C

## KONSTRUKTION

wendelgewickelt  
S Profil  
PU-Mantel

## STRUCTURE

strip-wound  
S profile  
PU sheathing

## MATERIAL

**Schutzschlauch:** Kaltband DC 03/04  
nach EN 10139, verzinkt, Fe/Zn 3  
**Mantel:** Polyurethan [PU]

## MATERIAL

**Conduit:** cold strip DC 03/04  
acc. to EN 10139, galvanized, Fe/Zn 3  
**Sheathing:** polyurethane [PU]

## EIGENSCHAFTEN

- V2 nach UL 94
- öl-, benzin-, fettbeständig
- weitgehend lösungsmittel- und säurebeständig
- halogen-, silikon-, cadmiumfrei
- hohe Zähigkeit und Abriebbeständigkeit
- hervorragendes Verhalten bei tiefen Temperaturen
- sehr flexibel
- mikrobebeständig
- DIN 49012, Bauform I, geprüft nach DIN EN IEC 61386-23

## PROPERTIES

- V2 according to UL 94
- oil, benzene, and grease resistant
- widely resistant to solvents and acids
- free of halogen, silicone, cadmium
- high tenacity and abrasion resistance
- outstanding performance at low temperatures
- very flexible
- microbe resistant
- DIN 49012, structural shape I, approved acc. to DIN EN IEC 61386-23

## ANWENDUNGSGEBIETE

- Maschinen- und Anlagenbau
- Fahrzeugbau
- Schiffsbau
- Automation
- Elektroanlagen

## APPLICATION

- machine and plant constructions
- automotive
- shipbuilding
- automation
- electrical installations

EN / IEC 61386-23



Passende Verschraubungen  
Suitable connectors

Seite | page

		Seite   page	
	US-M	08. 2 - 4	IP 65
	US-P	08. 5 - 7	
	US2-M	08. 8	IP 65
	USDR-M	08.10	IP 65
	USZ-M	08.12	IP 65
	LI-M P	08.18	IP 40
	LIF-M P	08.19	IP 40
	USB-M	08.20	IP 65
	USW-M	08.22-23	IP 65
	USW-P	08.24-25	



FLEXA No.

AD  
OD



metallic blau metallic blue

ø

mm

stat dyn

kg/m

m



1 2210 711 007	10	7,0 x 10,0	25	65	0,077	50
1 2210 711 010	14	10,0 x 14,0	37	95	0,120	50
1 2210 711 013	17	13,0 x 17,0	45	115	0,150	50
1 2210 711 017	21	17,0 x 21,0	55	140	0,230	50
1 2210 711 022	27	22,0 x 27,0	60	150	0,320	50
1 2210 711 029	36	29,0 x 36,0	90	225	0,560	25
1 2210 711 038	45	38,0 x 45,0	120	300	0,720	25
1 2210 711 049	56	49,0 x 56,0	130	325	0,900	25





IP 68  
-50°C ... +100°C ^ +130°C

EN / IEC 61386-23



EN 45545-2 [HL 3]



Passende Verschraubungen  
Suitable connectors

		Seite   page	
	US-M US-P	08. 2- 4 08. 5- 7	IP 65
	US2-M	08. 8	IP 65
	USDR-M	08.10	IP 65
	USZ-M	08.12	IP 65
	LI-M -P	08.18	IP 40
	LIF-M -P	08.19	IP 40
	USB-M	08.20	IP 65
	USW-M USW-P	08.22-23 08.24-25	IP 65



## SPR-PU-F

Metall-Schutzschlauch  
Stahl verzinkt  
flammwidriger PU-Mantel

Protective metal conduit  
galvanized steel  
flame retardant PU sheathing

### KONSTRUKTION

wendelgewickelt  
S Profil  
PU-Mantel

### STRUCTURE

strip-wound  
S profile  
PU sheathing

### MATERIAL

**Schutzschlauch:** Kaltband DC 03/04  
nach EN 10139, verzinkt, Fe/Zn 3  
**Mantel:** Polyurethan [PU]

### MATERIAL

**Conduit:** cold strip DC 03/04  
acc. to EN 10139, galvanized, Fe/Zn 3  
**Sheathing:** polyurethane [PU]

### EIGENSCHAFTEN

- V0 nach UL 94
- flammwidrig
- selbstverlöschend
- wetterfest
- weitgehend seewasser-, säure- und ölbeständig
- halogen-, silikon-, cadmiumfrei
- querdruckbelastbar
- mikrobebeständig
- geprüft nach DIN 5510, Teil 2  
EN 45545-HL3  
NFF 16-101 /102  
DIN EN IEC 61386-23

### PROPERTIES

- V0 according to UL 94
- flame-retardant
- self-extinguishing
- weatherproof
- widely resistant to seawater, acids and oils
- free of halogen, silicone, cadmium
- compression-resistant
- microbe resistant
- approved acc. to DIN 5510, part 2  
EN45545-HL3  
NFF 16-101 /102  
DIN EN IEC 61386-23

### ANWENDUNGSGEBIETE

- Maschinen- und Anlagenbau
- Fahrzeugbau
- Schienenfahrzeuge
- Schiffsbau
- Automation
- Elektroanlagen

### APPLICATION

- machine and plant constructions
- automotive
- railway industry
- shipbuilding
- automation
- electrical installations



FLEXA No.

AD  
OD



schwarz black

ø

mm

stat dyn

kg/m

m



1 2213 702 007	10	7,0 x 10,0	25	65	0,090	50
1 2213 702 010	14	10,0 x 14,0	37	95	0,120	50
1 2213 702 013	17	13,0 x 17,0	45	115	0,150	50
1 2213 702 017	21	17,0 x 21,0	55	140	0,230	50
1 2213 702 022	27	22,0 x 27,0	60	150	0,320	50
1 2213 702 029	36	29,0 x 36,0	90	225	0,620	25
1 2213 702 038	45	38,0 x 45,0	120	300	0,700	25
1 2213 702 049	56	49,0 x 56,0	130	325	1,080	25

# SPR–PVC–EDU–AS

Metall-Schutzschlauch  
Stahl verzinkt  
PVC-Mantel  
verzinkte Stahldrahtumflechtung

Protective metal conduit  
galvanized steel  
PVC sheathing  
galvanized steel wire braiding

IP 68  
-25°C ... +90°C ^ +100°C

## KONSTRUKTION

wendelgewickelt  
S Profil  
PVC-Mantel  
verzinkte Stahldrahtumflechtung

## STRUCTURE

strip-wound  
S profile  
PVC sheathing  
galvanized steel wire braiding

EN / IEC 61386-23



## MATERIAL

**Schutzschlauch:** Kaltband DC 03/04  
nach EN 10139, verzinkt, Fe/Zn 3  
**Mantel:** PVC  
**Umflechtung:** verzinkter Stahldraht

## MATERIAL

**Conduit:** cold strip DC 03/04  
acc to EN 10139, galvanized, Fe/Zn 3  
**Sheathing:** PVC  
**Braiding:** galvanized steel wire

Passende Verschraubungen  
Suitable connectors

Seite | page

	US–M	08. 2- 4	IP 54
	US–P	08. 5- 7	
	USW–M	08.22- 23	IP 54
	USW–P	08.24- 25	

## EIGENSCHAFTEN

- Schutz vor heißen Spänen
- weitgehend ölbeständig
- silikon- und cadmiumfrei
- sehr flexibel
- DIN 49012, Bauform M  
geprüft nach DIN EN IEC 61386-23

## PROPERTIES

- protection from hot swarfs
- widely resistant against oils
- free of silicone and cadmium
- very flexible
- DIN 49012, structural shape M  
approved acc. to DIN EN IEC 61386-23

## ANWENDUNGSGEBIETE

- Maschinen- und Anlagenbau  
Spritzgussmaschinen  
Zerspanungsmaschinen
- Fahrzeugbau
- Schiffsbau
- Automation
- Elektroanlagen

## APPLICATION

- machine and plant constructions  
injection moulding machines  
metal cutting machines
- automotive
- shipbuilding
- automation
- electrical installations



FLEXA No.

AD  
OD



ø



mm stat dyn



kg/m



m

FLEXA No.	AD OD	ø	mm	stat	dyn	kg/m	m
1 4210 101 009	14		10,0 x 14,0	37	95	0,180	50
1 4210 101 012	17		12,0 x 17,0	45	115	0,280	50
1 4210 101 016	21		16,0 x 21,0	55	140	0,330	50
1 4210 101 021	27		21,0 x 27,0	60	150	0,510	50
1 4210 101 028	36		28,0 x 36,0	90	225	0,800	25
1 4210 101 037	45		37,0 x 45,0	120	300	1,060	25
1 4210 101 047	56		48,0 x 56,0	130	325	1,320	25

# FLEXAgraff® – PU – AS

IP 68  
-50°C ... +100°C ^ +130°C

EN / IEC 61386-23



Passende Verschraubungen  
Suitable connectors

		Seite   page	
	US-M	08. 2- 4	IP 65
	US-P	08. 5- 7	
	US2-M	08. 8	IP 65
	USDR-M	08.10	IP 65
	USZ-M	08.12	IP 65
	USB-M	08.20	IP 65
	USW-M	08.22- 23	IP 65
	USW-P	08.24- 25	

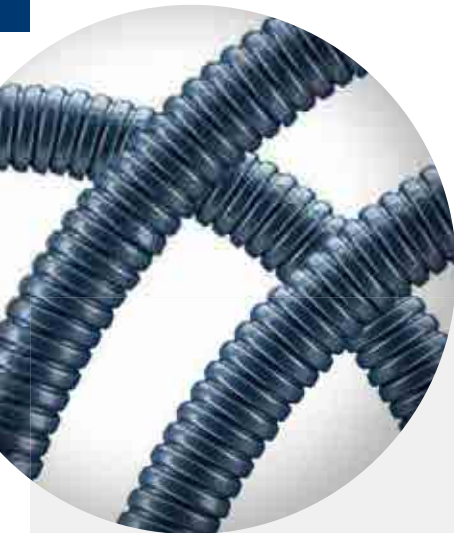

Metall-Schutzschlauch  
Stahl verzinkt  
ölbeständiger PU-Mantel

Protective metal conduit  
galvanized steel  
oil resistant PU sheathing

## KONSTRUKTION

wendelgewickelt  
Agraff Profil [doppelt gefalzt]  
PU-Mantel

## STRUCTURE

strip-wound  
Agraff profile [double overlapped]  
PU sheathing

## MATERIAL

**Schutzschlauch:** Kaltband DC 03/04  
nach EN 10139, verzinkt, Fe/Zn 3  
**Mantel:** Polyurethan [PU]

## MATERIAL

**Conduit:** cold strip DC 03/04  
acc. to EN 10139, galvanized, Fe/Zn3  
**Sheathing:** polyurethane [PU]

## EIGENSCHAFTEN

- V2 nach UL 94
- hohe Zug- und Verdrehfestigkeit
- öl-, benzin-, fettbeständig
- weitgehend lösungsmittel-|säurebeständig
- halogen-, silikon-, cadmiumfrei
- gutes Verhalten bei tiefen Temperaturen
- kein Aufdrehen des Schlauches
- sehr flexibel
- hohe Abschirmung
- mikrobenbeständig
- flammgeschützt
- geprüft nach DIN EN IEC 61386-23

## PROPERTIES

- V2 according to UL 94
- high tensile and twisting strength
- resistant to oil, benzine and grease
- widely resistant to solvents and acids
- free of halogen, silicone, cadmium
- good performance at low temperatures
- no untwisting of the conduit
- very flexible
- high shielding factor
- microbe resistant
- flame-resistant
- approved acc. to DIN EN IEC 61386-23

## ANWENDUNGSGEBIETE

- Maschinen- und Anlagenbau
- Fahrzeugbau
- Schiffsbau
- Automation
- Elektroanlagen

## APPLICATION

- machine and plant constructions
- automotive
- shipbuilding
- automation
- electrical installations

FLEXA No.

AD  
OD



metallisch blau metallic blue

ø

mm

stat

dyn

kg/m

m



1 2130 101 007	10	7,0 x 10,0	35	90	0,110	50
1 2130 101 011	14	11,0 x 14,0	45	115	0,150	50
1 2130 101 013	17	13,0 x 17,0	50	125	0,260	50
1 2130 101 017	21	17,0 x 21,0	75	190	0,300	50
1 2130 101 023	27	23,0 x 27,0	115	290	0,440	50
1 2130 101 029	36	29,0 x 36,0	125	315	0,685	25
1 2130 101 038	45	38,0 x 45,0	175	440	0,960	25
1 2130 101 049	56	49,0 x 56,0	240	600	1,200	25
Verkaufsverpackung 10 m   10 m sales pack						
1 2131 101 007	10	7,0 x 10,0	35	90	0,110	10
1 2131 101 011	14	11,0 x 14,0	45	115	0,150	10
1 2131 101 013	17	13,0 x 17,0	50	125	0,260	10
1 2131 101 017	21	17,0 x 21,0	75	190	0,300	10
1 2131 101 023	27	23,0 x 27,0	115	290	0,440	10
1 2131 101 029	36	29,0 x 36,0	125	315	0,685	10
1 2131 101 038	45	38,0 x 45,0	175	440	0,960	10**
1 2131 101 049	56	49,0 x 56,0	240	600	1,200	10**

\*\* in Ringen in rings

# FLEXAgraff® – PU – F

Metall-Schutzschlauch  
Stahl verzinkt  
flammwidriger PU-Mantel

Protective metal conduit  
galvanized steel  
flame retardant PU sheathing

## KONSTRUKTION

wendelgewickelt  
Agraff Profil [doppelt gefalzt]  
PU-Mantel

## STRUCTURE

strip-wound  
Agraff profile [double overlapped]  
PU sheathing

## MATERIAL

**Schutzschlauch:** Kaltband DC 03/04  
nach EN 10139, verzinkt, Fe/Zn 3  
**Mantel:** Polyurethan [PU]

## MATERIAL

**Conduit:** cold strip DC 03/04  
acc to EN 10139, galvanized, Fe/Zn 3  
**Sheathing:** polyurethane [PU]

## EIGENSCHAFTEN

- V0 nach UL 94
- flammwidrig
- selbstverlöschend
- wetterfest
- weitgehend seewasser-, säure- und ölbeständig
- halogen-, silikon-, cadmiumfrei
- querdruckbelastbar
- geprüft nach  
DIN EN IEC 61386-23  
DIN 5510, Teil 2  
EN 45545-HL3  
NFF 16-101/102

## PROPERTIES

- V0 according to UL 94
- flame retardant
- self-extinguishing
- weatherproof
- widely resistant to seawater, acids and oils
- free of halogen, silicone, cadmium
- resistant to compression
- approved acc. to  
DIN EN IEC 61386-23  
DIN 5510, part 2  
EN 45545-HL3  
NFF 16-101/102

## ANWENDUNGSGEBIETE

- Maschinen- und Anlagenbau
- Fahrzeugbau
- Schienenfahrzeuge  
schwere mechanische Beanspruchung
- Schiffsbau
- Automation
- Elektroanlagen

## APPLICATION

- machine and plant constructions
- automotive
- railway industry  
heavy mechanical load
- shipbuilding
- automation
- electrical installations



IP 68  
-50°C ... +100°C ^ +130°C

EN / IEC 61386-23



EN 45545-2 [HL 3]



Passende Verschraubungen  
Suitable connectors

		Seite   page	
	US-M	08. 2 - 4	IP 65
	US-P	08. 5 - 7	
	US2-M	08. 8	IP 65
	USDR-M	08.10	IP 65
	USZ-M	08.12	IP 65
	LI-M P	08.18	IP 40
	LIF-M P	08.19	IP 40
	USB-M	08.20	IP 65
	USW-M	08.22-23	IP 65
	USW-P	08.24-25	

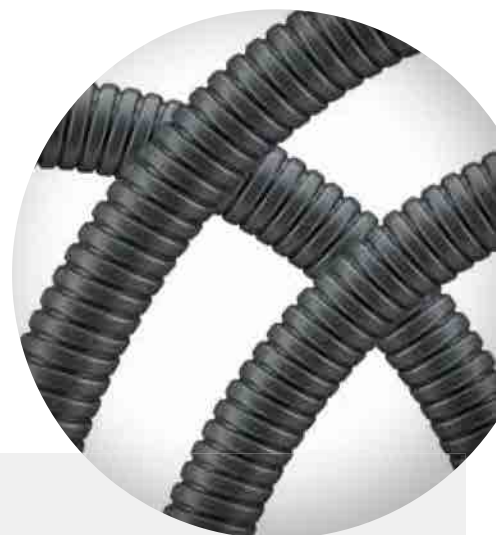

FLEXA No.

AD  
OD



schwarz black

ø

mm

stat

dyn

kg|m

m



1 2133 702 007	10	7,0 x 10,0	35	90	0,110	50
1 2133 702 011	14	11,0 x 14,0	45	115	0,150	50
1 2133 702 013	17	13,0 x 17,0	50	125	0,260	50
1 2133 702 017	21	17,0 x 21,0	75	190	0,300	50
1 2133 702 023	27	23,0 x 27,0	115	290	0,440	50
1 2133 702 029	36	29,0 x 36,0	125	315	0,725	25
1 2133 702 038	45	38,0 x 45,0	175	440	0,960	25
1 2133 702 049	56	49,0 x 56,0	240	600	1,200	25

# FLEXAgraff® –SI–ASF

🔴 IP 68  
 🌡️ -50°C ... +180°C

EN / IEC 61386-23



Passende Verschraubungen  
 Suitable connectors

Seite | page

	US-M	08. 2- 4	IP 66
	US-P	08. 5- 7	
	USW-M	08.22-23	IP 66
	USW-P	08.24-25	



Metall-Schutzschlauch  
 Stahl verzinkt  
 SI-Mantel  
 nicht flammverbreitend

Protective metal conduit  
 galvanized steel  
 SI sheathing  
 non flame propagating

## KONSTRUKTION

wendelgewickelt  
 Agraff Profil [doppelt gefalzt]  
 SI-Mantel

## STRUCTURE

strip-wound  
 Agraff profile [double overlapped]  
 SI sheathing

## MATERIAL

**Schutzschlauch:** Kaltband DC 03/04  
 nach EN 10139, verzinkt, Fe/Zn3  
**Mantel:** Silikon [SI]

## MATERIAL

**Conduit:** cold strip, DC 03/04  
 acc. to EN 10139, galvanized, Fe/Zn3  
**Sheathing:** silicone [SI]

## EIGENSCHAFTEN

- hohe Zug- und Verdrehfestigkeit
- gute elektrische Isolation
- sehr gute Beständigkeit gegen Ozon, UV-Strahlen und Witterungseinflüsse
- kein Aufdrehen des Schlauches
- sehr flexibel
- hoher Abschirmfaktor
- schwer entflammbar
- halogenfrei
- keine Bildung von toxischen und korrosiven Brandgasen
- hochtemperaturbeständig
- geprüft nach DIN EN IEC 61386-23

## PROPERTIES

- high tensile and torsional strenght
- good electrical insulation
- very good resistance against ozone, ultra-violet radiation and atmospheric influences
- no untwisting of the conduit
- very flexible
- high shielding factor
- low flammability
- free of halogen
- no appearance of toxic and corrosive fire gases
- high temperature resistant
- approved acc. to DIN EN IEC 61386-23

## ANWENDUNGSGEBIETE

- Maschinen- und Anlagenbau
- Fahrzeugbau
- Schiffsbau
- Automation
- Elektroanlagen
- Kraftwerke

## APPLICATION

- machine and plant constructions
- automotive
- shipbuilding
- automation
- electrical installations
- power plants

## HINWEIS

Für den Einsatz über +80°C sind PTFE-Dichtringe, Typ TED für die Verschraubungen erforderlich.

## NOTE

For applications exceeding +80°C, PTFE-sealings, type TED, are required for the connectors.



FLEXA No.

AD  
OD



grau grey

ø

mm

stat

dyn

kg|m

m



1 2140 801 010	14	10,0 x 14,0	50	125	0,180	50
1 2140 801 012	17	12,0 x 17,0	60	150	0,230	50
1 2140 801 016	21	16,0 x 21,0	70	175	0,370	50
1 2140 801 022	27	21,0 x 27,0	90	225	0,050	50
1 2140 801 028	36	27,0 x 36,0	130	325	0,860	25
1 2140 801 037	45	37,0 x 45,0	150	375	1,000	25
1 2140 801 048	56	47,0 x 56,0	210	525	1,480	25

# FLEXAgraff® – CU – PU

Metall-Schutzschlauch  
Stahl verzinkt  
CU-Umflechtung, PU-Mantel

Protective metal conduit  
galvanized steel  
CU braiding, PU sheathing



IP 68  
-50°C ... +100°C ^ +130°C

## KONSTRUKTION

wendelgewickelt  
Agraff Profil [doppelt gefalzt]  
CU-Umflechtung  
PU-Mantel

## STRUCTURE

strip-wound  
Agraff profile [double overlapped]  
CU braiding  
PU sheathing

## MATERIAL

**Schutzschlauch:** Kaltband DC 03/04  
nach EN 10139, verzinkt, Fe/Zn 3  
**Umflechtung:** Kupferdraht verzinkt [CU]  
**Mantel:** Polyurethan [PU]

## MATERIAL

**Conduit:** cold strip DC 03/04  
acc to EN 10139, galvanized, Fe/Zn 3  
**Braiding:** tinned copper wire [CU]  
**Sheathing:** polyurethane [PU]

EN / IEC 61386-23

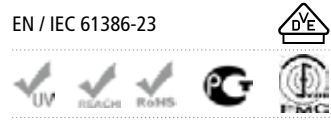

Passende Verschraubung  
Suitable connector

Seite | page



USD – M | – P 08.16

IP 67

## EIGENSCHAFTEN

- V2 nach UL 94
- erhöhte Zug- und Verdrehfestigkeit
- flüssigkeitsdicht
- weitgehend säure- und lösungsmittelbeständig
- öl-, benzin-, fettbeständig
- halogen-, silikon-, cadmiumfrei
- mikrobebeständig
- flammgeschützt
- gute EMV-Abschirmeigenschaften
- geprüft nach DIN EN IEC 61386-23
- Abschirmfaktor bis 30 MHz nach EN 50289-1-6 bis zu 80 dB

## PROPERTIES

- V2 according to UL 94
- high stretching and twisting strain
- liquid tight
- widely resistant to acids and solvents
- resistant to oil, benzine, grease
- free of halogen, silicone, cadmium
- microbe resistant
- flame-resistant
- high shielding factor [EMC]
- approved acc. to DIN EN IEC 61386-23
- screening factor up to 30 MHz acc. to EN 50289-1-6 up to 80 dB



## ANWENDUNGSGEBIETE

- Maschinen- und Anlagenbau
- Fahrzeugbau
- Schienenfahrzeuge
- Schiffsbau
- Elektroanlagen
- EMV-Anwendungen

## APPLICATION

- machine and plant constructions
- automotive
- railway industry
- shipbuilding
- electrical installations
- emc applications

## LIEFERLÄNGEN

Ab 1 m volle Meterstücke als Schlauchlänge, gestreckt gemessen  
Fixlängen werden mit Anschlusssteilen EMV gerecht montiert.

## PRODUCT LENGTHS

Full-metre lengths beginning with 1 metre precisely measured.  
Fixed lengths are mounted with connecting elements acc to emc specifications.



FLEXA No.

AD  
OD



mm



stat dyn



kg|m



m

grün green

ø



FLEXA No.	ø	mm	stat	dyn	kg m	m
1 2540 707 011	14	11,0 x 15,0	50	125	0,280	25
1 2540 707 013	17	13,0 x 18,0	60	150	0,260	25
1 2540 707 017	21	17,0 x 22,0	70	175	0,480	25
1 2540 707 023	27	23,0 x 28,0	90	225	0,530	25
1 2540 707 029	36	29,0 x 37,0	130	325	1,000	10
1 2540 707 038	45	38,0 x 46,0	150	375	1,250	10
1 2540 707 049	56	49,0 x 57,0	210	525	1,690	10

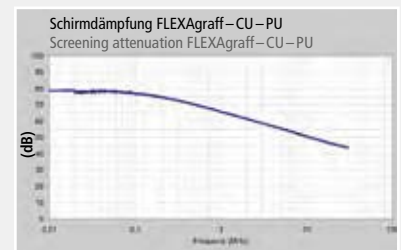

# LIQUID-TIGHT-EF

IP 68  
 -25°C ... +90°C ^ +100°C



Passende Verschraubungen  
 Suitable connectors

Seite | page

	EG-M P	08.29	IP 67
	EW 45-M P	08.30	IP 67
	EW 90-M P	08.31	IP 67

Metall-Schutzschlauch  
 Stahl verzinkt  
 PVC-Mantel  
 extra flüssigkeitsdicht

Protective metal conduit  
 galvanized steel  
 PVC sheathing  
 extra liquid tight

## KONSTRUKTION

wendelgewickelt, eingehaktes Profil  
 Spezialfaden-Dichtung  
 glatter, verstärkter, flammwidriger  
 PVC-Mantel

## STRUCTURE

strip-wound, hooked profile  
 special fibre sealing  
 smooth, reinforced, flame-resistant  
 PVC sheathing

## MATERIAL

**Schutzschlauch:** Kaltband DC 03/04  
 nach EN 10139, verzinkt, Fe/Zn 3  
 mit Spezialfaden-Dichtung  
**Mantel:** flammwidriger PVC

## MATERIAL

**Conduit:** cold strip DC 03/04  
 acc. to EN 10139, galvanized, Fe/Zn 3  
 with special fibre sealing  
**Sheathing:** flame-resistant PVC

## EIGENSCHAFTEN

- besonders flüssigkeitsdicht
- weitgehend säure- und ölbeständig
- silikon- und cadmiumfrei
- flexibel
- entspricht den amerikanischen Installationsvorschriften
- geprüft nach DIN EN IEC 61386-23

## PROPERTIES

- extremely liquid-tight
- widely resistant to oils and acids
- free of silicone and cadmium
- flexible
- complies with American installation specifications
- approved acc. to DIN EN IEC 61386-23

## ANWENDUNGSGEBIETE

- Maschinen- und Anlagenbau
- Fahrzeugbau
- Schiffsbau
- Automation
- Elektroanlagen
- für internationale Anforderungen

## APPLICATION

- machine and plant constructions
- automotive
- shipbuilding
- automation
- electrical installations
- for international applications



FLEXA No.

AD  
 OD



grau grey

ø

mm

stat

dyn

kg|m

m



1 2080 111 010	5/16"	10,0 x 14,5	105	265	0,140	50
1 2080 111 012	3/8"	12,5 x 18,0	145	360	0,260	50
1 2080 111 016	1/2"	16,0 x 21,0	170	425	0,320	50
1 2080 111 021	3/4"	21,0 x 26,5	190	475	0,440	50
1 2080 111 026	1"	26,5 x 33,0	195	490	0,700	25
1 2080 111 035	1 1/4"	35,5 x 42,0	250	625	1,000	25
1 2080 111 050	2"	51,5 x 60,0	320	780	1,200	25



# LIQUID-TIGHT-EF-OR

Metall-Schutzschlauch  
Stahl verzinkt  
PVC-Mantel  
flüssigkeitsdicht und ölresistent

Protective metal conduit  
galvanized steel  
PVC sheathing  
liquid tight and oil-resistant

IP 68  
-25°C ... +90°C ^ +100°C

## KONSTRUKTION

wendelgewickelt  
eingehaktes Profil  
Spezialfaden-Dichtung  
glatter, ölresistenter PVC-Mantel

## STRUCTURE

strip-wound  
hooked profile  
special fibre sealing  
smooth, oil-resistant PVC sheathing



## MATERIAL

**Schutzschlauch:** Kaltband DC 03/04  
nach EN 10139, verzinkt, Fe/Zn 3  
mit Spezialfaden-Dichtung  
**Mantel:** ölresistentes PVC  
ölbeständig nach EN 60811-2-1

## MATERIAL

**Conduit:** cold strip, DC 03/04  
acc to EN 10139, galvanized, Fe/Zn 3  
with special fibre sealing  
**Sheathing:** oil-resistant PVC  
oil-resistant acc. to EN 60811-2-1

Passende Verschraubungen  
Suitable connectors

Seite | page

	Seite   page	IP
EG-M P	08.29	IP 67
EW 45-M P	08.30	IP 67
EW 90-M P	08.31	IP 67

## EIGENSCHAFTEN

- besonders flüssigkeitsdicht
- weitgehend säure- und benzinbeständig
- erhöht ölbeständig
- silikolfrei- und cadmiumfrei
- flexibel
- selbstverlöschend

## PROPERTIES

- extremely liquid-tight
- widely resistant to acid and petrol
- highly oil-resistant
- free of silicone and cadmium
- flexible
- self-extinguishing

## ANWENDUNGSGEBIETE

- Maschinen- und Anlagenbau
- Fahrzeugbau
- Schiffsbau
- Automation
- Elektroanlagen
- für internationale Anforderungen

## APPLICATION

- machine and plant constructions
- automotive
- shipbuilding
- automation
- electrical installations
- for international applications



FLEXA No.

AD  
OD



schwarz black

ø

mm

stat

dyn

kg/m

m

FLEXA No.	AD OD	mm	stat	dyn	kg/m	m
1 2082 102 010	5/16"	10,0 x 14,5	50	125	0,140	50
1 2082 102 012	3/8"	12,5 x 18,0	60	150	0,250	50
1 2082 102 016	1/2"	16,0 x 21,0	70	175	0,310	50
1 2082 102 021	3/4"	21,0 x 26,5	85	210	0,400	50
1 2082 102 026	1"	26,5 x 33,0	110	275	0,680	25
1 2082 102 035	1 1/4"	35,5 x 42,0	110	275	0,880	25
1 2082 102 050	2"	51,5 x 60,0	210	525	1,480	25



# LIQUID-TIGHT-UL-CSA

 IP 68  
 -25°C ... +70°C ^ +100°C



Passende Verschraubungen  
Suitable connectors

Seite | page 

	EG-M P	08.29	IP 67
	EW 45-M P	08.30	IP 67
	EW 90-M P	08.31	IP 67



Metall-Schutzschlauch  
 Stahl verzinkt, PVC-Mantel  
 UL-Approval by Underwriters'  
 Laboratories Inc. nach UL 360

Protective metal conduit  
 galvanized steel, PVC sheathing  
 UL-approval by Underwriters' Laboratories  
 Inc. acc. to UL 360

## KONSTRUKTION

wendelgewickelt, eingehaktes Profil  
eingearbeiteter Kupfer-Erdleiter  
glatter, verstärkter PVC-Mantel

## STRUCTURE

strip-wound, hooked profile  
incorporated copper ground lead  
smooth, rein-forced PVC sheathing

Nach den amerikanischen Handelsgrößen:  
von 3/8" bis 1 1/4" mit durchgehendem  
Kupfer-Erdleiter, ab 1 1/2" in Agraff-Profil  
ohne Erdleiter.

Acc. to American trade sizes: from 3/8"  
up to 1 1/4" with extended copper ground  
lead, from 1 1/2" upwards with double-  
overlapped profile without ground lead.  
Acc. to American NEC specifications from  
1 1/2" on a separate ground lead has to be  
provided.

Nach amerikanischen NEC-Vorschriften  
muss ab 1 1/2" ein separater Erdleiter  
eingezogen werden.

## MATERIAL

**Schutzschlauch:** Metallschlauch,  
 Stahl verzinkt, erhöhte Zinkauflage  
**Mantel:** flammwidriges PVC

## MATERIAL

**Conduit:** metal conduit, galvanized steel,  
 with thick zinc layer  
**Sheathing:** flame-resistant PVC

## EIGENSCHAFTEN

- besonders stabiler biegsamer Metallschlauchkern
- flüssigkeitsdicht
- weitgehend säure- und ölbeständig
- silikon- und cadmiumfrei
- flexibel

## PROPERTIES

- exceptionally solid flexible metal conduit core
- liquid tight
- widely resistant to oils and acids
- free of silicone and cadmium
- flexible

## ANWENDUNGSGEBIETE

- Maschinen- und Anlagenbau
- Fahrzeugbau
- Schiffsbau
- Automation
- Elektroanlagen
- für internationale Anforderungen

## APPLICATION

- machine and plant constructions
- automotive
- shipbuilding
- automation
- electrical installations
- for international applications



FLEXA No.

AD  
OD



schwarz black

ø

mm

stat

dyn

kg|m

m



FLEXA No.	AD OD	mm	stat	dyn	kg m	m
1 2060 112 012	3/8"	12,5 x 18,0	140	350	0,500	50
1 2060 112 016	1/2"	16,0 x 21,0	175	430	0,570	50
1 2060 112 021	3/4"	21,0 x 26,5	180	450	0,800	50
1 2060 112 026	1"	26,5 x 33,0	230	575	1,180	25
1 2060 112 035	1 1/4"	35,5 x 42,0	260	650	1,760	25
1 0621 000 051	2"	51,5 x 60,0	360	850	2,500	15

# LIQUID-TIGHT-FOOD

Metall-Schutzschlauch  
Stahl verzinkt  
PU-Mantel  
flüssigkeitsdicht und lebensmittelecht

Protective metal conduit  
galvanized steel  
PU sheathing  
liquid tight and food-safe



IP 68 | IP 69K  
-40°C ... +80°C ^ +110°C

## KONSTRUKTION

wendelgewickelt  
eingehaktes Profil  
Spezialfaden-Dichtung  
glatter, lebensmittelechter PU-Mantel

## STRUCTURE

strip-wound  
hooked profile  
special fibre sealing  
smooth, food-safe PU sheathing

**ECOLAB**

FDA CFR 21 konform | compliant



## MATERIAL

**Schutzschlauch:** Kaltband DC 03/04  
nach EN 10139, verzinkt, Fe/Zn 3  
mit Spezialfaden-Dichtung  
**Mantel:** PU

## MATERIAL

**Conduit:** cold strip, DC 03/04  
acc. to EN 10139, galvanized, Fe/Zn 3  
with special fibre sealing  
**Sheathing:** PU

Passende Verschraubung  
Suitable connector



US-FOOD-M 08.28 IP 68 | IP 69K

## EIGENSCHAFTEN

- lebensmittelecht
- besonders flüssigkeitsdicht
- weitgehend säure- und benzinbeständig
- erhöht ölbeständig
- halogen-, silikon- und cadmiumfrei
- mikrobenbeständig
- flexibel
- UV-beständig
- selbstverlöschend

## PROPERTIES

- food-safe
- extremely liquid-tight
- widely resistant to acid and petrol
- highly oil-resistant
- free of halogen silicone, cadmium
- microbe resistant
- flexible
- UV resistant
- self-extinguishing

## ANWENDUNGSGEBIETE

- Lebensmittelindustrie
- Automation
- Elektroanlagen
- Maschinen- und Anlagenbau
- für internationale Anforderungen

## APPLICATION

- food and beverage industry
- automotive
- electrical installations
- machine and plant constructions
- for international applications



FLEXA No.

AD  
OD



blau blue

ø

mm

stat

dyn

kg|m

m



1 2083 914 016	1/2"	16,0 x 21,0	105	260	0,300	50
1 2083 914 021	3/4"	21,0 x 26,5	175	430	0,460	50
1 2083 914 026	1"	26,5 x 33,0	200	500	0,650	25
1 2083 914 035	1 1/4"	35,5 x 42,0	240	600	1,000	25

# 06

## KUNSTSTOFFSCHUTZSCHLÄUCHE PROTECTIVE PLASTIC CONDUITS



### PASSENDE VERSCHRAUBUNGEN APPROPRIATE CONNECTORS



Lebensmittelindustrie  
Food and beverage



									
	USK-M US-P	LKI-M LKI-P	US-M US-P	US- FOOD-M	US2-M	USDR-M	USZ-M	USW-M USW-P	NIMS-M NIMS-P
AIRflex®-KUW-PVC-AS	✓	✓	✓					✓	✓
AIRflex®-KUW-PU-AS	✓	✓	✓					✓	✓
AIRflex®-KUW-EDU			✓		✓	✓	✓	✓	
AIRflex®-K	✓	✓	✓					✓	
AIRflex®-GRS	✓	✓	✓						
AIRflex®-GRS-FOOD				✓					
K-Schlauch									✓
K-EDU									✓

**AIRflex® – KUW – PVC – AS**  
PVC  
Federstahldrahtwendel  
PVC  
inside spiral of spring steel wire

06.2



**AIRflex® – KUW – PU – AS**  
PU  
Federstahldrahtwendel  
PU  
inside spiral of spring steel wire

06.3



**AIRflex® – KUW – EDU**  
Federstahldrahtwendel  
PVC-Mantel  
Stahldrahtumflechtung  
Spring steel wire  
PVC sheathing  
galvanized steel wire braiding

06.4



**AIRflex® – K**  
PVC  
integrierter Hartkunststoffwendel  
innen glatt  
PVC  
integrated spiral of rigid plastic  
plain, inside surface

06.5



**AIRflex® – GRS**  
PVC  
integrierter Hartkunststoffwendel  
innen und außen glatt  
PVC  
integrated spiral of rigid plastic  
plain inside and outside surfaces

06.6



**AIRflex® – GRS – FOOD**  
PVC, lebensmittelecht  
integrierter Hartkunststoffwendel  
innen und außen glatt  
PVC, food-safe  
integrated spiral of rigid plastic  
plain inside and outside surfaces

06.7

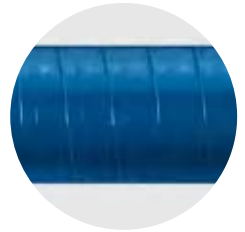

**K – Schlauch**  
PVC  
PVC

06.8

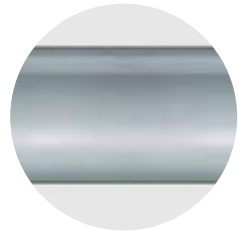

**K – EDU**  
PVC mit Stahldrahtumflechtung  
PVC with steel wire braiding

06.9

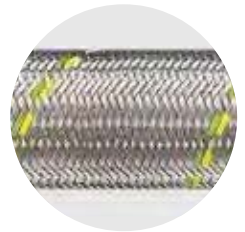

IP 68  
-25°C ... +90°C ^ +100°C

EN / IEC 61386-23



UL 1696  
UR file E86359



Passende Verschraubungen  
Suitable connectors

Seite | page

	USK-M P	08.26	IP 54
	LKI-M P	08.27	IP 54
	US-M	08. 2- 4	IP 54
	US-P	08. 5- 7	IP 54
	USW-M	08.22-23	IP 54
	USW-P	08.24-25	IP 54

# AIRflex® – KUW – PVC – AS

Kunststoff-Schutzschlauch  
Sonderfarben auf Anfrage

Protective plastic conduit  
Special colours on request

## KONSTRUKTION

wendelgewellt, kunststoffummantelter  
Federstahldrahtwendel  
fixierter Weich-PVC-Mantel

## STRUCTURE

helical coiled  
spiral of PVC sheathed spring steel wire  
fixed soft PVC sheathing

## MATERIAL

Außenmantel: PVC  
Innenwendel:  
PVC-ummantelter Federstahldraht

## MATERIAL

Sheathing: PVC  
Inside spiral:  
PVC sheathed spring steel wire

## EIGENSCHAFTEN

- hochflexibel
- dehn- und stauchbar
- luft- und flüssigkeitsdicht
- weitgehend säure- und ölbeständig
- silikon- und cadmiumfrei
- innerer Korrosionsschutz
- geprüft nach DIN EN ICE 61386-23

## PROPERTIES

- extremely flexible
- expansible and upsettable
- airtight and liquid tight
- widely resistant to oil and acids
- free of silicone and cadmium
- inside protection against corrosion
- approved acc. to DIN EN ICE 61386-23

## ANWENDUNGSGEBIETE

- Maschinen- und Anlagenbau
- Fahrzeugbau
- Schiffsbau
- Automation
- Elektroanlagen
- Einsatz in Führungsketten
- als Saugschlauch geeignet

## APPLICATION

- machine and plant constructions
- automotive
- shipbuilding
- automation
- electrical installations
- applications with guide chains
- suitable as suction conduit



FLEXA No.

AD  
OD



grau grey

ø

mm

stat

dyn

kg/m

m



1 2030 101 007	10	7,0 x 10,0	8	20	0,041	50
1 2030 101 010*	14	10,0 x 14,0	10	25	0,076	50
1 2030 101 013*	17	13,0 x 17,0	13	35	0,103	50
1 2030 101 015*	19	15,0 x 19,0	15	40	0,120	50
1 2030 101 016*	21	16,0 x 21,0	17	45	0,170	50
1 2030 101 021	27	22,0 x 27,0	20	50	0,300	50
1 2030 101 029	36	29,0 x 36,0	25	65	0,420	25
1 2030 101 038	45	38,0 x 45,0	36	90	0,520	25
1 2030 101 048	56	48,0 x 56,0	40	100	0,800	25

Verkaufsverpackung 10 m | 10 m sales pack

1 2031 101 007	10	7,0 x 10,0	8	20	0,041	10
1 2031 101 010*	14	10,0 x 14,0	10	25	0,076	10
1 2031 101 013*	17	13,0 x 17,0	13	35	0,103	10
1 2031 101 015*	19	15,0 x 19,0	15	40	0,120	10
1 2031 101 016*	21	16,0 x 21,0	17	45	0,170	10
1 2031 101 021	27	22,0 x 27,0	20	50	0,300	10
1 2031 101 029	36	29,0 x 36,0	25	65	0,420	10
1 2031 101 038	45	38,0 x 45,0	36	90	0,520	10
1 2031 101 048	56	48,0 x 56,0	40	100	0,800	10

\* mit NEMKO-Approbation with NEMKO approval

# AIRflex® – KUW – PU – AS

Kunststoff-Schutzschlauch

Protective plastic conduit

## KONSTRUKTION

wendelgewellt, innenliegender kunststoffummantelter Federstahldrahtwendel, fixierter PU-Mantel

## STRUCTURE

helical coiled, inside spiral of plastic-sheathed spring steel wire fixed PU sheathing

## MATERIAL

Außenmantel: Polyurethan [PU]  
Innenwendel: Kunststoff|Federstahldraht

## MATERIAL

Sheathing: polyurethane [PU]  
Inside spiral: plastic|spring steel wire

## EIGENSCHAFTEN

- V2 nach UL 94
- hochflexibel
- dehn- und stauchbar
- luft- und flüssigkeitsdicht
- hohe Zähigkeit und Abriebbeständigkeit
- öl-, benzin-, und fettbeständig
- weitgehend lösungsmittel-|säurebeständig
- halogen-, silikon-, cadmiumfrei
- mikrobebeständig
- gutes Verhalten bei tiefen Temperaturen
- flammgeschützt
- geprüft nach DIN EN ICE 61386-23

## PROPERTIES

- V2 according to UL 94
- extremely flexible
- highly expansible and upsettable
- airtight and liquid tight
- high tenacity | abrasion resistance
- resistant to oil, benzine and grease
- widely resistant to solvents and acids
- free of halogen, silicone, cadmium
- microbe resistant
- good performance at low temperatures
- flame-resistant
- approved acc. to DIN EN ICE 61386-23

## ANWENDUNGSGEBIETE

- Maschinen- und Anlagenbau
- Fahrzeugbau
- Schiffsbau
- Automation
- Elektroanlagen
- Einsatz in Führungsketten
- als Saugschlauch geeignet

## APPLICATION

- machine and plant constructions
- automotive
- shipbuilding
- automation
- electrical installations
- applications with guide chains
- suitable as suction conduit

IP 68  
-40°C ... +100°C ^ +120°C

EN / IEC 61386-23



Passende Verschraubungen  
Suitable connectors

Seite | page

		Seite   page	IP
	USK-M -P	08.26	IP 54
	LKI-M -P	08.27	IP 54
	US-M	08. 2 - 4	IP 54
	US-P	08. 5 - 7	
	USW-M	08.22 - 23	IP 54
	USW-P	08.24 - 25	



FLEXA No.

AD  
OD



mm



stat dyn



kg/m



m

metallic blau metallic blue



1 2040 701 007	10	7,0 x 10,0	8	20	0,038	50
1 2040 701 010	14	10,0 x 14,0	10	25	0,085	50
1 2040 701 013	17	13,0 x 17,0	13	35	0,116	50
1 2040 701 015	19	15,0 x 19,0	15	40	0,119	50
1 2040 701 016	21	16,0 x 21,0	17	45	0,160	50
1 2040 701 021	27	22,0 x 27,0	20	50	0,260	50
1 2040 701 029	36	29,0 x 36,0	25	65	0,420	25
1 2040 701 038	45	38,0 x 45,0	36	90	0,500	25
1 2040 701 048	56	48,0 x 56,0	40	100	0,820	25

Verkaufsverpackung 10 m | 10 m sales pack

1 2041 701 007	10	7,0 x 10,0	8	20	0,038	10
1 2041 701 010	14	10,0 x 14,0	10	25	0,085	10
1 2041 701 013	17	13,0 x 17,0	13	35	0,116	10
1 2041 701 015	19	15,0 x 19,0	15	40	0,119	10
1 2041 701 016	21	16,0 x 21,0	17	45	0,160	10
1 2041 701 021	27	22,0 x 27,0	20	50	0,260	10
1 2041 701 029	36	29,0 x 36,0	25	65	0,420	10
1 2041 701 038	45	38,0 x 45,0	36	90	0,500	10
1 2041 701 048	56	48,0 x 56,0	40	100	0,820	10

IP 68  
 -25°C ... +90°C ^ +100°C



Passende Verschraubungen  
 Suitable connectors

		Seite   page	◆
	US-M	08. 2- 4	IP 54
	US-P	08. 5- 7	IP 54
	US2-M	08. 8	IP 54
	USDR-M	08.10	IP 54
	USZ-M	08.12	IP 54
	USW-M	08.22-23	IP 54
	USW-P	08.24-25	IP 54

# AIRflex® – KUW – EDU

Kunststoff-Schutzschlauch  
 verzinkte Stahldrahtumflechtung

Protective plastic conduit  
 galvanized steel wire braiding

## KONSTRUKTION

wendelgewellt, kunststoffummantelter  
 Federstahldrahtwendel, Weich-PVC-Mantel,  
 verzinkte Stahldrahtumflechtung

## STRUCTURE

helical coiled, spiral of PVC sheathed  
 spring steel wire, soft PVC sheathing,  
 galvanized steel wire braiding

## MATERIAL

Schutzschlauch: PVC-Außenmantel  
 Innenwendel: Federstahldraht  
 Umflechtung: verzinkter Stahldraht

## MATERIAL

Conduit: PVC sheathing  
 Inside spiral: spring steel wire  
 Braiding: galvanized steel wire

## EIGENSCHAFTEN

- sehr flexibel
- luft- und flüssigkeitsdicht
- zug- und verdrehfest
- weitgehend öl- und säurebeständig
- silikon- und cadmiumfrei
- erhöhte Innendruck-Beständigkeit
- Schutz gegen heiße Späne
- Abschirmung

## PROPERTIES

- very flexible
- airtight and liquid tight
- resistant to stretch and twist
- widely resistant to oil and acids
- free of silicone and cadmium
- high resistance to internal compression
- protection against hot swarfs
- shielding factor

## ANWENDUNGSGEBIETE

- Maschinen- und Anlagenbau  
 Spritzgussmaschinen  
 Zerspanungsmaschinen
- Fahrzeugbau
- Automation
- Elektroanlagen

## APPLICATION

- machine and plant constructions  
 injection moulding machines  
 metal cutting machines
- automotive
- automation
- electrical installations

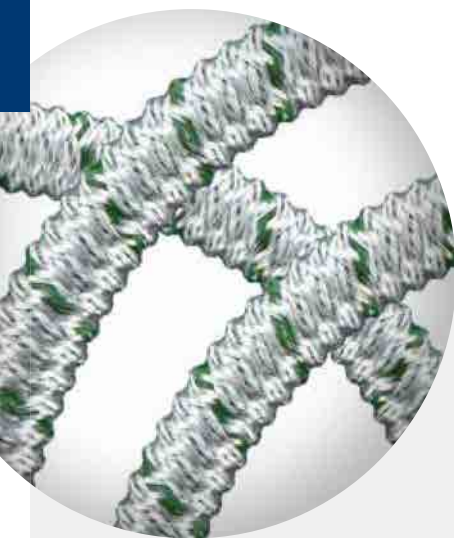

FLEXA No.

AD  
 OD



ø

mm



stat

dyn



kg|m



m



1 4230 101 009	14	9,0 x 14,0	16	40	0,150	50
1 4230 101 012	17	12,0 x 17,0	19	50	0,210	50
1 4230 101 015	21	15,0 x 21,0	24	60	0,280	50
1 4230 101 020	27	20,0 x 27,0	30	75	0,380	50
1 4230 101 028	36	28,0 x 36,0	40	100	0,620	25
1 4230 101 037	45	37,0 x 45,0	48	120	0,820	25
1 4230 101 048	56	48,0 x 56,0	60	150	1,040	25

Verkaufsverpackung 10 m | 10 m sales pack

1 4231 101 009	14	9,0 x 14,0	16	40	0,150	10
1 4231 101 012	17	12,0 x 17,0	19	50	0,210	10
1 4231 101 015	21	15,0 x 21,0	24	60	0,280	10
1 4231 101 020	27	20,0 x 27,0	30	75	0,380	10
1 4231 101 028	36	28,0 x 36,0	40	100	0,620	10
1 4231 101 037	45	37,0 x 45,0	48	120	0,820	10**
1 4231 101 048	56	48,0 x 56,0	60	150	1,040	10**

\*\* in Ringen | in rings



# AIRflex®-K

Vollkunststoff-Schutzschlauch  
innen glatt  
UL-File-Nr. E 86359  
Underwriters' Laboratories Inc.

Protective all-plastic conduit  
plain inside surface  
UL File No. E 86359  
Underwriters' Laboratories Inc.

## KONSTRUKTION

wendelgewickelt, innen glatt  
integrierter Hartkunststoffwendel

## STRUCTURE

strip-wound, plain inside surface  
integrated helix of rigid plastic

## MATERIAL

PVC mit Hartkunststoffwendel

## MATERIAL

PVC with helix of rigid plastic

## EIGENSCHAFTEN

- V0 nach UL 94
- sehr flexibel
- luft- und flüssigkeitsdicht
- weitgehend säure- und ölbeständig
- silikon- und cadmiumfrei
- leichtes Einziehen von Kabeln

## PROPERTIES

- V0 according to UL 94
- extremely flexible
- airtight and liquid tight
- widely resistant to oil and acids
- free of silicone and cadmium
- easy drawing-in of cables

## ANWENDUNGSGEBIETE

- Maschinen- und Anlagenbau
- Fahrzeugbau
- Schiffsbau
- Automation
- Elektroanlagen

## APPLICATION

- machine and plant constructions
- automotive
- shipbuilding
- automation
- electrical installations

IP 68  
-25°C ... +70°C ^ +100°C

UL 1696  
UR file E86359  
CSA 22.2  
File No. 227.3-05



Passende Verschraubungen  
Suitable connectors

Seite | page

	USK-M -P	08.26	IP 54
	LKI-M -P	08.27	IP 54
	US-M	08. 2 - 4	IP 54
	US-P	08. 5 - 7	IP 54
	USW-M	08.22 - 23	IP 54
	USW-P	08.24 - 25	IP 54

- \* Montagehinweis:  
Bitte mit Schmiermittel montieren!
- \* Assembly construction:  
Please assemble with lubricant!



FLEXA No.	AD OD					
grau grey	ø	mm	stat	dyn	kg m	m
1 0200 101 007	10	7,0 x 10,0	16	40	0,050	50
1 0200 101 010	14	10,0 x 14,0	18	45	0,070	50
1 0200 101 013	17	13,0 x 17,0	22	55	0,090	50
1 0200 101 015	19	15,0 x 19,0	25	65	0,110	50
1 0200 101 016	21	16,0 x 21,0	30	75	0,120	50
1 0200 101 021	27	21,0 x 27,0	40	100	0,220	50
1 0200 101 029	36	29,0 x 36,0	50	125	0,300	25
1 0200 101 038	45	38,0 x 45,0	60	150	0,380	25
1 0200 101 048	56	48,0 x 56,0	100	250	0,540	25
Verkaufsverpackung 10 m   10 m sales pack						
1 0201 101 007	10	7,0 x 10,0	16	40	0,050	10
1 0201 101 010	14	10,0 x 14,0	18	45	0,070	10
1 0201 101 013	17	13,0 x 17,0	22	55	0,090	10
1 0201 101 015	19	15,0 x 19,0	25	65	0,110	10
1 0201 101 016	21	16,0 x 21,0	30	75	0,120	10
1 0201 101 021	27	21,0 x 27,0	40	100	0,220	10
1 0201 101 029	36	29,0 x 36,0	50	125	0,300	10
1 0201 101 038	45	38,0 x 45,0	60	150	0,380	10**
1 0201 101 048	56	48,0 x 56,0	100	250	0,540	10**

Weitere Abmessungen und Materialien auf Anfrage  
Further dimensions and materials on request

\*\* in Ringen in rings

IP 68  
 -25°C ... +70°C ^ +100°C

UL 1696  
 UR file E86359  
 CSA 22.2  
 File No. 227.3-05



Passende Verschraubungen  
 Suitable connectors

Seite | page

	USK-M -P*	08.26	IP 54
	LKI-M -P*	08.27	IP 54
	US-M	08. 2- 4	IP 65
	US-P	08. 5- 7	
	USW-M	08.22-23	IP 65
	USW-P	08.24-25	

\* Montagehinweis:  
 Bitte mit Schmiermittel montieren!

\* Assembly construction:  
 Please assemble with lubricant!



## AIRflex® – GRS

Vollkunststoff-Schutzschlauch  
 außen und innen glatt  
 UL-File-Nr. E 86359  
 Underwriters' Laboratories Inc.  
 Sonderfarben auf Anfrage

### KONSTRUKTION

innen und außen glatt  
 integrierter Hartkunststoffwendel

### MATERIAL

PVC mit Hartkunststoffwendel

### EIGENSCHAFTEN

- V2 nach UL 94
- flexibel
- luft- und flüssigkeitsdicht
- weitgehend säure- und ölbeständig
- silikon- und cadmiumfrei
- innen und außen glatt, leichtes Einziehen von Kabeln und außen leichtes Reinigen des Schlauches

### ANWENDUNGSGEBIETE

- Maschinen- und Anlagenbau
- Fahrzeugbau
- Schiffsbau
- Automation
- Elektroanlagen

Protective all-plastic conduit  
 plain inside and outside surfaces  
 UL File No. E 86359  
 Underwriters' Laboratories Inc.  
 Special colours on request

### STRUCTURE

plain inside and outside surfaces  
 integrated helix of rigid plastic

### MATERIAL

PVC with helix of rigid plastic

### PROPERTIES

- V2 according to UL 94
- flexible
- airtight and liquid tight
- widely resistant to oil and acids
- free of silicone and cadmium
- plain inside and outside, easy drawing-in of cables and cleaning outside surface of conduits

### APPLICATION

- machine and plant constructions
- automotive
- shipbuilding
- automation
- electrical installations



FLEXA No.

AD  
 OD



grau grey

ø

mm

stat

dyn

kg/m

m

FLEXA No.	ø	mm	stat	dyn	kg/m	m
1 0220 101 010	14	10,0 x 14,0	50	125	0,085	50
1 0220 101 013	17	13,0 x 17,0	65	165	0,120	50
1 0220 101 016	21	16,0 x 21,0	75	190	0,160	50
1 0220 101 021	27	21,0 x 27,0	90	225	0,240	50
1 0220 101 029	36	29,0 x 36,0	130	325	0,400	25
1 0220 101 038	45	38,0 x 45,0	190	475	0,580	25
1 0220 101 048	56	48,0 x 56,0	250	625	0,740	25

# AIRflex® – GRS – FOOD

Vollkunststoff-Schutzschlauch  
 lebensmittelecht  
 außen und innen glatt

Protective all-plastic conduit  
 food-safe  
 plain inside and outside surfaces

## KONSTRUKTION

innen und außen glatt  
 integrierter Hartkunststoffwendel

## STRUCTURE

plain inside and outside surfaces  
 integrated helix of rigid plastic

## MATERIAL

PVC  
 mit Hartkunststoffwendel

## MATERIAL

PVC  
 with helix of rigid plastic

## EIGENSCHAFTEN

- lebensmittelecht
- mikrobebeständig
- flexibel
- luft- und flüssigkeitsdicht
- weitgehend säure- und ölbeständig
- silikon- und cadmiumfrei
- weichmacherfrei
- innen und außen glatt, leichtes Einziehen von Kabeln und außen leichtes Reinigen des Schlauches

## PROPERTIES

- food-safe
- microbe resistant
- flexible
- airtight and liquid tight
- widely resistant to oil and acids
- free of silicone and cadmium
- unplasticized
- plain inside and outside, easy drawing-in of cables and cleaning outside surface of conduits

## ANWENDUNGSGEBIETE

- Lebensmittelindustrie
- Automation
- Elektroanlagen
- Maschinen- und Anlagenbau

## APPLICATION

- food and beverage industry
- automation
- electrical installations
- machine and plant constructions



IP 68 | IP 69K  
 -25°C ... +50°C ^ +70°C

**ECOLAB**

FDA CFR 21 konform | compliant



Passende Verschraubung  
 Suitable connector

Seite | page



US-FOOD-M 08.28 IP 68 | IP 69K



FLEXA No.

AD  
 OD



mm



stat dyn



kg/m



m

blau blue



FLEXA No.	AD OD	mm	stat	dyn	kg/m	m
1 0220 904 016	1/2"	16,0 x 21,0	70	175	0,175	50
1 0220 904 021	3/4"	21,0 x 27,0	85	210	0,240	50
1 0220 904 029	1"	26,2 x 33,0	125	310	0,410	25
1 0220 904 038	1 1/4"	35,0 x 42,0	160	400	0,530	25

IP 68  
 -25°C ... +90°C ^ +100°C



Passende Verschraubung  
 Suitable connector

Seite | page

	NIMS-M P	08.32	IP 68
	SGL	08.32	

# K-Schlauch

Vollkunststoff-Schutzschlauch

Protective all-plastic conduit

## KONSTRUKTION

innen und außen glatt

## STRUCTURE

plain inside and outside surfaces

## MATERIAL

PVC

## MATERIAL

PVC

## EIGENSCHAFTEN

- flexibel
- luft- und flüssigkeitsdicht
- weitgehend säure- und ölbeständig
- silikon- und cadmiumfrei
- innen und außen glatt

## PROPERTIES

- flexible
- airtight and liquid tight
- widely resistant to oil and acids
- free of silicone and cadmium
- plain inside and outside surface

## ANWENDUNGSGEBIETE

- Maschinen- und Anlagenbau
- Fahrzeugbau
- Automation
- Elektroanlagen

## APPLICATION

- machine and plant constructions
- automotive
- automation
- electrical installations



FLEXA No.

AD  
OD



grau grey

ø

mm

mm

kg/m

m

FLEXA No.	AD OD	mm	mm	kg/m	m
1 0205 101 007	10	7,0 x 9,0	je nach Füllungsgrad des Schlauches depending on filling ratio of the conduit	0,040	50
1 0205 101 011	14	10,5 x 13,5		0,072	50
1 0205 101 014	17	13,5 x 16,5		0,100	50
1 0205 101 015	19	15,0 x 18,4		0,130	50
1 0205 101 017	21	17,0 x 20,5		0,140	50
1 0205 101 022	27	22,0 x 26,5		0,300	50
1 0205 101 030	36	29,5 x 35,0		0,420	25
1 0205 101 038	45	38,0 x 44,0		0,540	25

# K-EDU

Kunststoff-Schutzschlauch  
verzinkte Stahldrahtumflechtung

Protective plastic conduit  
galvanized steel wire braiding

## KONSTRUKTION

innen glatt  
verzinkte Stahldrahtumflechtung

## STRUCTURE

plain inside surface  
galvanized steel wire braiding

## MATERIAL

Schlauch: PVC  
Umflechtung: verzinkter Stahldraht

## MATERIAL

Conduit: PVC  
Braiding: galvanized steel wire

## EIGENSCHAFTEN

- flexibel
- luft- und flüssigkeitsdicht
- weitgehend ölbeständig
- silikon- und cadmiumfrei
- erhöhte Innendruck-Beständigkeit
- Abschirmung sowie Schutz vor heißen Spänen
- innen glatt

## PROPERTIES

- flexible
- airtight and liquid tight
- widely resistant to oil and acids
- free of silicone and cadmium
- constancy for raised internal pressure
- shielding as well as protection against hot swarfs
- smooth inside surface

## ANWENDUNGSGEBIETE

- Maschinen- und Anlagenbau  
Spritzgussmaschinen  
Zerspanungsmaschinen
- Fahrzeugbau
- Schiffsbau
- Automation
- Elektroanlagen

## APPLICATION

- machine and plant constructions  
injection moulding machines  
metal cutting machines
- automotive
- shipbuilding
- automation
- electrical installations

## WICHTIG

Messingdruckring erforderlich

## IMPORTANT

Brass thrust collar necessary

IP 68  
-25°C ... +90°C ^ +100°C



Passende Verschraubung  
Suitable connector

Seite | page

	NIMS-M P	08.32	IP 68
	SGL	08.32	

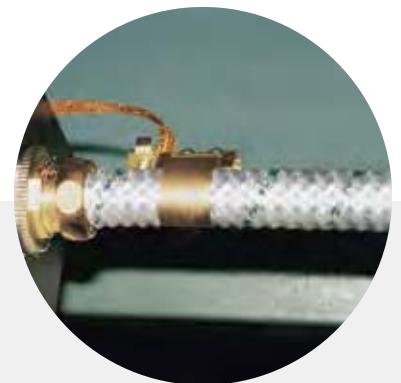
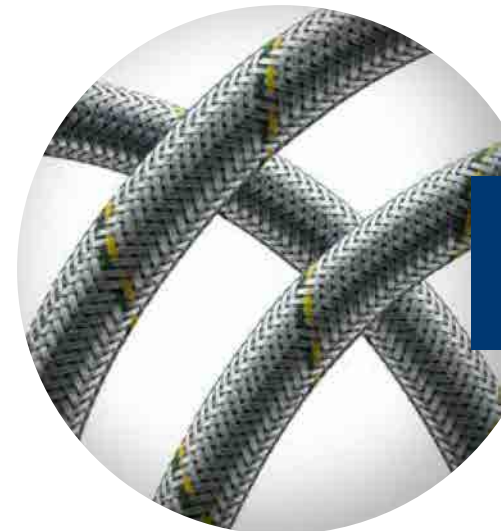

FLEXA No.

AD  
OD



mm



mm ±10%



kg/m



m

FLEXA No.	AD OD	mm	mm ±10%	kg/m	m
1 4020 101 006	10	6,0 x 10,0	je nach Füllungsgrad des Schlauches depending on filling ratio of the conduit	0,100	50
1 4020 101 009	14	9,0 x 14,0		0,150	50
1 4020 101 012	17	12,0 x 17,0		0,090	50
1 4020 101 014	19	14,0 x 19,0		0,230	50
1 4020 101 016	21	16,0 x 21,0		0,250	50
1 4020 101 021	27	21,0 x 27,0		0,400	50
1 4020 101 028	36	28,0 x 36,0		0,580	25

# 07

## SPEZIALSCHUTZSCHLÄUCHE SPECIAL PROTECTIVE CONDUITS



### PASSENDE VERSCHRAUBUNGEN APPROPRIATE CONNECTORS



Schienefahrzeugindustrie  
Railway Technology



EMV-Anwendungen  
EMC Applications



Sensortechnik  
Sensor Technology



US-M  
US-P



NIMS-M  
NIMS-P

HG-CU | HG-CU-F

✓

HG-CU-K

✓

FLEXAhightemp

✓

✓

**HG – PA**

Geflechtschlauch aus  
Polyamid-Monofil  
Rundgeflecht  
Wire braiding made of  
polyamide monofil  
round braiding

07. 2



**HG – PET022**

Geflechtschlauch aus  
PET-Monofil,  
Rundgeflecht  
Wire braiding made of  
PET monofil  
round braiding

07. 3

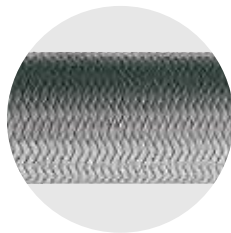

**HG – CU | HG – CU – F**

Geflechtschlauch aus  
verzinneten Kupferdrähten  
Rundgeflecht  
Wire braiding made of  
tinned copper  
round braiding

07. 4



**HG – CU – K**

Geflechtschlauch aus  
verzinneten Kupferdrähten  
auf PVC Trägerschlauch  
Rundgeflecht  
EMV Schutz  
Wire braiding made of tinned  
copper on a PVC tube former  
round braiding  
EMC protection

07. 5

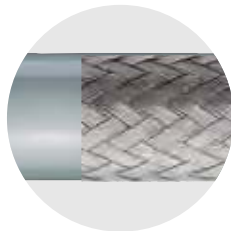

**HG – EDU**

Geflechtschlauch aus  
verzinkten Stahldrähten  
Rundgeflecht  
Wire braiding made of  
galvanized steel wires  
round braiding

07. 6



**FDW – VA**

Flachdrahtwendel  
Edelstahl  
Flat helix  
Stainless steel

07. 7

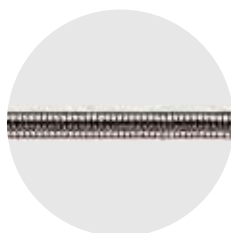

**SPR – VA – PVC**

Metall-Schutzschlauch  
Edelstahl  
S Profil, PVC Mantel  
Protective metal conduit  
stainless steel  
S profile, PVC sheathing

07. 8

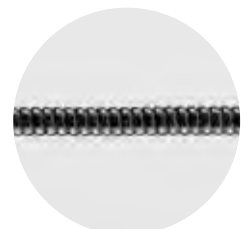

**SPR – PVC – ESD**

Metall-Schutzschlauch  
Stahl verzinkt  
S Profil, PVC Mantel  
Protective metal conduit  
Galvanized steel  
S profile, PVC sheathing

07. 9

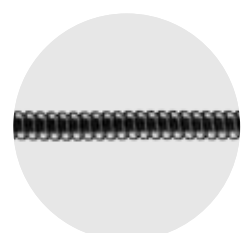

**SPR – VA – PU**

Metall-Schutzschlauch  
Edelstahl, S Profil  
PU Mantel  
Protective metal conduit  
Stainless steel  
S profile, PU sheathing

07.10

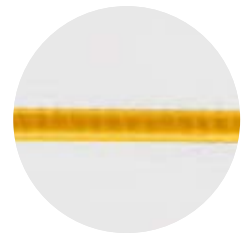

**PS – VA | PSL – VA**

Edelstahlwendel  
Glasseidenumflechtung  
Silikon-Kautschukmantel  
Helix made of stainless steel  
fiber glass braiding  
silicone-rubber sheathing

07.11

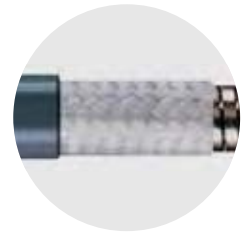

**FLEXAspiral**

Wickel- und Bündelungsspiralen  
aus PA 12 oder PE  
Spiral bindings  
made of PA 12 or PE

07.12

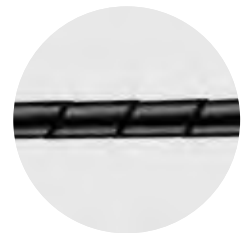

**FLEXAhightemp**

Feuerschutzschlauch  
Calciumsilikat-Geflecht  
Silikon-Mantel  
Fire protection conduit  
calcium-silicate-braiding  
silicone sheathing

07.14





V2 [UL 94]

-50°C ... +120°C ^ 150°C

Bedeckung | Coverage > 85%



## HG-PA

Geflechtschlauch  
aus Polyamid-Monofilien

### KONSTRUKTION

Geflecht aus rund geflochtenen  
Monofilien mit doppelter Kreuzung  
in den verschiedenen Flechtwinkeln

### MATERIAL

Polyamid 6.6 Monofile  
Durchmesser 0,25 mm  
Andere Werkstoffe und aus Polyamid  
hitzebestabilisiert auf Anfrage

### EIGENSCHAFTEN

- V2 nach UL 94
- axial aufstauchbar in einem bestimmten Verhältnis, je nach Geflechtkonstruktion
- leichtes Einziehen von Kabeln etc.
- durch Strecken stramm aufzubringen
- öl- und benzinbeständig
- weitgehend säure- und lösungsmittelbeständig
- halogenfrei
- selbstverlöschend und flammwidrig

### ANWENDUNGSGEBIETE

- Kabelbündelung
- Maschinen- und Anlagenbau
- Fahrzeugbau
- Schienenfahrzeuge
- Schiffsbau
- Automation
- Elektroanlagen

Wire braiding  
made of polyamide monofilaments

### STRUCTURE

Braiding consisting of round braided  
monofilaments with double crossed  
looping at the different braiding angles

### MATERIAL



round polyamide 6.6 monofilaments  
diameter 0.25 mm  
Further materials like heat-resistant  
polyamide on request

### PROPERTIES

- V2 according to UL 94
- axially pushed together, in a certain proportion, depending the construction of the braiding
- easy pulling in of cables
- the braiding becomes tight by stretching
- oil- and benzine-resistant
- widely resistant to solvents and acids
- free of halogen
- self-extinguishing and flame-resistant

### APPLICATION

- cable bundling
- machine and plant constructions
- automotive
- railway industry
- shipbuilding
- automation
- electrical installations

FLEXA No.	NW ID	Bedeckung Coverage	Einsatzbereich Operative range		 kg m	 m
			min ø mm	max ø mm		
schwarz black	ø	mm				
1 0239 202 010	5	95	4,0	10,0	0,008	100
1 0239 202 014	10	89	7,0	14,0	0,014	100
1 0239 202 022	14	85	10,0	22,0	0,014	100
1 0239 202 027	20	83	18,0	27,0	0,017	100
1 0239 202 034	25	85	18,0	34,0	0,026	100
1 0239 202 042	30	93	28,0	42,0	0,038	50
1 0239 202 080	50	88	35,0	80,0	0,057	50



# HG – PET022

Geflechtschlauch  
aus PET-Monofilien

Wire braiding  
made of PET monofilas



🔥 -50°C ... +150°C ^ +175°C  
Bedeckung | Coverage > 85%

## KONSTRUKTION

Geflecht aus rund geflochtenen  
Monofilien mit doppelter Kreuzung in  
den verschiedenen Flechtwinkeln

## STRUCTURE

Braiding consisting of round braided  
monofilas with double crossed  
looping at the different braiding angles

## MATERIAL

PET-Monofile  
Durchmesser 0,22 mm

## MATERIAL

round PET monofilas  
diameter 0.22 mm



## EIGENSCHAFTEN

- leichtes Einziehen von Kabeln  
auch über große Längen
- abriebfest
- silikon-, cadmium- und halogenfrei
- Beständigkeit gegen Benzin  
und Mineralöle
- selbstverlöschend
- UV-beständig

## PROPERTIES

- easy pulling in of cables  
even in case of long distances
- resistant to abrasion
- free of silicone | cadmium | halogen
- resistance of fuel and  
mineral oils
- self-extinguishing
- UV resistant



## ANWENDUNGSGEBIETE

- Kabelbündelung
- Maschinen- und Anlagenbau
- Fahrzeugbau
- Schienenfahrzeuge
- Schiffsbau
- Automation
- Elektroanlagen

## APPLICATION

- cable bundling
- machine and plant constructions
- automotive
- railway industry
- shipbuilding
- automation
- electrical installations



FLEXA No.		NW ID	Bedeckung Coverage	Einsatzbereich Operative range			
schwarz black	grau grey	ø	mm	min ø mm	max ø mm	kg/m	m
1 0239 602 008	1 0239 601 008	4	85	4,0	8,0	0,006	200
1 0239 602 011	1 0239 601 011	5	89	3,0	11,0	0,007	200
1 0239 602 014	1 0239 601 014	8	81	6,0	14,0	0,010	150
1 0239 602 020	1 0239 601 020	10	79	8,0	20,0	0,012	150
1 0239 602 025	1 0239 601 025	15	81	13,0	25,0	0,013	100
1 0239 602 030	1 0239 601 030	18	71	15,0	30,0	0,015	100
1 0239 602 038	1 0239 601 038	25	82	28,0	38,0	0,024	100
1 0239 602 050	1 0239 601 050	30	73	23,0	50,0	0,034	100
1 0239 602 060	1 0239 601 060	36	75	34,0	60,0	0,042	100
1 0239 602 080	1 0239 601 080	50	78	45,0	80,0	0,051	50
Spenderbox   Dispenser box							<b>Box</b>
1 0239 692 011		5	89	3,0	10,0	0,007	15
1 0239 692 014		8	81	6,0	14,0	0,010	12
1 0239 692 020		10	79	8,0	20,0	0,012	12
1 0239 692 025		15	81	13,0	25,0	0,013	6
1 0239 692 050		30	73	23,0	50,0	0,034	6





**-50°C ... +250°C**  
Bedeckung | Coverage > 85%



Passende Anschlüsse  
Suitable connectors

Seite | page

	NIMS-M	08.32
	SGL	08.32



## HG-CU | HG-CU-F

Geflechtschlauch  
aus verzinneten Kupferdrähten

Wire braiding  
made of tinned copper

### KONSTRUKTION

Geflecht aus rund geflochtenen  
Drähten mit doppelter Kreuzung  
in den verschiedenen Flechtwinkeln

### STRUCTURE

Braiding consisting of round braided  
wires with double crossed looping at  
the different braiding angles

### MATERIAL

verzinnter Kupferdraht  
Andere Werkstoffe auf Anfrage

### MATERIAL

tinned copper wire  
Other materials on request

### EIGENSCHAFTEN

- axial aufstauchbar in einem bestimmten Verhältnis, je nach Geflechtkonstruktion, bis zum 2-fachen Durchmesser
- leichtes Einziehen von Kabeln
- durch Strecken stramm aufzubringen
- Schutz vor heißen Spänen
- gute Abschirmeigenschaften
- Abschirmfaktor bis 30 MHz nach EN 50289-1-6 bis zu 80 dB

### PROPERTIES

- axially pushed together, in a certain proportion, depending upon the construction of the braiding up to the double diameter
- easy pulling in of cables
- the braiding becomes tight by stretching
- protection from hot swarfs
- high shielding factor
- screening factor up to 30 MHz acc. to EN 50289-1-6 up to 80 dB

### ANWENDUNGSGEBIETE

- Kabelbündelung
- Maschinen- und Anlagenbau
- Fahrzeugbau
- Schienenfahrzeugbau
- Schiffsbau
- Automation
- Elektroanlagen
- EMV-Anwendungen

### APPLICATION

- cable bundling
- machine and plant constructions
- automotive
- railway industry
- shipbuilding
- automation
- electrical installations
- EMC applications



FLEXA No.	NW ID	Aufbau Wiring	Querschnitt Cross section	Einsatzbereich Operative range			
			mm <sup>2</sup>	min ø mm	max ø mm	kg/m	m
<b>HG-CU</b>							
	ø	mm					
1 4050 701 008	6	24 x 6 x 0,25	7,07	5,0	12,0	0,060	100
1 4050 701 013	10	32 x 7 x 0,25	11,00	8,0	17,0	0,104	50
1 4050 701 017	15	32 x 7 x 0,25	11,00	12,0	22,0	0,098	50
1 4050 701 025	20	48 x 8 x 0,25	18,85	16,0	27,0	0,190	50
1 4050 701 040	25	48 x 8 x 0,25	18,85	20,0	35,0	0,204	25
1 4050 701 055	35	48 x 10 x 0,25	23,56	25,0	45,0	0,240	25
Verkaufspackung 10 m   10 m sales pack							
1 4050 701 108	6	24 x 6 x 0,25	7,07	5,0	12,0	0,060	10
1 4050 701 113	10	32 x 7 x 0,25	11,00	8,0	17,0	0,104	10
1 4050 701 117	15	32 x 7 x 0,25	11,00	12,0	22,0	0,098	10
1 4050 701 125	20	48 x 8 x 0,25	18,85	16,0	27,0	0,190	10
1 4050 701 140	25	48 x 8 x 0,25	18,85	20,0	35,0	0,204	10
1 4050 701 155	35	48 x 10 x 0,25	23,56	25,0	45,0	0,240	10
<b>HG-CU-F</b> mit feinen Kupferdrähten   with fine tinned copper wires							
1 4050 702 004	4	24 x 6 x 0,15	2,54	4,0	8,0	0,020	100
1 4050 702 006	6	24 x 8 x 0,15	3,39	6,0	12,0	0,030	100
1 4050 702 010	10	24 x 10 x 0,15	4,24	8,0	16,0	0,038	100
1 4050 702 015	15	24 x 10 x 0,15	4,24	10,0	20,0	0,038	100
1 4050 702 020	20	48 x 8 x 0,15	6,79	15,0	30,0	0,060	100
1 4050 702 025	25	48 x 12 x 0,15	10,18	19,0	38,0	0,092	100
1 4050 702 030	30	48 x 15 x 0,15	12,72	24,0	48,0	0,111	100
1 4050 702 040	40	48 x 20 x 0,15	16,96	32,0	64,0	0,152	100

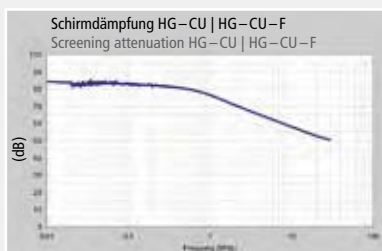

# HG-CU-K

Geflechtschlauch  
aus verzinnnten Kupferdrähten  
mit PVC Trägerschlauch

## KONSTRUKTION

Geflecht aus rund geflochtenen  
Drähten mit doppelter Kreuzung in  
den verschiedenen Flechtwinkeln

## MATERIAL

verzinnnter Kupferdraht  
PVC Trägerschlauch

## EIGENSCHAFTEN

- axial aufstauchbar in einem bestimmten Verhältnis, je nach Geflechtkonstruktion, bis zum 2-fachen Durchmesser
- leichtes Einziehen von Kabeln - der Trägerschlauch kann als Einzugshilfe verwendet werden
- durch Strecken stramm aufzubringen
- Schutz vor heißen Spänen
- gute Abschirmeigenschaften
- Abschirmfaktor bis 30 MHz nach EN 50289-1-6 bis zu 80 dB

## ANWENDUNGSGEBIETE

- Kabelbündelung
- Maschinen- und Anlagenbau
- Fahrzeugbau
- Schienenfahrzeuge
- Schiffsbau
- Automation
- Elektroanlagen
- EMV-Anwendungen

Wire braiding  
made of tinned copper  
with PVC carrier conduit

## STRUCTURE

Braiding consisting of round braided  
wires with double crossed looping at  
the different braiding angles

## MATERIAL

tinned copper wire  
PVC carrier conduit

## PROPERTIES

- axially pushed together, in a certain proportion, depending upon the construction of the braiding up to the double diameter
- easy pulling in of cables - the PVC carrier hose can be used as an insertion tool
- the braiding becomes tight by stretching
- protection from hot swarfs
- high shielding factor
- screening factor up to 30 MHz acc. to EN 50289-1-6 up to 80 dB

## APPLICATION

- cable bundling
- machine and plant constructions
- automotive
- railway industry
- shipbuilding
- automation
- electrical installations
- emc applications



-50°C ... +250°C

Bedeckung | Coverage > 85%

EN / IEC 61386-23



Passende Anschlüsse  
Suitable connectors

Seite | page



NIMS-M

08.32



SGL

08.32



### FLEXA No.

NW  
ID

Aufbau  
Wiring

Querschnitt  
Cross section

Einsatzbereich  
Operative range



ø

mm

mm<sup>2</sup>

min ø  
mm

max ø  
mm

kg/m

m

1 4051 701 008	6	24 x 5 x 0,20	3,77	3,0	10,0	0,075	100
1 4051 701 013	10	24 x 6 x 0,20	4,52	8,0	17,0	0,142	100
1 4051 701 017	15	24 x 8 x 0,20	6,03	12,0	22,0	0,178	100
1 4051 701 025	20	32 x 6 x 0,25	9,42	16,0	27,0	0,220	50
1 4051 701 040	25	48 x 7 x 0,25	16,49	20,0	35,0	0,360	25
1 4051 701 055	35	48 x 8 x 0,25	18,85	25,0	45,0	0,400	25

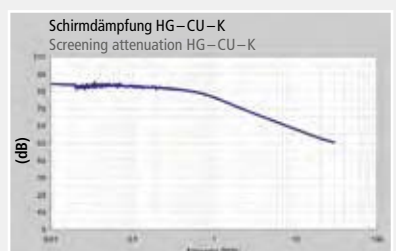

# HG-EDU

-50°C ... +250°C  
Bedeckung | Coverage > 85%



Passende Anschlüsse  
Suitable connectors

Seite | page

	NIMS-M	08.32
	SGL	08.32



Geflechtschlauch  
aus verzinkten Stahldrähten  
Rundgeflecht

Wire braiding  
made of galvanized steel wires  
round braiding

## KONSTRUKTION

Geflecht aus rund geflochtenen  
Drähten mit doppelter Kreuzung  
in den verschiedenen Flechtwinkeln

## STRUCTURE

Braiding consisting of round braided  
wires with double crossed looping  
at the different braiding angles

## MATERIAL

verzinkter Stahldraht  
Weitere Werkstoffe:  
Edelstahldraht  
und andere auf Anfrage

## MATERIAL

galvanized steel wire  
Further materials:  
stainless steel wire  
and further on request

## EIGENSCHAFTEN

- axial aufstauchbar in einem bestimmten Verhältnis, je nach Geflechtkonstruktion
- leichtes Einziehen von Kabeln
- durch Strecken stramm aufzubringen
- Schutz vor heißen Spänen

## PROPERTIES

- axially pushed together, in a certain proportion, depending upon the construction of the braiding
- easy pulling in of cables
- the braiding becomes tight by stretching
- protection from hot swarfs

## ANWENDUNGSGEBIETE

- Kabelbündelung
- Maschinen- und Anlagenbau  
Spritzgussmaschinen  
Zerspanungsmaschinen
- Fahrzeugbau
- Schiffsbau
- Automation
- Elektroanlagen

## APPLICATION

- cable bundling
- machine and plant constructions  
injection moulding machines  
metal cutting machines
- automotive
- shipbuilding
- automation
- electrical installations



FLEXA No.	NW ID	Aufbau Wiring	Querschnitt Cross section	Einsatzbereich Operative range		kg/m	m
	ø	mm	mm <sup>2</sup>	min ø mm	max ø mm		
1 4050 101 008	6	36 x 4 x 0,24	6,51	5,0	12,0	0,056	100
1 4050 101 013	10	32 x 7 x 0,24	10,13	8,0	17,0	0,084	50
1 4050 101 017	15	32 x 8 x 0,24	11,58	12,0	22,0	0,098	50
1 4050 101 025	20	48 x 8 x 0,24	17,37	16,0	27,0	0,150	50
1 4050 101 040	25	48 x 8 x 0,24	17,37	20,0	35,0	0,160	25
1 4050 101 055	35	48 x 10 x 0,24	21,71	25,0	45,0	0,202	25
Verkaufspackung 10 m   10 m sales pack							
1 4050 101 108	6	36 x 4 x 0,24	6,51	5,0	12,0	0,056	10
1 4050 101 113	10	32 x 7 x 0,24	10,13	8,0	17,0	0,084	10
1 4050 101 117	15	32 x 8 x 0,24	11,58	12,0	22,0	0,098	10
1 4050 101 125	20	48 x 8 x 0,24	17,37	16,0	27,0	0,150	10
1 4050 101 140	25	48 x 8 x 0,24	17,37	20,0	35,0	0,160	10
1 4050 101 155	35	48 x 10 x 0,24	21,71	25,0	45,0	0,202	10

# FDW-VA

Spezial-Schutzschlauchwendel für Sensor- | Lichtwellenleiter-Technik

## KONSTRUKTION

Edelstahlwendel gewickelt

## MATERIAL

Edelstahl V2A

## EIGENSCHAFTEN

- flexibel
- temperaturbeständig
- weitgehend lösungsmittel- und chemikalienbeständig

## ANWENDUNGSGEBIETE

- Optoelektronik
- Medizintechnik
- Lichtwellenleiter-Technik
- Technische Endoskopie
- Messgeräte
- Sensortechnik

Special protective conduit helix for sensor technology | beam wave guide technology

## STRUCTURE

Helix made of stainless steel

## MATERIAL

stainless steel 304 [AISI]

## PROPERTIES

- flexible
- temperature resistant
- widely resistant to solvents and chemicals

## APPLICATION

- opto-electronics
- medical technology
- beam wave guide technology
- technical endoscopy
- measuring instruments
- sensor technology



-200°C ... +600°C



### FLEXA No.



mm



stat dyn



kg/m



m

auf Kunststoffspule  
on a plastic coil

FLEXA No.	mm	stat	dyn	kg/m	m
1 0131 801 002	2,5 x 3,1	14	35	0,019	50
1 0131 801 003	3,0 x 3,6	20	50	0,029	50
1 0131 801 004	4,0 x 4,8	25	65	0,037	50
1 0131 801 005	5,0 x 6,0	25	65	0,050	50
1 0131 801 006	6,0 x 7,0	35	90	0,065	50
1 0131 801 007	7,0 x 8,2	45	110	0,088	50
1 0131 801 008	8,0 x 9,6	45	110	0,110	50

Lieferzeit und Mindestbestellmenge auf Anfrage Delivery time and minimum order quantity on request



IP 68  
-25°C ... +80°C ^ +100°C



## SPR-VA-PVC

Metall-Schutzschlauch  
Edelstahl  
PVC-Mantel, nicht flammverbreitend  
nach DIN EN IEC 61386-23

Protective metal conduit  
stainless steel  
PVC sheathing, non flame propagating  
acc. to DIN EN IEC 61386-23

### KONSTRUKTION

wendelgewickelt  
S Profil, PVC-Mantel

### STRUCTURE

strip-wound  
S profile, PVC sheathing

### MATERIAL

Schutzschlauch: Edelstahl  
Ummantelung: PVC  
Andere Werkstoffe auf Anfrage

### MATERIAL

Conduit: stainless steel  
Sheathing: PVC  
Further materials on request

### EIGENSCHAFTEN

- wetterfest
- wasserdicht
- weitgehend seewasser-, säure- und ölbeständig
- silikon- und cadmiumfrei
- sehr flexibel
- zugfest
- querdruckbelastbar

### PROPERTIES

- weatherproof
- watertight
- widely resistant to seawater, acids and oils
- free of silicone and cadmium
- very flexible
- stretch-resistant
- compression-resistant

### ANWENDUNGSGEBIETE

- Maschinen- und Anlagenbau
- Fahrzeugbau
- Schiffsbau
- Automation
- Elektroanlagen
- Optoelektronik
- Lichtwellenleiter-Technik
- Technische Endoskopie
- Sensortechnik

### APPLICATION

- machine and plant constructions
- automotive
- shipbuilding
- automation
- electrical installations
- opto-electronics
- beam wave guide technology
- technical endoscopy
- sensor technology



#### FLEXA No.

schwarz black



mm



stat

dyn



m



kg/m



m



1 2010 182 003	3,0 x 6,0	15	37	500	0,040	50
1 2010 182 004	4,0 x 7,0	17	45	500	0,050	50
1 2010 182 005	5,0 x 8,0	20	50	500	0,060	50
1 2010 182 006	6,0 x 9,0	25	60	500	0,080	50
1 2010 182 008	8,0 x 11,0	35	90	500	0,090	50
1 2010 182 009	9,0 x 12,0	38	100	500	0,105	50

Weitere Abmessungen und Farben auf Anfrage Further dimensions and colours on request

# SPR–PVC–ESD

Metall-Schutzschlauch  
 Stahl verzinkt  
 PVC-Mantel, elektrisch ableitfähig  
 spezifischer Oberflächenwiderstand  
 $< 10^6 \Omega$

## KONSTRUKTION

wendelgewickelt  
 S Profil  
 elektrisch ableitfähiger PVC-Mantel

## MATERIAL

Schutzschlauch: Kaltband DC 03/04  
 nach EN 10139, verzinkt, Fe/Zn 3  
 Ummantelung: PVC

## EIGENSCHAFTEN

- wetterfest
- wasserdicht
- weitgehend seewasser-, säure- und ölbeständig
- silikon- und cadmiumfrei
- sehr flexibel
- zugfest
- querdruckbelastbar

## ANWENDUNGSGEBIETE

- Maschinen- und Anlagenbau
- Fahrzeugbau
- Schiffsbau
- Automation
- Elektroanlagen
- Optoelektronik
- Lichtwellenleiter-Technik
- Technische Endoskopie
- Sensortechnik
- Ex-Bereich

Protective metal conduit  
 galvanized steel  
 PVC sheathing, electrically conductive  
 specific surface resistivity  
 $< 10^6 \Omega$

## STRUCTURE

strip-wound  
 S profile  
 electrically conductive PVC sheathing

## MATERIAL

Conduit: cold strip DC 03/04  
 acc. to EN 10139, galvanized, Fe/Zn 3  
 Sheathing: PVC

## PROPERTIES

- weatherproof
- watertight
- widely resistant to seawater, acids and oils
- free of silicone and cadmium
- very flexible
- stretch-resistant
- compression-resistant

## APPLICATION

- machine and plant constructions
- automotive
- shipbuilding
- automation
- electrical installations
- opto-electronics
- beam wave guide technology
- technical endoscopy
- sensor technology
- ex area



IP 68  
 $-25^\circ\text{C} \dots +90^\circ\text{C} \wedge +100^\circ\text{C}$



### FLEXA No.

schwarz black



mm



stat dyn



kg/m



m



1 2010 902 004	4,0 x 7,0	17	45	0,060	50
1 2010 902 005	5,0 x 8,0	20	50	0,062	50
1 2010 902 006	6,0 x 9,0	24	60	0,070	50
1 2010 902 008	8,0 x 11,0	35	90	0,085	50



IP 68  
-40°C ... +80°C ^ +120°C



## SPR-VA-PU

Metall-Schutzschlauch  
PU-Mantel

### KONSTRUKTION

wendelgewickelt  
S Profil  
PU-Mantel

### MATERIAL

Schutzschlauch: Edelstahl  
Ummantelung: PU

### EIGENSCHAFTEN

- sehr gute Abriebfestigkeit
- geringe axiale Streckung
- adhäsionsarme Oberfläche
- silikon-, cadmiumfrei und halogenfrei
- gute Querdrukbelastung
- hohe Mikrobenfestigkeit

### ANWENDUNGSGEBIETE

- Optoelektronik
- Lichtwellenleiter-Technik
- Technische Endoskopie
- Sensortechnik

Protective metal conduit  
PU sheathing

### STRUCTURE

strip-wound  
S profile  
PU sheathing

### MATERIAL

Conduit: stainless steel  
Sheathing: PU

### PROPERTIES

- good abrasion resistance
- low axial elongation
- low adhesion surface
- free of silicone, cadmium and hologen
- good compression resistance
- high microbial resistance

### APPLICATION

- opto-electronics
- beam wave guide technology
- technical endoscopy
- sensor technology



FLEXA No..

gelb yellow



mm

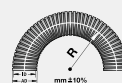

stat dyn



kg|m



m



\* in Fertigungslängen | in production length

1 2010 389 903

3,6 x 6,4

70

180

0,060

\*

Weitere Abmessungen und Farben auf Anfrage Further dimensions and colours on request



# PS-VA | PSL-VA

Spezial-Schutzschlauch für  
Sensor- | Lichtwellenleiter-Technik

Special protective conduit for sensor  
technology | beam wave guide technology



IP 68  
-50°C ... +180°C ^ +200°C

## KONSTRUKTION

Edelstahlwendel gewickelt  
Glasseidenumflechtung  
Silikon-Kautschuk-Ummantelung

## STRUCTURE

Helix made of stainless steel  
fiber glass braiding  
silicone-rubber sheathing

## MATERIAL

Wendel           Edelstahl V2A  
Umflechtung   Glasseide  
Ummantelung   Silikon-Kautschuk

## MATERIAL

Helix            stainless steel 304 [AISI]  
Braiding       fiber glass  
Sheathing      silicone-rubber



Sonderfarben auf Anfrage  
ab 500 m Mindestmenge.  
Special colours on request  
from 500 m on.

## EIGENSCHAFTEN

- flexibel
- zugfest
- luft- und flüssigkeitsdicht
- temperaturbeständig
- schwer entflammbar
- keine Bildung von toxischen und korrosiven Brandgasen
- weitgehend lösungsmittel- und chemikalienbeständig
- halogen- und cadmiumfrei

## PROPERTIES

- flexible
- stretch resistant
- air- and liquid-tight
- temperature resistant
- low flammability
- no appearance of toxic and corrosive fire gases
- widely resistant to solvents and chemicals
- free of halogen and cadmium

## ANWENDUNGSGEBIETE

- Optoelektronik
- Medizintechnik
- Lichtwellenleiter-Technik
- Technische Endoskopie
- Messgeräte
- Sensortechnik

## APPLICATION

- opto-electronics
- medical technology
- beam wave guide technology
- technical endoscopy
- measuring instruments
- sensor technology



FLEXA No.

PS-VA

grau grey



mm

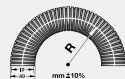

stat    dyn



kg/m



m

FLEXA No.	mm	stat	dyn	kg/m	m
1 0133 900 002	2,5 x 4,4	14	35	0,028	100
1 0133 900 003	3,0 x 5,3	20	50	0,044	100
1 0133 900 013	3,5 x 5,8	20	50	0,050	100
1 0133 900 004	4,0 x 6,5	25	65	0,065	100
1 0133 900 014	4,5 x 7,0	25	65	0,072	50
1 0133 900 005	5,0 x 7,5	25	65	0,079	50
1 0133 900 006	6,0 x 8,9	35	90	0,108	50
1 0133 900 007	7,0 x 10,1	45	110	0,141	50
1 0133 900 008	8,0 x 11,6	45	110	0,191	50

## PSL-VA

1 0133 901 003 *	3,3 x 5,3	10	25	0,030	100
1 0133 901 013 *	3,8 x 5,8	12	30	0,035	100
1 0133 901 014 *	4,5 x 6,5	15	40	0,040	100
1 0133 901 005 *	5,0 x 7,0	20	50	0,045	100
1 0133 901 006 *	6,5 x 8,9	25	65	0,065	50
1 0133 901 018 *	7,2 x 9,6	25	65	0,075	50
1 0133 901 007 *	7,7 x 10,1	30	75	0,180	50

\* Lieferzeit und Mindestbestellmenge auf Anfrage    Delivery time and minimum order quantity on request

🔥 -40°C ... +100°C ^ +130°C



# FLEXAspiral PA 12

Wickel- und Bündelungsspirale

Spiral binding

## MATERIAL

Polyamid [PA 12]

## MATERIAL

Polyamide [PA 12]

## EIGENSCHAFTEN

- Bündelung von Einzeldrähten
- Schutz von Kabelbäumen und Leitungen
- mechanischer Schutz von bewegten Leitungen

## PROPERTIES

- bundling of single wires
- protection of wire harnesses, wires and lines
- mechanical protection for loosely installed or moving cables and lines

## ANWENDUNGSGEBIETE

- Installationstechnik
- Schaltschrankbau
- Maschinen- und Anlagenbau
- Roboter
- Fahrzeugbau
- Automation

## APPLICATION

- machine and plant construction
- switch cabinet construction
- machine and plant constructions
- robotics
- automotive
- automation



### FLEXA No.



### Einsatzbereich Application



	mm	min mm	max mm	kg m	m
schwarz black					
1 0241 102 020	4,0 x 6,0	6,0	20,0	0,020	50
1 0241 102 040	6,0 x 8,0	8,0	40,0	0,030	50
1 0241 102 045	8,0 x 10,0	10,0	45,0	0,050	50
1 0241 102 050	9,0 x 12,0	12,0	50,0	0,070	50

# FLEXAspiral PE

Wickel- und Bündelungsspirale

Spiral binding

 -40°C ... +90°C ^ +100°C

## MATERIAL

LD-Polyethylen [PE]

## MATERIAL

LD-Polyethylene [PE]



## EIGENSCHAFTEN

- Bündelung von Einzeldrähten
- Schutz von Kabelbäumen und Leitungen
- mechanischer Schutz von bewegten Leitungen

## PROPERTIES

- bundling of single wires
- protection of wire harnesses, wires and lines
- mechanical protection for loosely installed or moving cables and lines

## ANWENDUNGSGEBIETE

- Installationstechnik
- Schaltschrankbau
- Maschinen- und Anlagenbau
- Roboter
- Fahrzeugbau
- Automation

## APPLICATION

- machine and plant construction
- switch cabinet construction
- machine and plant constructions
- robotics
- automotive
- automation



FLEXA No.

FLEXA No.



Einsatzbereich  
Application



schwarz  
black

transparent  
transparent

mm

min  
mm

max  
mm

kg/m

m

1 0241 602 020	1 0241 605 020	4,0 x 6,0	6,0	20,0	0,016	50
1 0241 602 040	1 0241 605 040	6,0 x 8,0	8,0	40,0	0,026	50
1 0241 602 045	1 0241 605 045	8,0 x 10,0	10,0	45,0	0,038	50
1 0241 602 050	1 0241 605 050	9,0 x 12,0	12,0	50,0	0,052	50

Verkaufspackung 10 m | 10 m sales pack

1 0241 602 120	1 0241 605 120	4,0 x 6,0	6,0	20,0	0,016	10
1 0241 602 140	1 0241 605 140	6,0 x 8,0	8,0	40,0	0,026	10
1 0241 602 145	1 0241 605 145	8,0 x 10,0	10,0	45,0	0,038	10
1 0241 602 150	1 0241 605 150	9,0 x 12,0	12,0	50,0	0,052	10



🔥 -50°C ... +350°C ^ +700°C



Passende Verschraubungen  
Suitable connectors

Seite | page

	US-M	08. 4
	US-P	08. 7
	NIMS-M P	08.32
	SGL	08.32



## FLEXA hightemp

Feuerschutzschlauch  
Calciumsilikat-Geflecht mit  
SI-Mantel

Fire protection conduit  
Calcium-silicate-braiding with  
SI sheathing

### MATERIAL

Schutzschlauch Calciumsilikat-Geflecht  
Mantel Silikon [SI]

### MATERIAL

Conduit calcium-silicate-braiding  
Sheathing silicone [SI]

### VERWENDUNG

- Überzug für Kabel und Leitungen  
Hydraulik-Schläuche und  
Kühlwasser-Schlauchleitungen
- für den Brandschutz – vor hohen  
Temperaturen und offenem Feuer,  
Funkenflug und Metallspritzer
- für den Unfallschutz – verhindert  
Verbrennungen an Armaturen,  
Auspuff oder heißen Metallschläuchen

### APPLICATION

- cover for cables and main leads  
hydraulic hoses and  
cooling-circuit-hoses
- for fire protection – protection  
against high temperatures, open flames  
and metal-splash
- for accident protection – no  
burning on fittings, exhausts  
or hot metal hoses

### EIGENSCHAFTEN

- wetterfest
- wasserdicht
- weitgehend seewasser-, säure- und  
ölbeständig
- gute Strahlenbeständigkeit
- abriebfest
- sehr flexibel
- nicht brennbar, auch kein Nachbrennen
- selbstverlöschend
- DIN 5510 [ST2/SR2/S4]

### PROPERTIES

- weatherproof
- watertight
- widely resistant to seawater,  
acids and oils
- good radiation resistance
- abrasive resistant
- very flexible
- non-flammable, even no afterglow
- self-extinguishing
- DIN 5510 [ST2/SR2/S4]

### ANWENDUNGSGEBIETE

- Stahlindustrie
- Gießereien
- Chemische Industrie
- Erdöl Raffinerien
- Schiffsbau
- Verkehrstechnik
- Bergbau
- Glasfabriken
- Schienenfahrzeuge

### APPLICATION

- steel industry
- foundries
- chemical companies
- oil companies
- shipbuilders
- public transportation
- mining industry
- glass factories
- railway industry

FLEXA No.

AD  
OD

NW



rot red

ø

mm

kg/m

m

1 2061 809 010	17	10	10,0 x 17,0	0,119	15
1 2061 809 015	21	15	15,0 x 22,0	0,209	15
1 2061 809 020	27	20	20,0 x 27,0	0,213	15
1 2061 809 022	-	22	22,0 x 29,0	0,239	15
1 2061 809 025	-	25	25,0 x 32,0	0,291	15
1 2061 809 030	36	30	30,0 x 37,0	0,342	15
1 2061 809 035	-	35	35,0 x 42,0	0,390	15
1 2061 809 040	45	40	40,0 x 47,0	0,380	15
1 2061 809 050	56	50	50,0 x 57,0	0,733	15
1 2061 809 060	-	60	60,0 x 67,0	0,750	15

# FLEXAhightemp

FLEXAhightemp Wickelband  
Band mit fester Webkante

FLEXAhightemp Tape  
Tape with tightly woven selvages

🌡️ -50°C ... +300°C ^ +700°



## MATERIAL

Fireblocker-Beschichtung  
Calciumsilikat

## MATERIAL

fireblocker coating  
calcium-silicate

## VERWENDUNG

zum nachträglichen Aufbringen von  
Feuerschutz

## APPLICATION

for additional fire protection  
installation

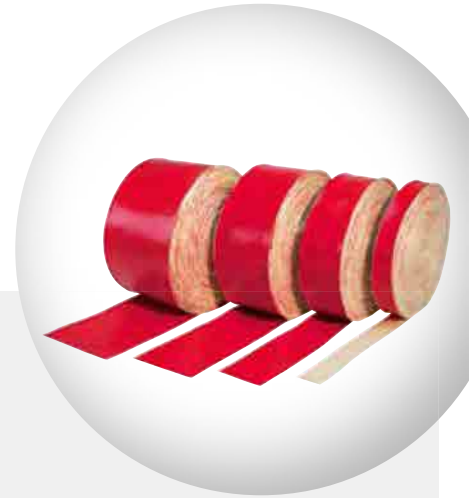

### FLEXA No.

Breite  
width

Stärke  
thickness



rot red

ø

kg|m

m

1 2061 899 025	25	2 - 3	0,040	10
1 2061 899 050	50	2 - 3	0,080	10
1 2061 899 075	75	2 - 3	0,120	10
1 2061 899 100	100	2 - 3	0,170	10



# FLEXAhightemp

FLEXAhightemp Klebeband  
für FLEXAhightemp  
Feuerschutzschläuche

FLEXAhightemp Wrapping Tape  
for FLEXAhightemp  
fire protection conduits

🌡️ -50°C ... +300°C



## MATERIAL

Silikon-Beschichtung

## MATERIAL

silicone coating

## VERWENDUNG

zum Fixieren von FLEXAhightemp  
Feuerschutzschläuchen und  
FLEXAhightemp Wickelband

## APPLICATION

for fastening of the FLEXAhightemp  
fire protection conduits and the  
FLEXAhightemp tape



### FLEXA No.

Breite  
width



rot red

ø

kg|m

m

1 2061 898 025	25		0,020	9
----------------	----	--	-------	---

# 08

## ANSCHLUSSTECHNIK CONNECTORS



ZUORDNUNGSTABELLE  
ASSIGNMENT TABLE

Nenngröße AD Schlauch-Außen-ø	Metr. Gewinde EN 60423	PG Gewinde DIN 40430
Trade Size OD Tubing outer ø	metric Thread EN 60423	PG Thread DIN 40430
10,0	M 10 x 1,0	PG 7
10,0	M 12 x 1,5	
14,0	M 12 x 1,5	PG 9
14,0	M 16 x 1,5	
17,0	M 16 x 1,5	PG 11
17,0	M 20 x 1,5	
19,0		PG 13,5
21,0	M 20 x 1,5	PG 16
21,0	M 25 x 1,5	
27,0	M 25 x 1,5	PG 21
27,0	M 32 x 1,5	
36,0	M 32 x 1,5	PG 29
36,0	M 40 x 1,5	
45,0	M 40 x 1,5	PG 36
45,0	M 50 x 1,5	
56,0	M 50 x 1,5	PG 48
56,0	M 63 x 1,5	

**US – M | – P**  
Metallverschraubung  
Metal connector

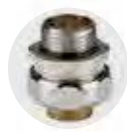

08. 2

**USB – M**  
Metallverschraubung  
Bogen 90°  
Metal connector  
bend 90°



08.20

**NIMS – M | – P**  
Metall Schlaucholive  
Metal conduit olive



08.32

**US2 – M**  
Metallverschraubung  
Metal connector



08. 8

**USW – M | – P**  
Metallverschraubung  
Winkel 90°  
Metal connector  
elbow 90°



08.22

**SGL**  
Schelle passend zu  
Typ NIMS  
Clamp suitable for  
type NIMS



08.32

**USDR – M**  
Metallverschraubung  
drehbares Gewinde  
Metal connector  
turnable thread



08.10

**USK – M | – P**  
Kunststoffverschraubung  
Plastic connector



08.26

**MSD**  
Druckring  
Material Messing  
Thrust collar  
Material brass



08.33

**USZ – M**  
Metallverschraubung  
Zugentlastung  
Metal connector  
strain relief



08.12

**LKI – M | – P**  
Kunststoffverschraubung  
einteilig mit Innentülle  
drehbar  
Plastic connector  
one-part with ferrule  
turnable



08.27

**TED**  
Dichtring  
Material PTFE  
Sealing  
Material PTFE



08.33

**USZ – EX – M**  
Metallverschraubung  
Zugentlastung  
Metal connector  
strain relief



08.14

**US – FOOD – M**  
Metallverschraubung  
lebensmittelecht  
Metal connector  
food-safe



08.28

**EK**  
Endtülle  
Material Polypropylen  
Terminal sleeve  
Material polypropylene



08.34

**USD – M | – P**  
Metallverschraubung  
Metal connector



08.16

**EG – M | – P**  
Metallverschraubung  
Metal connector



08.29

**AK**  
Endtülle | Übergangsstülle  
von Schlauch zu Kabel  
Material TPE  
End cap | transition  
from tubing to cable  
Material TPE



08.34

**LI – M | – P**  
Metallverschraubung  
integrierte Innentülle  
drehbar  
Metal connector  
integrated ferrule  
turnable



08.18

**EW 45 – M | – P**  
Metallverschraubung  
Winkel 45°  
Metal connector  
elbow 45°



08.30

**EEM | EE**  
Endtülle | Innentülle  
Material Messing  
Terminal sleeve | ferrule  
Material brass



08.35

**LIF – M | – P**  
Metallverschraubung  
integrierte Innentülle  
Metal connector  
integrated ferrule

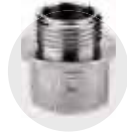

08.19

**EW 90 – M | – P**  
Metallverschraubung  
Winkel 90°  
Metal connector  
elbow 90°



08.31

**EE | EEK**  
Endtülle | Innentülle  
Material Kunststoff  
Terminal sleeve | ferrule  
Material plastics



08.36

**WERKZEUGE | TOOLS**

08.37

♦ IP 40 ... IP 66  
⌚ -40°C ... +125°C | +250°C [MSD]



## US-M

Metall-Sicherheitsverschraubung  
 gerade  
 Außengewinde  
 inkl. Innentülle, Dichtring oder  
 Messing-Druckring [MSD] und O-Ring

Metal connector, safety-type  
 straight  
 outer thread  
 incl. ferrule, sealing or  
 brass thrust collar [MSD] and O-ring

### KONSTRUKTION

Verschraubungsgehäuse mit Sechskant-  
 schlüsselfläche, Anschlussgewinde metrisch  
 nach EN 60423, Sechskantdruckmutter,  
 Kunststoff-Dichtring oder  
 Messing-Druckring, O-Ring  
 Innentülle aus Metall | Kunststoff

### STRUCTURE

Connector body with hexagonal wrench  
 surface, connecting thread metric  
 acc. to EN 60423, hexagon pressure nut,  
 plastic seal or brass thrust collar, O-ring  
 ferrule made of metal | plastics

### MATERIAL

Gehäuse	Messing vernickelt
Druckmutter	Messing vernickelt
Dichtring	TPE oder PTFE
Druckring	Messing
Innentülle	Messing   Kunststoff
O-Ring	NBR

### MATERIAL

Connector body	nickel-plated brass
Pressure nut	nickel-plated brass
Sealing ring	TPE or PTFE
Thrust collar	brass
Ferrule	brass   plastics
O-ring	NBR

### EIGENSCHAFTEN

- hoher Staub- und Flüssigkeitsschutz
- kraftschlüssige Verbindung von Schlauch und Verschraubung
- einwandfreie Erdung
- Abdeckung der Schlauchenden
- vibrations- und zugfest

### PROPERTIES

- highly watertight and dustproof
- friction-type locking of conduit and screw connector
- correct grounding
- covering of the conduit ends
- vibration- and tensionproof

### WICHTIG

Die Funktionssicherheit der Verschraubung  
 ist nur mit entsprechender Innentülle  
 gewährleistet.  
 Für EMV-Anwendung bitte die  
 Montageanleitung beachten.

### IMPORTANT

The security of the connector is only  
 guaranteed with the corresponding  
 ferrule.  
 For emc-usage please see our  
 assembly instructions.

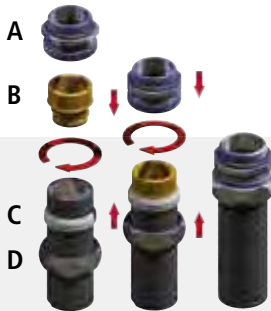
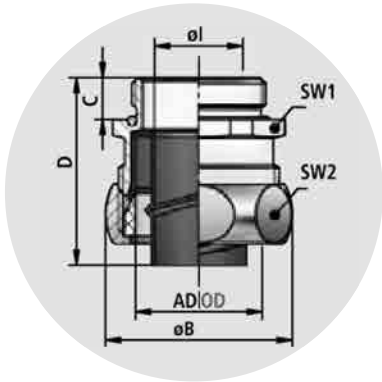

- A** Verschraubungsgehäuse  
 mit montiertem O-Ring  
 connector body with  
 mounted O-ring  
**B** Innentülle  
 ferrule  
**C** Dichtring oder  
 Messing-Druckring  
 sealing ring or  
 brass thrust collar  
**D** Druckmutter  
 pressure nut

AD  
OD



Technische Basisdaten US-M  
 Technical basic data US-M

$\phi$	Metr. EN 60423	$\phi B$ mm	C mm	D mm	SW1 mm	SW2 mm	kg 100
10	M 10 x 1,0	19,0	10,0	31,0	15	17	1,390
14	M 12 x 1,5	23,0	10,0	33,0	19	21	2,140
17	M 16 x 1,5	27,0	10,0	33,0	23	25	3,000
21	M 20 x 1,5	31,0	10,0	33,0	27	29	3,940
27	M 25 x 1,5	39,0	11,0	41,0	34	36	7,500
36	M 32 x 1,5	48,0	14,0	43,0	43	45	11,300
45	M 40 x 1,5	57,0	13,0	43,0	52	54	15,000
56	M 50 x 1,5	70,0	15,5	49,0	63	66	21,800
56	M 63 x 1,5	74,0	14,0	49,0	70	70	27,100



# US-M

🔥 IP 40 ... IP 65  
 🌡️ -40°C ... +125°C



VIDEO

AD  
OD



FLEXA No.



FLEXA No.



SPR-AS  
SPR-VA



Kleine VPE  
small packing units

ø	Metr. EN 60423	[IP 40]	mm	øl mm	St. pcs.	St. pcs.	
10	M 10 x 1,0	1 5010 327 010	8 x 10	6,5	50	1 5010 827 010	10
14	M 12 x 1,5	1 5010 327 012	11 x 14	9,0	50	1 5010 827 012	10
17	M 16 x 1,5	1 5010 327 016	14 x 17	12,5	50	1 5010 827 016	10
21	M 20 x 1,5	1 5010 327 020	18 x 21	16,0	50	1 5010 827 020	10
27	M 25 x 1,5	1 5010 327 025	23 x 27	21,0	25	1 5010 827 025	10
36	M 32 x 1,5	1 5010 327 032	31 x 36	27,5	25	1 5010 827 032	2
45	M 40 x 1,5	1 5010 327 040	40 x 45	35,0	20	1 5010 827 040	2
56	M 50 x 1,5	1 5010 327 050	51 x 56	45,0	10	1 5010 827 050	2
56	M 63 x 1,5	1 5010 327 163	51 x 56	49,0	10	1 5010 827 163	2



SPR-PA  
SPR-PU-F  
SPR-PVC-AS  
SPR-PU-AS



Kleine VPE  
small packing units

ø	Metr. EN 60423	[IP 65]	mm	øl mm	St. pcs.	St. pcs.	
10	M 10 x 1,0	1 5010 328 010	7 x 10	6,0	50	1 5010 828 010	10
14	M 12 x 1,5	1 5010 328 012	10 x 14	8,5	50	1 5010 828 012	10
17	M 16 x 1,5	1 5010 328 016	13 x 17	11,5	50	1 5010 828 016	10
21	M 20 x 1,5	1 5010 328 020	17 x 21	15,5	50	1 5010 828 020	10
27	M 25 x 1,5	1 5010 328 025	22 x 27	20,5	25	1 5010 828 025	10
36	M 32 x 1,5	1 5010 328 032	29 x 36	27,5	25	1 5010 828 032	2
45	M 40 x 1,5	1 5010 328 040	38 x 45	35,0	20	1 5010 828 040	2
56	M 50 x 1,5	1 5010 328 050	49 x 56	45,0	10	1 5010 828 050	2
56	M 63 x 1,5	1 5010 328 163	49 x 56	47,0	10	1 5010 828 163	2



FLEXAgraff®-PU-AS  
FLEXAgraff®-PU-F



Kleine VPE  
small packing units

ø	Metr. EN 60423	[IP 65]	mm	øl mm	St. pcs.	St. pcs.	
10	M 10 x 1,0	1 5010 328 010	7 x 10	6,0	50	1 5010 828 010	10
14	M 12 x 1,5	1 5010 327 012	11 x 14	9,0	50	1 5010 827 012	10
17	M 16 x 1,5	1 5010 328 016	13 x 17	11,5	50	1 5010 828 016	10
21	M 20 x 1,5	1 5010 328 020	17 x 21	15,5	50	1 5010 828 020	10
27	M 25 x 1,5	1 5010 340 025	23 x 27	21,0	25	1 5010 840 025	10
36	M 32 x 1,5	1 5010 328 032	29 x 36	27,5	25	1 5010 828 032	2
45	M 40 x 1,5	1 5010 328 040	38 x 45	35,0	20	1 5010 828 040	2
56	M 50 x 1,5	1 5010 328 050	49 x 56	45,0	10	1 5010 828 050	2
56	M 63 x 1,5	1 5010 328 163	49 x 56	47,0	10	1 5010 828 163	2



AIRflex®-KUW-PVC-AS  
AIRflex®-KUW-PU-AS  
AIRflex®-GRS [IP 65]  
AIRflex®-K



Kleine VPE  
small packing units



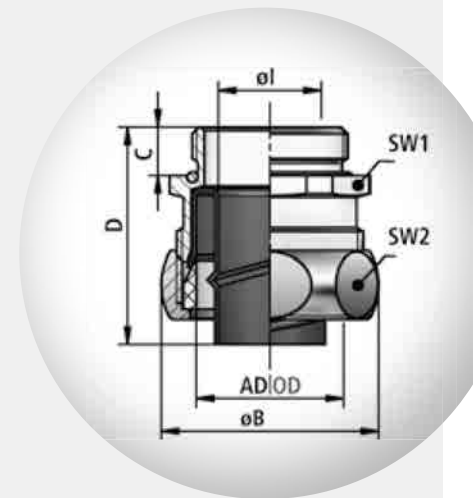



ø	Metr. EN 60423	[IP 54]	mm	øl mm	St. pcs.	St. pcs.	
10	M 10 x 1,0	1 5010 330 010	7 x 10	6,0	50	1 5010 830 010	10
14	M 12 x 1,5	1 5010 330 012	10 x 14	9,0	50	1 5010 830 012	10
17	M 16 x 1,5	1 5010 330 016	13 x 17	11,5	50	1 5010 830 016	10
21	M 20 x 1,5	1 5010 330 020	16 x 21	14,5	50	1 5010 830 020	10
27	M 25 x 1,5	1 5010 330 025	21 x 27	19,5	25	1 5010 830 025	10
36	M 32 x 1,5	1 5010 330 032	29 x 36	26,5	25	1 5010 830 032	2
45	M 40 x 1,5	1 5010 330 040	38 x 45	35,0	20	1 5010 830 040	2
56	M 50 x 1,5	1 5010 330 050	48 x 56	45,5	10	1 5010 830 050	2
56	M 63 x 1,5	1 5010 330 163	48 x 56	45,5	10	1 5010 830 163	2









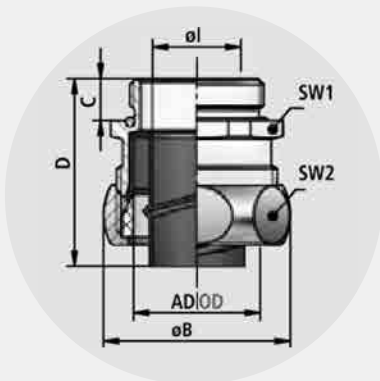

 IP 40 ... IP 66  
 -40°C ... +125°C | +250°C [MSD]

## US-M



AD OD		FLEXA No.				FLEXA No.	
		FLEXAgraff®-AS FLEXAgraff®-VA				Kleine VPE Small packing units	
ø	Metr. EN 60423	[IP 40]	mm	ø mm	St. pcs.	[IP 40]	St. pcs.
10	M 10 x 1,0	1 5010 327 010	8 x 10	6,5	50	1 5010 827 010	10
14	M 12 x 1,5	1 5010 339 012	12 x 14	9,0	50	1 5010 839 012	10
17	M 16 x 1,5	1 5010 327 016	14 x 17	12,5	50	1 5010 827 016	10
21	M 20 x 1,5	1 5010 327 020	18 x 21	16,5	50	1 5010 827 020	10
27	M 25 x 1,5	1 5010 339 025	24 x 27	21,0	25	1 5010 839 025	10
36	M 32 x 1,5	1 5010 327 032	31 x 36	27,5	25	1 5010 827 032	2
45	M 40 x 1,5	1 5010 327 040	40 x 45	35,0	20	1 5010 827 040	2
56	M 50 x 1,5	1 5010 327 050	51 x 56	45,0	10	1 5010 827 050	2
56	M 63 x 1,5	1 5010 327 163	51 x 56	49,0	10	1 5010 827 163	2



AD OD		FLEXA No.			FLEXA No.			
		FLEXAgraff®-SI-ASF						
ø	Metr. EN 60423	[IP 66]	mm	ø mm				St. pcs.
14	M 12 x 1,5	1 5010 337 012	10 x 14	9,0				50
17	M 16 x 1,5	1 5010 337 016	12 x 17	10,5				50
21	M 20 x 1,5	1 5010 335 020	16 x 21	14,5				50
27	M 25 x 1,5	1 5010 301 025	21 x 27	19,5				25
36	M 32 x 1,5	1 5010 337 032	27 x 36	25,5				25
45	M 40 x 1,5	1 5010 337 040	36 x 45	35,0				20
56	M 50 x 1,5	1 5010 337 050	47 x 56	45,0				10
56	M 63 x 1,5	1 5010 337 163	47 x 56	45,0				10

ø	Metr. EN 60423	[IP 40]	mm	ø mm	[IP 40]	mm	ø mm	St. pcs.
10	M 10 x 1,0	1 5011 328 010	7 x 10	6,0	1 5011 328 010	7 x 10	6,0	50
14	M 12 x 1,5	1 5011 327 012	11 x 14	9,0	1 5011 328 012	10 x 14	8,5	50
17	M 16 x 1,5	1 5011 328 016	13 x 17	11,5	1 5011 328 016	13 x 17	11,0	50
21	M 20 x 1,5	1 5011 328 020	17 x 21	16,0	1 5011 328 020	17 x 21	16,0	50
27	M 25 x 1,5	1 5011 340 025	23 x 27	21,0	1 5011 328 025	22 x 27	20,5	25
36	M 32 x 1,5	1 5011 328 032	29 x 36	27,5	1 5011 328 032	29 x 36	27,5	25
45	M 40 x 1,5	1 5011 328 040	38 x 45	35,0	1 5011 328 040	38 x 45	35,0	20
56	M 50 x 1,5	1 5011 328 050	49 x 56	45,0	1 5011 328 050	49 x 56	45,0	10
56	M 63 x 1,5	1 5011 328 163	49 x 56	47,0	1 5011 328 163	49 x 56	47,0	10

ø	Metr. EN 60423	[IP 54]	mm	ø mm	[IP 54]	mm	ø mm	St. Pcs.
14	M 12 x 1,5	1 5011 328 012	9 x 14	8,5	1 5011 328 012	9 x 14	8,5	50
17	M 16 x 1,5	1 5011 335 016	12 x 17	11,0	1 5011 335 016	12 x 17	11,0	50
21	M 20 x 1,5	1 5011 335 020	15 x 21	14,5	1 5011 335 020	16 x 21	14,5	50
27	M 25 x 1,5	1 5011 335 025	20 x 27	19,5	1 5011 301 025	21 x 27	19,5	25
36	M 32 x 1,5	1 5011 328 032	28 x 36	27,5	1 5011 337 032	28 x 36	25,5	25
45	M 40 x 1,5	1 5011 335 040	37 x 45	35,0	1 5011 335 040	37 x 45	35,0	20
56	M 50 x 1,5	1 5011 335 050	48 x 56	45,0	1 5011 335 050	48 x 56	45,0	10
56	M 63 x 1,5	1 5011 335 163	48 x 56	47,0	1 5011 335 163	48 x 56	47,0	10



VIDEO

# US-P

Metall-Sicherheitsverschraubung gerade, Außengewinde inkl. Innentülle, Dichtring oder Messing-Druckring [MSD] und O-Ring

Metal connector, safety-type straight, outer thread incl. ferrule, sealing or brass trust collar [MSD] and O-ring

🔥 IP 40 ... IP 66  
 🌡️ -40°C ... +125°C | +250°C [MSD]



VIDEO

## KONSTRUKTION

Verschraubungsgehäuse mit Sechskant-schlüsselfläche, Anschlussgewinde PG nach DIN 40430, Sechskantdruckmutter, Kunststoff-Dichtring oder Messing-Druckring, O-Ring Innentülle aus Metall / Kunststoff

## STRUCTURE

Connector body with hexagonal wrench surface, connecting thread PG acc. to DIN 40430, hexagon pressure nut, plastic seal or brass thrust collar, O-ring ferrule made of metal / plastics

## MATERIAL

Gehäuse Messing vernickelt  
 Druckmutter Messing vernickelt  
 Dichtring TPE oder PTFE  
 Druckring Messing  
 Innentülle Messing | Kunststoff  
 O-Ring NBR

## MATERIAL

Connector body nickel-plated brass  
 Pressure nut nickel-plated brass  
 Sealing ring TPE or PTFE  
 Thrust collar brass  
 Ferrule brass | plastics  
 O-ring NBR



## EIGENSCHAFTEN

- hoher Staub- und Flüssigkeitsschutz
- kraftschlüssige Verbindung von Schlauch und Verschraubung
- einwandfreie Erdung
- Abdeckung der Schlauchenden
- vibrations- und zugfest

## PROPERTIES

- highly watertight and dustproof
- friction-type locking of conduit and screw connector
- correct grounding
- covering of the conduit ends
- vibration- and tensionproof

## WICHTIG

Die Funktionssicherheit der Verschraubung ist nur mit entsprechender Innentülle gewährleistet. Für EMV-Anwendung bitte die Montageanleitung beachten.

## IMPORTANT

The security of the connector is only guaranteed with the corresponding ferrule. For emc-usage please see our assembly instructions.

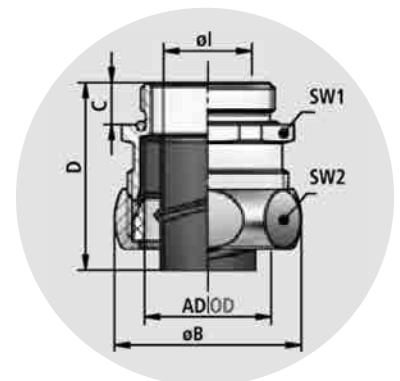

AD  
OD



Technische Basisdaten US-P  
 Technical basic data US-P

ø	PG DIN 40430	øB mm	C mm	D mm	SW1 mm	SW2 mm	kg 100
10	7	19,0	7,0	28,0	15	17	1,420
14	9	23,0	7,0	30,0	19	21	2,140
17	11	27,0	7,0	30,0	23	25	3,000
19	13,5	29,0	7,0	30,0	25	27	3,370
21	16	31,0	7,0	30,0	27	29	3,700
27	21	39,0	10,0	40,0	34	36	7,350
36	29	48,0	10,0	40,0	43	45	10,300
45	36	57,0	10,0	40,0	52	54	13,400
56	48	70,0	10,0	49,0	63	66	19,130

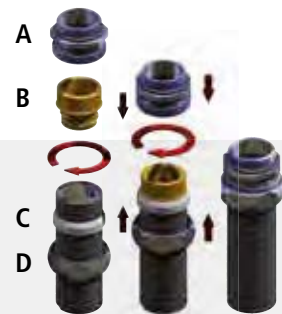







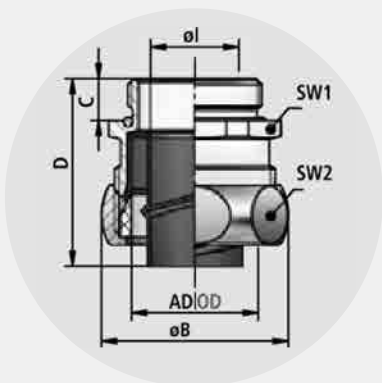





- A Verschraubungsgehäuse mit montiertem O-Ring  
connector body with mounted O-ring
- B Innentülle  
ferrule
- C Dichtring oder Messing-Druckring  
sealing ring or brass thrust collar
- D Druckmutter  
pressure nut

 IP 40 ... IP 65  
 -40°C ... +125°C

## US-P



VIDEO







AD OD		FLEXA No.				FLEXA No.	
		SPR-AS SPR-VA				Kleine VPE small packing units	
ø	PG DIN 40430	[IP 40]	mm	øl mm	St. pcs.		St. pcs.
10	7	1 5010 127 007	8 x 10	6,5	50	1 5010 427 007	10
14	9	1 5010 127 009	11 x 14	10,0	50	1 5010 427 009	10
17	11	1 5010 127 011	14 x 17	12,5	50	1 5010 427 011	10
19	13,5	1 5010 127 013	16 x 19	14,5	50	1 5010 427 013	10
21	16	1 5010 127 016	18 x 21	16,5	50	1 5010 427 016	10
27	21	1 5010 127 021	23 x 27	21,5	25	1 5010 427 021	10
36	29	1 5010 127 029	31 x 36	29,0	25	1 5010 427 029	2
45	36	1 5010 127 036	40 x 45	38,0	20	1 5010 427 036	2
56	48	1 5010 127 048	51 x 56	49,0	10	1 5010 427 048	2
		SPR-PA SPR-PU-F SPR-PVC-AS SPR-PU-AS				Kleine VPE small packing units	
ø	PG DIN 40430	[IP 65]	mm	øl mm	St. pcs.		St. pcs.
10	7	1 5010 128 007	7 x 10	6,0	50	1 5010 428 007	10
14	9	1 5010 128 009	10 x 14	8,5	50	1 5010 428 009	10
17	11	1 5010 128 011	13 x 17	11,5	50	1 5010 428 011	10
19	13,5	1 5010 128 013	15 x 19	13,5	50	1 5010 428 013	10
21	16	1 5010 128 016	17 x 21	15,5	50	1 5010 428 016	10
27	21	1 5010 128 021	22 x 27	20,5	25	1 5010 428 021	10
36	29	1 5010 128 029	29 x 36	27,5	25	1 5010 428 029	2
45	36	1 5010 128 036	38 x 45	36,5	20	1 5010 428 036	2
56	48	1 5010 128 048	49 x 56	47,5	10	1 5010 428 048	2
		FLEXAgraff®-PU-AS FLEXAgraff®-PU-F				Kleine VPE small packing units	
ø	PG DIN 40430	[IP 65]	mm	øl mm	St. pcs.		St. pcs.
10	7	1 5010 128 007	7 x 10	6,0	50	1 5010 428 007	10
14	9	1 5010 127 009	11 x 14	10,0	50	1 5010 427 009	10
17	11	1 5010 128 011	13 x 17	11,5	50	1 5010 428 011	10
19	13,5	1 5010 128 013	15 x 19	13,5	50	1 5010 428 013	10
21	16	1 5010 128 016	17 x 21	15,5	50	1 5010 428 016	10
27	21	1 5010 140 021	23 x 27	21,5	25	1 5010 440 021	10
36	29	1 5010 128 029	29 x 36	27,5	25	1 5010 428 029	2
45	36	1 5010 128 036	38 x 45	36,5	20	1 5010 428 036	2
56	48	1 5010 128 048	49 x 56	47,5	10	1 5010 428 048	2
		AIRflex®-KUW-PVC-AS AIRflex®-KUW-PU-AS AIRflex®-GRS [IP 65] AIRflex®-K				Kleine VPE small packing units	
ø	PG DIN 40430	[IP 54]	mm	øl mm	St. pcs.		St. pcs.
10	7	1 5010 130 007	7 x 10	6,0	50	1 5010 430 007	10
14	9	1 5010 130 009	10 x 14	9,0	50	1 5010 430 009	10
17	11	1 5010 130 011	13 x 17	11,5	50	1 5010 430 011	10
19	13,5	1 5010 130 013	15 x 19	13,0	50	1 5010 430 013	10
21	16	1 5010 130 016	16 x 21	14,5	50	1 5010 430 016	10
27	21	1 5010 130 021	21 x 27	19,5	25	1 5010 430 021	10
36	29	1 5010 130 029	29 x 36	26,5	25	1 5010 430 029	2
45	36	1 5010 130 036	38 x 45	36,0	20	1 5010 430 036	2
56	48	1 5010 130 048	48 x 56	46,5	10	1 5010 430 048	2







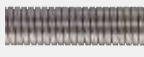

# US-P

IP 40 ... IP 66  
 -40°C ... +125°C | +250°C [MSD]



VIDEO

AD OD		FLEXA No.				FLEXA No.	
		FLEXAgraft®-AS FLEXAgraft®-VA				Kleine VPE small packing units	
ø	PG DIN 40420	[IP 40]	mm	øl mm	St. pcs.	[IP 40]	St. pcs.
10	7	1 5010 127 007	8 x 10	6,5	50	1 5010 427 007	10
14	9	1 5010 139 009	12 x 14	10,5	50	1 5010 439 009	10
17	11	1 5010 127 011	14 x 17	12,5	50	1 5010 427 011	10
19	13,5	1 5010 127 013	16 x 19	14,5	50	1 5010 427 013	10
21	16	1 5010 127 016	18 x 21	16,5	50	1 5010 427 016	10
27	21	1 5010 139 021	24 x 27	22,5	25	1 5010 439 021	10
36	29	1 5010 127 029	31 x 36	29,5	25	1 5010 427 029	2
45	36	1 5010 127 036	40 x 45	38,0	20	1 5010 427 036	2
56	48	1 5010 127 048	51 x 56	49,0	10	1 5010 427 048	2

AD OD		FLEXA No.			FLEXA No.			
		FLEXAgraft®-SI-ASF						
ø	PG DIN 40420	[IP 66]	mm	øl mm	St. pcs.			
14	9	1 5010 137 009	10 x 14	9,0	50			
17	11	1 5010 137 011	12 x 17	10,5	50			
21	16	1 5010 135 016	16 x 21	14,5	50			
27	21	1 5010 601 021	21 x 27	19,5	25			
36	29	1 5010 137 029	27 x 36	26,5	25			
45	36	1 5010 137 036	36 x 45	34,5	20			
56	48	1 5010 137 048	47 x 56	45,5	10			

ø	PG DIN 40420	[IP 40]	mm	øl mm	[IP 40]	mm	øl mm	St. pcs.
10	7	1 5011 128 007	7 x 10	6,0	1 5011 128 007	7 x 10	6,0	50
14	9	1 5011 127 009	11 x 14	10,0	1 5011 128 009	10 x 14	8,5	50
17	11	1 5011 128 011	13 x 17	11,5	1 5011 128 011	13 x 17	11,5	50
19	13,5	1 5011 128 013	15 x 19	13,5	1 5011 128 013	15 x 19	13,5	50
21	16	1 5011 128 016	17 x 21	15,5	1 5011 128 016	17 x 21	15,5	50
27	21	1 5011 140 021	23 x 27	21,5	1 5011 128 021	22 x 27	20,5	25
36	29	1 5011 128 029	29 x 36	27,5	1 5011 128 029	29 x 36	27,5	25
45	36	1 5011 128 036	38 x 45	36,5	1 5011 128 036	38 x 45	36,5	20
56	48	1 5011 128 048	49 x 56	47,5	1 5011 128 048	49 x 56	47,5	10

ø	PG DIN 40420	[IP 54]	mm	øl mm	[IP 54]	mm	øl mm	St. pcs.
14	9	1 5011 128 009	9 x 14	8,5	1 5011 128 009	9 x 14	8,5	50
17	11	1 5011 135 011	12 x 17	11,0	1 5011 135 011	12 x 17	11,0	50
19	13,5	1 5011 135 013	14 x 19	13,0	1 5011 135 013	14 x 19	13,0	50
21	16	1 5011 135 016	15 x 21	14,5	1 5011 135 016	16 x 21	14,5	50
27	21	1 5011 135 021	20 x 27	19,5	1 5011 601 021	21 x 27	19,5	25
36	29	1 5011 128 029	28 x 36	27,5	1 5011 137 029	28 x 36	27,5	25
45	36	1 5011 135 036	37 x 45	35,5	1 5011 135 036	37 x 45	35,5	20
56	48	1 5011 135 048	48 x 56	47,0	1 5011 135 048	48 x 56	47,0	10



IP 40 ... IP 65  
 -40°C ... +125°C | +250°C [MSD]



## US2-M

Metall-Sicherheitsverschraubung  
 gerade  
 Innengewinde  
 inkl. Innentülle und Dichtring aus TPE  
 oder Messing-Druckring [MSD]

Metal connector, safety-type  
 straight  
 inner thread  
 incl. ferrule and sealing made of TPE  
 or brass thrust collar [MSD]

### KONSTRUKTION

Verschraubungsgehäuse mit Sechskant-  
 schlüsselfläche, Anschlussgewinde  
 metrisch nach EN 60423, Sechskantdruck-  
 mutter, Kunststoff-Dichtring oder  
 Messing-Druckring, Innentülle aus Metall

### STRUCTURE

Connector body with hexagonal wrench  
 surface, connecting thread metric acc. to  
 EN 60423, hexagon pressure nut,  
 plastic seal or brass thrust collar,  
 ferrule made of metal

### MATERIAL

Gehäuse Messing vernickelt  
 Druckmutter Messing vernickelt  
 Dichtring TPE oder PTFE  
 Druckring Messing  
 Innentülle Messing

### MATERIAL

Connector body nickel-plated brass  
 Pressure nut nickel-plated brass  
 Sealing ring TPE or PTFE  
 Thrust collar brass  
 Ferrule brass

### EIGENSCHAFTEN

- hoher Staub- und Flüssigkeitsschutz
- kraftschlüssige Verbindung von Schlauch und Verschraubung
- einwandfreie Erdung
- Abdeckung der Schlauchenden
- vibrations- und zugfest

### PROPERTIES

- highly watertight and dustproof
- friction-type locking of conduit and screw connector
- correct grounding
- covering of the conduit ends
- vibration- and tensionproof

### WICHTIG

Die Funktionssicherheit der Verschraubung ist nur mit entsprechender Innentülle gewährleistet.  
 Für EMV-Anwendung bitte die Montageanleitung beachten.

### IMPORTANT

The security of the connector is only guaranteed with the corresponding ferrule.  
 For emc-usage please see our assembly instructions.

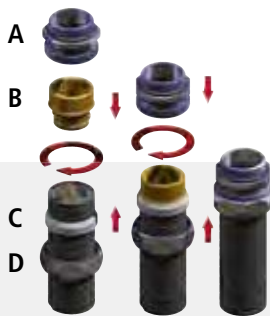
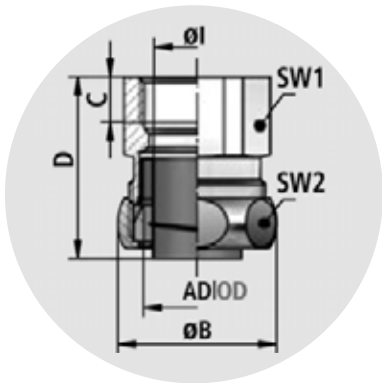

- A Verschraubungsgehäuse mit montiertem O-Ring  
 connector body with mounted O-ring
- B Innentülle  
 ferrule
- C Dichtring oder Messing-Druckring  
 sealing ring or brass thrust collar
- D Druckmutter  
 pressure nut

AD  
 OD



Technische Basisdaten US2-M  
 Technical basic data US2-M

ø	Metr. EN 60423	øB mm	C mm	D mm	SW1 mm	SW2 mm	kg 100
10	M 10 x 1,5	19,0	8,0	26,0	15	17	1,500
14	M 12 x 1,5	23,0	8,0	27,0	21	21	2,300
17	M 16 x 1,5	27,0	8,0	27,0	24	25	3,000
21	M 20 x 1,5	31,0	10,0	30,0	30	29	4,000
27	M 25 x 1,5	39,0	11,0	37,0	36	36	7,600
36	M 32 x 1,5	48,0	11,0	39,0	46	45	10,100
45	M 40 x 1,5	57,0	12,0	42,0	55	54	13,500
56	M 50 x 1,5	70,0	12,0	46,0	65	66	20,000

# US2-M

🔥 IP 40 ... IP 65  
 🌡️ -40°C ... +125°C | +250°C [MSD]



VIDEO



SPR-AS  
SPR-VA



SPR-PA  
SPR-PU-F  
SPR-PVC-AS  
SPR-PU-AS



FLEXAgraff®-AS  
FLEXAgraff®-VA



FLEXAgraff®-PU-AS  
FLEXAgraff®-PU-F



AIRflex®-KUW-EDU

SPR-CU-AS  
SPR-EDU-AS

ø	Metr. EN 60423	[IP 40]			[IP 65]			St. pcs.
		mm	mm	ø1 mm	mm	mm	ø1 mm	
10	M 10 x 1,5	1 5012 327 010	7 x 10	7,5	1 5012 328 010	7 x 10	6,0	25
14	M 12 x 1,5	1 5012 327 012	11 x 14	7,5	1 5012 328 012	10 x 14	8,5	25
17	M 16 x 1,5	1 5012 327 016	14 x 17	11,0	1 5012 328 016	13 x 17	11,5	25
21	M 20 x 1,5	1 5012 327 020	18 x 21	14,5	1 5012 328 020	17 x 21	15,5	25
27	M 25 x 1,5	1 5012 327 025	23 x 27	19,5	1 5012 328 025	22 x 27	20,5	10
36	M 32 x 1,5	1 5012 327 032	31 x 36	27,5	1 5012 328 032	29 x 36	27,5	10
45	M 40 x 1,5	1 5012 327 040	40 x 45	35,5	1 5012 328 040	38 x 45	35,0	5
56	M 50 x 1,5	1 5012 327 050	51 x 56	47,0	1 5012 328 050	49 x 56	45,0	5

ø	Metr. EN 60423	[IP 40]			[IP 65]			St. pcs.
		mm	mm	ø1 mm	mm	mm	ø1 mm	
10	M 10 x 1,5	1 5012 327 010	8 x 10	6,5	1 5012 328 010	7 x 10	6,0	25
14	M 12 x 1,5	1 5012 339 012	12 x 14	9,0	1 5012 327 012	11 x 14	9,0	25
17	M 16 x 1,5	1 5012 327 016	14 x 17	12,5	1 5012 328 016	13 x 17	11,5	25
21	M 20 x 1,5	1 5012 327 020	18 x 21	16,5	1 5012 328 020	17 x 21	15,5	25
27	M 25 x 1,5	1 5012 339 025	24 x 27	21,0	1 5012 340 025	23 x 27	20,5	10
36	M 32 x 1,5	1 5012 327 032	31 x 36	27,5	1 5012 328 032	29 x 36	27,5	10
45	M 40 x 1,5	1 5012 327 040	40 x 45	35,0	1 5012 328 040	38 x 45	35,0	5
56	M 50 x 1,5	1 5012 327 050	51 x 56	45,0	1 5012 328 050	49 x 56	45,0	5

ø	Metr. EN 60423	[IP 54]			[IP 40]			St. pcs.
		mm	mm	ø1 mm	mm	mm	ø1 mm	
10	M 10 x 1,5				1 5018 328 010	7 x 10	6,0	10
14	M 12 x 1,5	1 5018 328 012	9 x 14	7,5	1 5018 328 012	10 x 14	8,5	10
17	M 16 x 1,5	1 5018 335 016	12 x 17	11,0	1 5018 328 016	13 x 17	11,5	10
21	M 20 x 1,5	1 5018 335 020	15 x 21	14,5	1 5018 328 020	17 x 21	15,5	10
27	M 25 x 1,5	1 5018 335 025	20 x 27	19,5	1 5018 328 025	22 x 27	20,5	10
36	M 32 x 1,5	1 5018 328 032	28 x 36	27,5	1 5018 328 032	29 x 36	27,5	10
45	M 40 x 1,5	1 5018 335 040	37 x 45	35,5	1 5018 328 040	38 x 45	35,0	5
56	M 50 x 1,5	1 5018 335 050	48 x 56	47,0	1 5018 328 050	49 x 56	45,0	5

ø	Metr. EN 60423	[IP 40]			St. pcs.
		mm	mm	ø1 mm	
10	M 10 x 1,5	1 5018 328 010	7 x 10	6,0	10
14	M 12 x 1,5	1 5018 327 012	11 x 14	9,0	10
17	M 16 x 1,5	1 5018 328 016	13 x 17	11,5	10
21	M 20 x 1,5	1 5018 328 020	17 x 21	15,5	10
27	M 25 x 1,5	1 5018 340 025	23 x 27	20,5	10
36	M 32 x 1,5	1 5018 328 032	29 x 36	27,5	10
45	M 40 x 1,5	1 5018 328 040	38 x 45	35,0	5
56	M 50 x 1,5	1 5018 328 050	49 x 56	45,0	5

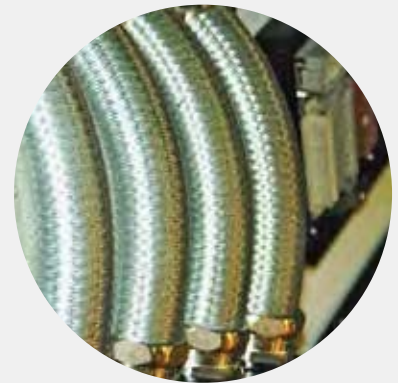

IP 40 ... IP 65  
 -40°C ... +125°C | +250°C [MSD]



## USD-R-M

Metall-Sicherheitsverschraubung  
 gerade  
 Außengewinde drehbar  
 inkl. Innentülle, Dichtring aus TPE  
 oder Messing-Druckring [MSD] und O-Ring

Metal connector, safety-type  
 straight  
 turnable outer thread  
 incl. ferrule, sealing made of TPE  
 or brass thrust collar [MSD] and O-ring

### KONSTRUKTION

Verschraubungsgehäuse mit Sechskant-  
 schlüsselfläche, Anschlussgewinde  
 metrisch nach EN 60423, Sechskantdruck-  
 mutter, Kunststoff-Dichtring oder Messing-  
 Druckring, O-Ring, Innentülle aus Metall

### STRUCTURE

Connector body with hexagonal wrench  
 surface, connecting thread metric acc. to  
 EN 60423, hexagon pressure nut,  
 plastic seal or brass thrust collar, O-ring,  
 ferrule made of metal

### MATERIAL

Gehäuse Messing vernickelt  
 Druckmutter Messing vernickelt  
 Dichtring TPE oder PTFE  
 Druckring Messing  
 Innentülle Messing  
 O-Ring NBR

### MATERIAL

Connector body nickel-plated brass  
 Pressure nut nickel-plated brass  
 Sealing ring TPE or PTFE  
 Thrust collar brass  
 Ferrule brass  
 O-ring NBR

### EIGENSCHAFTEN

- hoher Staub- und Flüssigkeitsschutz
- kraftschlüssige Verbindung von Schlauch und Verschraubung
- einwandfreie Erdung
- Abdeckung der Schlauchenden
- vibrations- und zugfest

### PROPERTIES

- highly watertight and dustproof
- friction-type locking of conduit and screw connector
- correct grounding
- covering of the conduit ends
- vibration- and tensionproof

### WICHTIG

Die Funktionssicherheit der Verschraubung ist nur mit entsprechender Innentülle gewährleistet.  
 Für EMV-Anwendung bitte die Montageanleitung beachten.

### IMPORTANT

The security of the connector is only guaranteed with the corresponding ferrule.  
 For emc-usage please see our assembly instructions.

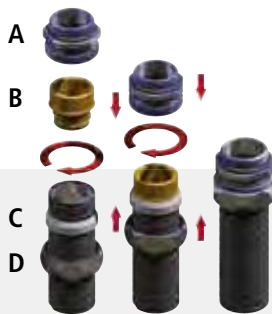
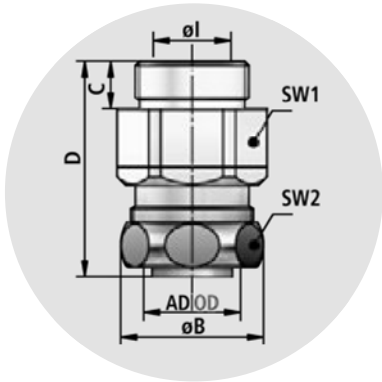

- A** Verschraubungsgehäuse mit montiertem O-Ring  
 connector body with mounted O-ring
- B** Innentülle  
 ferrule
- C** Dichtring oder Messing-Druckring  
 sealing ring or brass thrust collar
- D** Druckmutter  
 pressure nut

AD  
 OD









Technische Basisdaten USD-R-M  
 Technical basic data USD-R-M

ø	Metr. EN 60423	øB mm	C mm	D mm	SW1 mm	SW2 mm	kg 100
10	M 12 x 1,5	19,0	10,0	28,0	15	17	2,400
14	M 16 x 1,5	23,0	10,0	30,0	21	21	5,000
17	M 20 x 1,5	27,0	10,0	30,0	24	25	6,400
21	M 25 x 1,5	31,0	11,0	31,0	30	29	9,500
27	M 32 x 1,5	39,0	13,0	38,0	36	36	14,900
36	M 40 x 1,5	48,0	13,0	42,0	46	45	23,900
45	M 50 x 1,5	57,0	14,0	50,0	55	54	36,200
56	M 63 x 1,5	70,0	14,0	54,0	70	66	61,000



# USDR-M

IP 40 ... IP 65  
-40°C ... +125°C | +250°C [MSD]

AD OD  FLEXA No.   FLEXA No.   

 SPR-AS  
SPR-VA



FLEXA No. SPR-PA  
SPR-PU-F  
SPR-PVC-AS  
SPR-PU-AS





VIDEO

ø	Metr. EN 60423	[IP 40]		[IP 65]		St. pcs.		
		mm	øl mm	mm	øl mm			
10	M 12 x 1,5	1 5013 327 012	8 x 10	6,5	1 5013 328 012	7 x 10	6,0	10
14	M 16 x 1,5	1 5013 327 016	11 x 14	7,5	1 5013 328 016	10 x 14	8,5	10
17	M 20 x 1,5	1 5013 327 020	14 x 17	11,0	1 5013 328 020	13 x 17	11,5	10
21	M 25 x 1,5	1 5013 327 025	18 x 21	14,5	1 5013 328 025	17 x 21	15,5	10
27	M 32 x 1,5	1 5013 327 032	23 x 27	19,5	1 5013 328 032	22 x 27	20,5	10
36	M 40 x 1,5	1 5013 327 040	31 x 36	27,5	1 5013 328 040	29 x 36	27,5	2
45	M 50 x 1,5	1 5013 327 050	40 x 45	35,5	1 5013 328 050	38 x 45	35,0	2
56	M 63 x 1,5	1 5013 327 063	51 x 56	47,0	1 5013 328 063	49 x 56	45,0	2

 FLEXAgraff®-AS  
FLEXAgraff®-VA



FLEXAgraff®-PU-AS  
FLEXAgraff®-PU-F



ø	Metr. EN 60423	[IP 40]		[IP 65]		St. pcs.		
		mm	øl mm	mm	øl mm			
10	M 12 x 1,5	1 5013 327 012	8 x 10	6,5	1 5013 328 012	7 x 10	6,0	10
14	M 16 x 1,5	1 5013 339 016	12 x 14	9,0	1 5013 327 016	11 x 14	9,0	10
17	M 20 x 1,5	1 5013 327 020	14 x 17	12,5	1 5013 328 020	13 x 17	11,5	10
21	M 25 x 1,5	1 5013 327 025	18 x 21	16,5	1 5013 328 025	17 x 21	15,5	10
27	M 32 x 1,5	1 5013 339 032	24 x 27	21,0	1 5013 340 032	23 x 27	20,5	10
36	M 40 x 1,5	1 5013 327 040	31 x 36	27,5	1 5013 328 040	29 x 36	27,5	2
45	M 50 x 1,5	1 5013 327 050	40 x 45	35,0	1 5013 328 050	38 x 45	35,0	2
56	M 63 x 1,5	1 5013 327 063	51 x 56	45,0	1 5013 328 063	49 x 56	45,0	2

 AIRflex®-KUW-EDU



SPR-CU-AS  
SPR-EDU-AS



ø	Metr. EN 60423	[IP 54]		[IP 40]		St. pcs.		
		mm	øl mm	mm	øl mm			
10	M 12 x 1,5			1 5014 328 012	7 x 10	6,0	10	
14	M 16 x 1,5	1 5014 328 016	9 x 14	8,5	1 5014 328 016	10 x 14	8,5	10
17	M 20 x 1,5	1 5014 335 020	12 x 17	11,0	1 5014 328 020	13 x 17	11,5	10
21	M 25 x 1,5	1 5014 335 025	15 x 21	14,5	1 5014 328 025	17 x 21	15,5	10
27	M 32 x 1,5	1 5014 335 032	20 x 27	19,5	1 5014 328 032	22 x 27	20,5	10
36	M 40 x 1,5	1 5014 328 040	28 x 36	27,5	1 5014 328 040	29 x 36	27,5	2
45	M 50 x 1,5	1 5014 335 050	37 x 45	35,0	1 5014 328 050	38 x 45	35,0	2
56	M 63 x 1,5	1 5014 335 063	48 x 56	45,0	1 5014 328 063	51 x 56	45,0	2

 FLEXAgraff®-CU-AS



ø	Metr. EN 60423	[IP 40]		St. pcs.	
		mm	øl mm		
10	M 12 x 1,5	1 5014 328 012	7 x 10	6,0	10
14	M 16 x 1,5	1 5014 327 016	11 x 14	9,0	10
17	M 20 x 1,5	1 5014 328 020	13 x 17	11,5	10
21	M 25 x 1,5	1 5014 328 025	17 x 21	15,5	10
27	M 32 x 1,5	1 5014 340 032	23 x 27	20,5	10
36	M 40 x 1,5	1 5014 328 040	29 x 36	27,5	2
45	M 50 x 1,5	1 5014 328 050	38 x 45	35,0	2
56	M 63 x 1,5	1 5014 328 063	49 x 56	45,0	2



IP 40 ... IP 65  
-40°C ... +100°C



## USZ-M

Metall-Sicherheitsverschraubung  
gerade  
Außengewinde  
Zugentlastung  
inkl. Innentülle, Dichtring aus TPE oder  
Messing-Druckring [MSD] und O-Ring

Metal connector, safety-type  
straight  
outer thread  
strain relief  
incl. ferrule, sealing made of TPE  
or brass thrust collar [MSD] and O-ring

### KONSTRUKTION

Verschraubungsgehäuse mit Sechskant-  
schlüssel­fläche, Anschlussgewinde  
metrisch nach EN 60423, Sechskant-  
Druckmutter, Kunststoff-Dichtring  
oder Messing-Druckring, O-Ring,  
Innentülle aus Metall

### STRUCTURE

Connector body with hexagonal wrench  
surface, connecting thread metric acc. to  
EN 60423, hexagon pressure nut,  
plastic seal or brass thrust collar, O-ring,  
ferrule made of metal

### MATERIAL

Gehäuse Messing vernickelt  
Druckmutter Messing vernickelt  
Dichtring TPE oder PTFE  
Druckring Messing  
Zwischenstück Messing vernickelt  
Dichteinsatz TPE  
Innentülle Messing  
O-Ring NBR

### MATERIAL

Connector body nickel-plated brass  
Pressure nut nickel-plated brass  
Sealing ring TPE or PTFE  
Thrust collar brass  
Intermediate part nickel-plated brass  
Sealing insert TPE  
Ferrule brass  
O-ring NBR

### EIGENSCHAFTEN

- hoher Staub- und Flüssigkeitsschutz
- kraftschlüssige Verbindung von  
Schlauch und Verschraubung
- einwandfreie Erdung
- Abdeckung der Schlauchenden
- vibrations- und zugfest

### PROPERTIES

- highly watertight and dustproof
- friction-type locking of conduit  
and screw connector
- correct grounding
- covering of the conduit ends
- vibration- and tensionproof

### WICHTIG

Die Funktionssicherheit der Verschraubung  
ist nur mit entsprechender Innentülle  
gewährleistet.  
Für EMV-Anwendung bitte die  
Montageanleitung beachten.

### IMPORTANT

The security of the connector is only  
guaranteed with the corresponding  
ferrule.  
For emc-usage please see our  
assembly instructions.

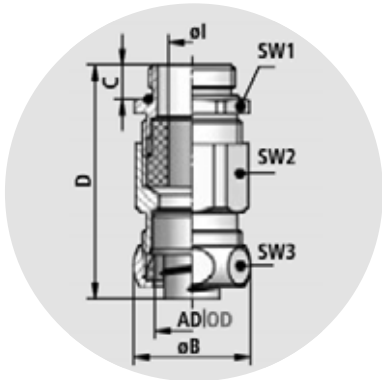

- A Verschraubungsgehäuse  
mit montiertem O-Ring  
connector body with  
mounted O-ring
- B Innentülle  
ferrule
- C Dichtring oder  
Messing-Druckring  
sealing ring or  
brass thrust collar
- D Druckmutter  
pressure nut

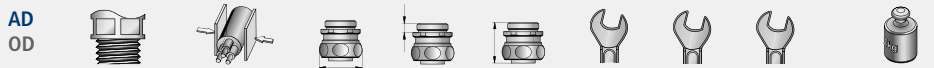

Technische Basisdaten USZ-M  
Technical basic data USZ-M

ø	Metr. EN 60423	mm	øB mm	C mm	D mm	SW1 mm	SW2 mm	SW3 mm	kg/100
10	M 12 x 1,5	5,0 - 6,5	19,0	10,0	43,0	15	16	17	2,090
14	M 16 x 1,5	6,0 - 10,5	23,0	10,0	48,0	18	21	21	4,070
17	M 20 x 1,5	8,0 - 14,5	27,0	10,0	48,0	24	24	25	5,390
21	M 20 x 1,5	8,0 - 14,5	31,0	10,0	49,0	24	29	29	6,990
21	M 25 x 1,5	12,5 - 19,0	31,0	11,0	54,0	30	30	29	7,210
27	M 25 x 1,5	12,5 - 19,0	39,0	11,0	61,0	30	36	36	13,200
27	M 32 x 1,5	17,0 - 25,5	39,0	13,0	65,0	36	36	36	14,650
36	M 40 x 1,5	24,0 - 33,0	48,0	13,0	68,0	46	46	45	23,870
45	M 50 x 1,5	33,0 - 42,0	57,0	14,0	74,0	55	55	54	31,150
56	M 63 x 1,5	40,0 - 52,0	70,0	14,0	81,0	70	70	66	34,000

# USZ-M

🔥 IP 40 ... IP 65  
 🌡️ -40°C ... +100°C

AD  
OD



FLEXA No.



FLEXA No.



VIDEO



SPR-AS  
SPR-VA



SPR-PA  
SPR-PU-F  
SPR-PVC-AS  
SPR-PU-AS



ø	Metr. EN 60423	[IP 40]		[IP 65]		St. pcs.		
		mm	øl mm	mm	øl mm			
10	M 12 x 1,5	1 5016 327 112	8 x 10	6,5	1 5016 328 112	7 x 10	6,0	10
14	M 16 x 1,5	1 5016 327 116	11 x 14	9,0	1 5016 328 116	10 x 14	8,5	10
17	M 20 x 1,5	1 5016 327 120	14 x 17	12,5	1 5016 328 120	13 x 17	11,5	10
21	M 20 x 1,5	1 5016 327 020	18 x 21	16,0	1 5016 328 020	17 x 21	15,5	10
21	M 25 x 1,5	1 5016 327 125	18 x 21	16,0	1 5016 328 125	17 x 21	15,5	10
27	M 25 x 1,5	1 5016 327 025	23 x 27	21,0	1 5016 328 025	22 x 27	20,5	10
27	M 32 x 1,5	1 5016 327 132	23 x 27	21,0	1 5016 328 132	22 x 27	20,5	10
36	M 40 x 1,5	1 5016 327 140	31 x 36	27,5	1 5016 328 140	29 x 36	27,5	5
45	M 50 x 1,5	1 5016 327 150	40 x 45	35,0	1 5016 328 150	38 x 45	35,0	5
56	M 63 x 1,5	1 5016 327 163	51 x 56	45,0	1 5016 328 163	49 x 56	45,0	5



FLEXAgraff®-AS  
FLEXAgraff®-VA



FLEXAgraff®-PU-AS  
FLEXAgraff®-PU-F



ø	Metr. EN 60423	[IP 40]		[IP 65]		St. pcs.		
		mm	øl mm	mm	øl mm			
10	M 12 x 1,5	1 5016 327 112	8 x 10	6,5	1 5016 328 112	7 x 10	6,0	10
14	M 16 x 1,5	1 5016 339 116	12 x 14	9,0	1 5016 327 116	11 x 14	9,0	10
17	M 20 x 1,5	1 5016 327 120	14 x 17	12,5	1 5016 328 120	13 x 17	11,5	10
21	M 20 x 1,5	1 5016 327 020	18 x 21	16,0	1 5016 328 020	17 x 21	15,5	10
21	M 25 x 1,5	1 5016 327 125	18 x 21	16,0	1 5016 328 125	17 x 21	15,5	10
27	M 25 x 1,5	1 5016 339 025	24 x 27	21,0	1 5016 340 025	23 x 27	20,5	10
27	M 32 x 1,5	1 5016 339 132	24 x 27	21,0	1 5016 340 132	23 x 27	20,5	10
36	M 40 x 1,5	1 5016 327 140	31 x 36	27,5	1 5016 328 140	29 x 36	27,5	5
45	M 50 x 1,5	1 5016 327 150	40 x 45	35,0	1 5016 328 150	38 x 45	35,0	5
56	M 63 x 1,5	1 5016 327 163	51 x 56	45,0	1 5016 328 163	49 x 56	45,0	5



AIRflex®-KUW-EDU



SPR-CU-AS  
SPR-EDU-AS



ø	Metr. EN 60423	[IP 54]		[IP 40]		St. pcs.		
		mm	øl mm	mm	øl mm			
10	M 12 x 1,5			1 5017 328 112	7 x 10	6,0	10	
14	M 16 x 1,5	1 5017 328 116	9 x 14	9,0	1 5017 328 116	10 x 14	8,5	10
17	M 20 x 1,5	1 5017 335 120	12 x 17	12,5	1 5017 328 120	13 x 17	11,5	10
21	M 20 x 1,5	1 5017 335 020	15 x 21	16,0	1 5017 328 020	17 x 21	15,5	10
21	M 25 x 1,5	1 5017 335 125	15 x 21	16,0	1 5017 328 125	17 x 21	15,5	10
27	M 25 x 1,5	1 5017 335 025	20 x 27	21,0	1 5017 328 025	22 x 27	20,5	10
27	M 32 x 1,5	1 5017 335 032	20 x 27	21,0	1 5017 328 132	22 x 27	20,5	10
36	M 40 x 1,5	1 5017 328 140	28 x 36	27,5	1 5017 328 140	29 x 36	27,5	5
45	M 50 x 1,5	1 5017 335 150	37 x 45	35,0	1 5017 328 150	38 x 45	35,0	5
56	M 63 x 1,5	1 5017 335 163	48 x 56	45,0	1 5017 328 163	49 x 56	45,0	5



FLEXAgraff®-CU-AS



ø	Metr. EN 60423	[IP 40]		St. pcs.	
		mm	øl mm		
10	M 12 x 1,5	1 5017 328 112	7 x 10	6,0	10
14	M 16 x 1,5	1 5017 327 116	11 x 14	9,0	10
17	M 20 x 1,5	1 5017 328 120	13 x 17	11,0	10
21	M 20 x 1,5	1 5017 328 020	17 x 21	15,5	10
21	M 25 x 1,5	1 5017 328 125	17 x 21	15,5	10
27	M 25 x 1,5	1 5017 340 025	23 x 27	20,5	10
27	M 32 x 1,5	1 5017 340 132	23 x 27	20,5	10
36	M 40 x 1,5	1 5017 328 140	29 x 36	27,5	5
45	M 50 x 1,5	1 5017 328 150	38 x 45	35,0	5
56	M 63 x 1,5	1 5017 328 163	49 x 56	45,0	5



IP 40  
-40°C ... +100°C

# USZ-EX-M

Metall-Sicherheitsverschraubung gerade, Außengewinde, Zugentlastung für Einsatz im EX-Bereich inkl. Innentülle, Dichtring aus TPE oder Messing-Druckring [MSD] und O-Ring

Metal connector, safety-type straight, outer thread, strain relief for application in EX-Area incl. ferrule, sealing made of TPE or brass thrust collar [MSD] and O-ring

## KONSTRUKTION

Verschraubungsgehäuse mit Sechskantschlüsselfläche, Anschlussgewinde metrisch nach EN 60423, Sechskantdruckmutter, Kunststoff-Dichtring oder Messing-Druckring, O-Ring, Innentülle aus Metall

## STRUCTURE

Connector body with hexagonal wrench surface, connecting thread metric acc. to EN 60423, hexagon pressure nut, plastic seal or brass thrust collar, O-ring, ferrule made of metal

## MATERIAL

Gehäuse	Messing vernickelt
Druckmutter	Messing vernickelt
Klemmring	TPE
Druckring	Messing
Innentülle	Messing
Zwischenstück	Messing vernickelt
Dichteinsatz	TPE
Zwischenstutzen	Messing vernickelt
O-Ring	NBR

## MATERIAL

Connector body	nickel-plated brass
Pressure nut	nickel-plated brass
Clamp collar	TPE
Thrust collar	brass
Ferrule	brass
Intermediate part	nickel-plated brass
Sealing insert	TPE
Lower part	nickel-plated brass
O-ring	NBR

Kennzeichnung der Verschraubung  
 Ex II 2 G Ex e II  
 Ex II 2 D Ex tD A21 IP 66 | IP68

Marking of the cable gland  
 Ex II 2 G Ex e II  
 Ex II 2 D Ex tD A21 IP 66 | IP68

## EIGENSCHAFTEN

- hoher Staub- und Flüssigkeitsschutz
- kraftschlüssige Verbindung von Schlauch und Verschraubung
- einwandfreie Erdung
- Abdeckung der Schlauchenden
- vibrations- und zugfest
- erhöhte Sicherheit „e“ nach EN 60079-0:2014, EN 60079-7:2016, EN 61241-0:2006 und EN 61241-1:2004

## PROPERTIES

- highly watertight and dustproof
- friction-type locking of conduit and screw connector
- correct grounding
- covering of the conduit ends
- vibration- and tensionproof
- increased safety "e" acc. to EN 60079-0:2014, EN 60079-7:2016, EN 61241-0:2006 and EN 61241-1:2004

## WICHTIG

Es dürfen nur metallische oder metallisch umflochtene Schutzschläuche ohne äußeren Kunststoffmantel verwendet werden.

## IMPORTANT

Only metallic or metal-braided protection conduits without exterior plastic sheathing must be used.

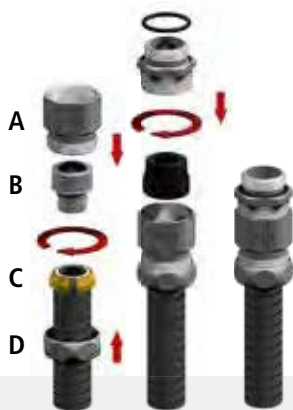
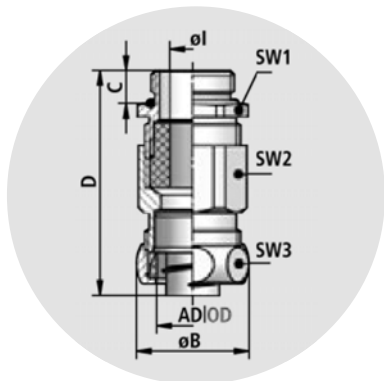

- A Verschraubungsgehäuse mit montiertem O-Ring  
connector body with mounted O-ring
- B Innentülle  
ferrule
- C Dichtring oder Messing-Druckring  
sealing ring or brass thrust collar
- D Druckmutter  
pressure nut

AD  
OD

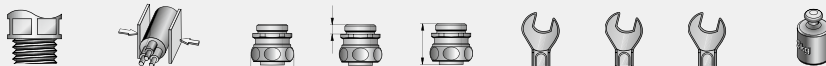

Technische Basisdaten USZ-EX-M  
 Technical basic data USZ-EX-M

ø	Metr. EN 60423	mm	øB mm	C mm	D mm	SW1 mm	SW2 mm	SW3 mm	kg 100
17	M 20 x 1,5	9,5 - 11,0	27,0	10,0	48,0	24	24	25	6,600
21	M 20 x 1,5	12,0 - 15,0	31,0	10,0	49,0	24	29	29	9,700
21	M 25 x 1,5	13,0 - 16,0	31,0	11,0	54,0	30	30	29	9,900
27	M 32 x 1,5	19,0 - 21,0	39,0	13,0	65,0	36	36	36	16,600

# USZ-EX-M

IP 40  
-40°C ... +100°C



VIDEO



SPR-AS  
SPR-VA



FLEXAgraff®-AS  
FLEXAgraff®-VA

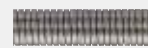

ø	Metr. EN 60423	[IP 40]	mm		øl mm	[IP 40]		mm	øl mm	St. pcs.
17	M 20 x 1,5	1 5023 327 120	14 x 17	12,5	12,5	1 5023 327 120	14 x 17	12,5	10	
21	M 20 x 1,5	1 5023 327 020	18 x 21	16,0	16,0	1 5023 327 020	18 x 21	16,0	10	
21	M 25 x 1,5	1 5023 327 125	18 x 21	16,0	16,0	1 5023 327 125	18 x 21	16,0	10	
27	M 32 x 1,5	1 5023 327 132	23 x 27	21,0	21,0	1 5023 339 132	24 x 27	21,0	10	



SPR-CU-AS  
SPR-EDU-AS



ø	Metr. EN 60423	[IP 40]	mm		øl mm	St. pcs.
17	M 20 x 1,5	1 5024 328 120	13 x 17	11,5	11,5	10
21	M 20 x 1,5	1 5024 328 020	17 x 21	15,5	15,5	10
21	M 25 x 1,5	1 5024 328 125	17 x 21	15,5	15,5	10
27	M 32 x 1,5	1 5024 328 132	22 x 27	20,5	20,5	10



IP 67  
-40°C ... +125°C



## USD

EMV Metallverschraubung  
gerade  
Außengewinde  
inkl. Innentülle und O-Ring

EMC metal connector  
straight  
outer thread  
incl. ferrule and O-Ring

### KONSTRUKTION

Gehäuse mit Sechskantschlüsselfläche,  
feststehendes Anschlussgewinde,  
verlängerte Sechskantdruckmutter,  
Dichtring, Messing-Druckring,  
Innentülle und O-Ring

### STRUCTURE

Connector body with hexagonal wrench  
surface, longer hexagonal pressure nut,  
sealing ring, brass thrust collar  
ferrule and O-ring

### MATERIAL

Gehäuse Messing vernickelt  
Druckmutter Messing vernickelt  
Dichtring TPE  
Druckring Messing  
Innentülle Messing  
O-Ring NBR

### MATERIAL

Connector body nickel-plated brass  
Pressure nut nickel-plated brass  
Sealing ring TPE  
Thrust collar brass  
Ferrule brass  
O-ring NBR

### EIGENSCHAFTEN

- hoher Staub- | Flüssigkeitsschutz
- einwandfreie Erdung
- Abdeckung der Schlauchenden
- vibrations- und zugfest
- flüssigkeitsdichte EMV-Schutzverschraubung durch verlängerte Druckmutter

### PROPERTIES

- highly watertight and dust proof
- correct grounding
- covering of the conduit ends
- vibrationproof and tensionproof
- liquid tight emc connector due to longer pressure nut

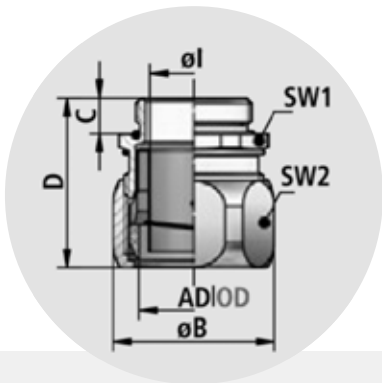

- A Verschraubungsgehäuse mit montiertem O-Ring  
connector body with mounted O-ring
- B MS-Innentülle  
brass ferrule
- C EMV-Messingdruckring  
emc brass thrust collar
- D TPE-Dichtring  
TPE sealing ring
- E Druckmutter  
pressure nut

AD  
OD



Technische Basisdaten USD-M  
Technical basic data USD-M

ø	Metr. EN 60423	øB mm	C mm	D mm	SW1 mm	SW2 mm	kg 100
14	M 12 x 1,5	23,0	10,0	33,0	19	21	2,800
17	M 16 x 1,5	27,0	10,0	33,0	23	25	3,800
21	M 20 x 1,5	31,0	10,0	33,0	27	29	5,000
27	M 25 x 1,5	39,0	11,0	42,0	34	36	9,100
36	M 32 x 1,5	48,0	13,0	47,0	43	45	10,800
45	M 40 x 1,5	57,0	13,0	47,0	52	54	18,600
56	M 50 x 1,5	70,0	14,0	52,0	63	66	23,400

Technische Basisdaten USD-P  
Technical basic data USD-P

ø	PG DIN 40430	øB mm	C mm	D mm	SW1 mm	SW2 mm	kg 100
14	9	23,0	7,0	30,0	19	21	2,800
17	11	27,0	7,0	30,0	23	25	3,700
19	13,5	29,0	7,0	30,0	25	27	4,980
21	16	31,0	7,0	30,0	27	29	4,800
27	21	39,0	10,0	41,0	34	36	9,000
36	29	48,0	10,0	44,0	43	45	9,700
45	36	57,0	10,0	44,0	52	54	20,000
56	48	70,0	10,0	48,0	63	66	21,000

## USD

## MONTAGEANLEITUNG

1. Schutzschauch FLEXAgraff-CU-PU mit geeigneter Schneidvorrichtung trennen.
2. Verschraubung demontieren und Druckmutter über das Schutzschlauchende schieben.
3. TPE Dichtring mit abgeschrägter Seite in Richtung Druckmutter über den Schutzschlauch schieben.
4. Den Kunststoffmantel vorsichtig in der 1,5-fachen Breite des Messing-Druckrings abmanteln.
5. Überstehende CU-Flechtäden mit einer Schere sauber und plan zum Schlauch entfernen.
6. EMV-Messingdruckring seitenrichtig mit gerader Seite gemäß Bildfolge auf den Schutzschlauch schieben.
7. Innentülle bis zum Anschlag in Schutzschlauch eindrehen (Hilfswerkzeug auf Anfrage).
8. Verschraubungsgehäuse mit aufmontierten Teilen zusammenfügen und zur guten Kontaktierung mit Hilfe von Werkzeug (Maulschlüssel) fest verschrauben (10 Nm).

## ASSEMBLY INSTRUCTION

1. Cut the FLEXAgraff-CU-PU conduit (emc-safe) with appropriate cutting tool.
2. Dismount connector and push pressure screw over protection hose.
3. Push the TPE sealing over the conduit with the inclined side facing the pressure screw.
4. Strip the plastic jacket off the conduit with care for the 1.5 fold width of the brass-thrust collar.
5. Cut any remaining CU braiding. Make sure it is a clean cut which leaves the braiding at the exact length of the conduit.
6. Push the EMC brass thrust collar (cone formed end in the right direction) over the protective tube as shown in picture.
7. Screw ferrule into the protection hose until its end (auxiliary tool on demand).
8. Combine the connector body with the mounted parts and tighten the connection with a hexagon wrench for optimal contact (10 Nm).

🔥 IP 67  
 🌡️ -40°C ... +125°C



VIDEO

AD  
OD

FLEXA No.



## USD-M

FLEXAgraff®-CU-PU

ø	Metr. EN 60423	[IP 67]	mm	øl mm	St. pcs.
14	M 12 x 1,5	1 5015 327 012	11,0 x 15,0	9,0	10
17	M 16 x 1,5	1 5015 328 016	13,0 x 18,0	11,5	10
21	M 20 x 1,5	1 5015 328 020	17,0 x 21,0	15,5	10
27	M 25 x 1,5	1 5015 340 025	23,0 x 28,0	20,5	10
36	M 32 x 1,5	1 5015 328 032	29,0 x 37,0	27,5	2
45	M 40 x 1,5	1 5015 328 040	38,0 x 46,0	35,0	2
56	M 50 x 1,5	1 5015 328 050	49,0 x 57,0	45,0	2

## USD-P

FLEXAgraff®-CU-PU

ø	PG DIN 40430	[IP 67]	mm	øl mm	St. pcs.
14	9	1 5015 127 009	11,0 x 15,0	10,0	10
17	11	1 5015 128 011	13,0 x 18,0	11,5	10
21	16	1 5015 128 016	17,0 x 22,0	15,5	10
27	21	1 5015 140 021	23,0 x 28,0	21,5	10
36	29	1 5015 128 029	29,0 x 37,0	27,5	2
45	36	1 5015 128 036	38,0 x 46,0	36,5	2
56	48	1 5015 128 048	49,0 x 57,0	48,0	2

IP 40  
-40°C ... +250°C



VIDEO



## LI

Metallverschraubung  
gerade, Außengewinde  
integrierte Innentülle, drehbar

Metal connector  
straight, outer thread  
integrated ferrule, turnable

### KONSTRUKTION

Rundes Verschraubungsgehäuse  
drehbar, Sechskantschlüsselfläche,  
Außengewinde metrisch nach  
EN 60423 oder PG nach DIN 40430  
einschnappbare Schlauchgewindetülle

### STRUCTURE

Round connector body  
turnable, hexagonal wrench surface  
outer thread metric acc. to EN 60423  
or PG acc. to DIN 40430  
snap in threaded ferrule

### MATERIAL

Gehäuse Messing vernickelt  
Innentülle Messing blank  
Sicherungsring Federstahl

### MATERIAL

Connector body nickel-plated brass  
Ferrule polished brass  
Locking ring spring steel

### EIGENSCHAFTEN

- integrierte Schlauchdreh Sperre
- Abdeckung der Schlauchenden
- vibrations- und zugfest

### PROPERTIES

- integrated conduit screw out
- covering of the conduit ends
- vibrationproof and tensionproof

### MONTAGE

Innentülle auf das Schlauchende drehen  
und danach in das Verschraubungs-  
gehäuse einstecken.

### ASSEMBLY

Screw the ferrule into the end of the  
conduit and push the connector body  
into the ferrule.

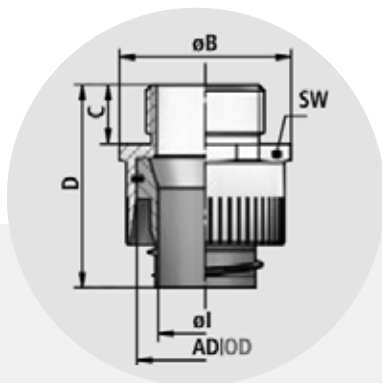

### LI-M

Kleine VPE  
small packing unit

ø	Metr. EN 60423	[IP 40]	øl mm	øB mm	C mm	D mm	SW mm	kg 100	St. pcs.	St. pcs.
10	M 10 x 1,0	1 5010 012 010	6,0	17,0	10,0	32,0	15	1,660	50	1 5010 712 010 10
14	M 12 x 1,5	1 5010 012 012	9,0	21,0	10,0	33,0	19	2,240	50	1 5010 712 012 10
17	M 16 x 1,5	1 5010 012 016	12,0	25,0	10,0	33,0	23	3,200	50	1 5010 712 016 10
21	M 20 x 1,5	1 5010 012 020	15,5	29,0	10,0	35,0	27	4,260	50	1 5010 712 020 10
27	M 25 x 1,5	1 5010 012 025	20,5	37,0	11,0	36,0	34	7,000	25	1 5010 712 025 10
36	M 32 x 1,5	1 5010 012 032	27,5	46,0	13,0	43,0	43	12,080	25	1 5010 712 032 2
45	M 40 x 1,5	1 5010 012 040	35,0	62,0	13,0	43,0	54	13,500	25	1 5010 712 040 2
56	M 50 x 1,5	1 5010 012 050	45,0	76,0	14,0	44,0	66	25,600	10	1 5010 712 050 2

### LI-P

Kleine VPE  
small packing unit

ø	PG DIN 40430	[IP 40]	øl mm	øB mm	C mm	D mm	SW mm	kg 100	St. pcs.	St. pcs.
10	7	1 5010 010 007	6,0	16,0	7,0	29,0	15	1,580	50	1 5010 710 007 10
14	9	1 5010 010 009	9,0	21,0	7,0	30,0	19	2,240	50	1 5010 710 009 10
17	11	1 5010 010 011	12,0	24,5	7,0	30,0	23	2,920	50	1 5010 710 011 10
19	13,5	1 5010 010 013	13,5	27,0	7,0	30,0	25	3,560	50	1 5010 710 013 10
21	16	1 5010 010 016	15,5	29,0	7,0	32,0	27	4,040	50	1 5010 710 016 10
27	21	1 5010 010 021	20,5	37,0	10,0	35,0	34	6,760	25	1 5010 710 021 10
36	29	1 5010 010 029	27,5	46,0	10,0	40,0	43	11,000	25	1 5010 710 029 2
45	36	1 5010 010 036	36,5	58,0	10,0	40,0	55	13,500	25	1 5010 710 036 2
56	48	1 5010 010 048	47,0	68,0	10,0	40,0	66	19,500	10	1 5010 710 048 2



A Verschraubungsgehäuse  
connector body

B Innentülle  
ferrule



## LIF

Metallverschraubung  
gerade  
Außengewinde

Metal connector  
straight  
outer thread

IP 40  
-40°C ... +250°C

## KONSTRUKTION

Rundes Verschraubungsgehäuse  
mit Sechskantschlüsselfläche,  
feststehendes Außengewinde metrisch  
nach EN 60423 oder PG nach DIN 40430

## STRUCTURE

Round connector body  
hexagonal wrench surface  
fixed outer thread metric acc. to  
EN 60423 or PG acc. to DIN 40430

## MATERIAL

Gehäuse Messing vernickelt  
Abdeckhülse Messing vernickelt

## MATERIAL

Connector body nickel-plated brass  
Cover sleeve nickel-plated brass

## EIGENSCHAFTEN

- integrierte Schlauchdrehsperr
- Abdeckung der Schlauchenden
- vibrations- und zugfest

## PROPERTIES

- integrated conduit screw out
- covering of the conduit ends
- vibrationproof and tensionproof

## MONTAGE

Abdeckhülse auf das Schlauchende  
stecken und danach das Verschraubungs-  
gehäuse eindrehen

## ASSEMBLY

Push the cover sleeve on the end of the  
conduit and screw the connector body in  
the conduit



AD  
OD



FLEXA No.



FLEXA No.



## LIF-M

Kleine VPE  
small packing unit

ø	Metr. EN 60423	[IP 40]	øI mm	øB mm	C mm	D mm	SW mm	kg 100 St. pcs.	St. pcs.	FLEXA No.	St. pcs.
10	M 12 x 1,5	1 5801 310 012	5,9	16,0	10,0	26,0	15	1,550	50	1 5801 810 012	10
14	M 16 x 1,5	1 5801 314 016	8,9	21,0	10,0	27,0	19	2,400	50	1 5801 814 016	10
17	M 16 x 1,5	1 5801 317 016	11,0	25,0	10,0	27,0	23	3,000	50	1 5801 817 016	10
17	M 20 x 1,5	1 5801 317 020	12,0	25,0	10,0	27,0	23	2,900	50	1 5801 817 020	10
21	M 20 x 1,5	1 5801 321 020	15,0	29,0	10,0	27,0	27	3,800	50	1 5801 821 020	10
27	M 25 x 1,5	1 5801 327 025	20,0	37,0	11,0	30,5	34	6,300	25	1 5801 827 025	10
36	M 32 x 1,5	1 5801 336 032	27,5	45,6	13,0	33,0	43	8,100	25	1 5801 836 032	2
45	M 40 x 1,5	1 5801 345 040	35,0	59,0	13,0	33,0	54	13,300	25	1 5801 845 040	2
56	M 50 x 1,5	1 5801 356 050	45,0	69,0	14,0	34,0	66	18,500	10	1 5801 856 050	2

## LIF-P

Kleine VPE  
small packing unit

ø	PG DIN 40430	[IP 40]	øI mm	øB mm	C mm	D mm	SW mm	kg 100 St. pcs.	St. pcs.	FLEXA No.	St. pcs.
10	7	1 5801 010 007	5,9	16,0	10,0	26,0	15	1,600	50	1 5801 410 007	10
14	9	1 5801 014 009	8,9	21,0	10,0	27,0	19	2,400	50	1 5801 414 009	10
17	11	1 5801 017 011	12,0	25,0	10,0	27,0	23	3,100	50	1 5801 417 011	10
19	13,5	1 5801 019 013	14,0	27,0	10,0	27,0	25	3,200	50	1 5801 419 013	10
21	16	1 5801 021 016	15,9	29,0	10,0	27,0	27	3,900	50	1 5801 421 016	10
27	21	1 5801 027 021	20,4	37,0	11,0	30,6	34	6,200	25	1 5801 427 021	10
36	29	1 5801 036 029	27,5	45,6	13,0	33,0	43	8,800	25	1 5801 436 029	2
45	36	1 5801 045 036	36,6	59,0	13,0	33,0	54	11,750	25	1 5801 445 036	2
56	48	1 5801 056 048	47,5	69,0	13,5	33,5	66	16,400	10	1 5801 456 048	2

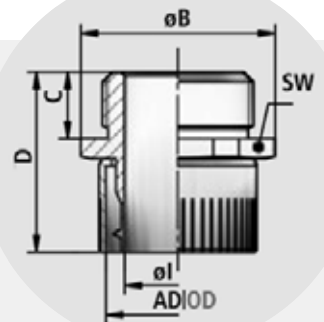

A Verschraubungsgehäuse  
connector body  
B Abdeckhülse  
cover sleeve

IP 40 ... IP 65  
-40°C ... +100°C

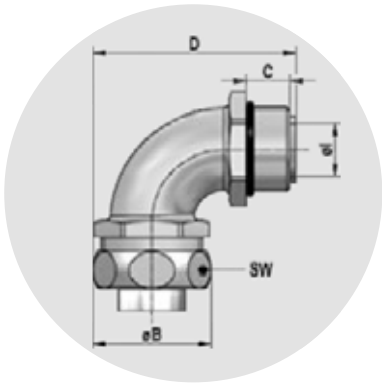

## USB-M

Metall-Sicherheitsverschraubung  
90° Bogen  
Außengewinde  
inkl. Innentülle, Dichtring und O-Ring

Metal connector, safety-type  
bend 90°  
outer thread  
incl. ferrule, sealing and O-ring

### KONSTRUKTION

Verschraubungsgehäuse mit Sechskant-schlüsselfläche, Anschlussgewinde metrisch nach EN 60423, Sechskantdruckmutter, Kunststoff-Dichtring zur Aufnahme der Innentülle aus Metall

### STRUCTURE

Connector body with hexagonal wrench surface, connecting thread metric acc. to EN 60423, hexagon pressure nut, plastic seal, to receive FLEXA ferrule made of metal

### MATERIAL

Gehäuse Messing vernickelt  
Druckmutter Messing vernickelt  
Dichtring TPE oder PTFE  
Innentülle Messing  
O-Ring NBR

### MATERIAL

Connector body nickel-plated brass  
Pressure nut nickel-plated brass  
Sealing ring TPE or PTFE  
Ferrule brass  
O-ring NBR

### EIGENSCHAFTEN

- hoher Staub- | Flüssigkeitsschutz
- kraftschlüssige Verbindung von Schlauch und Verschraubung
- einwandfreie Erdung
- Abdeckung der Schlauchenden
- vibrations- und zugfest

### PROPERTIES

- highly watertight and dustproof
- friction-type locking of conduit and screw connector
- correct grounding
- covering of the conduit ends
- vibration- and tensionproof

### WICHTIG

Die Funktionssicherheit der Verschraubung ist nur mit entsprechender Innentülle gewährleistet. Für EMV-Verwendung bitte die Montageanleitung beachten.

### IMPORTANT

The security of the connector is only guaranteed with the corresponding ferrule. For emc-usage please see our assembly instructions.



- A** Verschraubungsgehäuse mit montiertem O-Ring  
connector body with mounted O-ring
- B** Innentülle  
ferrule
- C** Dichtring oder Messing-Druckring  
sealing ring or brass thrust collar
- D** Druckmutter  
pressure nut

AD  
OD



Technische Basisdaten USB-M  
Technical basic data USB-M

ø	Metr. EN 60423	øB mm	C mm	D mm	SW mm	kg 100
17	M 16 x 1,5	27,0	11,5	47,2	25	16,400
21	M 20 x 1,5	31,5	13,0	53,9	29	28,000
27	M 25 x 1,5	39,0	15,0	64,2	36	43,200
36	M 32 x 1,5	48,0	15,0	73,7	45	66,000
45	M 40 x 1,5	57,0	16,0	86,5	54	110,000
56	M 50 x 1,5	70,0	18,0	101,7	66	160,000









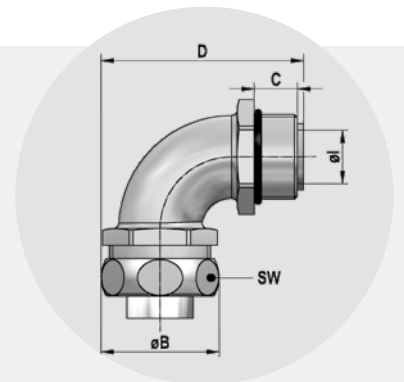





# USB-M

 IP 40 ... IP 65  
 -40°C ... +100°C



VIDEO



AD	OD	FLEXA No.			FLEXA No.			
		SPR-AS SPR-VA			SPR-PA SPR-PU-F SPR-PVC-AS SPR-PU-AS			
ø	Metr.	[IP 40]	mm	øI	[IP 65]	mm	øI	St.
	EN 60423			mm			mm	pcs.
17	M 16 x 1,5	1 5025 327 016	14 x 17	10,4	1 5025 328 016	13 x 17	10,4	25
21	M 20 x 1,5	1 5025 327 020	18 x 21	14,0	1 5025 328 020	17 x 21	14,0	25
27	M 25 x 1,5	1 5025 327 025	23 x 27	20,0	1 5025 328 025	22 x 27	20,0	10
36	M 32 x 1,5	1 5025 327 032	31 x 36	26,0	1 5025 328 032	29 x 36	26,0	10
45	M 40 x 1,5	1 5025 327 040	40 x 45	34,0	1 5025 328 040	38 x 45	34,0	10
56	M 50 x 1,5	1 5025 327 050	51 x 56	41,0	1 5025 328 050	49 x 56	41,0	2
		FLEXAgraff®-AS FLEXAgraff®-VA			FLEXAgraff®-PU-AS FLEXAgraff®-PU-F			
ø	Metr.	[IP 40]	mm	øI	[IP 65]	mm	øI	St.
	EN 60423			mm			mm	pcs.
17	M 16 x 1,5	1 5025 327 016	14 x 17	10,4	1 5025 328 016	13 x 17	10,4	25
21	M 20 x 1,5	1 5025 327 020	18 x 21	14,0	1 5025 328 020	17 x 21	14,0	25
27	M 25 x 1,5	1 5025 339 025	24 x 27	20,0	1 5025 340 025	23 x 27	20,0	10
36	M 32 x 1,5	1 5025 327 032	31 x 36	26,0	1 5025 328 032	29 x 36	26,0	10
45	M 40 x 1,5	1 5025 327 040	40 x 45	34,0	1 5025 328 040	38 x 45	34,0	10
56	M 50 x 1,5	1 5025 327 050	51 x 56	41,0	1 5025 328 050	49 x 56	41,0	2

🔥 IP 40 ... IP 66  
 🌡️ -40°C ... +125°C | +250°C [MSD]



## USW-M

Metall-Sicherheitsverschraubung  
 90° Winkel  
 Außengewinde  
 inkl. Innentülle, Dichtring oder  
 Messing-Druckring [MSD] und O-Ring

Metal connector, safety-type  
 90° elbow  
 outer thread  
 incl. ferrule, sealing or  
 brass thrust collar [MSD] and O-ring

### KONSTRUKTION

Verschraubungsgehäuse mit Sechskant-  
 schlüsselfläche, Anschlussgewinde  
 metrisch nach EN 60423, Sechskantdruck-  
 mutter, Kunststoff-Dichtring oder  
 Messing-Druckring, zur Aufnahme der  
 Innentülle aus Metall | Kunststoff

### STRUCTURE

Connector body with hexagonal wrench  
 surface, connecting thread metric  
 acc. to EN 60423, hexagon pressure nut,  
 plastic seal or brass thrust collar, to receive  
 FLEXA ferrule made of metal | plastics

### MATERIAL

Gehäuse                    Messing vernickelt  
 Druckmutter            Messing vernickelt  
 Dichtring                TPE oder PTFE  
 Druckring                Messing  
 Innentülle                Messing | Kunststoff  
 O-Ring                    NBR

### MATERIAL

Connector body        nickel-plated brass  
 Pressure nut            nickel-plated brass  
 Sealing ring            TPE or PTFE  
 Thrust collar            brass  
 Ferrule                    brass | plastics  
 O-ring                    NBR

### EIGENSCHAFTEN

- hoher Staub- | Flüssigkeitsschutz
- kraftschlüssige Verbindung von  
 Schlauch und Verschraubung
- einwandfreie Erdung
- Abdeckung der Schlauchenden
- vibrations- und zugfest

### PROPERTIES

- highly watertight and dustproof
- friction-type locking of conduit  
 and screw connector
- correct grounding
- covering of the conduit ends
- vibration- and tensionproof

### WICHTIG

Die Funktionssicherheit der  
 Verschraubung ist nur mit ent-  
 sprechender Innentülle gewährleistet.  
 Für EMV-Verwendung bitte die  
 Montageanleitung beachten.

### IMPORTANT

The security of the connector is only  
 guaranteed with the corresponding  
 ferrule.  
 For emc-usage please see our  
 assembly instructions.

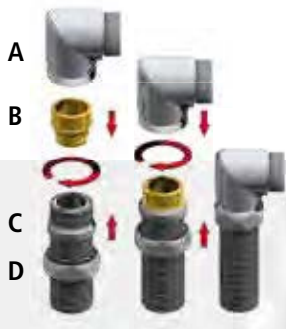
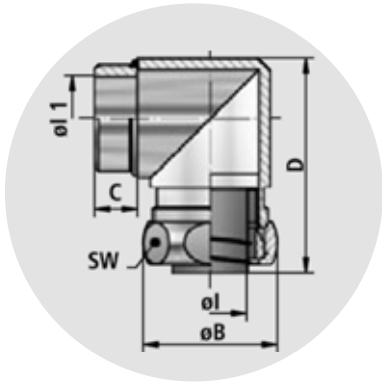

- A** Verschraubungsgehäuse  
 mit montiertem O-Ring  
 connector body with  
 mounted O-ring
- B** Innentülle  
 ferrule
- C** Dichtring oder  
 Messing-Druckring  
 sealing ring or  
 brass thrust collar
- D** Druckmutter  
 pressure nut

AD  
 OD



























Technische Basisdaten USW-M  
 Technical basic data USW-M

ø	Metr. EN 60423	øB mm	C mm	D mm	SW mm	kg 100
10	M 12 x 1,5	19,0	8,0	32,0	17	2,800
14	M 16 x 1,5	23,0	8,0	36,0	21	3,600
17	M 20 x 1,5	27,0	8,0	38,0	25	5,900
21	M 25 x 1,5	31,0	10,0	45,0	29	10,000
27	M 32 x 1,5	39,0	10,0	57,0	36	13,100
36	M 40 x 1,5	48,0	10,0	67,0	45	20,700
45	M 50 x 1,5	57,0	12,0	84,0	54	26,900
56	M 63 x 1,5	70,0	12,0	84,0	66	32,400

# USW-M

 IP 40 ... IP 66  
 -40°C ... +125°C | +250°C [MSD]

AD		FLEXA No.			FLEXA No.			
		SPR-AS SPR-VA			SPR-PA SPR-PU-F SPR-PVC-AS SPR-PU-AS			
ø	Metr.	[IP 40]	mm	øl	[IP 65]	mm	øl	St.
	EN 60423			mm			mm	pcs.
10	M 12 x 1,5	1 5010 527 012	8 x 10	6,5	1 5010 528 012	7 x 10	6,0	25
14	M 16 x 1,5	1 5010 527 016	11 x 14	10,0	1 5010 528 016	10 x 14	8,5	25
17	M 20 x 1,5	1 5010 527 020	14 x 17	12,5	1 5010 528 020	13 x 17	11,5	25
21	M 25 x 1,5	1 5010 527 025	18 x 21	16,5	1 5010 528 025	17 x 21	15,5	25
27	M 32 x 1,5	1 5010 527 032	23 x 27	21,5	1 5010 528 032	22 x 27	20,5	10
36	M 40 x 1,5	1 5010 527 040	31 x 36	29,5	1 5010 528 040	29 x 36	27,5	10
45	M 50 x 1,5	1 5010 527 050	40 x 45	38,0	1 5010 528 050	38 x 45	36,5	10
56	M 63 x 1,5	1 5010 527 063	51 x 56	48,0	1 5010 528 063	49 x 56	47,0	2
		FLEXAgraff®-AS FLEXAgraff®-VA			FLEXAgraff®-PU-AS FLEXAgraff®-PU-F			
ø	Metr.	[IP 40]	mm	øl	[IP 65]	mm	øl	St.
	EN 60423			mm			mm	pcs.
10	M 12 x 1,5	1 5010 527 012	8 x 10	6,5	1 5010 528 012	7 x 10	6,0	25
14	M 16 x 1,5	1 5010 539 016	12 x 14	10,5	1 5010 527 016	10 x 14	10,0	25
17	M 20 x 1,5	1 5010 527 020	14 x 17	12,5	1 5010 528 020	13 x 17	11,5	25
21	M 25 x 1,5	1 5010 527 025	18 x 21	16,5	1 5010 528 025	17 x 21	15,5	25
27	M 32 x 1,5	1 5010 539 032	24 x 27	22,5	1 5010 540 032	23 x 27	21,5	10
36	M 40 x 1,5	1 5010 527 040	31 x 36	29,5	1 5010 528 040	29 x 36	27,5	10
45	M 50 x 1,5	1 5010 527 050	40 x 45	38,0	1 5010 528 050	38 x 45	36,5	10
56	M 63 x 1,5	1 5010 527 063	51 x 56	48,0	1 5010 528 063	49 x 56	47,0	2
		AIRflex®-KUW-PVC-AS AIRflex®-KUW-PU-AS AIRflex®-GRS [IP 65] AIRflex®-K			FLEXAgraff®-SI-ASF			
ø	Metr.	[IP 54]	mm	øl	[IP 66]	mm	øl	St.
	EN 60423			mm			mm	pcs.
10	M 12 x 1,5	1 5010 530 012	7 x 10	6,0				25
14	M 16 x 1,5	1 5010 530 016	10 x 14	9,0	1 5010 537 016	10 x 14	9,0	25
17	M 20 x 1,5	1 5010 530 020	13 x 17	11,5	1 5010 537 020	12 x 17	10,5	25
21	M 25 x 1,5	1 5010 530 025	16 x 21	14,5	1 5010 535 025	16 x 21	14,5	25
27	M 32 x 1,5	1 5010 530 032	21 x 27	19,5	1 5010 501 032	21 x 27	19,5	10
36	M 40 x 1,5	1 5010 530 040	29 x 36	26,5	1 5010 537 040	26 x 36	26,0	10
45	M 50 x 1,5	1 5010 530 050	38 x 45	36,0	1 5010 537 050	36 x 45	34,5	10
56	M 63 x 1,5	1 5010 530 063	48 x 56	46,0	1 5010 537 063	47 x 56	45,5	2
		FLEXAgraff®-CU-AS			SPR-CU-AS SPR-EDU-AS			
ø	Metr.	[IP 40]	mm	øl	[IP 40]	mm	øl	St.
	EN 60423			mm			mm	pcs.
10	M 12 x 1,5	1 5011 528 012	7 x 10	6,0	1 5011 528 012	7 x 10	6,0	25
14	M 16 x 1,5	1 5011 527 016	11 x 14	10,0	1 5011 528 016	10 x 14	8,5	25
17	M 20 x 1,5	1 5011 528 020	13 x 17	11,5	1 5011 528 020	13 x 17	11,5	25
21	M 25 x 1,5	1 5011 528 025	17 x 21	15,5	1 5011 528 025	17 x 21	15,5	25
27	M 32 x 1,5	1 5011 540 032	23 x 27	21,5	1 5011 528 032	22 x 27	20,5	10
36	M 40 x 1,5	1 5011 528 040	29 x 36	27,5	1 5011 528 040	29 x 36	27,5	10
45	M 50 x 1,5	1 5011 528 050	38 x 45	36,5	1 5011 528 050	38 x 45	36,5	10
56	M 63 x 1,5	1 5011 528 063	49 x 56	47,0	1 5011 528 063	51 x 56	47,0	2
		AIRflex®-KUW-EDU			SPR-PVC-EDU-AS			
ø	Metr.	[IP 54]	mm	øl	[IP 54]	mm	øl	St.
	EN 60423			mm			mm	pcs.
14	M 16 x 1,5	1 5011 528 016	9 x 14	8,5	1 5011 528 016	10 x 14	8,5	25
17	M 20 x 1,5	1 5011 535 020	12 x 17	11,0	1 5011 535 020	12 x 17	11,0	25
21	M 25 x 1,5	1 5011 535 025	15 x 21	14,5	1 5011 535 025	16 x 21	14,5	25
27	M 32 x 1,5	1 5011 535 032	20 x 27	19,5	1 5011 501 032	21 x 27	19,5	10
36	M 40 x 1,5	1 5011 528 040	28 x 36	27,5	1 5011 528 040	28 x 36	27,5	10
45	M 50 x 1,5	1 5011 535 050	37 x 45	35,5	1 5011 535 050	37 x 45	35,5	10
56	M 63 x 1,5	1 5011 535 063	48 x 56	46,0	1 5011 535 063	48 x 56	46,0	2



VIDEO

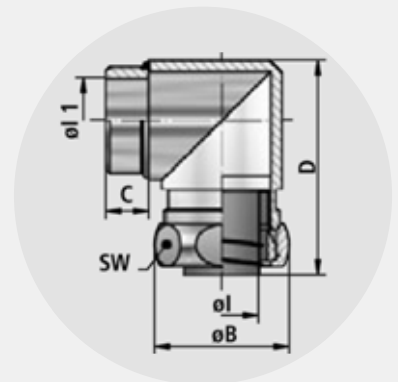

♦ IP 40 ... IP 66  
⌋ -40°C ... +125°C | +250°C [MSD]



## USW-P

Metall-Sicherheitsverschraubung  
 90° Winkel  
 Außengewinde  
 inkl. Innentülle, Dichtring oder  
 Messing-Druckring [MSD] und O-Ring

Metal connector, safety-type  
 90° elbow  
 outer thread  
 incl. ferrule, sealing or  
 brass thrust collar [MSD] and O-ring

### KONSTRUKTION

Verschraubungsgehäuse mit Sechskant-  
 schlüsselfläche, Anschlussgewinde PG  
 nach DIN 40430, Sechskant-  
 druckmutter, Kunststoff-Dichtring  
 oder Messing-Druckring, zur Aufnahme  
 der Innentülle aus Metall | Kunststoff

### STRUCTURE

Connector body with hexagonal wrench  
 surface, connecting thread PG acc. to  
 DIN 40430 hexagon pressure nut,  
 plastic seal or brass thrust collar,  
 to receive FLEXA ferrule  
 made of metal | plastics

### MATERIAL

Gehäuse	Messing vernickelt
Druckmutter	Messing vernickelt
Dichtring	TPE oder PTFE
Druckring	Messing
Innentülle	Messing   Kunststoff
O-Ring	NBR

### MATERIAL

Connector body	nickel-plated brass
Pressure nut	nickel-plated brass
Sealing ring	TPE or PTFE
Thrust collar	brass
Ferrule	brass   plastics
O-ring	NBR

### EIGENSCHAFTEN

- hoher Staub- | Flüssigkeitsschutz
- kraftschlüssige Verbindung von Schlauch und Verschraubung
- einwandfreie Erdung
- Abdeckung der Schlauchenden
- vibrations- und zugfest

### PROPERTIES

- highly watertight and dustproof
- friction-type locking of conduit and screw connector
- correct grounding
- covering of the conduit ends
- vibration- and tensionproof

### WICHTIG

Die Funktionssicherheit der Verschraubung ist nur mit entsprechender Innentülle gewährleistet. Für EMV-Verwendung bitte die Montageanleitung beachten.

### IMPORTANT

The security of the connector is only guaranteed with the corresponding ferrule. For emc-usage please see our assembly instructions.

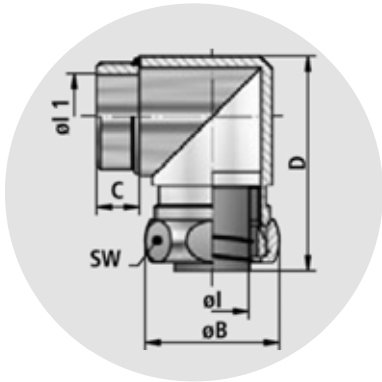

- A Verschraubungsgehäuse mit montiertem O-Ring  
connector body with mounted O-ring
- B Innentülle  
ferrule
- C Dichtring oder Messing-Druckring  
sealing ring or brass thrust collar
- D Druckmutter  
pressure nut

AD  
OD



Technische Basisdaten USW-P  
 Technical basic data USW-P

ø	PG DIN 40430	øB mm	C mm	D mm	SW mm	kg 100
10	7	19,0	9,0	36,0	17	2,800
14	9	23,0	9,0	41,0	21	3,600
17	11	27,0	8,0	45,0	25	5,900
19	13,5	29,0	10,0	49,5	27	7,700
21	16	31,0	10,0	52,0	29	10,000
27	21	39,0	10,5	58,0	36	13,400
36	29	48,0	11,0	72,0	45	23,300

# USW-P

🔥 IP 40 ... IP 66  
 🌡️ -40°C ... +125°C | +250°C [MSD]

AD  
OD



FLEXA No.



FLEXA No.



VIDEO

	SPR-AS SPR-VA		SPR-PA SPR-PU-F SPR-PVC-AS SPR-PU-AS	
--	------------------	--	-----------------------------------------------	--

ø	PG DIN 40430	[IP 40]	mm	øl mm	[IP 65]	mm	øl mm	St. pcs.
10	7	1 5010 227 007	8 x 10	6,5	1 5010 228 007	7 x 10	6,0	25
14	9	1 5010 227 009	11 x 14	10,0	1 5010 228 009	10 x 14	8,5	25
17	11	1 5010 227 011	14 x 17	12,5	1 5010 228 011	13 x 17	11,5	25
19	13,5	1 5010 227 013	16 x 19	14,5	1 5010 228 013	15 x 19	13,5	25
21	16	1 5010 227 016	18 x 21	16,5	1 5010 228 016	17 x 21	15,5	25
27	21	1 5010 227 021	23 x 27	21,5	1 5010 228 021	22 x 27	20,5	10
36	29	1 5010 227 029	31 x 36	29,5	1 5010 228 029	29 x 36	27,5	10

	FLEXAgraff®-AS FLEXAgraff®-VA		FLEXAgraff®-PU-AS FLEXAgraff®-PU-F	
--	----------------------------------	--	---------------------------------------	--

ø	PG DIN 40430	[IP 40]	mm	øl mm	[IP 65]	mm	øl mm	St. pcs.
10	7	1 5010 227 007	8 x 10	6,5	1 5010 228 007	7 x 10	6,0	25
14	9	1 5010 239 009	12 x 14	10,5	1 5010 227 009	10 x 14	10,0	25
17	11	1 5010 227 011	14 x 17	12,5	1 5010 228 011	13 x 17	11,5	25
19	13,5	1 5010 227 013	16 x 19	14,5	1 5010 228 013	15 x 19	13,5	25
21	16	1 5010 227 016	18 x 21	16,5	1 5010 228 016	17 x 21	15,5	25
27	21	1 5010 239 021	24 x 27	22,5	1 5010 240 021	23 x 27	21,5	10
36	29	1 5010 227 029	31 x 36	29,5	1 5010 228 029	29 x 36	27,5	10

	AIRflex®-KUW-PVC-AS AIRflex®-KUW-PU-AS AIRflex®-GRS [IP 65] AIRflex®-K		FLEXAgraff®-SI-ASF	
--	---------------------------------------------------------------------------------	--	--------------------	--

ø	PG DIN 40430	[IP 54]	mm	øl mm	[IP 66]	mm	øl mm	St. pcs.
10	7	1 5010 230 007	7 x 10	6,0				25
14	9	1 5010 230 009	10 x 14	9,0	1 5010 237 009	10 x 14	9,0	25
17	11	1 5010 230 011	13 x 17	11,5	1 5010 237 011	12 x 17	10,5	25
19	13,5	1 5010 230 013	15 x 19	13,0				25
21	16	1 5010 230 016	16 x 21	14,5	1 5010 235 016	16 x 21	14,5	25
27	21	1 5010 230 021	21 x 27	19,5	1 5010 201 021	21 x 27	19,5	10
36	29	1 5010 230 029	29 x 36	26,5	1 5010 237 029	27 x 36	26,5	10

	FLEXAgraff®-CU-AS		SPR-CU-AS SPR-EDU-AS	
--	-------------------	--	-------------------------	--

ø	PG DIN 40430	[IP 40]	mm	øl mm	[IP 40]	mm	øl mm	St. pcs.
10	7	1 5011 228 007	7 x 10	6,0	1 5011 228 007	7 x 10	6,0	25
14	9	1 5011 227 009	11 x 14	10,0	1 5011 228 009	10 x 14	8,5	25
17	11	1 5011 228 011	13 x 17	11,5	1 5011 228 011	13 x 17	11,5	25
19	13,5	1 5011 228 013	15 x 19	13,5	1 5011 228 013	15 x 19	13,5	25
21	16	1 5011 228 016	17 x 21	15,5	1 5011 228 016	17 x 21	15,5	25
27	21	1 5011 240 021	23 x 27	21,5	1 5011 228 021	22 x 27	20,5	10
36	29	1 5011 228 029	29 x 36	27,5	1 5011 228 029	29 x 36	27,5	10

	AIRflex®-KUW-EDU		SPR-PVC-EDU-AS	
--	------------------	--	----------------	--

ø	PG DIN 40430	[IP 54]	mm	øl mm	[IP 54]	mm	øl mm	St. pcs.
14	9	1 5011 228 009	9 x 14	8,5	1 5011 228 009	9 x 14	8,5	25
17	11	1 5011 235 011	12 x 17	11,0	1 5011 235 011	12 x 17	11,0	25
19	13,5	1 5011 235 013	14 x 19	13,0	1 5011 235 013	14 x 19	13,0	25
21	16	1 5011 235 016	15 x 21	14,5	1 5011 235 016	16 x 21	14,5	25
27	21	1 5011 235 021	20 x 27	19,5	1 5011 201 021	21 x 27	19,5	10
36	29	1 5011 228 029	28 x 36	27,5	1 5011 228 029	28 x 36	27,5	10



IP 54  
-10°C ... +110°C

UL 1696  
UR file E86359  
CSA 22.2  
File No. 227.3-05



## USK

Kunststoffverschraubung  
gerade  
Außengewinde  
inkl. Innentülle und Dichtring  
UL-file E86359

Plastic connector  
straight  
outer thread  
incl. ferrule and sealing  
UL-file E86359

### KONSTRUKTION

Verschraubungsgehäuse mit Sechskant-schlüsselfläche und Anschlussgewinde

### STRUCTURE

Connector body with hexagonal wrench surface and connecting thread

### MATERIAL

Gehäuse Kunststoff [PP]  
Innentülle Kunststoff [PP]  
Dichtring TPE

### MATERIAL

Connector body plastics [PP]  
Ferrule plastics [PP]  
Sealing ring TPE

### EIGENSCHAFTEN

- hoher Staub- und Flüssigkeitsschutz
- kraftschlüssige Verbindung von Schlauch und Verschraubung
- vibrations- und zugfest

### PROPERTIES

- high dust- and waterproof
- friction-type locking of conduit and screw connector
- vibration and tension-proof

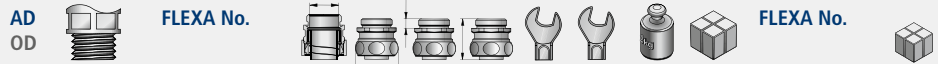
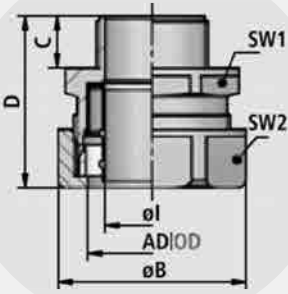

### USK-M

AIRflex-KUW-PVC-AS  
AIRflex-KUW-PU-AS  
AIRflex-K  
AIRflex-GRS

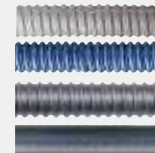

Kleine VPE  
small packing unit

ø	Metr. EN 60423	[IP 54]	øl mm	øB mm	C mm	D mm	SW1 mm	SW2 mm	kg 100	St. pcs.	St. pcs.	
10	M 10 x 1,0	1 5020 330 010	6,0	20,0	10,0	40,0	16	18	0,340	50	1 5020 730 010	10
14	M 12 x 1,5	1 5020 330 012	8,0	25,0	12,0	43,0	21	23	0,660	50	1 5020 730 012	10
17	M 16 x 1,5	1 5020 330 016	11,0	30,0	12,0	43,0	24	27	0,880	50	1 5020 730 016	10
21	M 20 x 1,5	1 5020 330 020	15,0	35,0	13,0	44,0	29	32	1,220	50	1 5020 730 020	10
27	M 25 x 1,5	1 5020 330 025	19,0	44,0	13,0	50,0	36	40	2,400	25	1 5020 730 025	10
36	M 32 x 1,5	1 5020 330 032	27,0	54,0	15,0	51,0	45	49	3,120	25	1 5020 730 032	2
45	M 40 x 1,5	1 5020 330 040	35,0	63,0	15,0	51,0	54	58	3,920	25	1 5020 730 040	2
56	M 50 x 1,5	1 5020 330 050	44,5	77,0	16,0	58,0	66	70	6,200	10	1 5020 730 050	2
56	M 63 x 1,5	1 5020 330 063	44,5	77,0	16,0	58,0	66	70	8,800	10	1 5020 730 063	2

### USK-P

Kleine VPE  
small packing unit

ø	PG DIN 40430	[IP 54]	øl mm	øB mm	C mm	D mm	SW1 mm	SW2 mm	kg 100	St. pcs.	St. pcs.	
10	7	1 5020 130 007	6,0	20,0	10,0	40,0	16	18	0,350	50	1 5020 430 007	10
14	9	1 5020 130 009*	9,0	25,0	10,0	41,0	21	23	0,640	50	1 5020 430 009*	10
17	11	1 5020 130 011*	11,0	30,0	10,0	41,0	24	27	0,860	50	1 5020 430 011*	10
19	13,5	1 5020 130 013	13,0	32,0	10,0	41,0	26	29	0,980	50	1 5020 430 013	10
21	16	1 5020 130 016*	14,5	35,0	11,0	42,0	29	32	1,180	50	1 5020 430 016*	10
27	21	1 5020 130 021	19,5	44,0	11,0	48,0	36	40	2,240	25	1 5020 430 021	10
36	29	1 5020 130 029	27,0	54,0	12,0	48,0	45	49	3,120	25	1 5020 430 029	2
45	36	1 5020 130 036	36,0	63,0	12,0	48,0	53	58	4,040	25	1 5020 430 036	2
56	48	1 5020 130 048	46,0	77,0	15,0	57,0	65	70	6,300	10	1 5020 430 048	2

\* mit NEMKO-Approbation with NEMKO-Approval



- A Verschraubungsgehäuse mit montiertem O-Ring  
connector body with mounted O-ring
- B Innentülle  
ferrule
- C Dichtring  
sealing ring
- D Druckmutter  
pressure nut



# LKI

Kunststoffverschraubung  
gerade  
einteilig  
mit Anschlussgewinde drehbar  
UL-file E86359

Plastic connector  
straight  
one-part  
with turnable connecting thread  
UL-file E86359

IP 54  
-10°C ... +110°C

UL 1696  
UR file E86359  
CSA 22.2  
File No. 227.3-05



## KONSTRUKTION

Rundes Verschraubungsgehäuse  
drehbares Anschlussgewinde mit  
integrierter Innentülle

## STRUCTURE

Round connector body  
turnable connecting thread  
with fixed ferrule

## MATERIAL

schlagfester Kunststoff [PP]

## MATERIAL

resistant plastics [PP]

## EIGENSCHAFTEN

- rationelle Schlauchmontage
- einteiliger Verschraubungskörper  
Schlauchausdrehschutz
- Abdeckung der Schlauchenden
- vibrations- und zugfest

## PROPERTIES

- rational conduit fitting
- one-part connector body
- conduit screw-out-locking
- covering of the conduit ends
- vibrationproof and tensionproof



AD  
OD



FLEXA No.

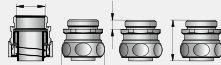

FLEXA No.



## LKI-M

AIRflex-KUW-PVC-AS  
AIRflex-KUW-PU-AS  
AIRflex-K  
AIRflex-GRS



Kleine VPE  
small packing unit

ø	Metr. EN 60423	[IP 54]	øI mm	øB mm	C mm	D mm	SW mm	kg 100	St. pcs.	FLEXA No.	St. pcs.
10	M 12 x 1,5	1 5020 014 012	5,5	17,5	10,0	38,0	16	0,260	50	1 5020 714 012	10
14	M 16 x 1,5	1 5020 014 016	9,5	21,0	10,0	39,5	19	0,380	50	1 5020 714 016	10
17	M 20 x 1,5	1 5020 014 020	11,5	24,5	10,0	42,0	22	0,640	50	1 5020 714 020	10
21	M 25 x 1,5	1 5020 014 025	14,5	30,0	11,0	48,0	27	0,980	50	1 5020 714 025	10
27	M 32 x 1,5	1 5020 014 032	19,5	39,0	12,0	58,0	35	1,680	25	1 5020 714 032	10
36	M 40 x 1,5	1 5020 014 040	27,0	50,0	12,0	59,0	45	2,560	25	1 5020 714 040	2
45	M 50 x 1,5	1 5020 014 050	35,5	59,5	12,0	62,5	54	3,520	25	1 5020 714 050	2
56	M 63 x 1,5	1 5020 014 063	46,0	71,5	15,0	68,0	65	5,900	10	1 5020 714 063	2

## LKI-P

ø	PG DIN 40430	[IP 54]	øI mm	øB mm	C mm	D mm	SW mm	kg 100	St. pcs.	FLEXA No.	St. pcs.
10	7	1 5020 010 007	5,5	17,5	10,0	38,0	16	0,300	50	1 5020 710 007	10
14	9	1 5020 010 009	9,5	21,0	10,0	39,5	19	0,340	50	1 5020 710 009	10
17	11	1 5020 010 011	11,5	24,5	10,0	42,0	22	0,600	50	1 5020 710 011	10
19	13,5	1 5020 010 013	13,0	26,5	10,0	42,0	24	0,660	50	1 5020 710 013	10
21	16	1 5020 010 016	14,5	30,0	11,0	48,0	27	0,920	50	1 5020 710 016	10
27	21	1 5020 010 021	19,5	39,0	11,0	58,0	35	1,720	25	1 5020 710 021	10
36	29	1 5020 010 029	27,0	50,0	12,0	59,0	45	2,800	25	1 5020 710 029	2
45	36	1 5020 010 036	35,5	59,5	12,0	62,5	54	3,680	25	1 5020 710 036	2
56	48	1 5020 010 048	46,0	71,5	15,0	68,0	65	5,800	10	1 5020 710 048	2

\* mit NEMKO-Approbaton with NEMKO-Approval

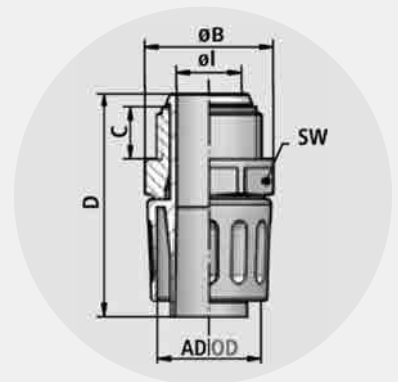

IP 68 | IP 69K  
-40°C ... +125°C

ECOLAB



VIDEO

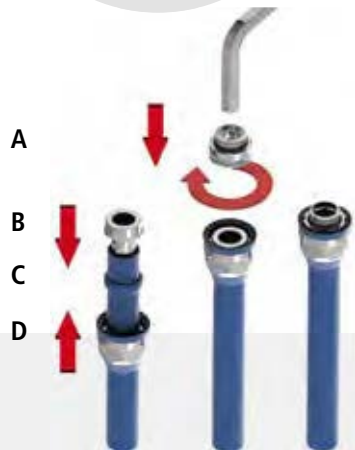
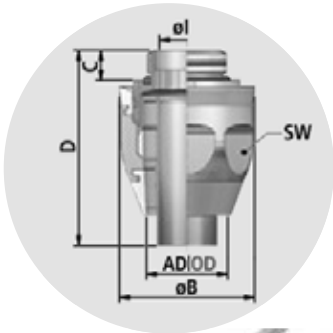

- A Verschraubungskörper mit montiertem O-Ring  
connector body with mounted O-ring
- B Innentülle  
ferrule
- C Dichtring  
sealing ring
- D Druckmutter  
pressure nut

## US – FOOD

Metallverschraubung  
Edelstahl  
gerade  
Außengewinde  
inkl. Innentülle und O-ring

Metal connector  
stainless steel  
straight  
outer thread  
incl. ferrule and sealing

### KONSTRUKTION

Verschraubungsgehäuse mit Sechskant-schlüsselfläche, feststehendes Außen-gewinde metrisch nach EN 60423, Sechskantdruckmutter, Kunststoff-Dichtring, einteilige Gewinde-Innentülle und O-Ring

### STRUCTURE

Connector body with hexagon wrench surface, fixed connecting outer thread metric acc to EN 60423, hexagon pressure nut, plastic sealing, one-part thread ferrule and O-Ring

### MATERIAL

Gehäuse Edelstahl|Versaflex CL2250  
Druckmutter Edelstahl 1.4404  
Dichtring Kunststoff PA 6  
Innentülle Messing  
O-Ring NBR

### MATERIAL

Conn. Body stainless steel|Versaflex CL2250  
Pressure nut stainless steel 1.4404  
Sealing ring plastics PA 6  
Ferrule nickel-plated brass  
O-ring NBR

### EIGENSCHAFTEN

- lebensmittelecht
- hoher Staub- und Flüssigkeitsschutz
- kraftschlüssige Verbindung von Schlauch und Verschraubung
- einwandfreie Erdung
- Abdeckung der Schlauchenden
- vibrations- und zugfest
- IP 68 geprüft nach EN 60529 | IP 69K geprüft nach DIN 40050-9 [interne Prüfung] bis 40 bar, 80°C

### PROPERTIES

- food-safe
- highly watertight and dustproof
- friction-type locking of conduit and screw connector
- correct grounding
- covering of the conduit ends
- vibration- and tension proof
- IP 68 approved acc. to EN 60529 | IP 69K approved acc. to DIN 40050-9 [internal audit] up to 40 bar, 80°C

AD OD FLEXA No.

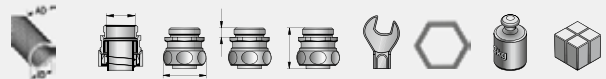

## US – FOOD – M

LIQUID – TIGHT – FOOD

ø	Metr. EN 60423	[IP 68]	mm	øl mm	øB mm	C mm	D mm	SW mm	SW mm	kg 100	St. pcs.
1/2"	M 20 x 1,5	1 0608 800 020	16,0 x 21,0	14,0	34,0	7,5	48,5	30	14	7,040	10
1/2"	M 25 x 1,5	1 0608 800 125	16,0 x 21,0	14,0	41,0	7,5	49,5	36	14	11,510	10
3/4"	M 25 x 1,5	1 0608 800 025	21,0 x 27,0	18,8	41,0	7,5	58,0	36	19	10,010	5
1"	M 32 X 1,5	1 0608 800 032	26,5 x 33,0	27,8	53,0	7,5	68,0	46	25	19,325	5
1 1/4"	M 40 X 1,5	1 0608 800 040	35,0 x 42,0	32,0	61,0	7,5	80,0	54	32	29,295	2

# EG

Metallverschraubung  
gerade  
Außengewinde  
inkl. Innentülle und Dichtring

Metal connector  
straight  
outer thread  
incl. ferrule and sealing

IP 67  
-45°C ... +105°C

## KONSTRUKTION

Verschraubungsgehäuse mit Sechskant-schlüsselfläche, feststehendes Anschluss-gewinde, Sechskantdruckmutter, Kunst-stoff-Dichtring, einteilige Gewinde-Innen-tülle, abgestimmt auf die amerikanischen und kanadischen Handelsgrößen

## STRUCTURE

Connector body, hexagon wrench surface, connecting thread with hexagon pressure nut, plastic sealing and one-part thread ferrule, according to US and Canadian commercial sizes

## MATERIAL

Gehäuse Messing vernickelt  
Druckmutter Messing vernickelt  
Dichtring Elastischer Kunststoff  
Innentülle Messing

## MATERIAL

Connector body nickel-plated brass  
Pressure nut nickel-plated brass  
Sealing ring elastic plastics  
Ferrule brass

## EIGENSCHAFTEN

- hoher Staub- und Flüssigkeitsschutz
- kraftschlüssige Verbindung von Schlauch und Verschraubung
- einwandfreie Erdung
- Abdeckung der Schlauchenden

## PROPERTIES

- highly watertight and dustproof
- friction-type locking of conduit and connector
- correct grounding
- covering of the conduit ends



AD  
OD



FLEXA No.



## EG-M

LIQUID-TIGHT-EF  
LIQUID-TIGHT-EF-OR  
LIQUID-TIGHT-UL-CSA

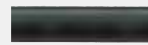

ø	Metr. EN 60423	[IP 67]	mm	øl mm	øB mm	C mm	D mm	SW 1 mm	SW 2 mm	kg 100	St. pcs.
1/4"	M 12 x 1,5	1 0608 000 012	7,0 x 11,4	5,2	24,5	10,0	33,0	22	20	4,800	10
5/16"	M 16 x 1,5	1 0608 000 116	10,0 x 14,5	8,3	29,0	12,0	35,0	26	24	4,800	10
3/8"	M 16 x 1,5	1 0608 000 016	12,5 x 18,0	10,2	29,0	12,0	35,0	26	24	4,800	10
5/16"	M 20 x 1,5	1 0608 000 120	10,0 x 14,5	8,3	29,0	13,0	36,0	26	24	5,100	10
3/8"	M 20 x 1,5	1 0608 000 020	12,5 x 18,0	10,2	29,0	13,0	36,0	26	24	5,100	10
1/2"	M 20 x 1,5	1 0608 000 021	16,0 x 21,0	13,9	32,7	13,0	37,0	29	27	5,900	10
3/4"	M 25 x 1,5	1 0608 000 025	21,0 x 26,5	18,5	38,7	15,0	40,0	35	33	7,900	5
1"	M 32 x 1,5	1 0608 000 032	26,5 x 33,0	23,8	50,0	15,0	46,0	45	43	17,500	5
1 1/4"	M 40 x 1,5	1 0608 000 040	35,5 x 42,0	31,8	60,0	16,0	52,0	54	52	27,900	2
2"	M 63 x 1,5	1 0608 000 063	51,5 x 60,0	47,8	85,0	20,0	66,0	77	74	73,500	2

## EG-P

ø	PG DIN 40430	[IP 67]	mm	øl mm	øB mm	C mm	D mm	SW 1 mm	SW 2 mm	kg 100	St. pcs.
1/4"	7	1 0610 000 007	7,0 x 11,4	5,2	24,5	10,0	33,0	22	20	3,000	10
5/16"	9	1 0610 000 009	10,0 x 14,5	8,3	29,0	12,0	35,0	26	24	4,800	10
3/8"	11	1 0610 000 011	12,5 x 18,0	10,2	29,0	12,0	35,0	26	24	5,520	10
3/8"	13,5	1 0610 000 013	12,5 x 18,0	10,2	29,0	12,0	35,0	26	24	5,320	10
1/2"	16	1 0610 000 016	16,0 x 21,0	13,9	32,7	13,0	37,0	29	27	8,080	10
3/4"	21	1 0610 000 021	21,0 x 26,5	18,5	38,7	15,0	40,0	35	33	11,800	5
1"	29	1 0610 000 029	26,5 x 33,0	23,8	50,0	15,0	46,0	45	43	20,600	5
1 1/4"	36	1 0610 000 036	35,5 x 42,0	31,8	60,0	16,0	52,0	54	52	38,800	2
2"	48	1 0610 000 048	51,5 x 60,0	47,8	85,0	20,0	66,0	77	74	66,000	2

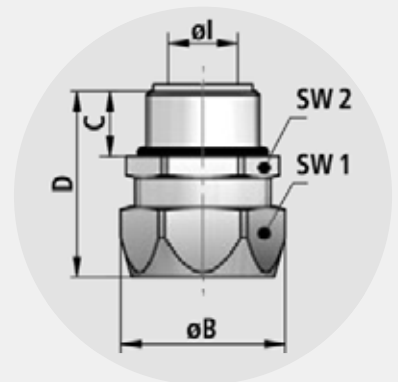

IP 67  
-45°C ... +105°C

## EW 45

Metallverschraubung  
Winkel 45°  
Außengewinde  
inkl. Innentülle und Dichtung

Metal connector  
elbow 45°  
outer thread  
incl. ferrule and sealing

### KONSTRUKTION

Verschraubungsgehäuse in 45° Winkel-  
ausführung mit Sechskantschlüsselfläche,  
feststehendes Anschlussgewinde,  
Sechskantdruckmutter, Kunststoff-  
Dichtring, einteilige Gewinde-Innentülle,  
abgestimmt auf die amerikanischen und  
kanadischen Handelsgrößen

### STRUCTURE

Connector body of 45°-angle version,  
hexagon wrench surface  
with conduit connecting thread,  
hexagon pressure nut, plastic sealing,  
one-part thread ferrule, according to  
US and Canadian commercial sizes

### MATERIAL

Gehäuse Messing vernickelt  
Druckmutter Messing vernickelt  
Dichtring Elastischer Kunststoff  
Innentülle Messing

### MATERIAL

Connector body nickel-plated brass  
Pressure nut nickel-plated brass  
Sealing ring elastic plastics  
Ferrule brass

### EIGENSCHAFTEN

- hoher Staub- und Flüssigkeitsschutz
- kraftschlüssige Verbindung von  
Schlauch und Verschraubung
- einwandfreie Erdung
- Abdeckung der Schlauchenden

### PROPERTIES

- highly watertight and dustproof
- friction-type locking of conduit  
and screw connector
- correct grounding
- covering of the conduit ends

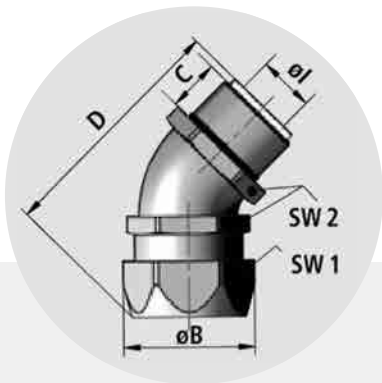

AD  
OD



FLEXA No.



### EW 45 – M

LIQUID-TIGHT-EF  
LIQUID-TIGHT-EF-OR  
LIQUID-TIGHT-UL-CSA

ø	Metr. EN 60423	[IP 67]	mm	øl mm	øB mm	C mm	D mm	SW 1 mm	SW 2 mm	kg 100	St. pcs.
5/16"	M 16 x 1,5	1 0609 000 116	10,0 x 14,5	8,3	29,0	12,0	57,0	26	22	7,300	10
3/8"	M 16 x 1,5	1 0609 000 016	12,5 x 18,0	10,2	29,0	12,0	57,0	26	22	7,300	10
5/16"	M 20 x 1,5	1 0609 000 120	10,0 x 14,5	8,3	29,0	13,0	57,0	26	22	7,400	10
3/8"	M 20 x 1,5	1 0609 000 020	12,5 x 18,0	10,2	29,0	12,0	58,0	26	22	7,400	10
1/2"	M 20 x 1,5	1 0609 000 021	16,0 x 21,0	13,9	32,7	13,0	60,0	29	27	10,500	10
3/4"	M 25 x 1,5	1 0609 000 025	21,0 x 26,5	18,5	38,7	15,0	70,0	35	33	13,600	5
1"	M 32 x 1,5	1 0609 000 032	26,5 x 33,0	23,8	50,0	15,0	84,5	45	42	26,500	5
1 1/4"	M 40 x 1,5	1 0609 000 040	35,5 x 42,0	31,8	60,0	16,0	98,0	54	51	44,900	2
2"	M 63 x 1,5	1 0609 000 063	51,5 x 60,0	47,8	85,0	20,0	133,5	77	74	128,000	2

### EW 45 – P

ø	PG DIN 40430	[IP 67]	mm	øl mm	øB mm	C mm	D mm	SW 1 mm	SW 2 mm	kg 100	St. pcs.
5/16"	11	1 0611 000 111	10,0 x 14,5	8,3	29,0	12,0	57,0	26	22	7,700	10
3/8"	11	1 0611 000 011	12,5 x 18,0	10,2	29,0	12,0	57,0	26	22	7,700	10
5/16"	13,5	1 0611 000 113	10,0 x 14,5	8,3	29,0	12,0	57,0	26	22	8,100	10
3/8"	13,5	1 0611 000 013	12,5 x 18,0	10,2	29,0	12,0	57,0	26	22	8,100	10
1/2"	16	1 0611 000 016	16,0 x 21,0	13,9	32,7	13,0	60,0	29	27	11,600	10
3/4"	21	1 0611 000 021	21,0 x 26,5	18,5	38,7	15,0	70,0	35	33	16,600	5
1"	29	1 0611 000 029	26,5 x 33,0	23,8	50,0	15,0	75,0	45	42	31,500	5
1 1/4"	36	1 0611 000 036	35,5 x 42,0	31,8	60,0	16,0	98,0	54	51	53,200	2
2"	48	1 0611 000 048	51,5 x 60,0	47,8	85,0	20,0	134,0	77	74	132,000	2

## EW 90

Metallverschraubung  
Winkel 90°  
Außengewinde  
inkl. Innentülle und Dichtring

Metal connector  
elbow 90°  
outer thread  
incl. ferrule and sealing

IP 67  
-45°C ... +105°C

### KONSTRUKTION

Verschraubungsgehäuse in 90° Winkel-  
ausführung mit Sechskantschlüsselfläche,  
feststehendes Anschlussgewinde,  
Sechskantdruckmutter, Kunststoff-  
Dichtring, einteilige Gewinde-Innentülle,  
abgestimmt auf die amerikanischen und  
kanadischen Handelsgrößen

### STRUCTURE

Connector body of 45°-angle version  
hexagon wrench surface with  
conduit connecting thread,  
hexagon pressure nut, plastic sealing,  
one-part thread ferrule, according to  
US and Canadian commercial sizes

### MATERIAL

Gehäuse Messing vernickelt  
Druckmutter Messing vernickelt  
Dichtring Elastischer Kunststoff  
Innentülle Messing

### MATERIAL

Connector body nickel-plated brass  
Pressure nut nickel-plated brass  
Sealing ring elastic plastics  
Ferrule brass

### EIGENSCHAFTEN

- hoher Staub- und Flüssigkeitsschutz
- kraftschlüssige Verbindung von  
Schlauch und Verschraubung
- einwandfreie Erdung
- Abdeckung der Schlauchenden

### PROPERTIES

- highly watertight and dustproof
- friction-type locking of conduit  
and screw connector
- correct grounding
- covering of the conduit ends



AD  
OD



FLEXA No.



### EW 90-M

LIQUID-TIGHT-EF  
LIQUID-TIGHT-EF-OR  
LIQUID-TIGHT-UL-CSA

ø	Metr. EN 60423	[IP 67]	øI mm	øB mm	C mm	D mm	SW 1 mm	SW 2 mm	kg 100	St. pcs.	
5/16"	M 16 x 1,5	1 0607 000 116	10,0 x 14,5	8,3	29,0	12,0	57,0	26	22	8,200	10
3/8"	M 16 x 1,5	1 0607 000 016	12,5 x 18,0	10,2	29,0	12,0	49,0	26	22	8,200	10
5/16"	M 20 x 1,5	1 0607 000 120	10,0 x 14,5	8,3	29,0	13,0	57,0	26	22	8,400	10
3/8"	M 20 x 1,5	1 0607 000 020	12,5 x 18,0	10,2	29,0	13,0	49,0	26	22	8,400	10
1/2"	M 20 x 1,5	1 0607 000 021	16,0 x 21,0	13,9	32,7	13,0	54,0	29	27	12,600	10
3/4"	M 25 x 1,5	1 0607 000 025	21,0 x 26,5	18,5	38,7	15,0	65,0	35	33	19,200	5
1"	M 32 x 1,5	1 0607 000 032	26,5 x 33,0	24,3	50,0	15,0	75,0	45	42	31,600	5
1 1/4"	M 40 x 1,5	1 0607 000 040	35,5 x 42,0	31,8	60,0	16,0	90,0	54	51	56,100	2
2"	M 63 x 1,5	1 0607 000 063	51,5 x 60,0	47,8	85,0	20,0	120,0	77	74	139,800	2

### EW 90-P

ø	PG DIN 40430	[IP 67]	øI mm	øB mm	C mm	D mm	SW 1 mm	SW 2 mm	kg 100	St. pcs.	
5/16"	11	1 0612 000 111	10,0 x 14,5	8,3	29,0	12,0	48,0	26	22	8,900	10
3/8"	11	1 0612 000 011	12,5 x 18,0	10,2	29,0	12,0	49,0	26	22	8,900	10
5/16"	13,5	1 0612 000 113	10,0 x 14,5	10,5	29,0	12,0	49,0	26	22	8,900	10
3/8"	13,5	1 0612 000 013	12,5 x 18,0	10,2	29,0	12,0	49,0	26	22	8,900	10
1/2"	16	1 0612 000 016	16,0 x 21,0	13,9	32,7	13,0	54,0	29	27	13,500	10
3/4"	21	1 0612 000 021	21,0 x 26,5	18,5	38,7	15,0	65,0	35	33	21,600	5
1"	29	1 0612 000 029	26,5 x 33,0	23,8	50,0	15,0	75,0	45	42	35,300	5
1 1/4"	36	1 0612 000 036	35,5 x 42,0	31,8	60,0	16,0	90,0	54	51	62,500	2
2"	48	1 0612 000 048	51,5 x 60,0	47,8	85,0	20,0	120,0	77	74	141,900	1

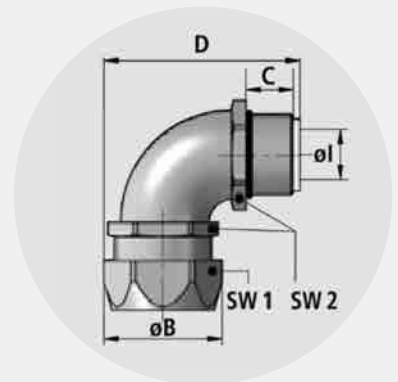



## NIMS

Metall-Schlaucholive  
Sechskantschlüsselfläche  
feststehendes Anschlussgewinde  
inkl. O-Ring





🔥 IP 54 ... IP 68  
🌡️ -40°C ... +250°C

Metal conduit olive  
hexagon wrench surface  
fixed outer thread  
incl. O-Ring

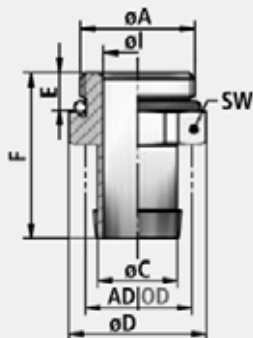
**MATERIAL**  
Messing vernickelt

**MATERIAL**  
nickel-plated brass



AD OD  **FLEXA No.**   

### NIMS-M



K-EDU  
K-Schlauch



HG-CU | HG-CU-F  
HG-CU-K  
FLEXAhightemp

ø	Metr. EN 60423	FLEXA No.	øl mm	øC mm	øD mm	E mm	F mm	SW mm	kg 100	St. pcs.
14	M 12 x 1,5	1 5010 023 012	7,0	9,0	15,5	6,4	29,0	14	1,380	10
17	M 16 x 1,5	1 5010 023 016	10,0	12,0	19,0	6,5	29,0	17	2,300	10
19	M 20 x 1,5	1 5010 023 020	12,0	14,0	24,3	6,5	29,0	22	3,400	10
21	M 25 x 1,5	1 5010 023 025	14,0	16,0	30,1	6,5	29,0	27	4,400	10
27	M 32 x 1,5	1 5010 023 032	19,0	21,0	39,1	6,5	32,1	35	8,600	5
36	M 40 x 1,5	1 5010 023 040	27,0	29,0	51,0	7,5	39,0	43	10,800	5
45	M 50 x 1,5	1 5010 023 050	35,0	37,1	59,5	10,0	47,0	54	15,000	5
56	M 63 x 1,5	1 5010 023 063	46,0	54,0	70,0	10,0	50,1	65	33,000	5

### NIMS-P

ø	PG DIN 40430	FLEXA No.	øl mm	øC mm	øD mm	E mm	F mm	SW mm	kg 100	St. pcs.
14	9	1 5010 022 009	7,0	9,0	21,0	6,0	29,0	19	2,120	10
17	11	1 5010 022 011	10,0	12,0	24,0	6,0	29,0	22	3,200	10
19	13,5	1 5010 022 013	12,0	14,0	24,0	6,0	29,0	24	2,940	10
21	16	1 5010 022 016	14,0	16,0	26,0	6,0	29,0	24	3,500	10
27	21	1 5010 022 021	19,0	21,0	35,5	6,0	29,0	32	5,000	5
36	29	1 5010 022 029	27,0	29,0	44,0	8,0	39,0	41	13,930	5
45	36	1 5010 022 036	34,0	36,0	54,0	9,0	41,0	50	14,200	5

## SGL

Schlauchschelle  
passend zu Schlaucholive NIMS



🌡️ -40°C ... +120°C

Conduit clamp  
suitable for conduit olive NIMS

**MATERIAL**  
Stahlblech verzinkt

**MATERIAL**  
galvanized steel



AD OD **FLEXA No.** **Klemmbereich**  
fixing range **Breite**  
width  

### SGL

ø	FLEXA No.	Klemmbereich fixing range	Breite width	kg 100	St. pcs.
14 - 17	1 0340 000 020	12 - 20	9,0	1,400	10
19 - 21	1 0340 000 025	16 - 25	9,0	1,500	10
27 - 36	1 0340 000 040	25 - 40	9,0	1,700	10
45 - 56	1 0340 000 060	40 - 60	9,0	2,600	10

## MSD

Messing-Druckring  
für Verschraubungen US

### MATERIAL

Messing

### VERWENDUNG

- zur Erdung
- als Potentialausgleich für Schlauch-Verschraubungs-kombinationen im EMV-Einsatz

🔥 ... +250°C

Brass thrust collar  
for connectors US

### MATERIAL

brass

### APPLICATION

- for grounding
- as potential equalization by use of conduits with metal braiding for shielding applications



AD  
OD FLEXA No.

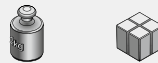

### MSD

ø		øD mm	ød mm	L mm	kg 100	St. pcs.
10	1 5031 034 007	13,0	10,2	5,0	0,160	50
14	1 5031 034 009	17,0	14,5	5,0	0,180	50
17	1 5031 034 011	21,0	17,2	5,0	0,320	50
19	1 5031 034 013	23,0	19,2	6,0	0,360	50
21	1 5031 034 016	25,0	21,3	6,0	0,400	50
27	1 5031 034 021	32,0	27,3	8,5	1,240	25
36	1 5031 034 029	41,0	36,3	8,5	1,400	25
45	1 5031 034 036	50,0	45,3	8,5	1,760	20
56	1 5031 034 048	61,0	56,3	8,5	2,200	10

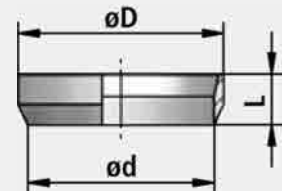

## TED

Dichtring  
für Typ  
US | FLEXAgraft®-SI-ASF

### MATERIAL

PTFE

🔥 -60°C ... +300°C

Sealing ring  
for type  
US | FLEXAgraft®-SI-ASF

### MATERIAL

PTFE



AD  
OD FLEXA No.

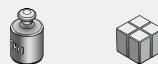

### TED

ø		øD mm	ød mm	L mm	kg 100	St. pcs.
10	1 5030 013 010	13,0	10,3	6,0	0,054	50
14	1 5030 013 014	17,0	14,3	6,0	0,070	50
17	1 5030 013 017	21,0	17,3	6,0	0,120	50
21	1 5030 013 021	25,0	21,3	7,0	0,160	50
27	1 5030 013 027	32,0	27,4	9,5	0,400	25
36	1 5030 013 036	41,0	36,4	9,5	0,480	25
45	1 5030 013 045	50,0	45,4	9,5	0,600	20
56	1 5030 013 056	61,0	56,5	9,5	0,800	10

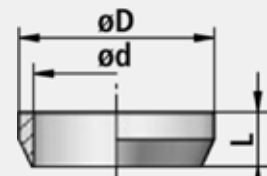

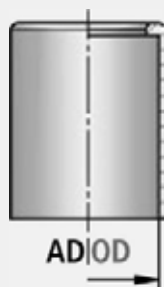

## EK

🔥 -10°C ... +110°C

Zylindrische Kunststoff-Endtülle mit nach innen gezogenem Schutzrand zur Abdeckung der Schlauchenden

Cylindric plastic terminal sleeve with protective edges to cover the conduit ends

### MATERIAL

Polypropylen

### MATERIAL



polypropylene

### VERWENDUNG

- für alle Schlauchtypen aus Metall und Kunststoff

### APPLICATION

- for all protective conduit types made of metal and plastic

AD OD	FLEXA No.			
<b>EK</b>	grau grey			
ø		mm	kg 100	St. pcs.
10	1 5020 021 007	10,0	0,060	50
14	1 5020 021 009	14,0	0,120	50
17	1 5020 021 011	17,0	0,150	50
19	1 5020 021 013	19,0	0,155	50
21	1 5020 021 016	21,0	0,170	50
27	1 5020 021 021	27,0	0,340	25
36	1 5020 021 029	36,0	0,890	25
45	1 5020 021 036	45,0	0,960	25
56	1 5020 021 048	56,0	1,400	10

## AK

🔥 -40°C ... +120°C ^ +150°C

Endtülle | Übergangsstelle von Schlauch zu Kabel

End cap | transition from tubing to cable

### MATERIAL

TPE

### MATERIAL

TPE



### EIGENSCHAFTEN

- rationeller Schlauchendenabschluss, durch einfaches Aufstecken montiert
- aufsteckbar auf alle Schutzschläuche
- silikon-, cadmium-, halogenfrei
- selbstverlöschend

### PROPERTIES

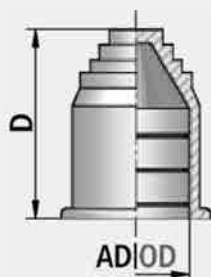
- easy mounting cap
- easy to plug on all protective conduits
- free of silicone-, cadmium-, halogen
- self-extinguishing



AD OD	FLEXA No.				
<b>AK</b>	schwarz black				
ø		min ø - max ø mm	D mm	kg 100	St. pcs.
10	1 5030 014 207	1,0 - 8,0	29,0	0,160	50
14	1 5030 014 209	1,0 - 10,0	32,5	0,220	50
17	1 5030 014 211	4,0 - 12,0	35,5	0,340	50
21	1 5030 014 216	6,0 - 16,5	37,5	0,560	50
27	1 5030 014 221	6,0 - 23,0	40,2	0,800	25
36	1 5030 014 229*	6,0 - 29,0	44,2	1,480	25
45	1 5030 014 236*	10,0 - 37,0	45,5	1,480	25
56	1 5030 014 248*	10,0 - 47,0	52,5	2,200	10

\* Lieferzeit auf Anfrage Delivery time on request



# EEM

🌡️ -40°C ... +250°C

Endtülle | Innentülle

Terminal sleeve | ferrule

## MATERIAL

Messing - für ummantelte Schutzschläuche  
 Messing vernickelt - für nicht ummantelte Schutzschläuche

## MATERIAL

brass - for conduits with sheathing  
 nickel-plated brass - for conduits without sheathing

## VERWENDUNG

- für US- und USW-Verschraubungen
- als Endtülle an Schutzschläuchen

## APPLICATION

- for connectors US and USW
- as terminal sleeve for protective conduits



AD	FLEXA No.	FLEXA No.	FLEXA No.	FLEXA No.	FLEXA No.
OD					
	SPR-AS SPR-VA	SPR-PA SPR-PU-F SPR-PVC-AS SPR-PU-AS SPR-EDU-AS SPR-CU-AS		FLEXAgraff®-AS FLEXAgraff®-VA	

ø		øl		øl		øl	kg 100	St.			
	mm	mm	mm	mm	mm	mm		pcs.			
10	1 5031 027 007	8 x 10	6,5	1 5031 028 007	7 x 10	6,0	1 5031 027 007	8 x 10	6,5	0,160	50
14	1 5031 027 009	11 x 14	10,0	1 5031 028 009	10 x 14	8,5	1 5031 039 009	12 x 14	10,5	0,300	50
17	1 5031 027 011	14 x 17	12,5	1 5031 028 011	13 x 17	11,5	1 5031 027 011	14 x 17	12,5	0,320	50
19	1 5031 027 013	16 x 19	14,5	1 5031 028 013	15 x 19	13,5	1 5031 027 013	16 x 19	14,5	0,420	50
21	1 5031 027 016	18 x 21	16,5	1 5031 028 016	17 x 21	15,5	1 5031 027 016	18 x 21	16,5	0,520	50
27	1 5031 027 021	23 x 27	21,5	1 5031 028 021	22 x 27	20,5	1 5031 039 021	24 x 27	23,0	1,120	25
36	1 5031 027 029	31 x 36	29,5	1 5031 028 029	29 x 36	27,5	1 5031 027 029	31 x 36	29,5	1,640	25
45	1 5031 027 036	40 x 45	38,0	1 5031 028 036	38 x 45	36,5	1 5031 027 036	40 x 45	38,0	2,450	20
56	1 5031 027 048	51 x 56	49,0	1 5031 028 048	49 x 56	47,5	1 5031 027 048	51 x 56	49,0	3,800	10

	FLEXAgraff®-PU-AS	SPR-PVC-EDU-AS	AIRflex®-KUW-EDU
	FLEXAgraff®-PU-F		
	FLEXAgraff®-CU-AS		
	FLEXAgraff®-CU-PU		

ø		øl		øl		øl	kg 100	St.			
	mm	mm	mm	mm	mm	mm		pcs.			
10	1 5031 028 007	7 x 10	6,0					0,160	50		
14	1 5031 027 009	11 x 14	10,0	1 5031 028 009	9 x 14	8,5	1 5031 028 009	9 x 14	8,5	0,300	50
17	1 5031 028 011	13 x 17	11,5	1 5031 035 011	12 x 17	11,0	1 5031 035 011	12 x 17	11,0	0,320	50
19	1 5031 028 013	15 x 19	13,5	1 5031 035 013	14 x 19	13,0	1 5031 035 013	14 x 19	13,0	0,420	50
21	1 5031 028 016	17 x 21	15,5	1 5031 035 016	16 x 21	14,5	1 5031 035 016	15 x 21	14,5	0,520	50
27	1 5031 040 021	23 x 27	21,5	1 0601 000 021	21 x 27	19,5	1 5031 035 021	20 x 27	19,5	1,120	25
36	1 5031 028 029	29 x 36	27,5	1 5031 037 029	28 x 36	27,5	1 5031 028 029	28 x 36	27,5	1,640	25
45	1 5031 028 036	38 x 45	36,5	1 5031 035 036	37 x 45	35,5	1 5031 035 036	37 x 45	35,5	2,450	20
56	1 5031 028 048	49 x 56	47,5	1 5031 035 048	48 x 56	47,0	1 5031 035 048	48 x 56	47,0	3,800	10

	FLEXAgraff®-SI-ASF
--	--------------------

ø		øl	kg 100	St.	
	mm	mm		pcs.	
14	1 5031 037 009	10 x 14	9,0	0,160	50
17	1 5031 037 011	12 x 17	10,5	0,320	50
21	1 5031 035 016	16 x 21	14,5	0,520	50
27	1 0601 000 021	21 x 27	19,5	1,120	25
36	1 5031 037 029	27 x 36	26,5	1,640	25
45	1 5031 037 036	36 x 45	34,5	2,450	20
56	1 5031 037 048	47 x 56	45,5	3,800	10

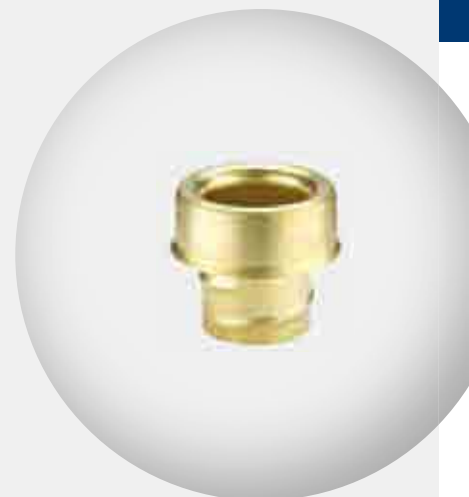
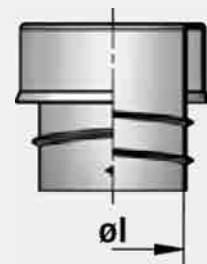

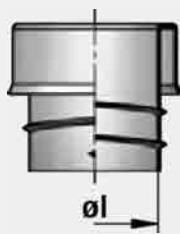

## EE

🔥 -40°C ... +250°C

Endtülle | Innentülle

Terminal sleeve | ferrule

### MATERIAL

Messing

### MATERIAL

brass

### VERWENDUNG

- als Endtülle an Schutzschläuchen

### APPLICATION

- as terminal sleeve for protective conduits

AD  
OD

FLEXA No.



## EE

LIQUID-TIGHT-EF  
LIQUID-TIGHT-EF-OR

LIQUID-TIGHT-UL-CSA

ø		mm	øl mm	kg 100	St. pcs.
5/16"	1 5031 028 009	10,0 x 14,5	8,5	0,300	50
3/8"	1 0601 000 011	12,5 x 18,0	11,0	0,300	50
1/2"	1 0601 000 016	16,0 x 21,0	14,5	0,700	50
3/4"	1 0601 000 021	21,0 x 26,5	19,5	1,000	25
1"	1 0601 000 029	26,5 x 33,0	25,0	1,500	25
1 1/4"	1 0601 000 036	35,5 x 42,0	33,0	1,900	20
2"	1 0601 000 048	50,0 x 60,0	49,0	2,800	10

\* Lieferzeit auf Anfrage Delivery time on request

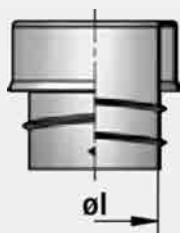

## EEK

🔥 -10°C ... +110°C

Endtülle | Innentülle

Terminal sleeve | ferrule

### MATERIAL

Kunststoff

### MATERIAL

plastics

### VERWENDUNG

- für USK-Verschraubungen
- als Endtülle an AIRflex®-Schutzschläuchen

### APPLICATION

- for connectors USK
- as terminal sleeve for protective conduits AIRflex®

AD  
OD

FLEXA No.



## EEK

AIRflex®-KUW-PVC-AS  
AIRflex®-KUW-PU-AS  
AIRflex®-GRS  
AIRflex®-K

ø		mm	øl mm	kg 100	St. pcs.
10	1 5020 030 007	7 x 10	6,0	0,040	50
14	1 5020 030 009	10 x 14	9,0	0,060	50
17	1 5020 030 011	13 x 17	11,5	0,100	50
19	1 5020 030 013	15 x 19	13,0	0,120	50
21	1 5020 030 016	16 x 21	14,5	0,140	50
27	1 5020 030 021	21 x 27	19,5	0,240	25
36	1 5020 030 029	29 x 36	26,5	0,400	25
45	1 5020 030 036	38 x 45	36,0	0,600	20
56	1 5020 030 048	48 x 56	45,5	0,770	10

## SCHLAUCHTRENNSCHERE | CONDUIT SEPARATING SHEARS

Zum Schneiden von  
Metallschlauch

For cutting of  
metal conduits

FLEXA No.	Länge length mm	St.   pcs.
1 0432 000 001	175	1



## TÜLLENEINDREHER | BELL FITTING DRIVER

Zum Einschrauben der Tüllen  
in den Schlauch

For screwing the sleeves  
into the conduit

FLEXA No.	AD OD mm	St.   pcs.
1 0410 000 007*	10 - 21	1
1 0410 000 021*	27 - 56	1



## MONTAGEZANGE | CIRCLIP PLIERS

Zur Montage des Messing-Druckrings auf  
einen umflochtenen Schlauch

For easy mounting the  
brass thrust collar on the conduit

FLEXA No.	AD OD mm	St.   pcs.
1 0420 000 007*	10	1
1 0420 000 009*	14	1
1 0420 000 011*	17	1
1 0420 000 013*	19	1
1 0420 000 016*	21	1
1 0420 000 021*	27	1
1 0420 000 029*	36	1
1 0420 000 036*	45	1
1 0420 000 048*	56	1

\* Lieferzeit auf Anfrage Delivery time on request



09

ZUBEHÖR  
ACCESSORIES



[www.flexa.de](http://www.flexa.de)

**FR-M|P|N|C**

Flach-Dichtring  
Material Perbunan  
Flat-sealing  
Material perbunan



09.2

**FRH-M|P|N|C**

Flach-Dichtring  
Material Centellen  
Flat-sealing  
Material centellen



09.3

**OR-M|P**

O-Ring  
Material Perbunan  
O-ring  
Material perbunan



09.4

**GM-M|P|N|C**

Gegenmutter  
Material Messing vernickelt  
Counter nut  
Material nickel-plated brass



09.5

**GMK-M|P|N|C**

Gegenmutter  
Material Kunststoff  
Counter nut  
Material plastics



09.6

**GMK-Duo-M**

Gegenmutter für RQG-Duo-M  
teilbar  
Material Kunststoff  
Counter nut for RQG-Duo-M  
separable  
Material plastics



09.7

**GME-M|P**

EMV-Gegenmutter  
Material Messing vernickelt  
EMC locking nut  
Material nickel-plated brass



09.7

**VBM-M**

Verbindungsmuffe  
Material Messing vernickelt  
Coupling sleeve  
Material nickel-plated brass



09.8

**WIC-M|P**

Anschlusswinkel  
Material  
Zinkdruckguss vernickelt  
Connecting elbow  
Material  
nickel-plated zinc die-casting



09.9

**REM-M|P**

Reduzierung für  
Verschraubungen  
Material Messing vernickelt  
Reducer for connectors  
Material nickel-plated brass



09.10

**REK-M|P**

Reduzierung für  
Verschraubungen  
Material Kunststoff  
Reducer for connectors  
Material plastics



09.11

**EWM-M|P**

Erweiterung  
für Verschraubungen  
Material Messing vernickelt  
Enlargement part  
for connectors  
Material nickel-plated brass



09.12

**EWK-M|P**

Erweiterung für  
Verschraubungen  
Material Kunststoff  
Enlargement part for  
connectors  
Material plastics



09.13

**ADM-MP|PM**

Adapter  
Material Messing vernickelt  
Adaptor  
Material nickel-plated brass



09.14

**ADK-MP|PM**

Adapter  
Material Polyamid  
Adaptor  
Material polyamide



09.15

**ADMf-M**

Brandschott Adapter  
Material Messing vernickelt  
Fire protection closure  
Material nickel-plated brass



09.16

**STM-M|P**

Blindstopfen mit Kragen  
Material Messing vernickelt  
Blind plug with collar  
Material nickel-plated brass

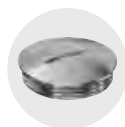

09.17

**STK-M|P**

Blindstopfen  
Material Polyamid  
Blind plug  
Material polyamide



09.18

**Z-M**

Adapter mit Zugentlastung  
Material Messing vernickelt  
Adaptor with strain relief  
Material nickel-plated brass



09.19

**KSM-M|P**

Kabelverschraubung  
Material Messing vernickelt  
Cable gland  
Material nickel-plated brass



09.20

**KSK-M|P**

Kabelverschraubung  
Material Messing vernickelt  
Cable gland  
Material nickel-plated brass



09.21

**DE-M|P**

Mehrfach Dichteinsatz für  
Kabelverschraubung  
Material TPE  
Multiple sealing insert  
for cable glands  
Material TPE

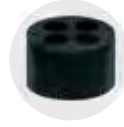

09.22

**DEO-M|P**

Dichteinsatz ohne Bohrung  
Material TPE  
Sealing insert without bore hole  
Material TPE



09.22

**BW-M|P**

Befestigungswinkel  
Material Eloc passiviert  
Fastening angle  
Material eloc-passivated



09.23

**BWK-M|P**

Befestigungswinkel  
Material Kunststoff  
Fastening angle  
Material plastics



09.24

**SKM | SKM-Multi**

Schlauch-Klemmschelle  
Material Stahl verzinkt  
Tubing-clamp  
Material galvanized steel



09.25

🌡️ -20°C ... +100°C ^ +120°C

## FR

Flachdichtring

Flat-sealing

**MATERIAL**  
Perbunan

**MATERIAL**  
perbunan

### EIGENSCHAFTEN

- beständig gegen Öl
- Abdichtung gegen Wasser und Staub

### PROPERTIES

- resistant against oil
- protection against water and dust

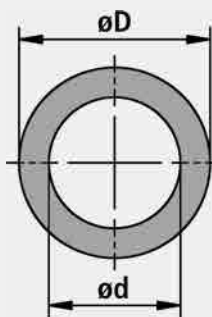

**FLEXA No.**



Perbunan

ød  
mm

øD  
mm

S  
mm

kg|100

St.  
pcs.

### FR-M

Metr.

1 0333 000 010	M 10	10,0	17,0	1,5	0,028	50
1 0333 000 012	M 12	12,0	20,0	1,5	0,038	50
1 0333 000 016	M 16	16,0	23,0	2,0	0,054	50
1 0333 000 020	M 20	20,0	29,0	2,0	0,087	50
1 0333 000 025	M 25	25,0	37,0	2,0	0,146	50
1 0333 000 032	M 32	32,0	44,0	2,0	0,179	25
1 0333 000 040	M 40	40,0	52,0	2,0	0,217	25
1 0333 000 050	M 50	50,0	64,0	2,5	0,392	25
1 0331 000 018	M 63	60,5	66,0	3,0	0,205	10

### FR-P

PG

1 0331 000 007	7	11,5	16,0	2,0	0,024	50
1 0331 000 009	9	14,0	20,0	2,0	0,040	50
1 0331 000 011	11	18,5	22,5	2,0	0,032	50
1 0331 000 013	13,5	19,0	25,0	2,0	0,052	50
1 0331 000 016	16	21,0	27,0	2,0	0,057	50
1 0331 000 021	21	27,0	34,0	2,5	0,105	25
1 0331 000 029	29	35,0	43,0	2,5	0,153	25
1 0331 000 036	36	45,0	54,0	2,5	0,219	25
1 0331 000 048	48	57,5	68,0	3,0	0,388	10

### FR-N|C

NPT  
ANSI/ASME B1.20.1

CTG  
JIS B0204

Whitworth  
DIN ISO 228-1

1 0331 000 002	1/4"		1/4"	14,0	17,0	1,5	0,026	50
1 0331 000 011	3/8"		3/8"	18,5	22,5	2,0	0,040	50
1 0331 000 016	1/2"	G16	1/2"	21,0	27,0	2,0	0,066	50
1 0331 000 021	3/4"	G22	3/4"	27,0	34,0	2,5	0,144	25
1 0331 000 045	1"	G28	1"	34,0	43,0	2,0	0,164	25
1 0331 000 008	1 1/4"	G36	1 1/4"	42,5	51,0	3,0	0,280	25
1 0331 000 014	1 1/2"		1 1/2"	48,5	55,0	3,0	0,200	25
1 0331 000 018	2"	G54	2"	60,5	66,0	3,0	0,320	10

# FRH

🔥 -50°C ... +200°C

Flachdichtring  
Speziell für Schutzart IP 68 geeignet  
bei gleichzeitig hoher mechanischer  
Beständigkeit

Flat-sealing  
Especially for protective rate IP 68  
and high mechanical stresses

## MATERIAL

Centellen

## MATERIAL

centellen

## EIGENSCHAFTEN

- beständig gegen Öl
- Abdichtung gegen Wasser und Staub
- UV-beständig
- halogenfrei
- hohe mechanische Belastbarkeit

## PROPERTIES

- resistant against oil
- protection against water and dust
- UV resistant
- free of halogen
- high mechanical stresses



FLEXA No.



Centellen

ød  
mm

øD  
mm

S  
mm

kg|100

St.  
pcs.

### FRH – M

Metr.

FLEXA No.	Metr.	ød mm	øD mm	S mm	kg 100	St. pcs.
1 0333 001 010	M 10	10,5	16,0	1,5	0,031	50
1 0333 001 012	M 12	12,5	20,0	1,5	0,052	50
1 0333 001 016	M 16	16,5	24,0	2,0	0,086	50
1 0333 001 020	M 20	20,5	29,0	2,0	0,119	50
1 0333 001 025	M 25	25,5	34,0	2,0	0,143	50
1 0333 001 032	M 32	32,5	40,0	2,0	0,154	25
1 0333 001 040	M 40	40,5	50,0	2,0	0,243	25
1 0333 001 050	M 50	50,5	60,0	3,0	0,445	25
1 0333 001 063	M 63	63,5	70,0	3,0	0,368	10

### FRH – P

PG

FLEXA No.	PG	ød mm	øD mm	S mm	kg 100	St. pcs.
1 0331 001 007	7	13,0	17,0	2,0	0,034	50
1 0331 001 009	9	15,7	20,0	2,0	0,043	50
1 0331 001 011	11	19,1	24,0	2,0	0,060	50
1 0331 001 013	13,5	20,9	26,0	2,0	0,068	50
1 0331 001 016	16	23,0	29,0	2,0	0,088	50
1 0331 001 021	21	28,8	36,0	3,0	0,198	25
1 0331 001 029	29	37,5	48,0	3,0	0,381	25
1 0331 001 036	36	47,5	54,0	3,0	0,280	25
1 0331 001 048	48	59,8	70,0	3,0	0,562	10

### FRH – N| – C

NPT  
ANSI/ASME B1.20.1

CTG  
JIS B0204

Whitworth  
DIN ISO 228-1

FLEXA No.	NPT ANSI/ASME B1.20.1	CTG JIS B0204	Whitworth DIN ISO 228-1	ød mm	øD mm	S mm	kg 100	St. pcs.
1 0331 001 002	1/4"		1/4"	13,2	20,0	2,0	0,030	50
1 0331 001 003	3/8"		3/8"	16,7	22,0	2,0	0,064	50
1 0331 001 004	1/2"	G16	1/2"	21,0	28,0	2,0	0,080	50
1 0331 001 006	3/4"	G22	3/4"	26,5	34,0	2,0	0,130	25
1 0331 001 005	1"	G28	1"	33,0	42,0	2,0	0,190	25
1 0331 001 008	1 1/4"	G36	1 1/4"	41,9	53,0	2,0	0,240	25
1 0331 001 014	1 1/2"		1 1/2"	47,8	62,0	2,0	0,250	25
1 0331 001 018	2"	G54	2"	59,6	69,0	2,0	0,260	10

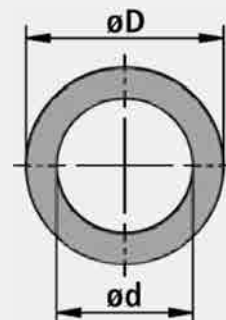

🌡️ -20°C ... +100°C ^ +120°C

# OR

O-Ring

**MATERIAL**  
Perbunan

**EIGENSCHAFTEN**

- beständig gegen Öl
- Abdichtung gegen Wasser und Staub

O-ring

**MATERIAL**  
perbunan

**PROPERTIES**

- resistant against oil
- protection against water and dust

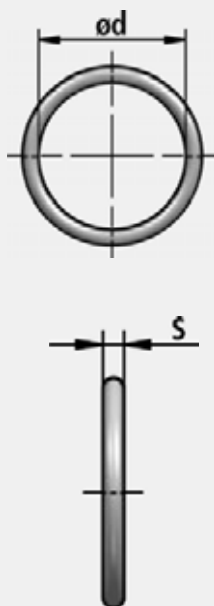

FLEXA No.



FLEXA No.		ød mm	S mm	kg 100	St. pcs.
<b>OR-M</b>					
	<b>Metr.</b>				
1 0330 001 010	M 10	8,0	1,5	0,007	50
1 0330 001 012	M 12	10,0	1,5	0,008	50
1 0330 001 016	M 16	14,0	2,0	0,020	50
1 0330 001 020	M 20	18,0	2,0	0,025	50
1 0330 001 025	M 25	23,0	2,0	0,031	50
1 0330 001 032	M 32	30,0	2,0	0,039	25
1 0330 001 040	M 40	38,0	2,5	0,078	25
1 0330 001 050	M 50	48,0	2,5	0,097	25
1 0330 001 063	M 63	61,0	3,0	0,178	10
<b>OR-P</b>					
	<b>PG</b>				
1 0330 000 007	7	10,0	1,5	0,008	50
1 0330 000 009	9	12,5	1,8	0,014	50
1 0330 000 011	11	16,0	2,0	0,022	50
1 0330 000 013	13,5	18,0	2,0	0,025	50
1 0330 000 016	16	20,0	2,0	0,027	50
1 0330 000 021	21	26,0	2,0	0,035	25
1 0330 000 029	29	34,0	2,0	0,044	25
1 0330 000 036	36	44,0	2,5	0,090	25
1 0330 000 048	48	53,0	2,5	0,107	10



## GM

Gegenmutter

Counternut

## MATERIAL

Messing, vernickelt

## MATERIAL

nickel-plated brass

## VERWENDUNG

Gegenmutter speziell für Metallgewinde

## APPLICATION

Counternut especially for metal threads

-40°C ... +200°C



FLEXA No

SW  
mmS  
mm

kg|100

St.  
pcs.

## GM-M

Metr  
EN 60423

FLEXA No	Metr	SW mm	S mm	kg 100	St. pcs.
1 0531 000 010	M 10 x 1,0	14	2,8	0,110	100
1 0531 000 012	M 12 x 1,5	15	2,8	0,220	100
1 0531 000 016	M 16 x 1,5	19	2,8	0,300	100
1 0531 000 020	M 20 x 1,5	24	3,0	0,510	100
1 0531 000 025	M 25 x 1,5	30	3,5	0,910	100
1 0531 000 032	M 32 x 1,5	36	4,0	1,080	100
1 0531 000 040	M 40 x 1,5	46	5,0	2,420	50
1 0531 000 050	M 50 x 1,5	60	5,0	4,820	50
1 0531 000 063	M 63 x 1,5	70	6,0	5,560	50

## GM-P

PG  
DIN 40430

FLEXA No	PG	SW mm	S mm	kg 100	St. pcs.
1 0530 000 007	7	15	2,8	0,190	100
1 0530 000 009	9	18	2,8	0,270	100
1 0530 000 011	11	21	3,0	0,310	100
1 0530 000 013	13,5	23	3,0	0,350	100
1 0530 000 016	16	26	3,0	0,500	100
1 0530 000 021	21	32	3,5	0,770	100
1 0530 000 029	29	41	4,0	1,290	100
1 0530 000 036	36	51	5,0	2,180	50
1 0530 000 048	48	64	5,5	3,440	25

## GM-N|-C

NPT  
ANSI/ASME B1 20 1

FLEXA No	NPT	SW mm	S mm	kg 100	St. pcs.
1 0531 000 002	3/8"	20	3,0	0,360	100
1 0531 000 003	1/2"	24	3,0	0,430	100
1 0531 000 004	3/4"	30	3,5	0,740	100
1 0531 000 005	1"	38	4,0	1,540	100
1 0531 000 006	1 1/4"	46	5,0	1,950	100
1 0531 000 007	1 1/2"	51	5,0	2,060	100
1 0531 000 008	2"	64	5,5	3,450	50

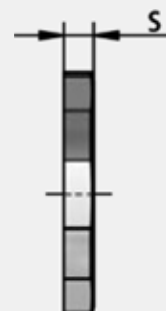
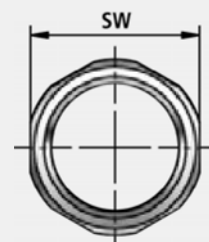

🌡️ -40°C ... +100°C

# GMK

Gegenmutter

## MATERIAL

Polyamid, glasfaserverstärkt

## EIGENSCHAFTEN

- beständig gegen schwache Säuren und Laugen
- beständig gegen Meerwasser, Benzin und Mineralöl

Counternut

## MATERIAL

polyamide, fibre-glass reinforced

## PROPERTIES

- resistant against light acids and soft lyes
- resistant against sea water, benzine and mineral oil

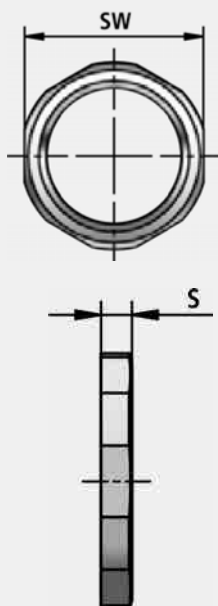

FLEXA No.

FLEXA No.



schwarz  
black

grau  
grey

SW  
mm

S  
mm

kg|100

St.  
pcs.

### GMK – M

Metr.  
EN 60423

FLEXA No.	FLEXA No.	Metr.	SW	S	kg 100	St.
1 0309 000 210		M 10 x 1,0	14	3,0	0,040	100
1 0309 000 212	1 0309 000 012	M 12 x 1,5	17	5,0	0,100	100
1 0309 000 216	1 0309 000 016	M 16 x 1,5	22	5,0	0,150	100
1 0309 000 220	1 0309 000 020	M 20 x 1,5	26	6,0	0,230	100
1 0309 000 225	1 0309 000 025	M 25 x 1,5	32	6,0	0,260	100
1 0309 000 232	1 0309 000 032	M 32 x 1,5	41	7,0	0,380	100
1 0309 000 240	1 0309 000 040	M 40 x 1,5	50	7,0	0,660	50
1 0309 000 250	1 0309 000 050	M 50 x 1,5	60	8,0	1,080	25
1 0309 000 263	1 0309 000 063	M 63 x 1,5	75	8,0	1,900	10

### GMK – P

PG  
DIN 40430

FLEXA No.	FLEXA No.	Metr.	SW	S	kg 100	St.
1 0310 000 207	1 0310 000 007	7	19	5,0	0,130	100
1 0310 000 209	1 0310 000 009	9	22	5,0	0,160	100
1 0310 000 211	1 0310 000 011	11	24	5,0	0,160	100
1 0310000 213	1 0310 000 013	13,5	27	6,0	0,250	100
1 0310 000 216	1 0310 000 016	16	30	6,0	0,310	100
1 0310 000 221	1 0310 000 021	21	36	7,0	0,430	100
1 0310 000 229	1 0310 000 029	29	46	7,0	0,660	100
1 0310 000 236	1 0310 000 036	36	60	8,0	1,240	50
1 0310 000 248	1 0310 000 048	48	70	8,0	1,560	25

### GMK – N| – C

NPT  
ANSI/ASME B1.20.1

FLEXA No.	FLEXA No.	Metr.	SW	S	kg 100	St.
1 0316 000 202	1 0316 000 002	3/8"	22	5,0	0,180	100
1 0316 000 203	1 0316 000 003	1/2"	27	6,0	0,250	100
1 0316 000 204	1 0316 000 004	3/4"	36	7,0	0,550	100
1 0316 000 205	1 0316 000 005	1"	42	7,0	0,680	100

# GMK–Duo | GME

Gegenmutter, teilbar  
für RQG–Duo–M

Counternut, separable  
for RQG–Duo–M

## MATERIAL

Kunststoff [PA 6 mod.]

## MATERIAL

plastics [PA 6 mod.]

## EIGENSCHAFTEN

- speziell für den Einsatz bei geteilten Kabelschutzsystemen
- einfache Montage | Demontage

## PROPERTIES

- specifically for use in dividable cable protection systems
- simple assembly | disassembly

🔥 -40°C ... +110°C ^ +150°C

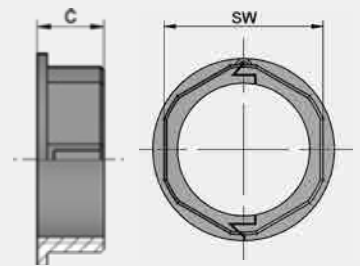

### FLEXA No



schwarz  
black

C  
mm

SW  
mm

kg|100

St.  
pcs.

### GMK–Duo

Metr  
EN 60423

	Metr EN 60423	C mm	SW mm	kg 100	St. pcs.
1 0318 000 016	M 16 x 1,5	10	26	0,160	10
1 0318 000 020	M 20 x 1,5	10	26	0,180	10
1 0318 000 025	M 25 x 1,5	10	28	0,200	10
1 0318 000 032	M 32 x 1,5	10	36	0,400	5
1 0318 000 040	M 40 x 1,5	12	46	0,900	5
1 0318 000 050	M 50 x 1,5	12	56	1,200	5
1 0318 000 063	M 63 x 1,5	12	71	1,850	5

Gegenmutter EMV  
mit Schneidkante, um eine erhöhte  
elektrische Leitfähigkeit zu erreichen

Counternut EMC  
Counternut with cutting edges  
for best contact

## MATERIAL

Messing vernickelt

## MATERIAL

nickel-plated brass

🔥 -40°C ... +200°C

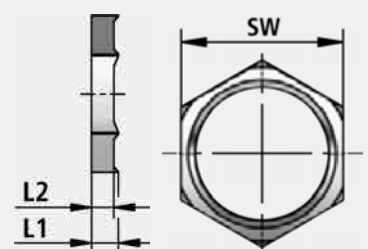

### FLEXA No



L1  
mm

L2  
mm

SW  
mm

kg|100

St.  
pcs.

### GME–M

Metr  
EN 60423

	Metr EN 60423	L1 mm	L2 mm	SW mm	kg 100	St. pcs.
1 0561 000 012	M 12 x 1,5	5,5	4,5	15	0,360	100
1 0561 000 016	M 16 x 1,5	5,5	4,5	19	0,500	100
1 0561 000 020	M 20 x 1,5	5,5	4,5	24	0,770	100
1 0561 000 025	M 25 x 1,5	5,5	4,5	30	1,180	100
1 0561 000 032	M 32 x 1,5	5,5	4,5	36	1,300	100
1 0561 000 040	M 40 x 1,5	6,0	5,0	46	2,640	50
1 0561 000 050	M 50 x 1,5	6,0	5,0	60	5,020	50
1 0561 000 063	M 63 x 1,5	7,0	6,0	70	6,000	50

### GME–P

PG  
DIN 40430

	PG DIN 40430	L1 mm	L2 mm	SW mm	kg 100	St. pcs.
1 0560 000 007	7	4,7	3,7	15	0,250	100
1 0560 000 009	9	4,7	3,7	18	0,360	100
1 0560 000 011	11	4,7	3,7	21	0,420	100
1 0560 000 013	13,5	4,7	3,7	23	0,460	100
1 0560 000 016	16	4,7	3,7	26	0,640	100
1 0560 000 021	21	5,2	4,2	32	1,000	100
1 0560 000 029	29	5,7	4,7	41	1,640	100
1 0560 000 036	36	6,0	5,0	51	2,340	50
1 0560 000 048	48	6,5	5,5	64	3,900	50

 -40°C ... +200°C

## VBM

Verbindungsuffe  
Verbindung metrisch zu metrisch

Fitting sleeve  
Connection metric to metric thread

**MATERIAL**  
Messing vernickelt

**MATERIAL**  
nickel-plated brass

**EIGENSCHAFTEN**  
• hohe Stabilität

**PROPERTIES**  
• high stability

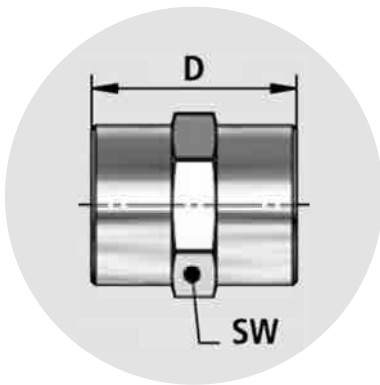

FLEXA No.



Innen  
inner



Innen  
inner

D  
mm



SW  
mm



kg/100



St.  
pcs.

**VBM-M**

**Metr.**  
EN 60423

**Metr.**  
EN 60423

	<b>Metr.</b> EN 60423	<b>Metr.</b> EN 60423	D mm	SW mm	kg/100	St. pcs.
1 0527 001 016	M 16 x 1,5	M 16 x 1,5	18,0	19	1,950	20
1 0527 001 020	M 20 x 1,5	M 20 x 1,5	22,0	22	3,300	20
1 0527 001 025	M 25 x 1,5	M 25 x 1,5	24,0	28	5,500	10
1 0527 001 032	M 32 x 1,5	M 32 x 1,5	30,0	35	7,700	10
1 0527 001 040	M 40 x 1,5	M 40 x 1,5	37,0	45	12,200	5
1 0527 001 050	M 50 x 1,5	M 50 x 1,5	37,0	52	6,800	5

# WIC

Anschlusswinkel  
Innen- und Außengewinde  
inkl. O-Ring

Connecting Elbow  
Inner and outer thread  
O-ring incl.

🔥 -40°C ... +100°C WIC-M  
🔥 -20°C ... +100°C WIC-P

## MATERIAL

WIC-P Zinkdruckguss  
WIC-M Messing vernickelt  
O-Ring NBR

## MATERIAL

WIC-P zinc die-casting  
WIC-M nickel-plated brass  
O-ring NBR





## EIGENSCHAFTEN

- hohe Stabilität
- niedrige Bauhöhe

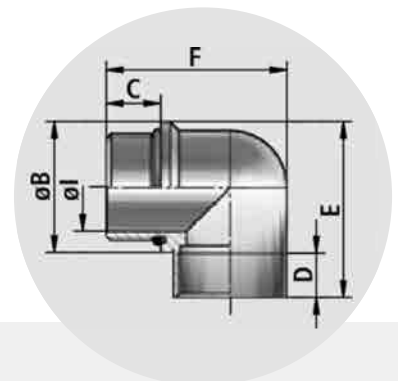
## PROPERTIES

- high stability
- low overall height



FLEXA No.					øI mm	øB mm	C mm	D mm	E mm	F mm	 kg/100	 St. pcs.
	Innen inner	Außen outer	Metr. EN 60423	Metr. EN 60423								
<b>WIC-M</b>												
1 0512 300 012	M 12 x 1,5	M 12 x 1,5	8,0	15,0	5,0	8,0	24,5	25,0	2,100	50		
1 0512 300 016	M 16 x 1,5	M 16 x 1,5	12,0	19,0	5,0	8,0	29,0	30,0	3,240	50		
1 0512 300 020	M 20 x 1,5	M 20 x 1,5	16,0	24,0	6,0	10,0	36,5	36,0	6,100	50		
1 0512 300 025	M 25 x 1,5	M 25 x 1,5	21,0	29,0	7,5	12,0	42,5	44,0	8,960	25		
1 0512 300 032	M 32 x 1,5	M 32 x 1,5	26,0	36,0	8,5	11,5	50,0	52,0	13,840	25		
1 0512 300 040	M 40 x 1,5	M 40 x 1,5	35,0	46,0	10,0	18,0	70,0	66,5	31,800	10		
1 0512 300 050	M 50 x 1,5	M 50 x 1,5	45,0	56,0	9,0	18,0	76,5	77,5	44,700	10		
<b>WIC-P</b>												
	<b>PG</b> DIN 40430	<b>PG</b> DIN 40430										
1 0512 100 009	9	9	11,5	19,5	11,0	9,0	28,0	30,0	2,280	50		
1 0512 100 011	11	11	14,3	23,5	11,0	9,5	32,0	33,0	3,200	50		
1 0512 100 013	13,5	13,5	16,0	25,5	11,6	10,0	34,0	36,0	4,020	50		
1 0512 100 016	16	16	18,5	27,5	11,5	11,0	38,5	38,0	8,520	50		
1 0512 100 021	21	21	23,8	34,0	13,0	13,0	45,0	46,0	7,360	25		
1 0512 100 029	29	29	32,0	44,0	15,0	14,5	55,0	59,0	26,160	25		

🌡️ -40°C ... +200°C

# REM

Reduzierung  
inkl. O-Ring  
Zur Reduzierung eines metrischen oder  
PG Gewindes in eine kleinere Abmessung

Reducer  
O-ring incl.  
For reduction of a metric or PG thread  
to a smaller size

## MATERIAL

Reduzierung Messing vernickelt  
O-Ring NBR

## MATERIAL

Reducer nickel-plated brass  
O-ring NBR

## EIGENSCHAFTEN

- hohe Stabilität

## PROPERTIES

- high stability



### FLEXA No.



Außen  
outer



Innen  
inner



kg|100



St.  
pcs.

### REM – M

	Metr. EN 60423	Metr. EN 60423	SW mm	L1 mm	L mm	kg 100	St. pcs.
1 0350 M16 M12	M 16 x 1,5	M 12 x 1,5	17	5,0	8,0	0,750	100
1 0350 M20 M12	M 20 x 1,5	M 12 x 1,5	22	6,0	9,0	1,590	100
1 0350 M20 M16	M 20 x 1,5	M 16 x 1,5	22	6,0	9,0	0,950	100
1 0350 M25 M16	M 25 x 1,5	M 16 x 1,5	27	7,0	10,0	2,640	100
1 0350 M25 M20	M 25 x 1,5	M 20 x 1,5	27	7,0	10,0	1,740	100
1 0350 M32 M16*	M 32 x 1,5	M 16 x 1,5	34	8,0	11,0	5,660	50
1 0350 M32 M20	M 32 x 1,5	M 20 x 1,5	34	8,0	11,0	4,400	50
1 0350 M32 M25	M 32 x 1,5	M 25 x 1,5	34	8,0	11,0	3,700	50
1 0350 M40 M20*	M 40 x 1,5	M 20 x 1,5	43	8,0	12,0	10,000	25
1 0350 M40 M25	M 40 x 1,5	M 25 x 1,5	43	8,0	12,0	5,080	25
1 0350 M40 M32	M 40 x 1,5	M 32 x 1,5	43	8,0	12,0	6,360	25
1 0350 M50 M25	M 50 x 1,5	M 25 x 1,5	55	9,0	13,0	19,950	10
1 0350 M50 M32*	M 50 x 1,5	M 32 x 1,5	55	9,0	13,0	14,900	10
1 0350 M50 M40	M 50 x 1,5	M 40 x 1,5	55	9,0	13,0	9,600	10
1 0350 M63 M32*	M 63 x 1,5	M 32 x 1,5	65	10,0	14,0	27,850	10
1 0350 M63 M40*	M 63 x 1,5	M 40 x 1,5	65	10,0	14,0	22,900	10
1 0350 M63 M50	M 63 x 1,5	M 50 x 1,5	65	10,0	14,0	17,900	10

### REM – P

	PG DIN 40430	PG DIN 40430	SW mm	L1 mm	L mm	kg 100	St. pcs.
1 0350 P09 P07	9	7	18	6,0	8,5	0,460	100
1 0350 P11 P07	11	7	20	6,0	8,5	1,050	100
1 0350 P11 P09	11	9	20	6,0	8,5	0,650	100
1 0350 P13 P07	13,5	7	24	6,5	9,5	1,500	100
1 0350 P13 P09	13,5	9	24	6,5	9,5	1,090	100
1 0350 P13 P11	13,5	11	24	6,5	9,5	0,490	100
1 0350 P16 P09*	16	9	24	6,5	9,5	1,710	100
1 0350 P16 P11*	16	11	24	6,5	9,5	1,010	100
1 0350 P16 P13	16	13,5	24	6,5	9,5	0,610	100
1 0350 P21 P16	21	16	32	7,0	10,0	1,910	100
1 0350 P29 P16*	29	16	41	8,0	11,5	6,500	50
1 0350 P29 P21	29	21	41	8,0	11,5	4,440	50
1 0350 P36 P21*	36	21	50	9,0	12,5	11,920	25
1 0350 P36 P29	36	29	50	9,0	12,5	7,400	25

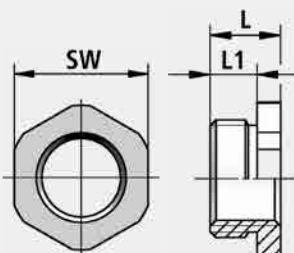

\* Lieferzeit auf Anfrage Delivery time on request

# REK

🔥 -30°C ... +100°C

Reduzierung  
Zur Reduzierung eines metrischen oder  
PG Gewindes in eine kleinere Abmessung

Reducer  
For reduction of a metric or PG thread  
to a smaller size

## MATERIAL

Polyamid, glasfaserverstärkt

## MATERIAL

polyamide, fibre-glass reinforced



## EIGENSCHAFTEN

- beständig gegen schwache Säuren und Laugen
- beständig gegen Meerwasser, Benzin und Mineralöl

## PROPERTIES

- resistant against light acids and soft lyes
- resistant against sea water, benzine and mineral oil



FLEXA No.	FLEXA No.	Type				L1	L	kg 100	St.
schwarz RAL 9005 black	grau RAL 7035 grey		Außen outer	Innen inner	SW mm	mm	mm		pcs.

### REK – M

		Type	Metr. EN 60423	Metr. EN 60423	SW	L1	L	kg 100	St.
1 0352 M20 M12*	1 0351 M20 M12*	A	M 20 x 1,5	M 12 x 1,5	24	8,0	12,0	0,400	100
1 0352 M20 M16*	1 0351 M20 M16*	A	M 20 x 1,5	M 16 x 1,5	24	8,0	12,0	0,260	100
1 0352 M25 M16*	1 0351 M25 M16*	A	M 25 x 1,5	M 16 x 1,5	29	8,0	14,0	0,500	100
1 0352 M25 M20*	1 0351 M25 M20*	A	M 25 x 1,5	M 20 x 1,5	29	8,0	14,0	0,480	100
1 0352 M32 M20*	1 0351 M32 M20*	A	M 32 x 1,5	M 20 x 1,5	36	10,0	16,0	0,600	50
1 0352 M32 M25*	1 0351 M32 M25*	A	M 32 x 1,5	M 25 x 1,5	36	10,0	16,0	0,800	50
1 0352 M40 M32*	1 0351 M40 M32*	A	M 40 x 1,5	M 32 x 1,5	55	10,0	16,0	1,260	50
1 0352 M50 M40*	1 0351 M50 M40*	A	M 50 x 1,5	M 40 x 1,5	55	12,0	18,0	1,920	25
1 0352 M63 M40*	1 0351 M63 M40*	A	M 63 x 1,5	M 40 x 1,5	68	12,0	18,0	2,500	25
1 0352 M63 M50*		A	M 63 x 1,5	M 50 x 1,5	68	12,0	18,0	2,500	25

### REK – P

		Type	PG DIN 40430	PG DIN 40430	SW	L1	L	kg 100	St.
1 0352 P09 P07	1 0351 P09 P07	B	9	7	19	8,0	20,5	0,400	100
1 0352 P11 P09	1 0351 P11 P09	B	11	9	22	8,0	22,5	0,581	100
1 0352 P13 P07*	1 0351 P13 P07*	A	13,5	7	24	9,0	15,0	0,500	100
1 0352 P13 P09*	1 0351 P13 P09*	A	13,5	9	24	9,0	15,0	0,430	100
1 0352 P13 P11	1 0351 P13 P11	B	13,5	11	24	9,0	24,0	0,610	100
1 0352 P16 P09*	1 0351 P16 P09*	A	16	9	27	10,0	16,0	0,620	100
1 0352 P16 P11	1 0351 P16 P11	A	16	11	27	10,0	16,0	0,480	100
1 0352 P16 P13	1 0351 P16 P13	B	16	13,5	27	10,0	27,0	0,860	100
1 0352 P21 P11*	1 0351 P21 P11*	A	21	11	32	11,0	16,0	0,360	100
1 0352 P21 P13*	1 0351 P21 P13*	A	21	13,5	32	11,0	16,0	0,790	100
1 0352 P21 P16	1 0351 P21 P16	A	21	16	32	11,0	16,0	0,650	100
1 0352 P29 P16*	1 0351 P29 P16*	A	29	16	40	11,0	17,0	1,440	50
1 0352 P29 P21	1 0351 P29 P21	A	29	21	40	11,0	17,0	1,160	50

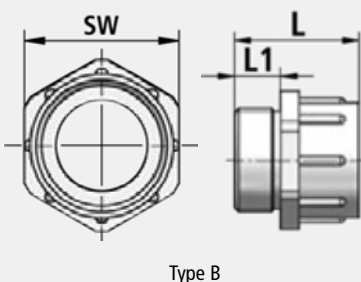
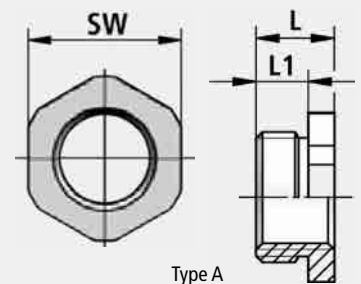

\* Lieferzeit auf Anfrage Delivery time on request

 -40°C ... +200°C

## EWM

Erweiterung  
inkl. O-Ring  
Erweiterung eines metrischen oder  
PG Gewindes in eine größere Abmessung

Enlargement  
O-ring incl.  
Extension of a metric or PG thread  
into a larger size

### MATERIAL

Erweiterung Messing vernickelt  
O-Ring NBR

### MATERIAL

Enlargement nickel-plated brass  
O-ring NBR

### EIGENSCHAFTEN

- hohe Stabilität

### PROPERTIES

- high stability



### FLEXA No.



Type

Außen  
outer

Innen  
inner

SW  
mm

L1  
mm

L  
mm

kg|100

St.  
pcs.

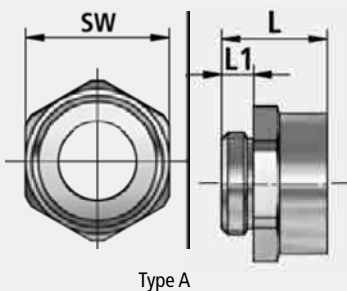

Type A

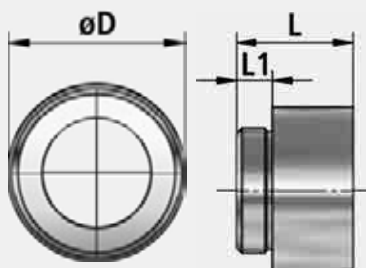

Type B

### EWM – M

	Type	Metr. EN 60423	Metr. EN 60423	SW mm	L1 mm	L mm	kg 100	St. pcs.
1 0360 M12 M16*	A	M 12 x 1,5	M 16 x 1,5	18	5,0	16,0	1,070	100
1 0360 M16 M20*	A	M 16 x 1,5	M 20 x 1,5	22	5,0	16,5	1,440	100
1 0360 M20 M25*	A	M 20 x 1,5	M 25 x 1,5	27	6,0	18,5	2,050	100
1 0360 M25 M32*	A	M 25 x 1,5	M 32 x 1,5	34	7,0	20,5	2,800	25
1 0360 M32 M40*	A	M 32 x 1,5	M 40 x 1,5	42	8,0	23,5	5,360	25
1 0360 M40 M50*	A	M 40 X 1,5	M 50 X 1,5	52	8,0	30,0	9,980	10
1 0360 M50 M63*	A	M 50 X 1,5	M 63 X 1,5	65	9,0	32,5	15,200	10

### EWM – P

	Type	PG DIN 40430	PG DIN 40430	øD mm	L1 mm	L mm	kg 100	St. pcs.
1 0360 P07 P09	B	7	9	17	5,0	15,0	0,710	100
1 0360 P09 P11	B	9	11	20	6,0	16,5	0,880	100
1 0360 P09 P13	B	9	13,5	22	6,0	17,5	1,140	100
1 0360 P11 P13*	B	11	13,5	22	6,0	17,5	1,140	100
1 0360 P11 P16*	B	11	16	24	6,5	19,0	1,300	100
1 0360 P13 P16*	B	13,5	16	24	6,5	19,0	1,400	100
1 0360 P13 P21*	B	13,5	21	30	6,5	21,0	1,550	100
1 0360 P16 P21	B	16	21	30	6,5	21,0	2,330	100
1 0360 P16 P29*	B	16	29	39	6,5	22,5	3,500	50
1 0360 P21 P29	B	21	29	39	7,0	23,0	3,620	50
1 0360 P29 P36	B	29	36	50	8,0	27,5	7,640	25

\* Lieferzeit auf Anfrage Delivery time on request



# EWK

🔥 -30°C ... +100°C

Erweiterung  
Erweiterung eines metrischen oder  
PG Gewindes in eine größere Abmessung

Enlargement  
Extension of a metric or PG thread  
into a larger size

## MATERIAL

Polyamid, glasfaserverstärkt

## MATERIAL

polyamide, fibre-glass reinforced





## EIGENSCHAFTEN

- beständig gegen schwache Säuren und Laugen
- beständig gegen Meerwasser, Benzin, Mineralöl

## PROPERTIES

- resistant against light acids and soft lyes
- resistant against sea water, benzine and mineral oil



FLEXA No	FLEXA No				L1	L		
schwarz black	grau grey	Außen outer	Innen inner	SW mm	mm	mm	kg 100	St . pcs.
<b>EWK – M</b>		<b>Metr</b> EN 60423	<b>Metr</b> EN 60423					
1 0362 M16 M20	1 0361 M16 M20*	M 16 x 1,5	M 20 x 1,5	24	8,0	20,5	0,400	100
1 0362 M20 M25	1 0361 M20 M25*	M 20 x 1,5	M 25 x 1,5	30	8,0	21,0	1,100	100
1 0362 M25 M32	1 0361 M25 M32*	M 25 x 1,5	M 32 x 1,5	37	8,0	23,0	1,000	50
1 0362 M32 M40	1 0361 M32 M40*	M 32 x 1,5	M 40 x 1,5	45	10,0	25,0	1,320	50
1 0362 M40 M50	1 0361 M40 M50*	M 40 X 1,5	M 50 X 1,5	55	8,0	27,5	2,340	50
<b>EWK – P</b>		<b>PG</b> DIN 40430	<b>PG</b> DIN 40430					
1 0362 P07 P09*	1 0361 P07 P09	7	9	19	7,0	20,0	0,300	100
1 0362 P09 P11*	1 0361 P09 P11	9	11	22	8,0	23,0	0,420	100
	1 0361 P11 P13	11	13,5	24	8,0	23,0	0,450	100
1 0362 P11 P16*	1 0361 P11 P16	11	16	27	8,0	24,5	0,710	100
1 0362 P13 P16*	1 0361 P13 P16	13,5	16	27	9,0	26,0	0,670	100
1 0362 P16 P21*	1 0361 P16 P21	16	21	32	9,0	29,0	1,040	50
1 0362 P21 P29*	1 0361 P21 P29	21	29	42	10,0	32,0	1,560	50
1 0362 P29 P36*	1 0361 P29 P36	29	36	53	11,0	35,5	2,680	25

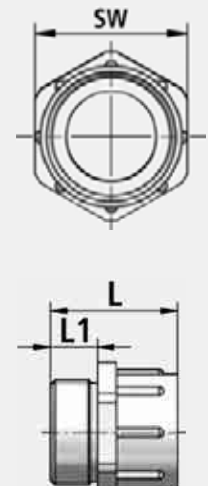

\* Lieferzeit auf Anfrage Delivery time on request

🔥 -40°C ... +200°C

# ADM

Adapter  
inkl. O-Ring  
Gewindeadapter zum Kombinieren  
verschiedener Gewindetypen  
metrisch oder PG

Adaptor  
O-ring incl.  
Thread adapter to combine  
different types of threads  
metric or PG

## MATERIAL

Adapter Messing vernickelt  
O-Ring NBR

## MATERIAL

Adaptor nickel-plated brass  
O-ring NBR

## EIGENSCHAFTEN

- hohe Stabilität
- inkl. O-Ring

## PROPERTIES

- high stability
- incl. O-ring

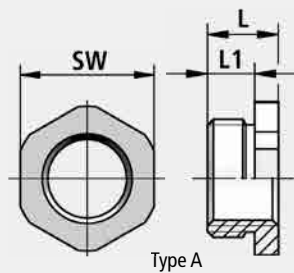
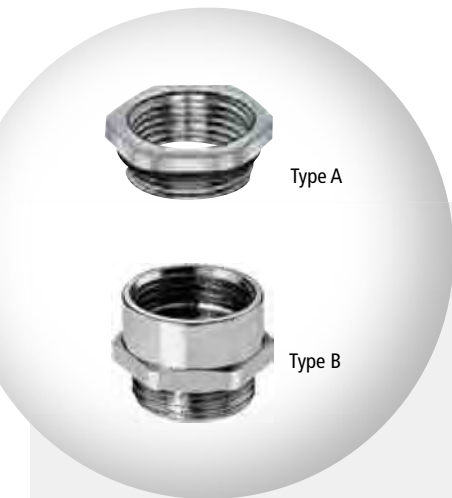

Type A

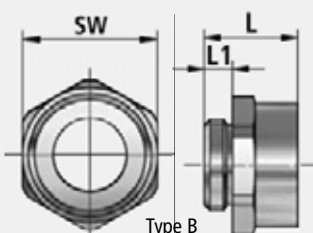

Type B

### FLEXA No.

	Type	Außen outer	Innen inner	SW mm	L1 mm	L mm	kg 100	St. pcs.
<b>ADM – MP</b>		<b>Metr.</b> EN 60423	<b>PG</b> DIN 40430					
1 0370 M12 P09*	B	M 12 x 1,5	9	17	6,0	16,5	0,940	100
1 0370 M16 P07*	A	M 16 x 1,5	7	17	5,0	8,0	0,530	100
1 0370 M16 P11*	B	M 16 x 1,5	11	20	6,0	17,0	0,990	100
1 0370 M20 P09*	A	M 20 x 1,5	9	22	6,0	9,0	1,090	100
1 0370 M20 P11*	B	M 20 x 1,5	11	22	6,5	17,5	1,740	100
1 0370 M20 P13*	B	M 20 x 1,5	13,5	22	6,5	19,0	1,440	100
1 0370 M25 P11*	A	M 25 x 1,5	11	27	7,0	10,0	1,900	100
1 0370 M25 P13*	A	M 25 x 1,5	13,5	27	7,0	10,0	1,500	100
1 0370 M25 P16*	A	M 25 x 1,5	16	27	7,0	18,0	2,500	100
1 0370 M25 P21*	B	M 25 x 1,5	21	30	7,0	20,5	2,200	50
1 0370 M32 P16*	A	M 32 x 1,5	16	34	8,0	11,0	3,810	50
1 0370 M32 P21	A	M 32 x 1,5	21	34	8,0	11,0	1,820	50
1 0370 M32 P29*	B	M 32 x 1,5	29	40	8,0	25,0	4,660	50
1 0370 M40 P21	A	M 40 x 1,5	21	43	8,0	12,0	7,080	25
1 0370 M40 P29*	A	M 40 x 1,5	29	43	8,0	12,0	2,830	25
1 0370 M50 P29*	A	M 50 x 1,5	29	55	9,0	13,0	8,000	10
1 0370 M50 P36*	A	M 50 x 1,5	36	55	9,0	13,0	3,900	10
1 0370 M63 P36*	A	M 63 x 1,5	36	65	10,0	14,0	18,740	10
1 0370 M63 P48*	B	M 63 x 1,5	48	65	10,0	33,0	19,890	5
<b>ADM – PM</b>		<b>PG</b> DIN 40430	<b>Metr.</b> EN 60423					
1 0370 P07 M12*	B	7	M 12 x 1,5	14	5,0	15,0	0,670	100
1 0370 P09 M16*	B	9	M 16 x 1,5	19	6,0	16,0	1,240	100
1 0370 P11 M16*	B	11	M 16 x 1,5	22	6,0	16,0	2,250	100
1 0370 P13 M20*	B	13,5	M 20 x 1,5	24	6,5	17,5	2,100	100
1 0370 P16 M20*	B	16	M 20 x 1,5	27	6,5	17,5	3,100	100
1 0370 P16 M25*	B	16	M 25 x 1,5	30	6,5	18,5	2,800	100
1 0370 P21 M25*	B	21	M 25 x 1,5	32	7,0	19,0	4,440	100
1 0370 P21 M32*	B	21	M 32 x 1,5	36	7,0	20,0	4,400	100
1 0370 P29 M40*	B	29	M 40 X 1,5	43	8,0	21,0	6,550	50
1 0370 P36 M50*	B	36	M 50 x 1,5	55	9,0	23,0	9,200	25

\* Lieferzeit auf Anfrage Delivery time on request

# ADK

🌡️ -30°C ... +100°C

Adapter  
Gewindeadapter zum Kombinieren  
verschiedener Gewindetypen  
metrisch oder PG

Adaptor  
Thread adapter to combine  
different types of threads  
metric or PG

## MATERIAL

Polyamid, glasfaserverstärkt

## MATERIAL

polyamide, fibre-glass reinforced





## EIGENSCHAFTEN

- beständig gegen schwache Säuren und Laugen
- beständig gegen Meerwasser, Benzin und Mineralöl

## PROPERTIES

- resistant against light acids and soft lyes
- resistant against sea water, benzine and mineral oil



FLEXA No.	Type							
grau RAL 7035 grey		Außen outer	Innen inner	SW mm	L1 mm	L mm	kg 100	St. pcs.
<b>ADK – MP</b>		<b>Metr.</b> EN 60423	<b>PG</b> DIN 40430					
1 0371 M20 P11*	A	M 20 x 1,5	11	22	11,0	26,5	0,540	100
1 0371 M20 P13	A	M 20 x 1,5	13,5	24	11,0	26,0	0,490	100
1 0371 M25 P16	A	M 25 x 1,5	16	27	11,0	28,0	0,900	50
1 0371 M25 P21*	A	M 25 x 1,5	21	32	11,0	31,0	0,900	50
1 0371 M40 P29*	A	M 40 x 1,5	29	42	11,0	34,0	2,000	10
<b>ADK – PM</b>		<b>PG</b> DIN 40430	<b>Metr.</b> EN 60423					
1 0371 P07 M12*	B	7	M 12 x 1,5	15	8,0	20,0	0,210	100
1 0371 P09 M16*	B	9	M 16 x 1,5	20	8,0	20,0	0,310	100
1 0371 P11 M20*	B	11	M 20 x 1,5	24	8,0	20,0	0,400	100
1 0371 P13 M20*	B	13,5	M 20 x 1,5	24	9,0	21,0	0,430	100
1 0371 P16 M25*	B	16	M 25 x 1,5	30	10,0	22,5	0,680	50
1 0371 P21 M32*	B	21	M 32 x 1,5	37	11,0	25,5	1,060	50

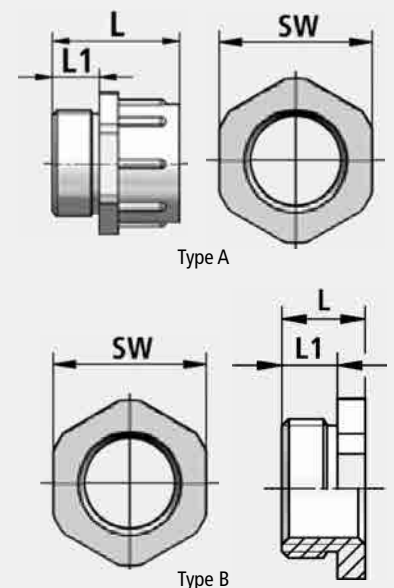

\* Lieferzeit auf Anfrage Delivery time on request

🔥 -40°C ... +600°C ^ +850°C

UL 1696 | CSA 22.2  
UR file E86359

ASTM E162|E662  
SMP 800-C



# ADMF-M

Brandschott Adapter

Fire protection closure

## KONSTRUKTION

Brandschott Adapter für durchgeführte Kabel, Brandabschottungs-Element mit intumeszierendem Material (Auslösung ab 150°C), Adapter mit Innen- | Außengewinde gleicher Gewindegröße gemäß EN 60423.

## STRUCTURE

fire barrier for fed-through cables, fire blocking element with intumescent material (thermal expansion from 150°C), adapter with same inner | outer thread size according to EN 60423.

## MATERIAL

Gehäuse      Messing, vernickelt  
                  Stahl verzinkt auf Anfrage  
  
O-Ring        Perbunan  
Einleger     kohlenstoffbasiert

## MATERIAL

Body         nickel-plated brass  
                  galvanized steel on request  
  
O-ring        Perbunan  
Inlay         carbon based

## EIGENSCHAFTEN

- mindestens 30 Minuten Feuerschutz (E30)
- horizontale und vertikale Einbaulage
- Brandschott in Kombination mit einer Verschraubung oder Kabelverschraubung
- REACH und RoHS konform

## PROPERTIES

- minimum of 30 minutes fire blocking (E30)
- horizontal and vertical fitting position
- fire barrier in combination with connectors
- REACH and RoHS compliant

## ANWENDUNGSGEBIETE

- Schienenfahrzeuge gemäß EN 45545-3: E30
- Elektroinstallationen im Maschinen- und Anlagenbau nach DIN EN 60204

## APPLICATION

- Railway industry acc. to EN 45545-3: E30
- Electrical installations for application rules machine and plant constructions acc. to DIN EN 60204

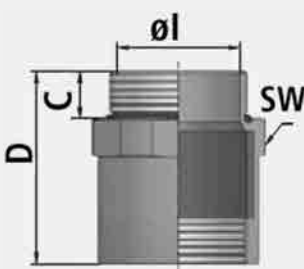

FLEXA No.



## ADMF-M

	Metr. EN 60423	øl mm	C mm	D mm	SW mm	kg 100	St. Pcs.
1 5010 033 016	M 16 x 1,5	13,0	12,0	38,5	22	4,800	25
1 5010 033 020	M 20 x 1,5	16,5	12,0	41,0	27	6,700	25
1 5010 033 025	M 25 x 1,5	21,0	13,0	49,0	32	11,800	10
1 5010 033 032	M 32 x 1,5	27,5	14,0	52,5	41	16,500	10
1 5010 033 040	M 40 x 1,5	35,0	17,0	63,5	46	21,000	2
1 5010 033 050	M 50 x 1,5	45,0	17,0	70,0	60	37,100	2

# STM

Blindstopfen

## MATERIAL

Messing vernickelt

## EIGENSCHAFTEN

- hohe Stabilität

Blind plug

## MATERIAL

nickel-plated brass

## PROPERTIES

- high stability

🌡️ -40°C ... +200°C

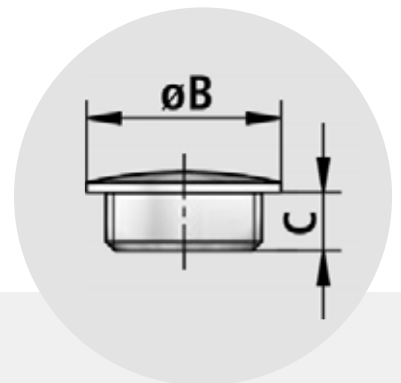

FLEXA No



C  
mm

$\varnothing B$   
mm

kg|100

St.  
pcs.

## STM – M

**Metr**  
EN 60423

FLEXA No	Metr	C mm	$\varnothing B$ mm	kg 100	St. pcs.
1 0550 001 016	M 16 x 1,5	6,0	20,0	0,500	100
1 0550 001 020	M 20 x 1,5	6,5	24,0	1,350	100
1 0550 001 025	M 25 x 1,5	7,0	28,0	2,550	100
1 0550 001 032	M 32 x 1,5	8,0	35,0	3,720	50
1 0550 001 040	M 40 x 1,5	8,0	45,0	7,000	50
1 0550 001 050	M 50 x 1,5	9,0	55,0	10,840	25

## STM – P

**PG**  
DIN 40430

FLEXA No	PG	C mm	$\varnothing B$ mm	kg 100	St. pcs.
1 0550 000 007	7	5,0	14,0	0,400	100
1 0550 000 009	9	6,0	17,0	0,660	100
1 0550 000 011	11	6,0	20,0	0,880	100
1 0550 000 013	13,5	6,5	22,0	1,100	100
1 0550 000 016	16	6,5	24,0	1,290	100
1 0550 000 021	21	7,0	30,0	2,100	100
1 0550 000 029	29	8,0	39,0	4,160	50
1 0550 000 036	36	9,0	50,0	8,040	25

🌡️ -30°C ... +100°C

# STK

Blindstopfen

## MATERIAL

Polyamid, glasfaserverstärkt

## EIGENSCHAFTEN

- beständig gegen schwache Säuren und Laugen
- beständig gegen Meerwasser, Benzin und Mineralöl

Blind plug

## MATERIAL

polyamide, fibre-glass reinforced

## PROPERTIES

- resistant against light acids and soft lyes
- resistant against sea water, benzine and mineral oil

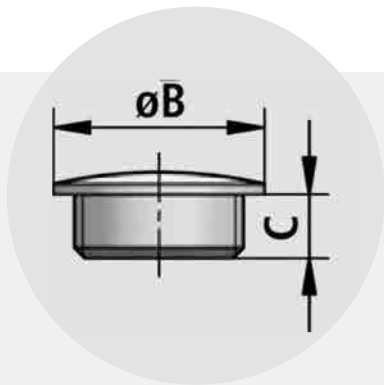

FLEXA No.

FLEXA No.



schwarz RAL 9005  
black

grau RAL 7035  
grey

C  
mm

øB  
mm

kg/100

St.  
pcs.

### STK – M

Metr.  
EN 60423

FLEXA No.	FLEXA No.	Metr.	C	øB	kg/100	St.
1 0551 001 212	1 0551 001 012	M 12 x 1,5	6,0	15,0	0,110	100
1 0551 001 216	1 0551 001 016	M 16 x 1,5	6,0	20,0	0,190	100
1 0551 001 220	1 0551 001 020	M 20 x 1,5	6,0	24,0	0,260	100
1 0551 001 225	1 0551 001 025	M 25 x 1,5	8,0	30,0	0,410	100
1 0551 001 232	1 0551 001 032	M 32 x 1,5	8,0	37,0	0,690	100
1 0551 001 240	1 0551 001 040	M 40 x 1,5	8,0	46,0	1,000	50
1 0551 001 250	1 0551 001 050	M 50 x 1,5	10,0	56,0	1,520	50

### STK – P

PG  
DIN 40430

FLEXA No.	FLEXA No.	PG	C	øB	kg/100	St.
1 0551 000 207	1 0551 000 007	7	6,0	15,0	0,120	100
1 0551 000 209	1 0551 000 009	9	6,0	19,0	0,150	100
1 0551 000 211	1 0551 000 011	11	6,0	22,0	0,210	100
1 0551 000 213	1 0551 000 013	13,5	6,0	25,0	0,260	100
1 0551 000 216	1 0551 000 016	16	6,0	27,0	0,310	100
1 0551 000 221	1 0551 000 021	21	8,0	33,0	0,480	100
1 0551 000 229	1 0551 000 029	29	8,0	44,5	0,810	100
1 0551 000 236	1 0551 000 036	36	10,0	55,5	1,400	50

# Z

 IP 68  
 -40°C ... +100°C

Adapter mit Zugentlastung  
 Außen- und Innengewinde  
 Zugentlastung nach EN 50262

Adaptor with strain relief  
 Outer and inner thread  
 strain relief acc. to EN 50262

## MATERIAL

Gehäuse      Messing vernickelt  
 Dichtung      TPE

## MATERIAL

body            nickel-plated brass  
 sealing         TPE

## VERWENDUNG

Kombinierbar mit jeder  
 Schlauchverschraubung

## APPLICATION

In combination with all  
 screw connectors

## EIGENSCHAFTEN

- hohe Stabilität

## PROPERTIES

- high stability

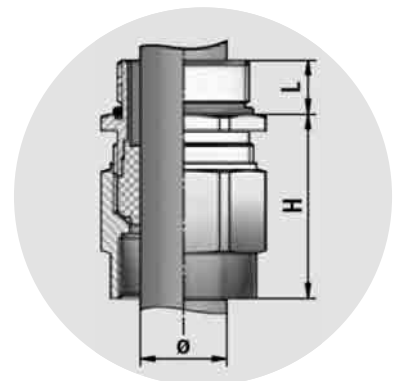

### FLEXA No.



Außen  
outer

Innen  
inner

mm

SW1  
mm

SW2  
mm

H  
mm

L  
mm

kg|100

St.  
pcs.

### Z-M

Metr.  
EN 60423

Metr.  
EN 60423

FLEXA No.	Metr. EN 60423	Metr. EN 60423	mm	SW1 mm	SW2 mm	H mm	L mm	kg 100	St. pcs.
1 0535 300 016	M 16 x 1,5	M 16 x 1,5	6,0 - 10,5	18	18	35,0	10,0	3,260	50
1 0535 300 020	M 20 x 1,5	M 20 x 1,5	8,0 - 14,5	24	24	36,0	10,0	5,880	25
1 0535 300 025	M 25 x 1,5	M 25 x 1,5	12,5 - 19,0	30	30	41,0	11,0	9,760	25
1 0535 300 032	M 32 x 1,5	M 32 x 1,5	17,0 - 25,5	36	36	46,0	13,0	12,400	25
1 0535 300 040	M 40 x 1,5	M 40 x 1,5	24,0 - 33,0	46	46	48,0	13,0	24,500	10
1 0535 300 050*	M 50 x 1,5	M 50 x 1,5	33,0 - 42,0	55	55	53,0	14,0	31,600	5

\* Lieferzeit auf Anfrage    Delivery time on request

- 🔴 IP 68 ... 5 bar
- 🌡️ -20°C ... +100°C ^ +130°C

## KSM

Kabelverschraubung

Cable gland

### MATERIAL

Gehäuse Messing vernickelt  
Dichtung Perbunan

### MATERIAL

body nickel-plated brass  
sealing perbunan

### EIGENSCHAFTEN

- beständig gegen Öl
- hohe Stabilität

### PROPERTIES

- resistant against oil
- high stability

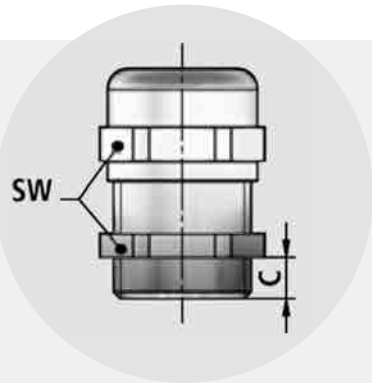

FLEXA No.



mm

C  
mm

SW  
mm

kg|100

St.  
pcs.

### KSM-M

Metr.  
EN 60423

FLEXA No.	Metr. EN 60423	mm	C mm	SW mm	kg 100	St. pcs.
1 0522 001 012	M 12 x 1,5	3,0 - 6,0	5,0	14	1,320	100
1 0522 001 016	M 16 x 1,5	5,0 - 9,0	5,0	17	1,900	100
1 0522 001 020	M 20 x 1,5	9,0 - 13,0	6,0	22	3,360	100
1 0522 001 025	M 25 x 1,5	11,0 - 16,0	7,0	27	4,800	50
1 0522 001 032	M 32 x 1,5	14,0 - 21,0	8,0	34	7,720	25
1 0522 001 040	M 40 x 1,5	19,0 - 27,0	8,0	43	13,100	10
1 0522 001 050*	M 50 x 1,5	24,0 - 35,0	9,0	55	27,800	5

### KSM-P

PG  
DIN 40430

FLEXA No.	PG DIN 40430	mm	C mm	SW mm	kg 100	St. pcs.
1 0522 000 001	7	3,0 - 6,5	5,0	14	1,050	100
1 0522 000 003	9	4,0 - 8,0	6,0	17	1,990	100
1 0522 000 006	11	5,0 - 10,0	6,0	20	2,600	50
1 0522 000 010	13,5	6,0 - 12,0	6,5	22	3,060	50
1 0522 000 013	16	10,0 - 14,0	6,5	24	3,360	50
1 0522 000 015	21	13,0 - 18,0	7,0	30	5,980	50
1 0522 000 016	29	18,0 - 25,0	8,0	40	12,080	25
1 0522 000 017	36	24,0 - 32,0	9,0	50	19,100	10
1 0522 000 019	48	34,0 - 44,0	10,0	64	31,400	5

\* Lieferzeit auf Anfrage Delivery time on request



# KSK

Kabelverschraubung

Cable gland

## MATERIAL

Gehäuse Polyamid  
Dichtung Perbunan

## MATERIAL

body polyamide  
sealing perbunan

## EIGENSCHAFTEN

- beständig gegen schwache Säuren und Laugen
- beständig gegen Meerwasser, Benzin, Mineralöl

## PROPERTIES

- resistant against light acids and soft lyes
- resistant against sea water, benzine and mineral oil

IP 68 ... 5 bar  
-20°C ... +100°C ^ +130°C

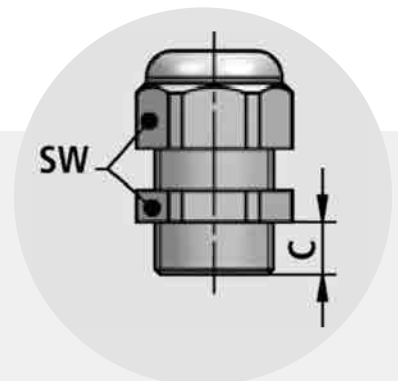

FLEXA No.	FLEXA No.					
schwarz black	grau grey		mm	C mm	SW mm	kg 100 St. pcs.
		<b>Metr. EN 60423</b>				
1 0321 001 212	1 0321 001 012	M 12 x 1,5	3,0 - 6,0	8,0	15	0,330 100
1 0321 001 216	1 0321 001 016	M 16 x 1,5	5,0 - 10,0	8,0	20	0,650 100
1 0321 001 220	1 0321 001 020	M 20 x 1,5	8,0 - 13,0	8,0	24	0,870 100
1 0321 001 225	1 0321 001 025	M 25 x 1,5	11,0 - 17,0	8,0	29	1,560 50
1 0321 001 232	1 0321 001 032	M 32 x 1,5	15,0 - 21,0	10,0	36	2,560 25
1 0321 001 240	1 0321 001 040	M 40 x 1,5	19,0 - 28,0	10,0	46	4,400 10
1 0321 001 250	1 0321 001 050	M 50 x 1,5	27,0 - 35,0	12,0	55	6,800 5
1 0321 001 263	1 0321 001 063	M 63 x 1,5	35,0 - 42,0	12,0	68	10,800 5
		<b>PG DIN 40430</b>				
1 0321 000 207	1 0321 000 007	7	3,0 - 6,5	8,0	15	0,400 100
1 0321 000 209	1 0321 000 009	9	4,0 - 8,0	8,0	19	0,590 100
1 0321 000 211	1 0321 000 011	11	5,0 - 10,0	8,0	22	0,820 100
1 0321 000 213	1 0321 000 013	13,5	6,0 - 12,0	9,0	24	0,950 100
1 0321 000 216	1 0321 000 016	16	10,0 - 14,0	10,0	27	1,220 50
1 0321 000 221	1 0321 000 021	21	13,0 - 18,0	11,0	33	2,120 50
1 0321 000 229	1 0321 000 029	29	18,0 - 25,0	11,0	42	3,720 25
1 0321 000 236	1 0321 000 036	36	22,0 - 32,0	13,0	53	6,900 10
1 0321 000 248	1 0321 000 048	48	34,0 - 44,0	14,0	65	9,600 5

-30°C ... +100°C

# DE | DEO

Dichteinsatz  
für Anschlüsse KSM | KSK | RQGZ  
RQGZ1 | RQGKZ | RQGKZE

Sealing insert  
for connectors KSM | KSK | RQGZ  
RQGZ1 | RQGKZ | RQGKZE

MATERIAL  
TPE

MATERIAL  
TPE

## EIGENSCHAFTEN

- Schutz gegen Staub und Feuchtigkeit
- DE - mit Bohrlöchern zur Durchführung mehrerer Einzelkabel
- DEO - zum Bohren von individuellen Durchgangslöchern

## PROPERTIES

- protection against dust
- DE - with bore holes for installation of several single cables
- DEO - suitable to bore individual clearance holes

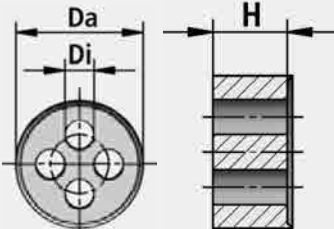

FLEXA No.



schwarz  
black

DI mm H mm Da mm St. pcs.

DE-M *	Metr. EN 60423	mit Mehrfachbohrung with bore holes			
1 0322 M12 402	M 12 x 1,5 4 x	2,0	6,6	8,5	10
1 0322 M16 204	M 16 x 1,5 2 x	4,0	7,6	11,7	10
1 0322 M20 204	M 20 x 1,5 2 x	4,0	7,5	15,1	10
1 0322 M20 206	M 20 x 1,5 2 x	6,0	7,5	15,1	10
1 0322 M20 405	M 20 x 1,5 4 x	5,0	7,5	15,1	10
1 0322 M25 206	M 25 x 1,5 2 x	6,0	9,3	19,8	10
1 0322 M25 208	M 25 x 1,5 2 x	8,0	9,3	19,8	10
1 0322 M25 304	M 25 x 1,5 3 x	4,0	9,3	19,8	10
1 0322 M25 306	M 25 x 1,5 3 x	6,0	9,3	19,8	10
1 0322 M25 307	M 25 x 1,5 3 x	7,0	9,3	19,8	10
1 0322 M25 405	M 25 x 1,5 4 x	5,0	9,3	19,8	10
1 0322 M25 406	M 25 x 1,5 4 x	6,0	9,3	19,8	10
1 0322 M25 504	M 25 x 1,5 5 x	4,0	9,3	19,8	10
1 0322 M25 604	M 25 x 1,5 6 x	4,0	9,3	19,8	10
1 0322 M32 208	M 32 x 1,5 2 x	8,0	12,5	25,1	10
1 0322 M32 308	M 32 x 1,5 3 x	8,0	12,5	25,1	10
1 0322 M32 407	M 32 x 1,5 4 x	7,0	12,5	25,1	10
1 0322 M32 408	M 32 x 1,5 4 x	8,0	12,5	25,1	10
1 0322 M32 604	M 32 x 1,5 6 x	4,0	12,5	25,1	10
1 0322 M32 606	M 32 x 1,5 6 x	6,0	12,5	25,1	10
1 0322 M40 410	M 40 x 1,5 4 x	10,0	15,0	32,3	10
1 0322 M40 585	M 40 x 1,5 5 x	8,5	15,0	32,3	10
1 0322 M40 865	M 40 x 1,5 8 x	6,5	15,0	32,3	10

\* Lieferzeit auf Anfrage Delivery time on request

FLEXA No.



schwarz  
black

DI mm H mm Da mm St. pcs.

DE-P *	PG DIN 40430	mit Mehrfachbohrung with bore holes			
1 0322 P09 203	9	2 x 3,0	7,5	10,6	10
1 0322 P09 303	9	3 x 3,5	7,5	10,6	10
1 0322 P11 203	11	2 x 3,0	8,5	13,3	10
1 0322 P11 204	11	2 x 4,0	8,5	13,3	10
1 0322 P11 205	11	2 x 5,0	8,5	13,3	10
1 0322 P11 304	11	3 x 4,0	8,5	13,3	10
1 0322 P11 305	11	3 x 5,0	8,5	13,3	10
1 0322 P11 403	11	4 x 3,0	8,5	13,3	10
1 0322 P13 205	13,5	2 x 5,0	8,5	15,3	10
1 0322 P13 206	13,5	2 x 6,0	8,5	15,3	10
1 0322 P13 304	13,5	3 x 4,0	8,5	15,3	10
1 0322 P13 305	13,5	3 x 5,0	8,5	15,3	10
1 0322 P16 204	16	2 x 4,0	9,0	17,4	10
1 0322 P16 206	16	2 x 6,0	9,0	17,4	10
1 0322 P16 305	16	3 x 5,0	9,0	17,4	10
1 0322 P16 306	16	3 x 6,0	9,0	17,4	10
1 0322 P16 307	16	3 x 7,0	9,0	17,4	10
1 0322 P16 404	16	4 x 4,0	9,0	17,4	10
1 0322 P16 405	16	4 x 5,0	9,0	17,4	10
1 0322 P16 406	16	4 x 6,0	9,0	17,4	10
1 0322 P21 207	21	2 x 7,0	11,0	22,2	10
1 0322 P21 208	21	2 x 8,0	11,0	22,2	10
1 0322 P21 209	21	2 x 9,0	11,0	22,2	10
1 0322 P21 307	21	3 x 7,0	11,0	22,2	10
1 0322 P21 308	21	3 x 8,0	11,0	22,2	10
1 0322 P21 405	21	4 x 5,0	11,0	22,2	10
1 0322 P21 407	21	4 x 7,0	11,0	22,2	10
1 0322 P29 605	29	6 x 5,0	13,0	29,8	10
1 0322 P29 805	29	8 x 5,0	13,0	29,8	10

\* Lieferzeit auf Anfrage Delivery time on request

FLEXA No.

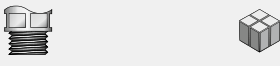

schwarz  
black

H mm Da mm St. pcs.

DEO-M *	Metr. EN 60423	ohne Bohrung without bore holes		
1 0322 M12 000	M 12 x 1,5	6,6	8,5	10
1 0322 M16 000	M 16 x 1,5	7,6	11,7	10
1 0322 M20 000	M 20 x 1,5	7,5	15,1	10
1 0322 M25 000	M 25 x 1,5	9,3	19,8	10
1 0322 M32 000	M 32 x 1,5	12,5	25,1	10
1 0322 M40 000	M 40 x 1,5	15,0	32,3	10

FLEXA No.

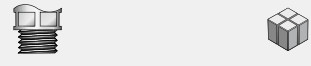

schwarz  
black

H mm Da mm St. pcs.

DEO-P *	PG DIN 40430	ohne Bohrung without bore holes		
1 0322 P07 000	7	6,5	8,3	10
1 0322 P09 000	9	7,5	10,6	10
1 0322 P11 000	11	8,5	13,3	10
1 0322 P13 000	13,5	8,5	15,3	10
1 0322 P16 000	16	9,0	17,4	10
1 0322 P21 000	21	11,0	22,2	10
1 0322 P29 000	29	14,0	30,3	10

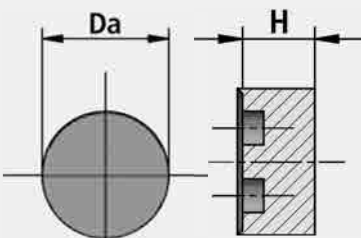

# BW

🔥 -40°C ... +200°C

Befestigungswinkel

Fastening angle

## MATERIAL

Stahl, Eloc-passiviert

## MATERIAL

steel, eloc-passivated

## KONSTRUKTION

Winkelblech mit Durchgangsbohrung und zwei Befestigungsbohrungen

## CONSTRUCTION

Angle sheet with a through-hole and two fastening bores



FLEXA No.



		øA mm	B mm	G mm	C mm	D mm	E mm	øF mm	kg 100	St. Pcs.
--	--	----------	---------	---------	---------	---------	---------	----------	--------	-------------

### BW-M

Metr.  
EN 60423

1 5010 031 016	M 16 x 1,5	17,0	22,0	38,0	50,0	40,0	20,0	4,5	3,240	25
1 5010 031 020	M 20 x 1,5	21,0	22,0	38,0	50,0	40,0	20,0	4,5	3,080	25
1 5010 031 025	M 25 x 1,5	26,0	27,0	46,9	60,0	50,0	20,0	4,5	4,120	25
1 5010 031 032	M 32 x 1,5	33,0	32,0	56,9	70,0	60,0	20,0	4,5	5,360	25
1 5010 031 040	M 40 x 1,5	41,0	37,0	67,0	80,0	70,0	20,0	4,5	6,640	25
1 5010 031 050	M 50 x 1,5	51,0	40,0	78,4	90,0	80,0	20,0	4,5	8,120	25
1 5010 031 063	M 63 x 1,5	64,0	42,0	83,0	90,0	80,0	20,0	4,5	7,040	25

### BW-P

PG  
DIN 40430

1 5010 027 016	16	23,0	22,0	38,0	50,0	40,0	20,0	4,5	2,920	25
1 5010 027 021	21	29,0	27,0	46,9	60,0	50,0	20,0	4,5	3,840	25
1 5010 027 029	29	37,5	32,0	56,9	70,0	60,0	20,0	4,5	4,840	25
1 5010 027 036	36	47,5	37,0	67,0	80,0	70,0	20,0	4,5	5,800	25
1 5010 027 048	48	60,0	42,0	78,4	90,0	80,0	20,0	4,5	6,760	25

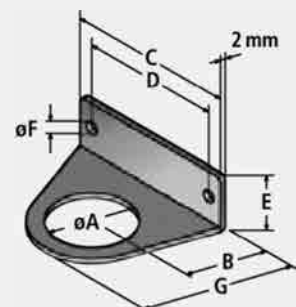

🌡️ -40°C ... +100°C

# BWK

Verschraubungs-Befestigungswinkel

Screw connector fastening angle

## MATERIAL

Kunststoff [PP]

## MATERIAL

plastics [PP]

## KONSTRUKTION

Verschraubungshalter mit zwei Befestigungsbohrungen

## CONSTRUCTION

Screw connection holder with two fastening bores

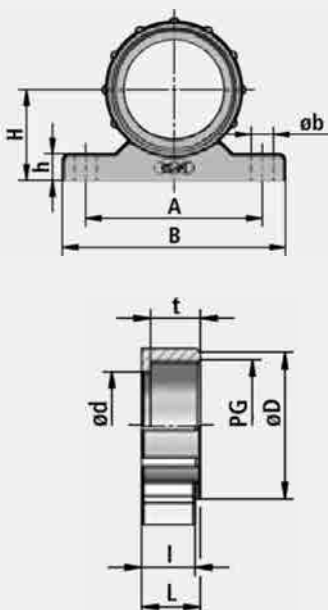

FLEXA No.



	A	B	øb	øD	ød	H	h	L	I	t	kg 100	St.
	mm	mm	mm	mm	mm	mm	mm	mm	mm	mm		pcs.

### BWK-M Metr. EN 60423

1 0315 001 020	M 20 x 1,5	37,5	50,0	5,7	27,0	15,7	20,8	7,5	13,5	12,0	11,5	0,680	50
1 0315 001 025	M 25 x 1,5	43,0	57,0	5,7	32,0	18,5	25,5	8,0	14,0	12,0	11,5	0,900	50
1 0315 001 032	M 32 x 1,5	53,5	67,5	6,7	41,0	26,8	27,8	8,0	16,5	15,0	14,0	1,460	50
1 0315 001 040	M 40 x 1,5	65,5	80,0	6,7	52,0	35,0	33,0	8,5	16,5	15,0	14,0	2,100	50
1 0315 001 050	M 50 x 1,5	69,5	86,0	6,7	59,0	43,0	36,5	9,5	17,5	15,8	15,0	2,360	50
1 0315 001 063	M 63 x 1,5	84,4	104,0	8,2	70,0	56,5	46,8	12,1	23,5	21,5	20,6	3,960	25

### BWK-P PG DIN 40430

1 0315 000 009	9	29,0	40,0	5,7	19,0	10,5	14,5	6,0	14,0	12,0	11,5	0,400	50
1 0315 000 011	11	37,0	50,0	5,7	27,0	13,0	20,0	7,0	14,0	12,0	11,5	0,800	50
1 0315 000 013	13,5	37,0	50,0	5,7	27,0	15,5	20,0	7,0	14,0	12,0	11,5	0,680	50
1 0315 000 016	16	37,0	50,0	5,7	27,0	17,5	20,0	7,0	14,0	12,0	11,5	0,604	50
1 0315 000 021	21	43,0	57,0	5,7	32,0	22,0	25,0	8,0	14,0	12,0	11,5	0,720	50
1 0315 000 029	29	53,0	67,0	6,7	41,0	30,0	27,5	8,0	16,5	15,0	14,0	1,160	25
1 0315 000 036	36	65,0	80,0	6,7	52,0	39,0	33,0	8,5	16,5	15,0	14,0	1,560	25
1 0315 000 048	48	76,0	93,0	6,7	65,0	53,0	38,5	10,0	19,0	16,5	16,0	2,360	25

# SKM

Schlauch-Klemmschelle

Tubing-Clamp

## MATERIAL

Stahl verzinkt mit Gummiprofil

## MATERIAL

galvanized steel with rubber-profile

## KONSTRUKTION

Rohrschelle mit Gummiprofil und verstärkten Befestigungsbohrungen

## KONSTRUKTION

Pipe holder with through hole for fastening with screws

-40°C ... +120°C



FLEXA No.

AD  
OD



ø

øF  
mm

D  
mm

E  
mm

kg|100

St.  
pcs.

## SKM

FLEXA No.	AD OD	øF mm	D mm	E mm	kg 100	St. pcs.
1 0308 000 007	10,0	M 5	15,5	15,0	0,380	50
1 0308 012 013	13,0	M 5	19,0	15,0	0,420	50
1 0308 000 009	14,0	M 5	19,0	15,0	0,460	50
1 0308 012 016	15,8	M 5	28,0	15,0	0,640	50
1 0308 000 011	17,0	M 5	22,0	15,0	0,810	50
1 0308 012 019	18,5	M 5	25,0	16,0	0,830	50
1 0308 000 013	19,0 – 20,0	M 5	25,0	16,0	0,860	50
1 0308 000 016	21,0 – 22,0	M 5	22,0	15,5	0,930	50
1 0308 000 021	27,0 – 29,0	M 6	35,0	18,0	2,040	50
1 0308 000 029	34,5 – 36,0	M 6	40,0	18,5	4,380	50
1 0308 000 036	42,5 – 45,0	M 6	50,0	18,5	7,980	25
1 0308 000 048	54,5 – 57,0	M 6	74,5	18,5	10,430	25

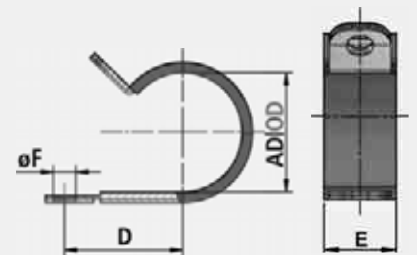

# SKM–Multi

Schlauch-Klemmschelle für Kabelsammler ROHRflex®-Multi

Tubing-Clamp for cable buncher ROHRflex®-Multi

## MATERIAL

Stahl verzinkt mit Gummiprofil

## MATERIAL

galvanized steel with rubber-profile

## KONSTRUKTION

Rohrschelle mit Gummiprofil und verstärkten Befestigungsbohrungen

## KONSTRUKTION

Pipe holder with through hole for fastening with screws



FLEXA No.

LW  
ID



ø

øF  
mm

ø  
mm

E  
mm

kg|100

St.  
pcs.





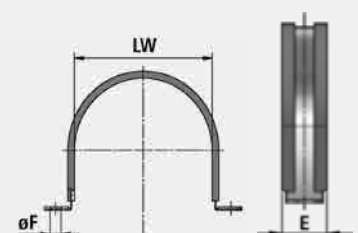



## SKM–Multi

FLEXA No.	LW ID	øF mm	ø mm	E mm	kg 100	St. pcs.
1 0308 000 070	70	M 8	79,0	20,0	7,000	1
1 0308 000 095	95	M 8	105,0	20,0	9,000	1



# 10 FÜHRUNGSKETTEN GUIDE CHAINS

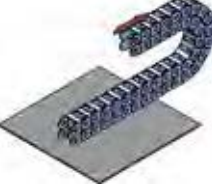

	<p>Standard - freitragend standard - free carrying</p>		<p>Kreisförmig circular</p>		<p>Standard - gleitend standard - gliding</p>
	<p>Kombiniert - vertikal und horizontal combined - vertical and horizontal motions</p>		<p>Vertikal hängend vertical hanging</p>		<p>Standard - nebeneinander standard side-by-side</p>
	<p>Vertikal stehend vertical standing</p>		<p>Standard - ineinander standard adjacent</p>		<p>Seitlich liegend sideways</p>
<p>EINBAUVARIANTEN VARIATIONS</p>					 <p>Gegenläufig counter rotating</p>

**Führungskette PL**  
Kunststoff  
PL Guide chain  
plastics



10. 2

---

**Führungskette PH**  
Kunststoff | Aluminium  
PH Guide chain  
plastics | aluminium



10.10

---

**Rinnensystem**  
Channel system



10.19

---

**Technische Informationen**  
Technical data

10.23

---

🔥 -40°C ... +135°C

## PL

Kunststoff-Führungsketten  
Standard

Plastic guide chains  
standard

### MATERIAL

Kunststoff PA6 GFK

### MATERIAL

PA6 GFK plastics

### EIGENSCHAFTEN

- aufklappbar
- per Hand zu öffnen und zu schließen
- optimales Verhältnis von Wandstärke und Innenraum
- wirtschaftlich
- lange Lebensdauer
- über die gesamte Innenbreite zu befüllen
- Lieferung in Meterstücken [Standard]

### PROPERTIES

- hinged
- to be opened manually – quick and easy
- optimized wall thickness / interior ratio
- economical
- extended lifetime
- loadable across entire inner chain width
- delivered in sections of 1 meter [standard]

### ANWENDUNGSGEBIETE

- Automation
- [Sonder-] Maschinenbau
- Anlagenbau
- Tore
- Aufzüge

### APPLICATION

- automation
- [special-purpose] machines
- plant construction
- doors
- elevators

### VORSPANNUNG

FLEXA Führungsketten haben eine Vorspannung, um eine möglichst große freitragende Länge zu erreichen. Diese wird auch durch andere Parameter beeinflusst. Alle FLEXA Führungsketten werden mit Vorspannung gefertigt. Auf Wunsch können alle Kettentypen auch ohne Vorspannung geliefert werden.

### PRESTRESSED

The FLEXA guide chains are prestressed in order to achieve the longest possible free carrying length. This length is also determined through other parameters such as the weight of the guide chain load. We also supply our range as prestress-free guide chains, if requested.

### ZUSATZGEWICHT

[Leitungen] der Führungskette

Für Leitungen, die in die Führungskette eingelegt werden, muss das Gesamtgewicht pro Meter Kettenlänge ermittelt werden.

Für alle FLEXA Kettentypen kann das zulässige Zusatzgewicht den jeweiligen Tabellen [Technische Informationen] entnommen werden.

### ADDITIONAL LOAD

[Cables] for the guide chain

In order to determine the additional weight of the guide chain it is necessary to determine the particular weight of such wires, cables, and hoses. This information is provided in the technical data issued by the particular manufacturer. Please check with the relevant tables in our catalogue concerning the permissible FLEXA guide chain gross weight.



# PL3

-40°C ... +135°C

## TECHNISCHE DATEN

## TECHNICAL DATA

Innenhöhe	<b>Hi</b>	Inner height	18 mm
Außenhöhe	<b>Ha</b>	Outer height	22 mm
Anzahl Kettenglieder/m		Number of chain links/meter	31
Teilung	<b>T</b>	Pitch	32 mm
Kettenlänge		Guide chain length	ca.   appr. L/2 + BL
Bauhöhe	<b>H</b>	Total height	ca.   appr. 2 x R + 22 mm
Freitragende Länge		Free carrying length	max. 1750 mm
Verfahrweg Standard	<b>L</b>	Travel standard	max. 35 m
Verfahrweg in Rinne		Travel in channel	max. 60 m
Zusatzgewicht		Load	max. 4,0 kg/m
Geschwindigkeit		Speed	max. 10 m/sec
Beschleunigung		Acceleration	max. 10 m/sec <sup>2</sup>
Zugbelastbarkeit		Tensile strength	max. 1350 N
Trennstegdicke		Separator thickness	1,25 mm

<b>Bi</b>	Innenbreite	Inner width
<b>Ba</b>	Außenbreite	Outer width
<b>BL</b>	Bogenlänge	Bow length
<b>H</b>	Bauhöhe	Total height
<b>Ha</b>	Außenhöhe	Outer height
<b>Hi</b>	Innenhöhe	Inner height
<b>L</b>	Verfahrweg	Travel length
<b>O</b>	Öffnungsbreite	Opening
<b>R</b>	Radius	Radius
<b>T</b>	Teilung	Pitch
<b>TS</b>	Trennstege	Separators



VIDEO

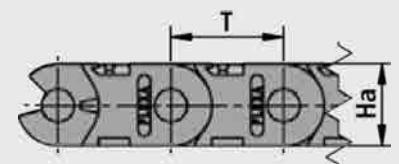
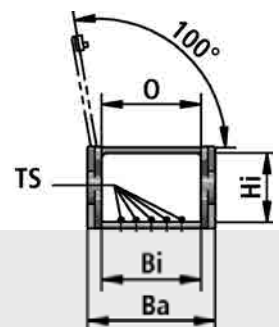
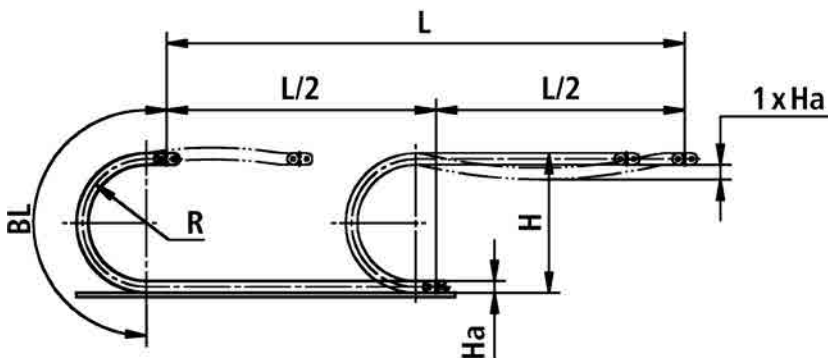

### FLEXA No.

 Artikel  
article

TS



schwarz black		Bi mm	R mm	Ba mm	BL mm	St./pcs. max.	kg/m	m*
1 6023 031 003	PL3-31-3F	31	35	41	140	4	0,350	1
1 6023 031 005	PL3-31-5F	31	50	41	200	4	0,350	1
1 6023 031 007	PL3-31-7F	31	70	41	280	4	0,350	1
1 6023 031 010	PL3-31-10F	31	100	41	400	4	0,350	1

\* mit 31 Kettengliedern kpl. vormontiert with 31 guide links pre-assembled

-40°C ... +135°C

<b>Bi</b>	Innenbreite	Inner width
<b>Ba</b>	Außenbreite	Outer width
<b>BL</b>	Bogenlänge	Bow length
<b>H</b>	Bauhöhe	Total height
<b>Ha</b>	Außenhöhe	Outer height
<b>Hi</b>	Innenhöhe	Inner height
<b>L</b>	Verfahrweg	Travel length
<b>O</b>	Öffnungsbreite	Opening
<b>R</b>	Radius	Radius
<b>T</b>	Teilung	Pitch
<b>TS</b>	Trennstege	Separators



VIDEO



## PL4

### TECHNISCHE DATEN

Innenhöhe	<b>Hi</b>
Außenhöhe	<b>Ha</b>
Anzahl Kettenglieder/m	
Teilung	<b>T</b>
Kettenlänge	
Bauhöhe	<b>H</b>
Freitragende Länge	
Verfahrweg Standard	<b>L</b>
Verfahrweg in Rinne	
Zusatzgewicht	
Geschwindigkeit	
Beschleunigung	
Zugbelastbarkeit	
Trennsteigdicke	

### TECHNICAL DATA

Inner height	25 mm
Outer height	30 mm
Number of chain links/meter	22
Pitch	45 mm
Guide chain length	ca.   appr. L/2 + BL
Total height	ca.   appr. 2 x R + Ha
Free carrying length	max. 2300 mm
Travel standard	max. 50 m
Travel in channel	max. 100 m
Load	max. 7,5 kg/m
Speed	max. 10 m/sec
Acceleration	max. 10 m/sec <sup>2</sup>
Tensile strength	max. 2200 N
Separator thickness	2 mm

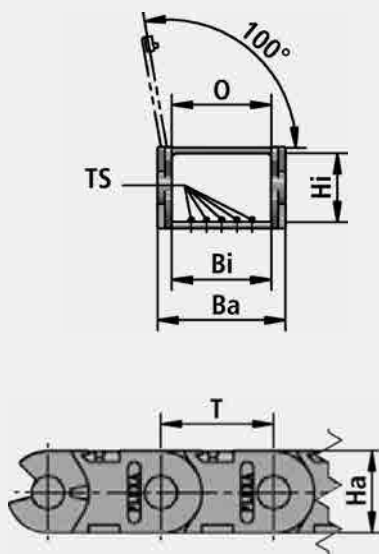
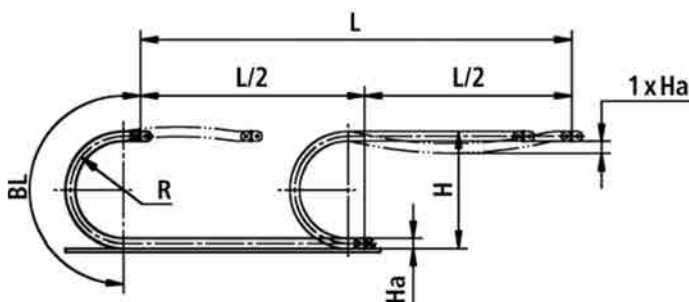

### FLEXA No.

Artikel  
article



schwarz black		Bi mm	R mm	Ba mm	BL mm	St.   pcs. max.	kg m	m*
1 6024 038 005	PL4-38-5F	38	50	50	200	3	0,500	1
1 6024 038 007	PL4-38-7F	38	75	50	300	3	0,500	1
1 6024 038 010	PL4-38-10F	38	100	50	400	3	0,500	1
1 6024 038 015	PL4-38-15F	38	150	50	600	3	0,500	1
1 6024 038 020	PL4-38-20F	38	200	50	800	3	0,500	1
1 6024 048 005	PL4-48-5F	48	50	60	200	5	0,530	1
1 6024 048 007	PL4-48-7F	48	75	60	300	5	0,530	1
1 6024 048 010	PL4-48-10F	48	100	60	400	5	0,530	1
1 6024 048 015	PL4-48-15F	48	150	60	600	5	0,530	1
1 6024 048 020	PL4-48-20F	48	200	60	800	5	0,530	1
1 6024 068 005	PL4-68-5F	68	50	80	200	7	0,590	1
1 6024 068 007	PL4-68-7F	68	75	80	300	7	0,590	1
1 6024 068 010	PL4-68-10F	68	100	80	400	7	0,590	1
1 6024 068 015	PL4-68-15F	68	150	80	600	7	0,590	1
1 6024 068 020	PL4-68-20F	68	200	80	800	7	0,590	1
1 6024 083 005	PL4-83-5F	83	50	95	200	9	0,630	1
1 6024 083 007	PL4-83-7F	83	75	95	300	9	0,630	1
1 6024 083 010	PL4-83-10F	83	100	95	400	9	0,630	1
1 6024 083 015	PL4-83-15F	83	150	95	600	9	0,630	1
1 6024 083 020	PL4-83-20F	83	200	95	800	9	0,630	1
1 6024 113 005	PL4-113-5F	113	50	125	200	13	0,700	1
1 6024 113 007	PL4-113-7F	113	75	125	300	13	0,700	1
1 6024 113 010	PL4-113-10F	113	100	125	400	13	0,700	1
1 6024 113 015	PL4-113-15F	113	150	125	600	13	0,700	1
1 6024 113 020	PL4-113-20F	113	200	125	800	13	0,700	1

\* mit 22 Kettengliedern kpl. vormontiert with 22 guide links pre-assembled

# PL5

-40°C ... +135°C

## TECHNISCHE DATEN

## TECHNICAL DATA

Innenhöhe	<b>Hi</b>	Inner height	34 mm
Außenhöhe	<b>Ha</b>	Outer height	40 mm
Anzahl Kettenglieder/m		Number of chain links/meter	18
Teilung	<b>T</b>	Pitch	55 mm
Kettenlänge		Guide chain length	ca.   appr. L/2 + BL
Bauhöhe	<b>H</b>	Total height	ca.   appr. 2 x R + Ha
Freitragende Länge		Free carrying length	max. 3100 mm
Verfahrweg Standard	<b>L</b>	Travel standard	max. 75 m
Verfahrweg in Rinne		Travel in channel	max. 120 m
Zusatzgewicht		Load	max. 8,0 kg/m
Geschwindigkeit		Speed	max. 10 m/sec
Beschleunigung		Acceleration	max. 10 m/sec <sup>2</sup>
Zugbelastbarkeit		Tensile strength	max. 4300 N
Trennstegdicke		Separator thickness	2 mm

<b>Bi</b>	Innenbreite	Inner width
<b>Ba</b>	Außenbreite	Outer width
<b>BL</b>	Bogenlänge	Bow length
<b>H</b>	Bauhöhe	Total height
<b>Ha</b>	Außenhöhe	Outer height
<b>Hi</b>	Innenhöhe	Inner height
<b>L</b>	Verfahrweg	Travel length
<b>O</b>	Öffnungsbreite	Opening
<b>R</b>	Radius	Radius
<b>T</b>	Teilung	Pitch
<b>TS</b>	Trennstege	Separators



VIDEO

### FLEXA No.

 Artikel  
article

schwarz black			Bi mm	R mm	Ba mm	BL mm	St. pcs. max.	kg m	m*
1 6025 049 006	PL5-49-6F	49	60	63	240	5	0,950	1	
1 6025 049 010	PL5-49-10F	49	100	63	400	5	0,950	1	
1 6025 049 012	PL5-49-12F	49	125	63	500	5	0,950	1	
1 6025 049 015	PL5-49-15F	49	150	63	600	5	0,950	1	
1 6025 049 020	PL5-49-20F	49	200	63	800	5	0,950	1	
1 6025 049 025	PL5-49-25F	49	250	63	1000	5	0,950	1	
1 6025 061 006	PL5-61-6F	61	60	75	240	7	0,980	1	
1 6025 061 010	PL5-61-10F	61	100	75	400	7	0,980	1	
1 6025 061 012	PL5-61-12F	61	125	75	500	7	0,980	1	
1 6025 061 015	PL5-61-15F	61	150	75	600	7	0,980	1	
1 6025 061 020	PL5-61-20F	61	200	75	800	7	0,980	1	
1 6025 061 025	PL5-61-25F	61	250	75	1000	7	0,980	1	
1 6025 081 006	PL5-81-6F	81	60	95	240	9	1,050	1	
1 6025 081 010	PL5-81-10F	81	100	95	400	9	1,050	1	
1 6025 081 012	PL5-81-12F	81	125	95	500	9	1,050	1	
1 6025 081 015	PL5-81-15F	81	150	95	600	9	1,050	1	
1 6025 081 020	PL5-81-20F	81	200	95	800	9	1,050	1	
1 6025 081 025	PL5-81-25F	81	250	95	1000	9	1,050	1	
1 6025 111 006	PL5-111-6F	111	60	125	240	13	1,120	1	
1 6025 111 010	PL5-111-10F	111	100	125	400	13	1,120	1	
1 6025 111 012	PL5-111-12F	111	125	125	500	13	1,120	1	
1 6025 111 015	PL5-111-15F	111	150	125	600	13	1,120	1	
1 6025 111 020	PL5-111-20F	111	200	125	800	13	1,120	1	
1 6025 111 025	PL5-111-25F	111	250	125	1000	13	1,120	1	
1 6025 135 006	PL5-135-6F	135	60	149	240	15	1,180	1	
1 6025 135 010	PL5-135-10F	135	100	149	400	15	1,180	1	
1 6025 135 012	PL5-135-12F	135	125	149	500	15	1,180	1	
1 6025 135 015	PL5-135-15F	135	150	149	600	15	1,180	1	
1 6025 135 020	PL5-135-20F	135	200	149	800	15	1,180	1	
1 6025 135 025	PL5-135-25F	135	250	149	1000	15	1,180	1	
1 6025 177 006	PL5-177-6F	177	60	191	240	21	1,290	1	
1 6025 177 010	PL5-177-10F	177	100	191	400	21	1,290	1	
1 6025 177 012	PL5-177-12F	177	125	191	500	21	1,290	1	
1 6025 177 015	PL5-177-15F	177	150	191	600	21	1,290	1	
1 6025 177 020	PL5-177-20F	177	200	191	800	21	1,290	1	
1 6025 177 025	PL5-177-25F	177	250	191	1000	21	1,290	1	

\* mit 18 Kettengliedern kpl. vormontiert with 18 guide links pre-assembled

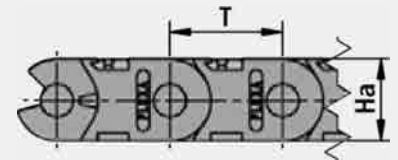
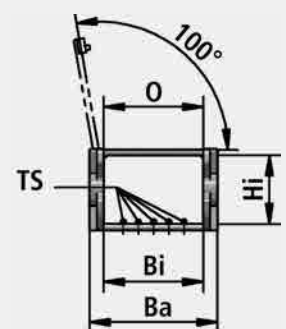

## ANSCHLÜSSE UND ZUBEHÖR CONNECTION PARTS

- Anschlüsse sind variabel und unabhängig von der Kettenbreite einsetzbar
- mit Zugentlastung kombinierbar
- preisgünstiges Anschlussystem
- connection parts are very variable and do not depend on the inside width
- can be combined with a strain relief system
- favourably priced connection system



### Anschluss mit Zugentlastung PBZ

- zum Anschluss und zur Befestigung
- Set bestehend aus zwei Anschulsteile [R / L]
- mit Zugentlastungskamm

### PBZ connector with strain relief

- for connection and fixation
- set includes two connecting parts [R / L]
- with tiwrap plates

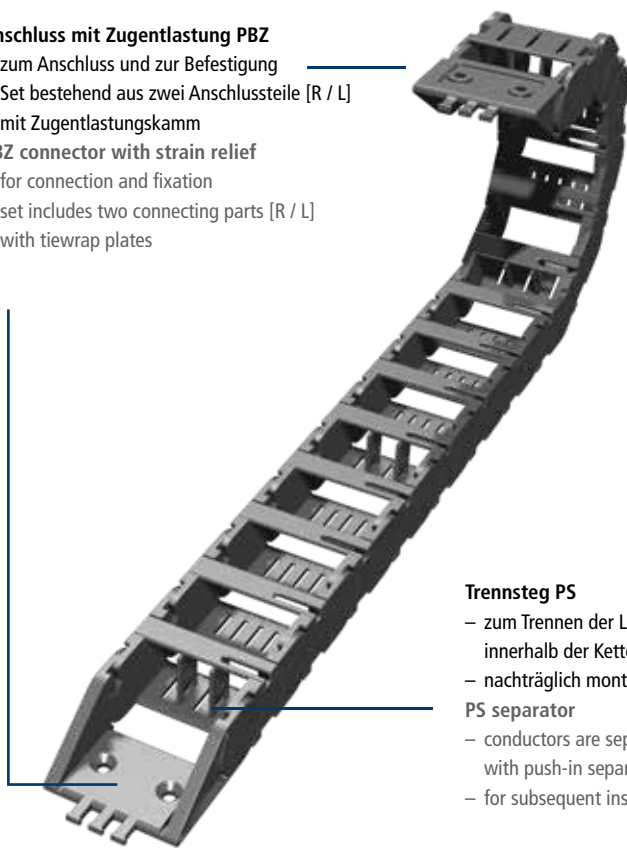

### Trennsteg PS

- zum Trennen der Leitungen innerhalb der Kette
  - nachträglich montierbar
- PS separator
- conductors are separated with push-in separators
  - for subsequent installation

## PS

Trennsteg PS

### MATERIAL

Kunststoff PA6 GFK

### EIGENSCHAFTEN

- zum Trennen der Leitungen innerhalb der Kette
- nachträglich montierbar
- optimal in jedem zweiten Kettenglied

PS separator

### MATERIAL

PA6 GFK plastics

### PROPERTIES

- conductors are separated with push-in separators
- also applicable for subsequent installation
- best applied in every second chain link

FLEXA No.	Artikel article	Typ type	Breite width	St. pcs.
schwarz black			mm	
1 6143 000 000	PS35N	PL3	2,0	25
1 6144 000 000	PS4N	PL4	2,0	25
1 6145 000 000	PS5N	PL5	2,0	25

## PBZ

Anschluss mit Zugentlastung PBZ

PBZ connector with strain relief

### MATERIAL

Kunststoff PA6 GFK

### MATERIAL

PA6 GFK plastics

### EIGENSCHAFTEN



- zum Anschluss und Befestigung der Führungsketten PL
- Set bestehend aus zwei Anschlussteilen (R / L)
- mit Zugentlastungskamm
- Langloch-Befestigungsbohrung zur einfacheren Fixierung

### PROPERTIES

- connection and fixation of the PL guide chains
- set includes two connecting parts (R / L)
- with tiwrap plates
- slot-mounting holes for easier fixation

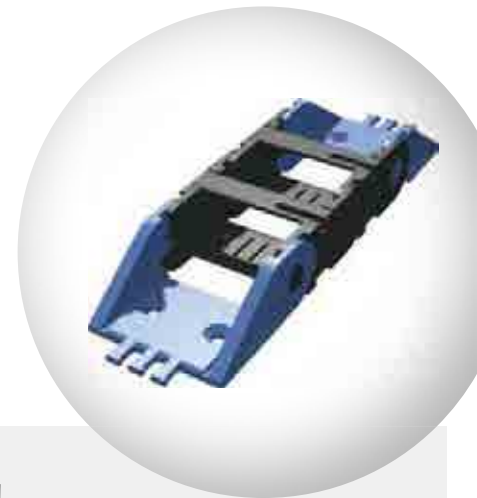
## ANSCHLÜSSE UND ZUBEHÖR CONNECTION PARTS



FLEXA No.	Artikel article	Typ type								Kämme tiwrap plates	
			Bi mm	E0 mm	G mm	F mm	N mm	S mm	Anzahl number		
schwarz black											
1 6153 031 000	PBZ3-31	PL3	31,0	41,0	6,5	10,0	30	16	3	1	
1 6154 038 000	PBZ4-38	PL4	38,0	50,0	6,1	22,0	32	-	3	1	
1 6154 048 000	PBZ4-48	PL4	48,0	60,0	6,1	30,0	32	-	3	1	
1 6154 068 000	PBZ4-68	PL4	68,0	80,0	6,1	44,0	32	-	5	1	
1 6155 061 000	PBZ5-61	PL5	61,0	75,0	6,1	45,0	42	-	5	1	
1 6155 081 000	PBZ5-81	PL5	81,0	95,0	6,1	55,0	42	-	7	1	
1 6155 111 000	PBZ5-111	PL5	111,0	125,0	6,1	80,0	42	-	9	1	

Bi = Innenbreite Bi = Inner width

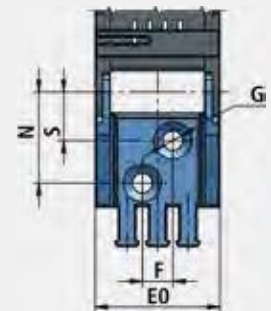

## PB

Standardanschluss PB

PB standard connector

### MATERIAL

Kunststoff PA6 GFK

### MATERIAL

PA6 GFK plastics



### EIGENSCHAFTEN

- zur seitlichen Befestigung der Führungsketten PL
- stabilisiert die Führung

### PROPERTIES

- for lateral fixation of the PL guide chains
- stabilizes the guide



FLEXA No.	Artikel article	Typ type				
			E0 mm	F mm	G mm	
schwarz black						
1 6154 000 002	PB4	PL4	Bi + 30,5	Bi + 18,5	5,5	1
1 6155 000 002	PB5	PL5	Bi + 35,5	Bi + 21,5	5,5	1

Bi = Innenbreite Bi = Inner width

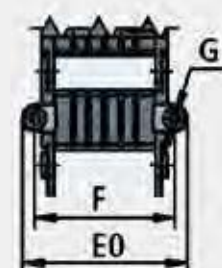

## ANSCHLÜSSE UND ZUBEHÖR

### CONNECTION PARTS

# PB-L | PB-R | PB-V

Flachanschluss PB-L

PB-L flat connector

### MATERIAL

Kunststoff PA6 GFK

### MATERIAL

PA6 GFK plastics

### EIGENSCHAFTEN

- zur Befestigung der Führungsketten PL an der Stirnseite, laschenseitig
- optimal mit M5 Senkkopfschraube

### PROPERTIES

- applied to fix the PL guide chains on the front side – slack side
- optimal with M5 countersunk screw



A

### FLEXA No.

Artikel  
article

Typ  
type



schwarz black			E0 mm	F mm	G mm	S mm	U mm	St. Pcs.
1 6154 000 102	PB4 L	PL4	Bi + 16	Bi + 6	5,2	19,5	30,0	2
1 6155 000 100	PB5 L	PL5	Bi + 19	Bi + 7	5,2	26,0	40,0	2

A

Bi = Innenbreite Inner width

Flachanschluss PB-R

PB-R flat connector

### MATERIAL

Kunststoff PA6 GFK

### MATERIAL

PA6 GFK plastics

### EIGENSCHAFTEN

- zur Befestigung der Führungsketten PL an der Stirnseite, radienseitig
- optimal mit M5 Senkkopfschraube

### PROPERTIES

- applied to fix the PL guide chains on the front side – radial side
- optimal with M5 countersunk screw



B

### FLEXA No.

Artikel  
article

Typ  
type



schwarz black			E0 mm	F mm	G mm	S mm	U mm	St. Pcs.
1 6154 000 202	PB4 R	PL4	Bi + 16	Bi + 6	5,2	19,5	30,0	2
1 6155 000.200	PB5 R	PL5	Bi + 19	Bi + 7	5,2	26,0	40,0	2

B

Bi = Innenbreite Inner width

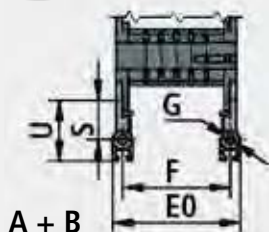

A + B

Stabiler Flachanschluss PB-V

PB-V heavy-duty flat connector

### MATERIAL

Kunststoff PA6 GFK

### MATERIAL

PA6 GFK plastics

### EIGENSCHAFTEN

- zur Befestigung der Führungsketten PL an der Stirnseite
- optimal mit M5 Senkkopfschraube

### PROPERTIES

- applied to fix the PL guide chains on the front side
- optimal with M5 countersunk screw

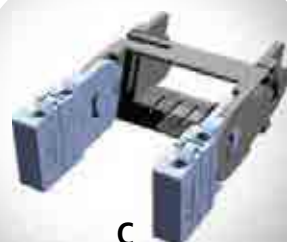

C

### FLEXA No.

Artikel  
article

Typ  
type



schwarz black			E0 mm	F mm	G mm	S mm	N mm	St. Pcs.
1 6154 000 109	PB4 LV	PL4	Bi + 16	Bi + 6	5,2	19,5	15,5	2
1 6154 000 209	PB4 RV	PL4	Bi + 16	Bi + 6	5,2	19,5	15,5	2
1 6155 000 104	PB5 LV	PL5	Bi + 19	Bi + 7	5,2	26,0	19,0	2
1 6155 000 204	PB5 RV	PL5	Bi + 19	Bi + 7	5,2	26,0	19,0	2

C

Bi = Innenbreite Inner width

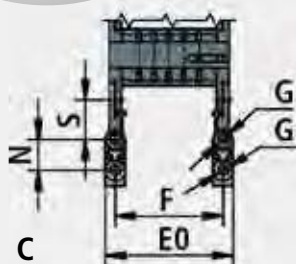

C

# PL

## ÖFFNEN UND SCHLIESSEN

Zum Öffnen den Klappsteg an der geschlitzten Seite zusammendrücken. Den Klappsteg unter leichter Spannung aus der Verriegelung lösend anheben. Die Führungskette ist über die gesamte Innenbreite zugänglich.

Zum Schließen umgekehrt verfahren.

## OPENING AND CLOSING

To open the guide chain squeeze the hinged bridge on the slotted side and release the bridge by lifting the profile sideways. Guide chains are accessible across the entire inner width.

To close the profile proceed in reverse order.

## MONTAGEHINWEISE

### ASSEMBLY INSTRUCTIONS



## VERLÄNGERN UND KÜRZEN

Zum Verlängern oder Kürzen der Kette öffnen Sie die Führungskette an den beiden folgenden Gliedern. Danach sind die Grundkörper durch einfaches Zusammendrücken zu lösen bzw. zusammen zu stecken.

## LENGTHENING AND SHORTENING

To lengthen or shorten the chain open the particular chain section at the neighbouring chain link(s). Then loosen or stick together both chain ends by pressing the base body.



## MONTAGE DER TRENNSTEGE

Leitungen werden mit Trennstegen getrennt, diese werden von außen durch den Boden eingeschoben bis sie einrasten. Durch Entriegeln der Verriegelung sind sie wieder zu entfernen.

## MOUNTING THE SEPARATORS

Conductors will be separated with push-in separators. The separators have to be pushed from the outside through the bottom of the guide chain until they lock. The separator can be removed by unlocking the locking device.



🔥 -40°C ... +135°C

## PH

Kunststoff-Führungsketten  
variabel, hochbelastbar

Plastic guide chains  
variable, highly stressable

### MATERIAL

Lasche Kunststoff PA6 GFK  
Rahmenstege Aluminium

### MATERIAL

Link plates PA6 GFK plastics  
Frame bar aluminium

### EIGENSCHAFTEN

- einfache Montage
- wirtschaftlich
- stabil für eine lange Lebensdauer
- Innen- / bzw. Außenbreite bis ca. 600 mm möglich
- Anschlussmaße kompatibel
- einfache Handhabung mit handelsüblichen Werkzeugen

### PROPERTIES

- easy to mount
- economical
- designed for extended lifetime
- inner / outer widths up to approx. 600 mm available
- compatible connections
- simple handling with standard tools

### ANWENDUNGSGEBIETE

- Automation
- [Sonder-] Maschinenbau
- Anlagenbau
- Tore
- Aufzüge

### APPLICATION

- automation
- [special-purpose] machines
- plant construction
- doors
- elevators



### VORSPANNUNG

FLEXA Führungsketten haben eine Vorspannung, um eine möglichst große freitragende Länge zu erreichen. Diese wird auch durch andere Parameter beeinflusst. Alle FLEXA Führungsketten werden mit Vorspannung gefertigt. Auf Wunsch können alle Kettentypen auch mit verminderter Vorspannung gefertigt werden.

### PRESTRESSED

The FLEXA guide chains are prestressed in order to achieve the longest possible free carrying length. This length is also determined through other parameters such as the weight of the guide chain load. We also supply our range as prestress-reduced guide chains, if requested.

### ZUSATZGEWICHT

[Leitungen] der Führungskette

Für Leitungen, die in die Führungskette eingelegt werden, muss das Gesamtgewicht pro Meter Kettenlänge ermittelt werden.

Für alle FLEXA Kettentypen kann das zulässige Zusatzgewicht den jeweiligen Tabellen [Technische Informationen] entnommen werden.

### ADDITIONAL LOAD

[Cables] for the guide chain

In order to determine the additional weight of the guide chain it is necessary to determine the particular weight of such wires, cables, and hoses. This information is provided in the technical data issued by the particular manufacturer. Please check with the relevant tables in our catalogue concerning the permissible FLEXA guide chain gross weight.



# PH7

🌡️ -40°C ... +135°C

## TECHNISCHE DATEN

## TECHNICAL DATA

Innenhöhe	<b>Hi</b>	Inner height		34 mm
Außenhöhe	<b>Ha</b>	Outer height		52 mm
Kettenglieder montiert/m		Chain links assembled/meter		14
Teilung	<b>T</b>	Pitch		70 mm
Kettenlänge		Guide chain length	ca.   appr.	L/2 + BL
Bauhöhe	<b>H</b>	Total height	ca.   appr.	2 x R + Ha
Freitragende Länge		Free carrying length	max.	3500 mm
Verfahrweg Standard	<b>L</b>	Travel standard	max.	35 m
Verfahrweg in Rinne		Travel in channel	max.	60 m
Zusatzgewicht		Load	max.	20 kg/m
Geschwindigkeit		Speed	max.	10 m/sec
Beschleunigung		Acceleration	max.	15 m/sec <sup>2</sup>
Zugbelastbarkeit		Tensile strength	max.	1350 N
Trennstegdicke		Separator thickness		4 mm

<b>Bi</b>	Innenbreite	Inner width
<b>Ba</b>	Außenbreite	Outer width
<b>BL</b>	Bogenlänge	Bow length
<b>H</b>	Bauhöhe	Total height
<b>Ha</b>	Außenhöhe	Outer height
<b>Hi</b>	Innenhöhe	Inner height
<b>L</b>	Verfahrweg	Travel length
<b>O</b>	Öffnungsbreite	Opening
<b>R</b>	Radius	Radius
<b>T</b>	Teilung	Pitch
<b>TS</b>	Trennstege	Separators



VIDEO

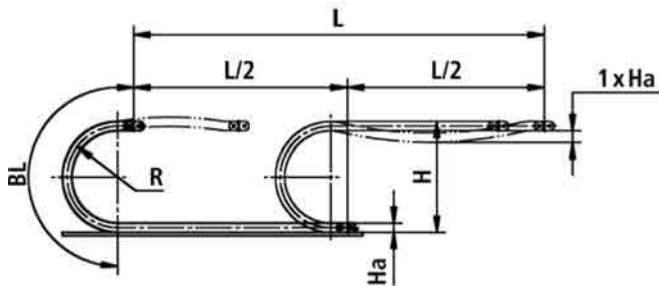

### FLEXA No

Artikel article



schwarz black	FLEXA No	Artikel article	Bi mm	R mm	Ba mm	BL mm	St.   pcs max	kg   m	m*
1 6097 050 007	PH7-50A-7F		50	75	76	300	3	1,670	1
1 6097 050 010	PH7-50A-10F		50	100	76	400	3	1,670	1
1 6097 050 015	PH7-50A-15F		50	150	76	600	3	1,670	1
1 6097 050 020	PH7-50A-20F		50	200	76	800	3	1,670	1
1 6097 050 030	PH7-50A-30F		50	300	76	1200	3	1,670	1
1 6097 065 007	PH7-65A-7F		65	75	91	300	4	1,720	1
1 6097 065 010	PH7-65A-10F		65	100	91	400	4	1,720	1
1 6097 065 015	PH7-65A-15F		65	150	91	600	4	1,720	1
1 6097 065 020	PH7-65A-20F		65	200	91	800	4	1,720	1
1 6097 065 030	PH7-65A-30F		65	300	91	1200	4	1,720	1
1 6097 100 007	PH7-100A-7F		100	75	126	300	7	1,850	1
1 6097 100 010	PH7-100A-10F		100	100	126	400	7	1,850	1
1 6097 100 015	PH7-100A-15F		100	150	126	600	7	1,850	1
1 6097 100 020	PH7-100A-20F		100	200	126	800	7	1,850	1
1 6097 100 030	PH7-100A-30F		100	300	126	1200	7	1,850	1
1 6097 150 007	PH7-150A-7F		150	75	176	300	10	2,030	1
1 6097 150 010	PH7-150A-10F		150	100	176	400	10	2,030	1
1 6097 150 015	PH7-150A-15F		150	150	176	600	10	2,030	1
1 6097 150 020	PH7-150A-20F		150	200	176	800	10	2,030	1
1 6097 150 030	PH7-150A-30F		150	300	176	1200	10	2,030	1
1 6097 200 007	PH7-200A-7F		200	75	226	300	14	2,200	1
1 6097 200 010	PH7-200A-10F		200	100	226	400	14	2,200	1
1 6097 200 015	PH7-200A-15F		200	150	226	600	14	2,200	1
1 6097 200 020	PH7-200A-20F		200	200	226	800	14	2,200	1
1 6097 200 030	PH7-200A-30F		200	300	226	1200	14	2,200	1

\* mit 14 Kettengliedern kpl vormontiert  
\* with 14 guide links pre-assembled

Weitere Breiten auf Anfrage  
Further widths on request

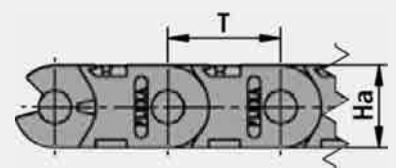
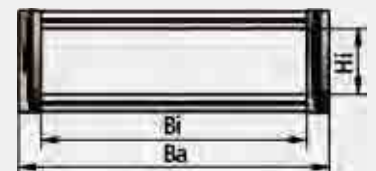

🌡️ -40°C ... +135°C

## PH10

### TECHNISCHE DATEN

### TECHNICAL DATA

<b>Bi</b>	Innenbreite	Inner width
<b>Ba</b>	Außenbreite	Outer width
<b>BL</b>	Bogenlänge	Bow length
<b>H</b>	Bauhöhe	Total height
<b>Ha</b>	Außenhöhe	Outer height
<b>Hi</b>	Innenhöhe	Inner height
<b>L</b>	Verfahrweg	Travel length
<b>O</b>	Öffnungsweite	Opening
<b>R</b>	Radius	Radius
<b>T</b>	Teilung	Pitch
<b>TS</b>	Trennsteg	Separator



VIDEO



Innenhöhe	Hi	Inner height	49 mm
Außenhöhe	Ha	Outer height	77 mm
Kettenglieder montiert/m		Chain links assembled / meter	10
Teilung	T	Pitch	100 mm
Kettenlänge		Guide chain length	ca.   appr. L/2 + BL
Bauhöhe	H	Total height	ca.   appr. 2 x R + Ha
Freitragende Länge		Free carrying length	max. 4600 mm
Verfahrweg Standard	L	Travel standard	max. 50 m
Verfahrweg in Rinne		Travel in channel	max. 100 m
Zusatzgewicht		Load	max. 35 kg/m
Geschwindigkeit		Speed	max. 10 m/sec
Beschleunigung		Acceleration	max. 15 m/sec <sup>2</sup>
Zugbelastbarkeit		Tensile strength	max. 2200 N
Trennstegdicke		Separator thickness	4 mm

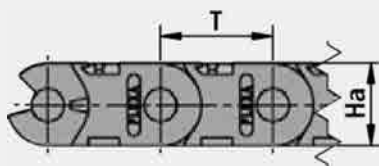
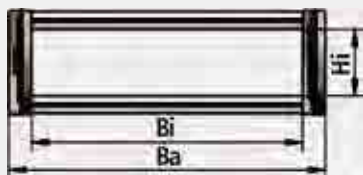
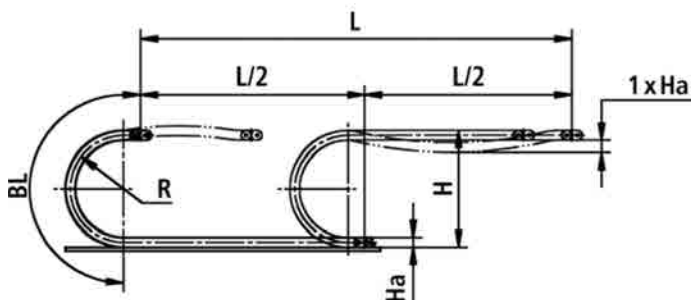

FLEXA No.

Artikel  
article



schwarz black		Bi mm	R mm	Ba mm	BL mm	St.   pcs. max.	kg m	m*
1 6091 075 010	PH10-75A-10F	75	100	109	400	4	2,970	1
1 6091 075 015	PH10-75A-15F	75	150	109	600	4	2,970	1
1 6091 075 020	PH10-75A-20F	75	200	109	800	4	2,970	1
1 6091 075 030	PH10-75A-30F	75	300	109	1200	4	2,970	1
1 6091 100 010	PH10-100A-10F	100	100	134	400	5	3,110	1
1 6091 100 015	PH10-100A-15F	100	150	134	600	5	3,110	1
1 6091 100 020	PH10-100A-20F	100	200	134	800	5	3,110	1
1 6091 100 030	PH10-100A-30F	100	300	134	1200	5	3,110	1
1 6091 150 010	PH10-150A-10F	150	100	184	400	8	3,390	1
1 6091 150 015	PH10-150A-15F	150	150	184	600	8	3,390	1
1 6091 150 020	PH10-150A-20F	150	200	184	800	8	3,390	1
1 6091 150 030	PH10-150A-30F	150	300	184	1200	8	3,390	1
1 6091 200 010	PH10-200A-10F	200	100	234	400	11	3,670	1
1 6091 200 015	PH10-200A-15F	200	150	234	600	11	3,670	1
1 6091 200 020	PH10-200A-20F	200	200	234	800	11	3,670	1
1 6091 200 030	PH10-200A-30F	200	300	234	1200	11	3,670	1
1 6091 250 010	PH10-250A-10F	250	100	284	400	13	3,950	1
1 6091 250 015	PH10-250A-15F	250	150	284	600	13	3,950	1
1 6091 250 020	PH10-250A-20F	250	200	284	800	13	3,950	1
1 6091 250 030	PH10-250A-30F	250	300	284	1200	13	3,950	1
1 6091 300 010	PH10-300A-10F	300	100	334	400	16	4,230	1
1 6091 300 015	PH10-300A-15F	300	150	334	600	16	4,230	1
1 6091 300 020	PH10-300A-20F	300	200	334	800	16	4,230	1
1 6091 300 030	PH10-300A-30F	300	300	334	1200	16	4,230	1

\* mit 10 Kettengliedern kpl. vormontiert  
\* with 10 guide links pre-assembled

Weitere Breiten auf Anfrage  
Further widths on request

# PH12

-40°C ... +135°C

## TECHNISCHE DATEN

## TECHNICAL DATA

Innenhöhe	Hi	Inner height		80 mm
Außenhöhe	Ha	Outer height		108 mm
Kettenglieder montiert/m		Chain links assembled / meter		8
Teilung	T	Pitch		125 mm
Kettenlänge		Guide chain length	ca.   appr.	L/2 + BL
Bauhöhe	H	Total height	ca.   appr.	2 x R + Ha
Freitragende Länge		Free carrying length	max.	6600 mm
Verfahrweg Standard	L	Travel standard	max.	75 m
Verfahrweg in Rinne		Travel in channel	max.	120 m
Zusatzgewicht		Load	max.	80 kg/m
Geschwindigkeit		Speed	max.	10 m/sec
Beschleunigung		Acceleration	max.	15 m/sec <sup>2</sup>
Zugbelastbarkeit		Tensile strength	max.	4300 N
Trennstegdicke		Separator thickness		4 mm

Bi	Innenbreite	Inner width
Ba	Außenbreite	Outer width
BL	Bogenlänge	Bow length
H	Bauhöhe	Total height
Ha	Außenhöhe	Outer height
Hi	Innenhöhe	Inner height
L	Verfahrweg	Travel length
O	Öffnungsbreite	Opening
R	Radius	Radius
T	Teilung	Pitch
TS	Trennstege	Separators



VIDEO

### FLEXA No.

 Artikel  
article

schwarz black		Bi mm	R mm	Ba mm	BL mm	St.   pcs. max.	kg/m	m*
1 6096 100 015	PH12-100A-15F	100	150	142	600	5	4,880	1
1 6096 100 020	PH12-100A-20F	100	200	142	800	5	4,880	1
1 6096 100 025	PH12-100A-25F	100	250	142	1000	5	4,880	1
1 6096 100 030	PH12-100A-30F	100	300	142	1200	5	4,880	1
1 6096 100 050	PH12-100A-50F	100	500	142	2000	5	4,880	1
1 6096 150 015	PH12-150A-15F	150	150	192	600	8	5,110	1
1 6096 150 020	PH12-150A-20F	150	200	192	800	8	5,110	1
1 6096 150 025	PH12-150A-25F	150	250	192	1000	8	5,110	1
1 6096 150 030	PH12-150A-30F	150	300	192	1200	8	5,110	1
1 6096 150 050	PH12-150A-50F	150	500	192	2000	8	5,110	1
1 6096 200 015	PH12-200A-15F	200	150	242	600	11	5,330	1
1 6096 200 020	PH12-200A-20F	200	200	242	800	11	5,330	1
1 6096 200 025	PH12-200A-25F	200	250	242	1000	11	5,330	1
1 6096 200 030	PH12-200A-30F	200	300	242	1200	11	5,330	1
1 6096 200 050	PH12-200A-50F	200	500	242	2000	11	5,330	1
1 6096 250 015	PH12-250A-15F	250	150	292	600	13	5,560	1
1 6096 250 020	PH12-250A-20F	250	200	292	800	13	5,560	1
1 6096 250 025	PH12-250A-25F	250	250	292	1000	13	5,560	1
1 6096 250 030	PH12-250A-30F	250	300	292	1200	13	5,560	1
1 6096 250 050	PH12-250A-50F	250	500	292	2000	13	5,560	1
1 6096 300 015	PH12-300A-15F	300	150	342	600	16	5,780	1
1 6096 300 020	PH12-300A-20F	300	200	342	800	16	5,780	1
1 6096 300 025	PH12-300A-25F	300	250	342	1000	16	5,780	1
1 6096 300 030	PH12-300A-30F	300	300	342	1200	16	5,780	1
1 6096 300 050	PH12-300A-50F	300	500	342	2000	16	5,780	1
1 6096 350 015	PH12-350A-15F	350	150	392	600	19	6,000	1
1 6096 350 020	PH12-350A-20F	350	200	392	800	19	6,000	1
1 6096 350 025	PH12-350A-25F	350	250	392	1000	19	6,000	1
1 6096 350 030	PH12-350A-30F	350	300	392	1200	19	6,000	1
1 6096 350 050	PH12-350A-50F	350	500	392	2000	19	6,000	1

\* mit 8 Kettengliedern kpl. vormontiert  
\* with 8 guide links pre-assembled

Weitere Breiten auf Anfrage  
Further widths on request

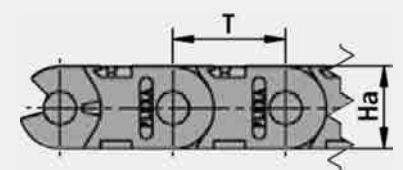
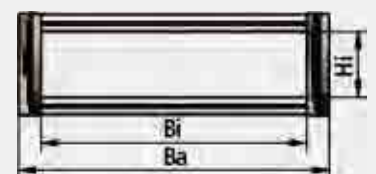

## ANSCHLÜSSE UND ZUBEHÖR

### CONNECTION PARTS

- einfache Montage
- hohe Stabilität
- integrierbare Zugentlastung
- dreiseitige Anschlussmöglichkeit
- easy to mount
- highly stable
- prepared for additional integrated strain relief system
- mountable on three sides



**Lagensteg LP**  
separiert die Leitungen in der Höhe  
LP layer stay  
separates the cables in the height

**Trennsteg PS**  
zum Trennen der Leitungen innerhalb der Kette  
PS separator  
conductors will be separated with push-in separators

**Standardanschluss PB**  
zum Anschluss und zur Befestigung der Führungskette PH  
PB standard connector for connection and fixation of the PH guide chain

**Zugentlastungsschiene SCSRN**  
Modul zur Zugentlastung  
SCSRN strain relief bar for strain relief purposes

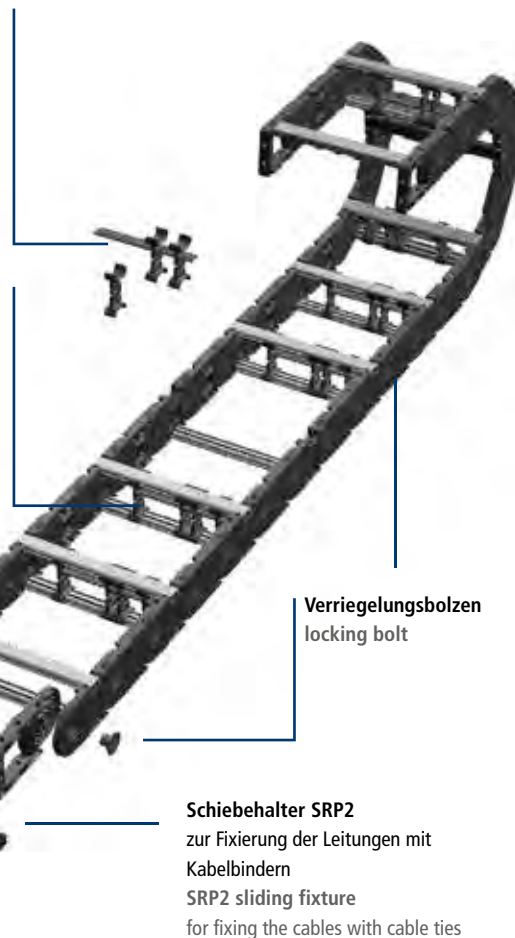

## PS

Trennsteg PS

### MATERIAL

Kunststoff PA6 GFK

### EIGENSCHAFTEN

- zum Trennen der Leitungen innerhalb der Kette
- nachträglich montierbar
- optimal in jedem zweiten Kettenglied

PS separator

### MATERIAL

PA6 GFK plastics

### PROPERTIES

- conductors are separated with push-in separators
- also applicable for subsequent installation
- best applied in every second chain link

FLEXA No.	Artikel article	Typ type	Breite width	St. pcs.
schwarz black			mm	
1 6327 000 000	PS7-PH	PH7	4,0	25
1 6321 000 000	PS10-PH	PH10	4,0	25
1 6326 000 000	PS12-PH	PH12	4,0	25

# LP

Lagensteg LP

LP layer stay

## MATERIAL

Kunststoff PA6 GFK

## MATERIAL

PA6 GFK plastics

## EIGENSCHAFTEN

- separiert die Leitungen in der Höhe
- nachträglich in die Trennsteg PS montierbar
- in unterschiedlichen Höhen montierbar

## PROPERTIES

- separates the cables in the height
- can be installed subsequently in the PS separators
- can be mounted in various heights

## ANSCHLÜSSE UND ZUBEHÖR

### CONNECTION PARTS



FLEXA No.	Artikel article	Typ type	Breite width	Länge length	
schwarz black			mm	mm	St. pcs.
1 6316 000 009	LP150	PH7 10 12	4,0	153,0	10

# PB

Standardanschluss PB

PB standard connector

## MATERIAL

Kunststoff PA6 GFK

## MATERIAL

PA6 GFK plastics

## EIGENSCHAFTEN

- zum Anschluss und Befestigung der Führungsketten PH
- Set bestehend aus zwei Anschlussteilen
- zur Aufnahme der Zugentlastungsschiene SCSRN

## PROPERTIES

- for connection and fixation of the PH guide chains
- set includes two connecting parts
- to be combined with SCSRN strain relief module

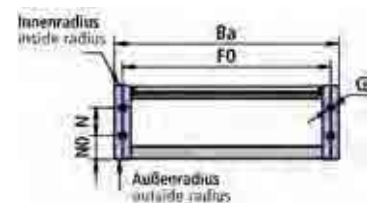

FLEXA No.	Artikel article	Typ type	F mm	FO mm	G mm	N mm	NO mm	S mm	U mm	St. pcs.
schwarz black										
1 6157 000 009	PB7-PH	PH7	Bi + 13	Bi + 13	5,5	22,0	16,0	41,5	64,0	1
1 6151 000 009	PB10-PH	PH10	Bi + 17	Bi + 17	6,5	29,0	25,0	62,0	97,0	1
1 6156 000 009	PB12-PH	PH12	Bi + 21	Bi + 21	10,5	46,0	32,0	83,0	118,0	1

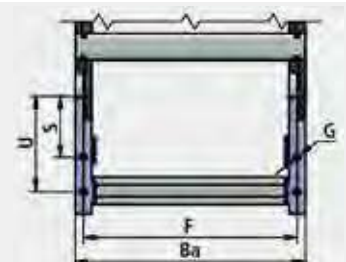

## ANSCHLÜSSE UND ZUBEHÖR

### CONNECTION PARTS

# SCSRN | SRP2 | PH-G

Zugentlastungsschiene SCSRN

SCSRN strain relief bar

**MATERIAL** Stahl verzinkt

**MATERIAL** galvanized steel

- für schwere Anwendungen
- zur Montage in den Standardanschluss PB

- for heavy-duty applications
- for mounting to PB standard connector

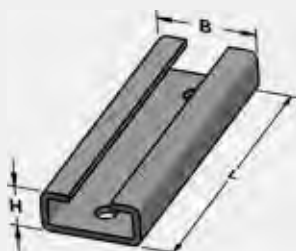

FLEXA No.	Artikel article	Typ type	C-Profil c-profile	Länge length			St. pcs.
schwarz black				H mm	B mm	L mm	
1 6277 050 000	SCSRN7-50	PH 7	11	10,0	25,0	50,0	1
1 6277 065 000	SCSRN7-65	PH 7	11	10,0	25,0	65,0	1
1 6277 100 000	SCSRN7-100	PH 7	11	10,0	25,0	100,0	1
1 6277 150 000	SCSRN7-150	PH 7	11	10,0	25,0	150,0	1
1 6277 200 000	SCSRN7-200	PH 7	11	10,0	25,0	200,0	1
1 6271 075 000	SCSRN10-75	PH 10 12	12	12,0	28,0	75,0	1
1 6271 100 000	SCSRN10-100	PH 10 12	12	12,0	28,0	100,0	1
1 6271 150 000	SCSRN10-150	PH 10 12	12	12,0	28,0	150,0	1
1 6271 200 000	SCSRN10-200	PH 10 12	12	12,0	28,0	200,0	1
1 6271 250 000	SCSRN10-250	PH 10 12	12	12,0	28,0	250,0	1
1 6271 300 000	SCSRN10-300	PH 10 12	12	12,0	28,0	300,0	1
1 6271 350 000	SCSRN10-350	PH 10 12	12	12,0	28,0	350,0	1

Schiebehalter SRP2

SRP2 sliding fixture

**MATERIAL** Kunststoff PA6 GFK

**MATERIAL** PA6 GFK plastics

- für Fixierung der Leitungen mit Kabelbindern
- frei in der Zugentlastungsschiene SCSRN positionierbar

- for fixing the cables with cable ties
- free positioning on SCSRN rail



FLEXA No.	Artikel article	Typ type	C-Profil c-profile	St. pcs.
schwarz black				
1 6170 000 003	SRP2-7	PH 7	11	25
1 6170 000 002	SRP2-10	PH 10 12	12	25

Gleiter PH-G

PH-G glider

**MATERIAL** Kunststoff PA6 GFK

**MATERIAL** PA6 GFK plastics

- für lange Verfahrswege
- für massive Anwendungen
- an jedem Kettenglied im Innenradius mit 2 Schrauben montierbar

- for long travel distances
- for heavy-duty applications
- can be mounted to each link plate into the holes of the frame stays with 2 screws at the inside radius



FLEXA No.	Artikel article	Typ type	Gleiter  glider m	St. pcs.
schwarz black				
1 6407 000 000	PH7-G	PH7	28	25
1 6405 000 000	PH10-G	PH10	20	25
1 6406 000 000	PH12-G	PH12	16	25

# PH

## MONTAGE DER TRENNSTEGE

Trennstege auf die vormontierten Alustege von oben schwenkend aufchieben bis sie einrasten. Dabei ist zu beachten, dass die Pfeile auf den Trennstegen alle nach „oben“ und in die gleiche Richtung zeigen!

## MOUNTING THE SEPARATORS

Push the separators onto the aluminium bars until they lock in completely. The arrows on the separators have to be aligned upwards and have to show in the same direction.

## MONTAGEHINWEISE ASSEMBLY INSTRUCTIONS



## MONTAGE DER LAGENSTEGE

Nachdem alle Trenn- und Alustege montiert sind, können die Lagenstege in die vorgesehenen Raststufen eingeschoben werden bis sie einrasten! (Trennstege sind dabei an ihre endgültige Positionen zu schieben).

## MOUNTING THE LAYER STAYS

After the separators and the aluminium bars have been mounted, the layer stays can be locked into the appropriate screens. (Push the separators into their final positions).



## MONTAGE DER ZUGENTLASTUNG

Die Zugentlastungsschiene wird zwischen den Anschlusslaschen PB[7|10|12] auf die vorgesehenen Vorsprünge fixiert (C-Schiene vor dem Fixieren mit Schieberhaltern SRP2 bestücken).

## MOUNTING THE STRAIN RELIEF

Position the SRP2 push holder on the SCSRN strain relief profile and jam the strain relief between two PB[7|10|12] connection parts by using the special noses.



## MONTAGE DER GLEITER

Bei langen Verfahrwegen können Gleiter an jedem Kettenglied (in Alusteg bzw. geschlossene Lasche) mit 2 Schrauben (im Lieferumfang) befestigt. Bei Standardlieferungen sind die Gleiter bereits im Innenradius montiert.

## MOUNTING THE GLIDERS

For long travel distances gliders can be screwed on each link plate into the holes of the frame stays and also directly into the holes of the link plate. The screws are included in the delivery. For standard deliveries, the gliders have already been mounted at the inner radius.



## MONTAGEHINWEISE

### ASSEMBLY INSTRUCTIONS

# PH

## KÜRZEN | VERLÄNGERN

Laschenbänder auf die gewünschte Länge montieren, Verriegelungsbolzen bis zum Anschlag einsetzen und im Uhrzeigersinn verriegeln.

## LENGTHEN | SHORTEN

Mount the link plates up to the desired length and screw in the locking bolts. Lock the bolts by turning them clockwise.

## MONTAGE | DEMONTAGE DER ALUMINIUM-RAHMENSTEGE

Laschenbänder am Anfang und am Ende jeweils mit einem Rahmensteg fixieren. Anschließend die restlichen Stege nach Einlegen der Leitungen und Schläuche einbauen. Der Steg sitzt nach zweimaligem Klicken.

## ASSEMBLY AND DISASSEMBLY OF THE ALUMINIUM FRAME BARS

Begin with the installation of the first and the last frame bar to stabilize the system. Then mount the remaining bars. The bars must click twice for perfect positioning and secure locking.

Die Demontage erfolgt durch Herausdrehen des Rahmenstegs mit Hilfe eines Schraubenschlüssels.

If you wish to remove the frame bar, please use a spanner.

## RAHMENSTEGE AUS ALUMINIUM

Bei Standardlieferungen bereits im Außenradius montiert.

Zuerst einseitig in die Stegaufnahme der Laschen bis zum Anschlag einschieben und dann mit einem Kunststoffhammer in die Aufnahme einklopfen.

## FRAME BARS MADE OF ALUMINIUM

Accommodation of the link plate until it settles at the stop.

Then use a plastic hammer for final fixing (the stay has two pawls). For standard deliveries, the stays are already mounted at the outside radius.





## ARAW

### Rinnensystem

Einfach, flexibel zu montieren, bietet eine professionelle Optik.

Bei längeren Verfahrwegen, hohen Verfahrgeschwindigkeiten oder geringen Kettenbreiten ist der Einsatz von Rinnensystemen sinnvoll bzw. notwendig. Sie verhindern das Umkippen der Führungskette und ein seitliches Ausweichen.

### MATERIAL

Aluminium

### EIGENSCHAFTEN

- blitzschnelle und versatzfreie Montage
- Befestigungsplatte kann innen bzw. außen befestigt werden
- passende Alu-Rinnenprofile für Führungsketten PL und PH
- seewasserbeständige und korrosionsfeste Rinnenprofile
- erweiterbar

### LIEFERLÄNGEN

Lieferung bis zu 3 m-Stücken  
Befestigungsschrauben sind nicht im Lieferumfang enthalten.

### VARIABLE IN HÖHE UND BREITE

Die Aluminiumrinne kann in der Höhe durch das Aufsatzprofil mehrfach aufgestockt werden. Ebenso ist die Rinnenbreite mit geringem Aufwand veränderbar. Wir empfehlen die Verwendung von Abstandshaltern aus einfachem Baumaterial. In der Längsrichtung wird durch den Zentrierstift eine versatzfreie und schnelle Montage erreicht. Das Ausrichten des Rinnensystems kann mittels Schlagschnur oder Laser parallel zur Verfahrrichtung des beweglichen Mitnehmers erfolgen.

### BEFESTIGUNGSPLATTE

vorfixieren. Wahlweise kann diese von innen oder außen angebracht werden. Bei schweren Anwendungen innen und außen montieren. In der Längsrichtung ist die Befestigungsplatte verschiebbar. Empfohlener Abstand ca. 1.000 mm. Befestigungsplatte mit Senkkopfschraube M8 nach DIN 7991 befestigen [Drehmoment 4,50 Nm].

### Channel system

Easy and flexible to install, revealing a professional visual effect.

A channel system can be useful or indispensable for extended travel distances, high travel speeds, high acceleration, or small guide chains with big radii. A channel system is to prevent the guide chain from overturning and from lateral deflection.

### MATERIAL

aluminium

### PROPERTIES

- quick mounting without displacement
- attachment link can be installed inside and outside
- the channel system fits both the PL and the PH guide chains
- resistant to seawater and corrosion
- extendible

### DELIVERY LENGTH

Delivery in sections up to 3 meter of length. Fixing screws are not included in delivery.

### VARIABLE IN HEIGHT AND WIDTH

The aluminium guide channel can be raised by several top parts. Also the inside width of the channel system can be heightened very easily. We recommend the use of spacers made of simple construction material. The grooved pin ensures mounting without displacement in the grain direction. The alignment of the channel system can be practiced by chalk line or a laser. Please ensure alignment to be made in parallel to the travel direction of the movable carrier.

### PREFASTEN ATTACHMENT LINK

The link can be attached either inside or outside the channel system. For heavy-duty applications mount the link to the inside and to the outside. In the grain direction the attachment link is slideable. Recommended distance: 1,000 mm. Fix attachment link with M8 countersunk screw according to DIN 7991 [4.50 Nm of torque].

## RINNENSYSTEM ARAW

### ARAW CHANNEL SYSTEM

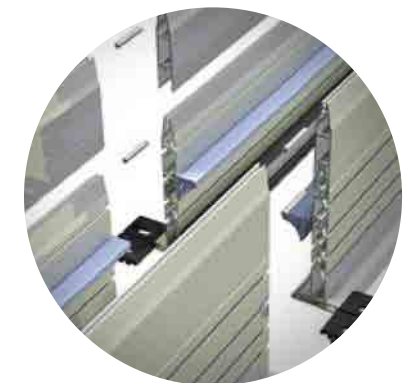

Verlängern der Rinne  
Lengthening the channel

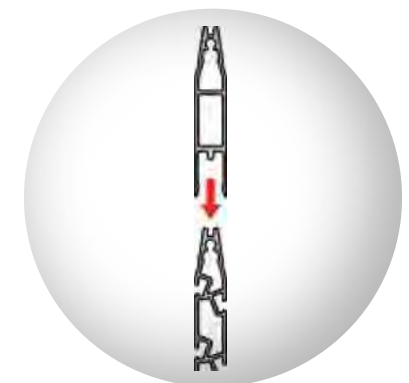

Aufstocken der Rinne  
Extending the system

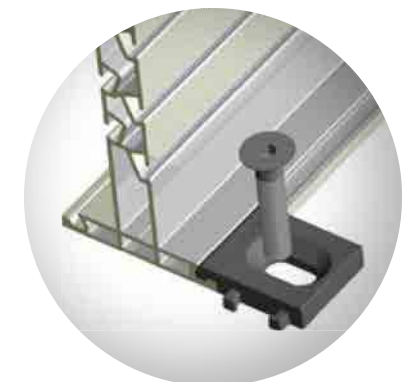

Befestigungsplatte montieren  
Fixing the attachment link

## RINNENSYSTEM ARAW ARAW CHANNEL SYSTEM

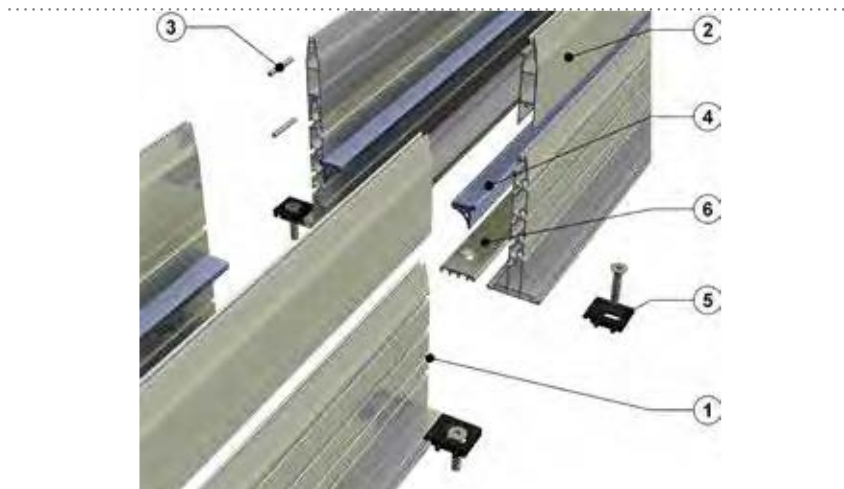

- |                                                                                   |                                                                               |
|-----------------------------------------------------------------------------------|-------------------------------------------------------------------------------|
| 1. Führungsrinne ARAW15 aus Aluminium<br>Länge 3000 mm, inkl. Befestigungsplatten | 1. ARAW15 aluminium guide channel<br>length of 3000 mm, mounting plates incl. |
| 2. Aufsatzprofil ARAW15-A für Aluminiumrinne                                      | 2. ARAW15-A top part for guide channel                                        |
| 3. Zentrierstift Stahl SKS 5x25<br>(im Lieferumfang enthalten)                    | 3. SKS 5x25 grooved pin<br>(included in delivery)                             |
| 4. Gleitleiste ARAW15-G aus Spezialkunststoff                                     | 4. ARAW15-G slide bar made of special plastic                                 |
| 5. Befestigungsplatte ARKP   2 Stück m                                            | 5. ARKP mounting plate   2 units meter                                        |
| 6. Verbreiterungsschiene ARAW15-V                                                 | 6. ARAW15-V widening profile                                                  |

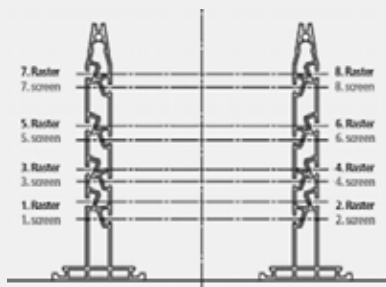

Typ type	Radius	ab Verfahrweg longer than travel distance	Rinne channel	Aufsatzprofil top part	Befestigungs- platte mounting plate	Gesamthöhe total height	Raster   Position screen   position
	mm	m				mm	
PL4	50	2,30	ARAW15		ARKP	153,0	1
	75	2,30	ARAW15		ARKP	153,0	1
	100	2,30	ARAW15		ARKP	153,0	1
	150	2,30	ARAW15		ARKP	153,0	1
	200	2,30	ARAW15		ARKP	153,0	1
PL5	60	3,10	ARAW15		ARKP	153,0	2
	100	3,10	ARAW15		ARKP	153,0	2
	125	3,10	ARAW15		ARKP	153,0	2
	150	3,10	ARAW15		ARKP	153,0	2
	200	3,10	ARAW15	ARAW15-A	ARKP	214,0	2
	250	3,10	ARAW15	ARAW15-A	ARKP	214,0	2
PH7	75	3,50	ARAW15		ARKP	153,0	3
	100	3,50	ARAW15		ARKP	153,0	3
	150	3,50	ARAW15		ARKP	153,0	3
	200	3,50	ARAW15	ARAW15-A	ARKP	214,0	3
	300	3,50	ARAW15	2 x ARAW15-A	ARKP	275,0	3
PH10	100	4,60	ARAW15		ARKP	153,0	5
	150	4,60	ARAW15		ARKP	153,0	5
	200	4,60	ARAW15	ARAW15-A	ARKP	214,0	5
	300	4,60	ARAW15	2 x ARAW15-A	ARKP	275,0	5
PH12	150	6,60	ARAW15		ARKP	153,0	7
	200	6,60	ARAW15		ARKP	153,0	7
	250	6,60	ARAW15	ARAW15-A	ARKP	214,0	7
	300	6,60	ARAW15	2 x ARAW15-A	ARKP	275,0	7
	500	6,60	ARAW15	3 x ARAW15-A	ARKP	336,0	7

Zusatzgewicht reduziert die freitragende Länge  
Additional weight will reduce the free carrying length

# ARAW

Führungsrinne ARAW15

**MATERIAL** Aluminium

- für Führungsketten PL und PH
- schnelle und versatzfreie Montage
- Befestigungsplatte kann innen und außen befestigt werden
- seewasserbeständige und korrosionsfeste Rinnenprofile
- erweiterbar durch Fixierstifte
- Sonderlängen auf Anfrage
- ab 3 m Länge Zentrierstifte zur Verlängerung inklusive

ARAW15 guide channel

**MATERIAL** aluminium

- for PL and PH guide chains
- fast and perfectly aligned assembly
- mounting plate can be mounted both inside and outside
- gutter profiles resistant to sea water and to corrosion
- expandable with fixing pins
- special lengths available on request
- for lengths longer than 3 meter pins to extend the profiles are included

## RINNENSYSTEM ARAW

### ARAW CHANNEL SYSTEM



FLEXA No.	Artikel article	Typ type	Höhe height mm	Länge length mm	St. pcs.
1 6127 150 000	ARAW15	PL PH	153	3000	1

Aufsatzprofil ARAW15-A

**MATERIAL** Aluminium

- für Führungsketten PL und PH
- einfaches Aufstecken auf die Führungsschiene ARAW15
- Sonderlängen auf Anfrage
- ab 3 m Zentrierstifte zur Verlängerung inklusive

ARAW15-A top part

**MATERIAL** aluminium

- for PL and PH guide chains
- easy mounting to the ARAW15 guide channel
- special lengths available on request
- for lengths longer than 3 meter pins to extend the profiles are included

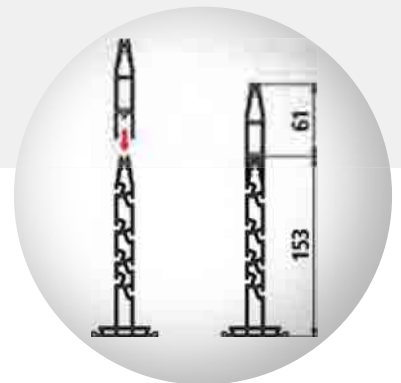

FLEXA No.	Artikel article	Typ type	Höhe height mm	Länge length mm	St. pcs.
1 6127 150 002	ARAW15-A	PL PH	61	3000	1

Verbreiterungsschiene ARAW15-V

**MATERIAL** Aluminium

- für die massive Installation der Führungsketten PH10 | PH12
- stabilisiert die Führungsschiene ARAW15
- ohne Befestigungsbohrungen (kundenseitig)

ARAW15-V widening profile

**MATERIAL** aluminium

- for heavy-duty installations of PH10 | PH12 guide chains
- stabilizes the ARAW15 guide channel
- without mounting bores (customer)

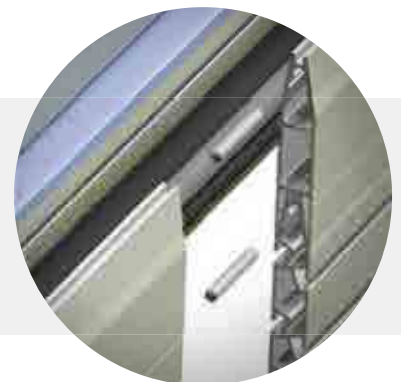

FLEXA No.	Artikel article	Typ type	Länge length mm	St. pcs.
1 127 150 003	ARAW15-V	PL PH	3000	1

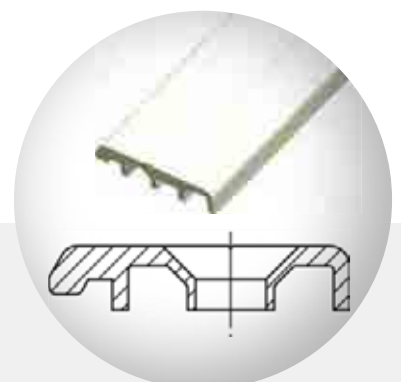

RINNENSYSTEM ARAW  
ARAW CHANNEL SYSTEM

# ARAW15-G

Gleitleiste ARAW15-G

ARAW15-G slide bar

**MATERIAL**

Kunststoff modifiziert

**MATERIAL**

plastics modified

**EIGENSCHAFTEN**

- für Führungsketten PL und PH
- verbessert die Gleiteigenschaften bei langen Verfahrwegen
- einfach in die Führungsschiene ARAW15 einschieben
- inklusive Fixierungsschraube

**PROPERTIES**

- for PL and PH guide chains
- improves the sliding properties over long travel distances
- simply insert into the ARAW15 guide rail
- fixing screw included in delivery

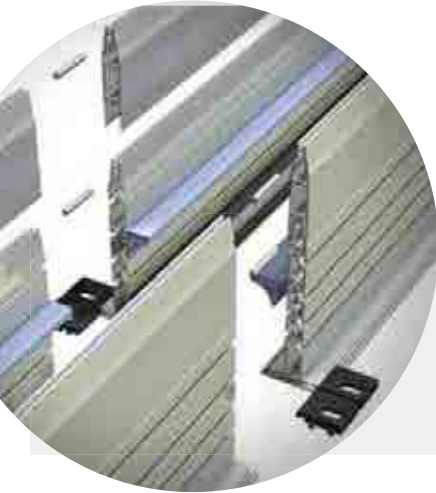

FLEXA No.	Artikel article	Typ type	Länge length	
blau blue			mm	St. pcs.
1 6127 150 001	ARAW15-G	PL PH	3000	1

# ARKP

Befestigungsplatte ARKP

ARKP mounting plate

**MATERIAL**

Kunststoff PC

**MATERIAL**

PC plastics

**EIGENSCHAFTEN**

- zur Befestigung der Führungsrinne ARAW15
- optimal mit M8 Senkkopfschraube zu befestigen
- Empfehlung: Befestigungsabstand 1 m

**PROPERTIES**

- to fix the ARAW15 guide channel
- optimal mounting with M8 countersunk screw
- recommendation: fixing distance of 1 meter

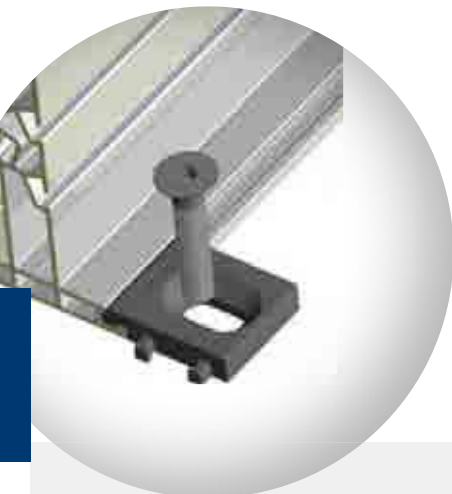

FLEXA No.	Artikel article	Typ type	ARKP   m	
			St. m pcs. meter	St. pcs.
1 6129 150 000	ARKP	PL PH	2	10

AUSWAHL DER FÜHRUNGSKETTE

SELECTING THE GUIDE CHAIN

1. FESTLEGEN DER KETTENABMESSUNG | BEFÜLLUNG

Bestimmung eines passenden Kettenquerschnitts unter Berücksichtigung der zu verlegenden Leitungen und Befüllungshinweise.

2. BESTIMMUNG DES BIEGERADIUS

Bestimmung des Biegeradius der Führungskette in Abhängigkeit des Leitungsdurchmessers. Hierbei bitte auch Angaben der Leitungshersteller beachten.

Der Biegeradius R wird anhand des Faktors f in Abhängigkeit des größten Außendurchmessers D vorhandener Leitungen festgelegt.

Übliche Faktoren [f] von Leitungen für Führungsketten liegen zwischen 5 und 10 x D. Bitte die Angaben der Kabelhersteller beachten!

$$R = f \times D$$

Beispiel:

größtes Kabel: D = 18 mm  
 Ergebnis: 10 x 18 = 180 mm  
 → R = 200 mm

3. BESTIMMUNG DES ZUSATZGEWICHTS

Das Zusatzgewicht durch die Leitungen kann den Herstellerangaben entnommen werden.

4. AUSWAHL DER FÜHRUNGSKETTE

Wählen Sie den passenden Kettentyp aus unserem Katalog unter Berücksichtigung des Einsatzbereiches, der Größe und der Verfahrensgeschwindigkeit aus.

1. DIMENSIONING THE GUIDE CHAIN | THE CONTENT RESPECTIVELY

Determination of the right cross-section with regard to the wires, cables, and hoses to be laid.

2. DETERMINING THE BENDING RADIUS

Determination of the bending radius with regard to the outside diameter of wires, cables, and hoses. Please also refer to the manufacturer's specifications.

The bending radius R is determined through factor f against the largest outside diameter D of the wires applied.

Common factors [F] for wires for energy guide chains are between 5 and 10 x D. Please refer to the manufacturer's specifications!

$$R = f \times D$$

Example:

largest cable: D = 18 mm  
 result: 10 x 18 = 180 mm  
 → R = 200 mm

3. DETERMINING THE ADDITIONAL WEIGHT

The additional weight due to wires, cables, and hoses is listed in the manufacturer's specifications.

4. SELECTING THE GUIDE CHAIN

Choose the appropriate guide chain by considering the range, the size, and the travel speed. This information is provided in the "Properties" tables contained in our catalogue.

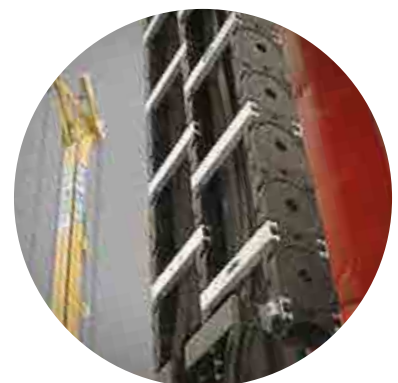
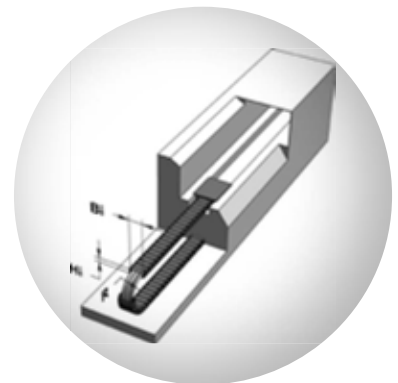
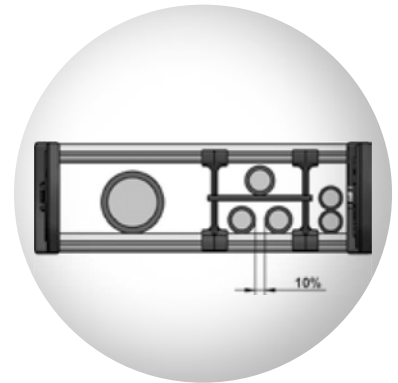

## AUSWAHL DER FÜHRUNGSKETTE

### SELECTING THE GUIDE CHAIN

### 5. BERECHNUNG DER FÜHRUNGSKETTENLÄNGE

### 5. CALCULATING THE LENGTH OF A GUIDE CHAIN



Festpunkt in der Mitte des Verfahrweges? Festpunkt außerhalb der Mitte des Verfahrweges?

Festanschluss der Führungskette in der Mitte des Verfahrweges L

$$LK = L/2 + BL$$

LK Führungskettenlänge  
BL Bogenlänge (4 x R)

Festanschluss außerhalb der Mitte des Verfahrweges L

$$LK = L/2 + BL + DL$$

DL Länge zwischen Anschlusspunkt und Mitte des Verfahrweges

Fixing point in the middle of the travel length? Fixing point not in the middle of the travel length?

Fixing point in the middle of the travel length L

$$LK = L/2 + BL$$

LK Guide chain length  
BL Bow length (4 x R)

Fixing point not in the middle of the travel length L

$$LK = L/2 + BL + DL$$

DL Length between fixing point and the middle of the travel length

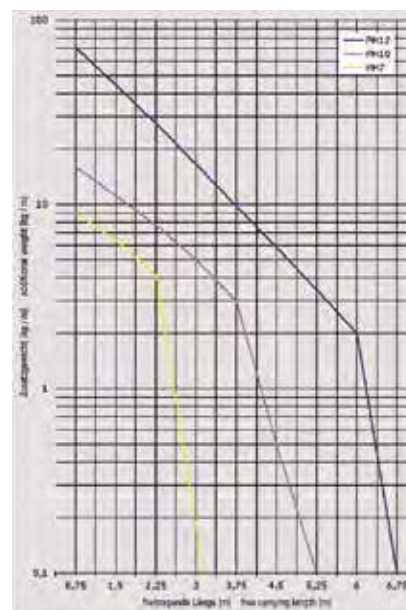
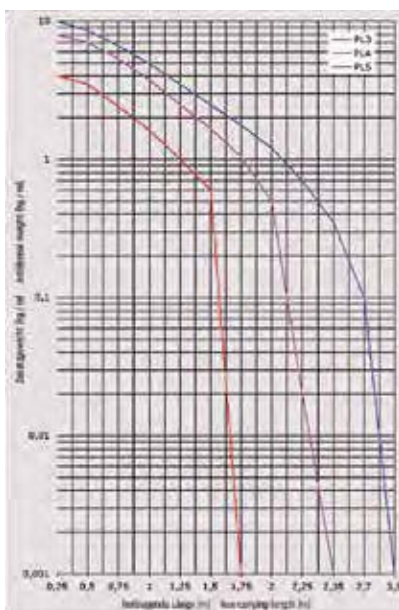
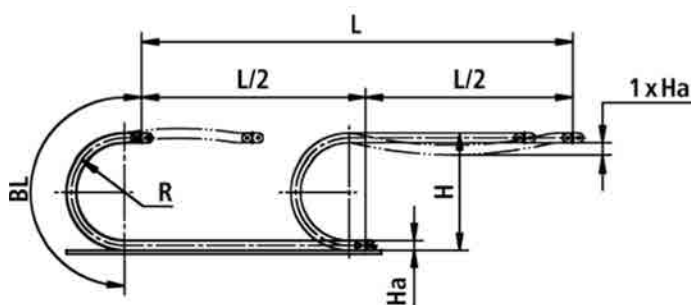
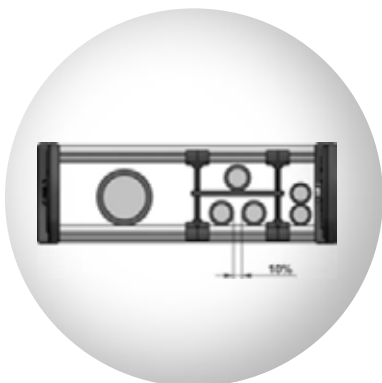
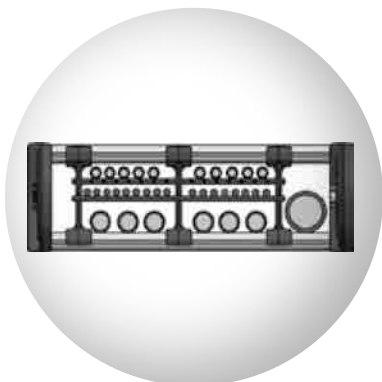
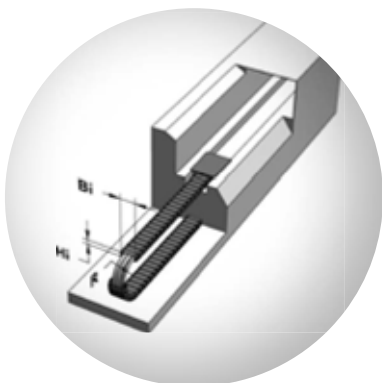

AUSWAHL DER FÜHRUNGSKETTE

SELECTING THE GUIDE CHAIN

6. BESTIMMUNG DER FREI-TRAGENDEN KETTENLÄNGE

Mit den ermittelten Zusatzgewichten der Kettenbelegung können Sie anhand der betreffenden Produkttabelle die freitragende Kettenlänge bestimmen.

7. ZUGENTLASTUNG DER LEITUNGEN

Kabel und Schläuche sollten an beiden Enden mindestens an einer Seite zugentlastet werden. Bei langen Fahrwegen über 30 m empfehlen wir Zugentlastungen auch innerhalb der Führungskette.

8. BEFÜLLUNG

Verwenden Sie grundsätzlich flexible Leitungen und Kabel! Kabel und Schläuche müssen sich frei zwischen Stegen bzw. Profilen bewegen können.

Es müssen folgende Richtwerte eingehalten werden:

bei Rundleitungen:

- + 10 % des Außendurchmessers bei Flachleitungen:
- + 10 % der Kabelbreite/-dicke bei Schlauchleitungen:
- + 20 % des Außendurchmessers

Bei Hydraulik- bzw. Luftdruckschläuchen wird der Freiraum gemäß den Herstellerangaben gewählt. Leitungen mit unterschiedlichen Leitungsdurchmessern getrennt führen.

Das Leitungsgewicht sollte symmetrisch auf der Breite der Kette verteilt werden.

Schwere Leitungen bevorzugt an den Außenwänden anordnen. Bei Leitungen und Kabeln mit unterschiedlichen Außenmänteln sollte auf die Gefahr des Verklebens untereinander geachtet werden. Gegebenenfalls Trennstege verwenden.

6. DETERMINING THE FREE CARRYING LENGTH

Please determine the free carrying length taking the additional weights of the wires, cables, and hoses into consideration by means of the product specification tables.

7. THE STRAIN RELIEF SYSTEM

Cables and hoses should be relieved on both ends of the chain, but at least on one side. If the travel length exceeds 30 meter, we recommend to relieve the cables also within the chain.

8. LOADING

Please always use flexible wires and cables! Cables and hoses must have enough space for free movement.

The following guidelines have to be met:

space for round cables:

- + 10% of outer diameter
- space for flat cables:
- + 10% of width/thickness
- space for conduits/hoses:
- + 20% of outside diameter

For hydraulic hoses and air hoses please follow manufacturer's specifications concerning space for movement. Cables with different diameters have to be laid separately.

The weight of the cables and hoses should be distributed symmetrical onto the guide chain.

Heavy-weight cables and hoses should be preferably laid close to the outer walls. Please make sure that the jackets of different wires and cables do not stick together. Use separators, if required.

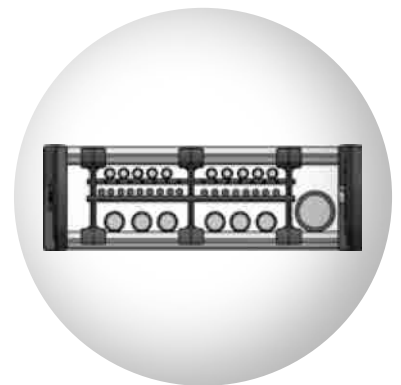
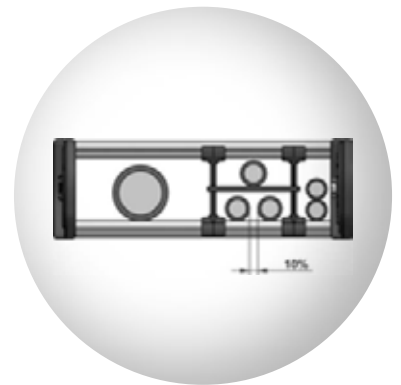
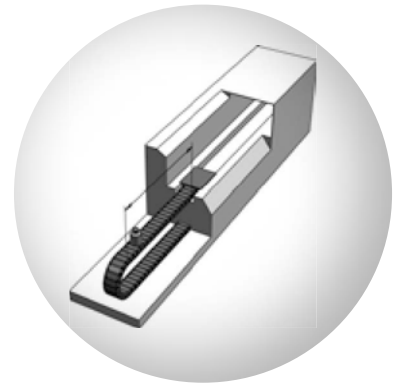

## MATERIALEIGENSCHAFTEN

### MATERIAL PROPERTIES

Chemische Eigenschaften der Kunststoffketten PL und PH  
Chemical properties of the PL and PH plastic guide chains

+ beständig    o bedingt beständig    - nicht beständig  
+ resistant    o conditionally resistant    - not resistant

Medium Medium	Konzentration Concentration Gew-%   mass-%	GF 35 Glasfaser 35% Glass fibre 35%
Aceton Acetone	100	+
Ameisensäure (wässrig) Formic acid (aqueous)	2	o
Ammoniak (wässrig) Amonia (aqueous)	10	+
Benzin Petrol	100	+
Benzol Benzene	100	+
Bitumen Bitumen	100	o
Borsäure (wässrig) Boric acid (aqueous)	10	+
Buttersäure Butter acid	100	o
Calciumchlorid (wässrig) Calcium chloride (aqueous)	Ges.w.L.	+
Chlorwasser Chlorine water	Ges.w.L.	o
Chromsäure (wässrig) Chrome acid (aqueous)	1	o
Dieselöl Diesel oil	100	+
Eisen II cyanid Iron II cyanide	30	o
Essigsäure Acetic acid	2	+
Farbe Colour		+
Fette, Speisefett Fett		+
Fluorkohlenwasserstoffe Fluorocarbon		+
Formaldehyd (wässrig) Formaldehyde (aqueous)	30	+
Hydrauliköle Hydraulic oil		o
Kalilauge Caustic potash	10	+

Medium Medium	Konzentration Concentration Gew-%   mass-%	GF 35 Glasfaser 35% Glass fibre 35%
Kaliumsulfat (wässrig) Potassium (sulfateaqueous)	100	+
Methylacetat Methyl acetate	100	+
Milch Milk	100	+
Mineralöl Mineral oil	100	+
Natriumcarbonat (wässrig) Sodium carbonate(aqueous)	50	+
Öl, Speiseöl Oil, culinary oil		+
Öl, Schmieröl Oil, Lubricating oil		+
Ölsäure Oil acid	100	+
Polyesterharze (mit Styrol) Polyester resins with Styrene)		+
Perchloräthylen Tetrachlorethylene	100	+
Parffinöl Paraffin oil		+
Propangas Propane gas		+
Quecksilber Mercury		+
Salzsäure Hydrochloric acid	pH2	o
Salzsäure Hydrochloric acid	2	o
Salzsäure Hydrochloric acid	10	-
Tinte, Farbe Ink, colour		+
Vaseline Vaseline		+
Weinsäure Tartaric acid		o
Zinksulfat (wässrig) Zinc sulfate (aqueous)	10	+



**MATERIALEIGENSCHAFTEN**  
**MATERIAL PROPERTIES**
**Mechanische Eigenschaften der Kunststoffketten PL und PH**  
 Mechanical properties of the PL and PH plastic guide chains

Eigenschaften Properties		Einheiten Units	Prüfmethode Testing method	Werte Values 35% Glasfaser 35% Glass fibre
Bruchspannung Breaking stress	5 mm/min	MPa	DIN EN ISO 527	110 * <sup>1</sup>
Bruchdehnung Elongation at break	5 mm/min	%	DIN EN ISO 527	4 * <sup>1</sup>
Elastizitätsmodul [Zugversuch] E modulus		MPa	DIN EN ISO 527	7,000 * <sup>1</sup>
Kerbschlagzähigkeit Impact strength	+23°C	kJ/m <sup>2</sup>	DIN EN ISO 179/1eU	21 * <sup>1</sup>
Kerbschlagzähigkeit Impact strength	-30°C	kJ/m <sup>2</sup>	DIN EN ISO 179/1eU	12 * <sup>1</sup>
Durchschlagsfestigkeit Disruptive strength		kV/mm	VDE 0303, TI.3	>80 * <sup>1</sup>
Spez. Oberflächenwiderstand spec. surface resistance			VDE-0303-3 DIN IEC 60093	10 12 * <sup>1</sup>
Dichte Density		g/cm <sup>3</sup>	DIN EN ISO 1183-1	1,39
Feuchtigkeitsaufnahme im NK 23/50 [Sättigung] Humidity absorption in NK 23/50 [saturation]		%	DIN EN ISO 62	1,9
Flammwidrigkeit Flammability		Klasse Class	UL 94 ISO 1210	94 HB * <sup>3</sup>
Brennverhalten nach VDE [Glühdrahtprüfung] * <sup>1</sup> Burning behaviour according to VDE [wire check]	10 mm	°C	VDE 0471-2 DIN EN 60695-2	650
Brennverhalten nach VDE [Glühdrahtprüfung] * <sup>1</sup> Burning behaviour according to VDE [wire check]	3,0 mm	°C	VDE 0471-2 DIN EN 60695-2	650
Formbeständigkeitstemperatur Max. temperature for dimensional stability	Af (1,80 Mpa)	°C	DIN EN ISO 75	210
Formbeständigkeitstemperatur Max. temperature for dimensional stability	Bf (0,45 Mpa)	°C	DIN EN ISO 75	210
Vicat-Erweichungstemperatur Vicat-softening temperature	A/50 (10N)	°C	DIN EN ISO 306	215
Vicat-Erweichungstemperatur Vicat-softening temperature	B/50 (50N)	°C	DIN EN ISO 306	215

# 11

## KABELDURCHFÜHRUNGSSYSTEME CABLE ENTRY SYSTEMS



### EINE NACHTRÄGLICHE MONTAGE UND BESTÜCKUNG DES SYSTEMS IST MÖGLICH

und macht es anpassungsfähig an alle Herausforderungen. Durch das teilbare System können fertig konfektionierte Stecker durch Wände geführt und abgedichtet werden.

Hohe Flexibilität in der Anwendung, da die Durchführung und Zugentlastung auch noch nach Fertigstellung der Installation problemlos angebracht werden kann.

### ADDITIONAL CABLES CAN BE INSERTED AT ANY TIME

Because the system allows you to modify the composition of the rubber modules to meet the needs of the immediate situation, the system can be used for a multitude of purposes.

Highly adaptable to all situations as the system can be assembled and mounted on-site after construction or other installation.



Schienenfahrzeugindustrie  
Railway Technology

**FFR-AL-UL-ATEX**

Klemmrahmen für Kabeldurchführung  
Nutm- und Federsystem  
Material Aluminium Vollmaterial  
Clamping frame for cable entry system  
specially designed tongue and  
groove system  
Material solid aluminium



11. 2

**FFR-PA**

Klemmrahmen für Kabeldurchführung  
Nutm- und Federsystem  
Material Kunststoff PA  
Clamping frame for cable entry system  
specially designed tongue and  
groove system  
Material PA plastics



11. 3

**FFKEP-PA**

Kabeldurchführungsplatte  
Material Elastomer  
Cable entry plate  
Material elastomer



11.10

**FFRR-TPE-V0**

Teilbare Ringraumdichtung  
Material Kunststoff PA, TPE  
Split press ring seal  
Material PA plastics, TPE

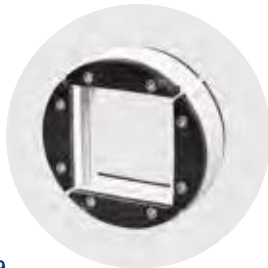

11. 9

**FFEK-TPE-V0**

Klemmeinsätze klein  
ATEX-Zulassung  
Material TPE  
Clamping inserts small  
ATEX certified  
Material TPE



11. 4

**FFEG-TPE-V0**

Klemmeinsätze groß  
ATEX-Zulassung  
Material TPE  
Clamping inserts large  
ATEX certified  
Material TPE



11. 5

**FFEK-TPE**

Klemmeinsätze klein  
Material TPE  
Clamping inserts small  
Material TPE



11. 6

**FFEG-TPE**

Klemmeinsätze groß  
Material TPE  
Clamping inserts large  
Material TPE



11. 7

**FFBS-PA-V0**

Blindstopfen für Klemmeinsätze  
Material Kunststoff PA 6  
Blind plugs for clamping inserts  
Material PA 6 plastics



11. 8



IP 65  
 -40°C ... +100°C

Zubehör	Accessories	Seite   page
	FFEK-TPE-V0	11.4
	FFEG-TPE-V0	11.5
	FFEK-TPE	11.6
	FFEG-TPE	11.7
	FFBS-PA-V0	11.8

## FFR-AL-UL-ATEX

Klemmrahmen für Kabeldurchführung  
 mit Zugentlastung  
 aus hochwertigem Vollmaterial  
 inkl. Flachdichtung und Schrauben

Clamping frame for cable entry  
 with strain-relief  
 made of high-quality solid aluminium,  
 incl. flat sealing and screws

### MATERIAL

Aluminium AlMgSi 0,5

### MATERIAL

AlMgSi 0,5 aluminium

### EIGENSCHAFTEN

- einfache, problemlose Bestückung durch Nut- und Federsystem
- höchstmögliche Flexibilität durch standardisierte Klemmeinsätze
- geringer Platzbedarf durch kompakte, sehr kleine Bauform
- hohe Flexibilität in der Anwendung, da die Durchführung und Zugentlastung auch nach Fertigstellung der Installation problemlos angebracht werden kann
- auch eine nachträgliche Montage oder Bestückung ist problemlos möglich
- höchster Korrosionsschutz

### PROPERTIES

- simple, trouble free assembly of clamping inserts through a specially designed tongue and groove system
- standardized clamping inserts make it highly adaptable to all situations
- compact design requires small space
- highly adaptable to all situations as the system can be assembled and mounted on-site after construction or other installation
- additional cables can be inserted into the system at any time
- highest corrosion protection

### ANWENDUNGSGEBIETE

- Anlagen-, Apparate- und Maschinenbau
- Mess- und Regeltechnik
- Antriebstechnik
- Mobile Studio- und Beleuchtungstechnik
- Windkraft- und Solarenergietechnik
- Elektroinstallation
- Schienenfahrzeuge

### APPLICATION

- plant, device and mechanical engineering
- measuring devices and controls
- drive engineering
- mobile studio and lighting technology
- wind power and solar energy technology
- electrical installation
- Railway industry

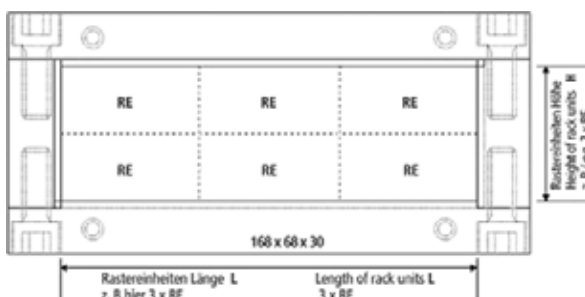

1 x Rastereinheit [RE] =  
 1 x Klemmeinsatz klein  
 2 x Rastereinheit [RE] =  
 1 x Klemmeinsatz groß

1 x rack unit =  
 1 x clamping insert small  
 2 x rack units high =  
 1 x clamping insert large



FLEXA No.	Raster Rack	Länge Length	Höhe Height	Tiefe Depth	kg St./pce.	Stück piece
	Einheit L x H Unit L x H	mm	mm	mm		
1 0380 110 202	2 x 2	108,0	68,0	30,0	0,426	1
1 0380 110 302	3 x 2	148,0	68,0	30,0	0,515	1
1 0380 110 303	3 x 3	148,0	88,0	30,0	0,540	1
1 0380 110 304	3 x 4	148,0	108,0	30,0	0,582	1
1 0380 110 402	4 x 2	188,0	78,0	30,0	0,779	1
1 0380 110 403	4 x 3	188,0	98,0	30,0	0,798	1
1 0380 110 404	4 x 4	188,0	118,0	30,0	0,880	1

# FFR-PA

Klemmrahmen für Kabeldurchführung mit Zugentlastung inkl. Flachdichtung und Schrauben

Clamping frame for cable entry with strain-relief incl. flat sealing and screws

IP 64  
-40°C ... +100°C

## MATERIAL

Kunststoff PA 6 GF50

## MATERIAL

PA 6 GF50 plastics

## EIGENSCHAFTEN

- HB [UL 94]
- einfache, problemlose Bestückung durch Nut- und Federsystem
- höchstmögliche Flexibilität durch standardisierte Klemmeinsätze
- geringer Platzbedarf durch kompakte, sehr kleine Bauform
- ein Rahmen für Durchführung und Zugentlastung
- Rahmen variabel einsetzbar
- auch eine nachträgliche Montage oder Bestückung ist problemlos möglich

## PROPERTIES



- HB [UL 94]
- simple, trouble free assembly of clamping inserts through a specially designed tongue and groove system
- standardized clamping inserts make it highly adaptable to all situations
- compact design requires little space
- one system for cable entry systems and strain-relief system
- all-purpose system
- additional cables can be inserted into the system at any time

## ANWENDUNGSGEBIETE

- Anlagen-, Apparate- und Maschinenbau
- Mess- und Regeltechnik
- Antriebstechnik
- Mobile Studio- und Beleuchtungstechnik
- Windkraft- und Solarenergietechnik
- Elektroinstallation

## APPLICATION

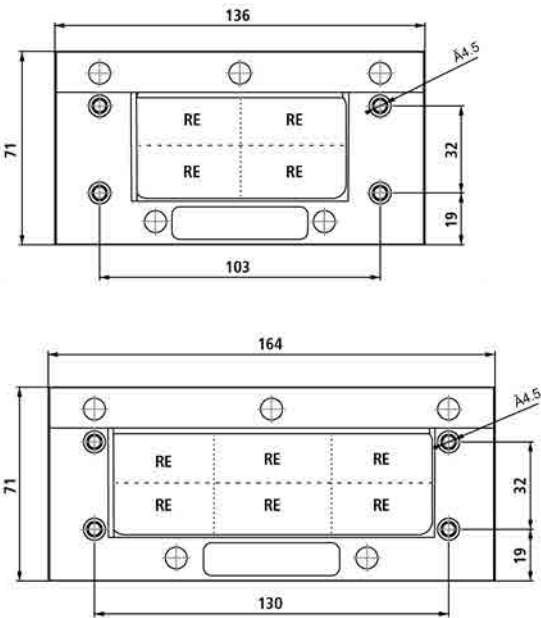

- plant, device and mechanical engineering
- measuring devices and controls
- drive engineering
- mobile studio and lighting technology
- wind power and solar energy technology
- electrical installation

Zubehör	Accessories	Seite   page
	FFEK-TPE	11.6
	FFEG-TPE	11.7
	FFBS-PA-V0	11.8



- 1 x Rastereinheit [RE] = 1 x Klemmeinsatz klein
- 2 x Rastereinheit [RE] = 1 x Klemmeinsatz groß
- 1 x rack unit = 1 x clamping insert small
- 2 x rack units high = 1 x clamping insert large



FLEXA No.	Raster Rack	Länge Length	Höhe Height	Tiefe Depth	 kg St./pce.	 Stück pieces
schwarz black	Einheit L x H Unit L x H	mm	mm	mm		
1 0380 102 202	2 x 2	136,0	71,0	30,0	0,306	3
1 0380 102 302	3 x 2	164,0	71,0	30,0	0,328	2



IP 65

-40°C ... +100°C

Zubehör Accessories

Seite | page



FFBS-PA-VO

11.8

## FFEK-TPE-VO | FFEK-TPE-VO-RAIL

Klemmeinsätze – klein  
Zum Einsetzen in die Klemmrahmen  
FFR-AL-UL-ATEX und in  
die Ringraumdichtung FFRR-TPE-VO

Clamping inserts – small  
For assembling in the clamping frames  
FFR-AL-UL-ATEX and in the  
press ring seal FFRR-TPE-VO

### MATERIAL

TPE halogenfrei, selbstverlöschend

### MATERIAL

TPE free of halogen, self-extinguishing

### EIGENSCHAFTEN

- VO [UL 94]
- einfache Bestückung der stabilen Rahmenkonstruktion durch Nut- und Federsystem, dadurch sind auch keine „Zwischenplatten“ notwendig
- erleichterte Kabel- oder Rohrdurchführung durch seitlichen Einführungsschlitz
- flammwidrig
- gute Beständigkeit gegen UV-Strahlung, Ozon, Säuren, Laugen, Kraftstoff, Lösungsmittel und Seewasser
- sehr gute Witterungsbeständigkeit

### PROPERTIES

- VO [UL 94]
- simple, trouble free assembly of clamping inserts through a specially designed tongue and groove system eliminating the need for extra metal holders within the frame
- cable passes easily through the lateral slit in each clamping insert
- flame resistant
- resistant to UV radiation, ozone, acid, leach, petroleum, solvent, sea water
- corrosion resistant

### TIPP

Nicht verwendete Öffnungen können mit Klemmeinsätzen aus Vollmaterial gefüllt, nicht benötigte Durchführungen können mit Blindstopfen verschlossen werden!

### NOTE

Please fill all not used holes with clamping inserts made of solid material. Feed-throughs which are not used can be plugged with available blind plugs!



### ANWENDUNGSGEBIETE

- Anlagen-, Apparate- und Maschinenbau
- Mess- und Regeltechnik
- Antriebstechnik
- Mobile Studio- und Beleuchtungstechnik
- Windkraft- und Solarenergietechnik
- Elektroinstallation
- **FFEK-TPE-VO-RAIL**
- Schienenfahrzeuge gem. EN 45545-3: E30
- Schienenfahrzeuge gem. EN 45545-2: HL2 innen | HL3 außen
- Anlagen-, Apparate- und Maschinenbau

### APPLICATION

- plant, device and mechanical engineering
- measuring devices and controls
- drive engineering
- mobile studio and lighting technology
- wind power and solar energy technology
- electrical installation
- **FFEK-TPE-VO-RAIL**
- Railway industry acc. to EN 45545-3: E30
- Railway industry acc. to EN 45545-2: HL2 inside | HL3 outside
- Plant, device and mechanical Engineering



FLEXA No. FFEK-TPE-VO	FLEXA No. FFEK-TPE-VO-RAIL	Klemmbereich Clamping range	Durchführungen Feed-throughs	 kg St.   pce.	 Stück pieces
lichtgrau RAL 7035 light grey RAL 7035	lichtgrau RAL 7035 light grey RAL 7035	mm	Anzahl number		
1 0380 101 142	1 0380 103 142	2,0 - 3,0	14	0,026	5
1 0380 101 143	1 0380 103 143	3,0 - 4,0	14	0,024	5
1 0380 101 144	1 0380 103 144	4,0 - 4,5	14	0,022	5
1 0380 101 805	1 0380 103 805	4,5 - 5,5	8	0,020	5
1 0380 101 806	1 0380 103 806	5,5 - 6,5	8	0,019	5
1 0380 101 507	1 0380 103 507	6,5 - 7,5	5	0,018	5
1 0380 101 508	1 0380 103 508	7,5 - 8,5	5	0,017	5
1 0380 101 309	1 0380 103 309	8,5 - 9,5	3	0,020	5
1 0380 101 310	1 0380 103 310	9,5 - 10,5	3	0,019	5
1 0380 101 211	1 0380 103 211	10,5 - 12,5	2	0,020	5
1 0380 101 213	1 0380 103 213	12,5 - 14,5	2	0,018	5
1 0380 101 215	1 0380 103 215	14,5 - 16,5	2	0,014	5
1 0380 101 000	1 0380 103 000	Vollmaterial   full material	0	0,028	5

# FFEG – TPE – VO | FFEG – TPE – VO – RAIL

Klemmeinsätze – groß  
 Zum Einsetzen in die Klemmrahmen  
 FFR – AL – UL – ATEX und in die  
 Ringraumdichtung FFRR – TPE – VO

Clamping inserts – large  
 For assembling in the clamping frames  
 FFR – AL – UL – ATEX and in the  
 press ring seal FFRR – TPE – VO



IP 65  
 -40°C ... +100°C

## MATERIAL

TPE halogenfrei, selbstverlöschend

## EIGENSCHAFTEN

- VO [UL 94]
- einfache Bestückung der stabilen Rahmenkonstruktion durch Nut- und Federsystem, dadurch sind auch keine „Zwischenplatten“ notwendig
- erleichterte Kabel- oder Rohrdurchführung durch seitlichen Einführungsschlitz
- flammwidrig
- gute Beständigkeit gegen UV- Strahlung, Ozon, Säuren, Laugen, Kraftstoff, Lösungsmittel und Seewasser
- sehr gute Witterungsbeständigkeit

## TIPP

Nicht verwendete Öffnungen können mit Klemmeinsätzen aus Vollmaterial gefüllt werden.  
 Nicht benötigte Durchführungen können mit Blindstopfen verschlossen werden!

## ANWENDUNGSGEBIETE

- Anlagen-, Apparate- und Maschinenbau
- Mess- und Regeltechnik
- Antriebstechnik
- Mobile Studio- und Beleuchtungstechnik
- Windkraft- und Solarenergietechnik
- Elektroinstallation
- **FFEK – TPE – VO – RAIL**
- Schienenfahrzeuge gem. EN 45545-3: E30
- Schienenfahrzeuge gem. EN 45545-2: HL2 innen | HL3 außen
- Anlagen-, Apparate- und Maschinenbau

## MATERIAL

TPE free of halogen, self-extinguishing

## PROPERTIES

- VO [UL 94]
- simple, trouble free assembly of clamping inserts through a specially designed tongue and groove system eliminating the need for extra metal holders within the frame
- cable passes easily through the lateral slit in each clamping insert
- flame resistant
- resistant to UV radiation, ozone, acid, leach, petroleum, solvent, sea water corrosion resistant

## NOTE

Please fill all not used holes with clamping inserts made of solid material.  
 Feed-throughs which are not used can be plugged with available blind plugs!

## APPLICATION

- plant, device and mechanical engineering
- measuring devices and controls
- drive engineering
- mobile studio and lighting technology
- wind power and solar energy technology
- electrical installation
- **FFEK – TPE – VO – RAIL**
- Railway industry acc. to EN 45545-3: E30
- Railway industry acc. to EN 45545-2: HL2 inside | HL3 outside
- Plant, device and mechanical Engineering

Zubehör Accessories

Seite | page



FFBS – PA – VO

11.8

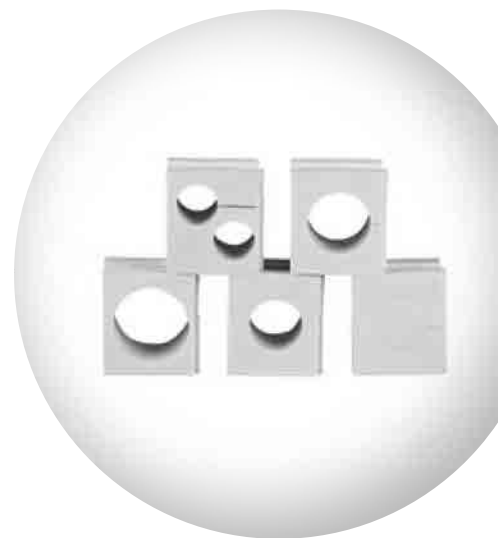

**FLEXA No.**  
FFEG – TPE – VO

**FLEXA No.**  
FFEG – TPE – VO – RAIL

Klemmbereich  
Clamping range

Durchführungen  
Feed-throughs



lichtgrau RAL 7035  
light grey RAL 7035

lichtgrau RAL 7035  
light grey RAL 7035

mm

Anzahl  
number

kg  
St. | pce.

Stück  
pieces

1 0380 201 217	1 0380 203 217	16,5 - 18,5	2	0,038	5
1 0380 201 119	1 0380 203 119	18,5 - 20,5	1	0,044	5
1 0380 201 121	1 0380 203 121	20,5 - 22,5	1	0,042	5
1 0380 201 123	1 0380 203 123	22,5 - 24,5	1	0,038	5
1 0380 201 125	1 0380 203 125	24,5 - 26,5	1	0,036	5
1 0380 201 127	1 0380 203 127	26,5 - 28,5	1	0,034	5
1 0380 201 129	1 0380 203 129	28,5 - 30,5	1	0,032	5
1 0380 201 131	1 0380 203 131	30,5 - 32,5	1	0,030	5
1 0380 201 133	1 0380 203 133	32,5 - 34,5	1	0,028	5
1 0380 201 000	1 0380 203 000	Vollmaterial   full material	0	0,054	5

 IP 64 | IP 65  
 -40°C ... +100°C

Zubehör Accessories

Seite | page



FFBS-PA-V0

11.8

## FFEK-TPE

Klemmeinsätze – klein  
 Zum Einsetzen in die Klemmrahmen  
 FFR-PA

### MATERIAL

TPE

### EIGENSCHAFTEN

- HB [UL 94]
- einfache Bestückung der stabilen Rahmenkonstruktion durch Nut- und Federsystem, dadurch sind auch keine „Zwischenplatten“ notwendig
- erleichterte Kabel- oder Rohrdurchführung durch seitlichen Einführungsschlitz
- flammwidrig
- gute Beständigkeit gegen UV-Strahlung, Ozon, Säuren, Laugen, Kraftstoff, Lösungsmittel und Seewasser
- sehr gute Witterungsbeständigkeit

### TIPP

Nicht verwendete Öffnungen können mit Klemmeinsätzen aus Vollmaterial gefüllt werden.

Nicht benötigte Durchführungen können mit Blindstopfen verschlossen werden!

### ANWENDUNGSGEBIETE

- Anlagen-, Apparate- und Maschinenbau
- Mess- und Regeltechnik
- Antriebstechnik
- Mobile Studio- und Beleuchtungstechnik
- Windkraft- und Solarenergietechnik
- Elektroinstallation

Clamping inserts – small  
 For assembling in the  
 clamping frames FFR-PA

### MATERIAL

TPE

### PROPERTIES

- HB [UL 94]
- simple, trouble free assembly of clamping inserts through a specially designed tongue and groove system eliminating the need for extra metal holders within the frame
- cable passes easily through the lateral slit in each clamping insert
- flame resistant
- resistant to UV radiation, ozone, acid, leach, petroleum, solvent, sea water
- corrosion resistant

### NOTE

Please fill all not used holes with clamping inserts made of solid material.

Feed-throughs which are not used can be plugged with available blind plugs!

### APPLICATION

- plant, device and mechanical engineering
- measuring devices and controls
- drive engineering
- mobile studio and lighting technology
- wind power and solar energy technology
- electrical installation



#### FLEXA No.

Klemmbereich  
Clamping range

Durchführungen  
Feed-throughs



schwarz  
black

mm

Anzahl  
number

kg  
St. | pce.

Stück  
pieces

1 0380 102 142	2,0 - 3,0	14	0,026	5
1 0380 102 143	3,0 - 4,0	14	0,024	5
1 0380 102 144	4,0 - 4,5	14	0,022	5
1 0380 102 805	4,5 - 5,5	8	0,020	5
1 0380 102 806	5,5 - 6,5	8	0,019	5
1 0380 102 507	6,5 - 7,5	5	0,018	5
1 0380 102 508	7,5 - 8,5	5	0,017	5
1 0380 102 309	8,5 - 9,5	3	0,020	5
1 0380 102 310	9,5 - 10,5	3	0,019	5
1 0380 102 211	10,5 - 12,5	2	0,020	5
1 0380 102 213	12,5 - 14,5	2	0,018	5
1 0380 102 215	14,5 - 16,5	2	0,014	5
1 0380 102 000	Vollmaterial   full material	0	0,028	5



# FFEG – TPE

Klemmeinsätze – groß  
Zum Einsetzen in die Klemmrahmen  
FFR – PA

Clamping inserts – large  
For assembling in the  
clamping frames FFR – PA

🔥 IP 64 | IP 65  
🌡️ -40°C ... +100°C

## MATERIAL TPE

### EIGENSCHAFTEN

- HB [UL 94]
- einfache Bestückung der stabilen Rahmenkonstruktion durch Nut- und Federsystem, dadurch sind auch keine „Zwischenplatten“ notwendig
- erleichterte Kabel- oder Rohrdurchführung durch seitlichen Einführungsschlitz
- gute Flammwidrigkeit
- gute Beständigkeit gegen UV-Strahlung, Ozon, Säuren, Laugen, Kraftstoff, Lösungsmittel und Seewasser
- sehr gute Witterungsbeständigkeit

### TIPP

Nicht verwendete Öffnungen können mit Klemmeinsätzen aus Vollmaterial gefüllt werden. Nicht benötigte Durchführungen können einfach mit Blindstopfen verschlossen werden!

### ANWENDUNGSGEBIETE

- Anlagen-, Apparate- und Maschinenbau
- Mess- und Regeltechnik
- Antriebstechnik
- Mobile Studio- und Beleuchtungstechnik
- Windkraft- und Solarenergietechnik
- Elektroinstallation

## MATERIAL TPE

### PROPERTIES

- HB [UL 94]
- simple, trouble free assembly of clamping inserts through a specially designed tongue and groove system eliminating the need for extra metal holders within the frame
- cable passes easily through the lateral slit in each clamping insert
- flame resistant
- resistant to UV radiation, ozone, acid, leach, petroleum, solvent, sea water
- corrosion resistant

### NOTE



Please fill all not used holes with clamping inserts made of solid material. Feed-throughs which are not used can be plugged with available blind plugs!

### APPLICATION

- plant, device and mechanical engineering
- measuring devices and controls
- drive engineering
- mobile studio and lighting technology
- wind power and solar energy technology
- electrical installation

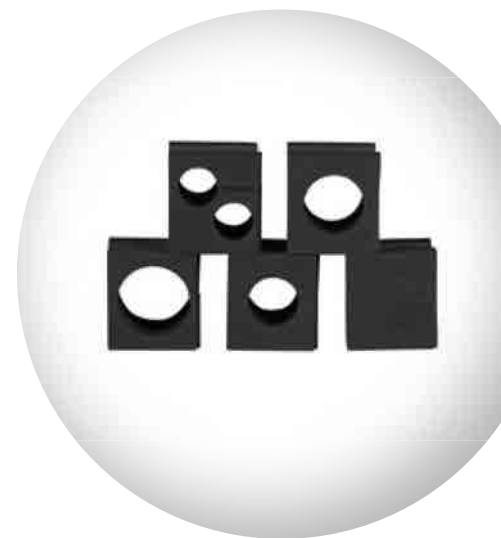
Zubehör	Accessories	Seite   page
	FFBS – PA – V0	11.8



FLEXA No.	Klemmbereich Clamping range	Durchführungen Feed-throughs	 kg St.   pce.	 Stück pieces
schwarz black	mm	Anzahl number	kg St.   pce.	Stück pieces
1 0380 202 217	16,5 - 18,5	2	0,038	5
1 0380 202 119	18,5 - 20,5	1	0,044	5
1 0380 202 121	20,5 - 22,5	1	0,042	5
1 0380 202 123	22,5 - 24,5	1	0,038	5
1 0380 202 125	24,5 - 26,5	1	0,036	5
1 0380 202 127	26,5 - 28,5	1	0,034	5
1 0380 202 129	28,5 - 30,5	1	0,032	5
1 0380 202 131	30,5 - 32,5	1	0,030	5
1 0380 202 133	32,5 - 34,5	1	0,028	5
1 0380 202 000	Vollmaterial   full material	0	0,054	5



V0 [UL 94]

🔥 -40°C ... +100°C

## FFBS-PA-V0

Blindstopfen für Klemmeinsätze  
Einfacher und problemloser Verschluss  
von nicht benötigten Durchführungen  
durch passende Blindstopfen

Blind plugs for clamping inserts  
Feed-throughs which are not used can  
be plugged with a simple blind plug

### MATERIAL

Kunststoff PA 6 GF30

### MATERIAL

PA 6 GF30 plastics

### EIGENSCHAFTEN

- V0 [UL94]
- selbstverlöschend

### PROPERTIES

- V0 [UL94]
- self-extinguishing

### ANWENDUNGSGEBIETE

- Anlagen-, Apparate- und Maschinenbau
- Mess- und Regeltechnik
- Antriebstechnik
- Mobile Studio- und Beleuchtungstechnik
- Windkraft- und Solarenergietechnik
- Elektroinstallation
- Bahn-Anwendungen gem. EN 45545-3:E30
- Bahn-Anwendungen gem. EN 45545-2:  
HL2 innen | HL3 außen
- Anlagen-, Apparate- und Maschinenbau

### APPLICATION

- plant, device and mechanical engineering
- measuring devices and controls
- drive engineering
- mobile studio and lighting technology
- wind power and solar energy technology
- electrical installation
- Rail Applications acc. to EN 45545-3: E30
- Rail Applications acc. to EN 45545-2:  
HL2 inside | HL3 outside
- plant, device and mechanical engineering



### FLEXA No

		Länge Length	 kg St.   pce.	 Stück pieces
schwarz black	Ø mm	mm		
1 0380 402 002	2,0	30,0	0,001	10
1 0380 402 003	3,0	30,0	0,001	10
1 0380 402 004	4,0	30,0	0,001	10
1 0380 402 005	5,0	30,0	0,001	10
1 0380 402 006	6,0	30,0	0,001	10
1 0380 402 007	7,0	30,0	0,001	10
1 0380 402 008	8,0	30,0	0,001	10
1 0380 402 009	9,0	30,0	0,001	10
1 0380 402 010	10,0	30,0	0,002	10
1 0380 402 012	12,0	30,0	0,004	10
1 0380 402 014	14,0	30,0	0,004	10
1 0380 402 016	16,0	30,0	0,006	10
1 0380 402 018	18,0	30,0	0,006	10

# FFRR – TPE – VO

Teilbare Ringraumdichtung  
 Abdichtung des Ringraumes zwischen  
 Futterrohr oder Kernbohröffnung und der  
 durchgeführten Leitung. Variable  
 Bestückung mit den Klemmeinsätzen.  
 Belegung mit max. 4 FFEG-,  
 8 FFEK-Klemmeinsätzen oder eine  
 beliebige Mischbestückung

Split press ring seal  
 For permanent closing of notched  
 holes and casings. Variable  
 assembling with the clamping  
 inserts. Maximum assignment  
 with 4 FFEG, 8 FFEK clamping  
 inserts or any mixed assembling

VO [UL 94]

🔥 -40°C ... +100°C

## MATERIAL

Rahmen Kunststoff PA 6 GF50  
 Dichtung TPE halogenfrei

## MATERIAL

Frame PA 6 GF50 plastics  
 Sealing halogen-free TPE

Zubehör

Accessoires

Seite | page

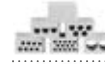

FFEK-TPE-VO 11.4



FFEG-TPE-VO 11.5



FFBS-PA-VO 11.8

## EIGENSCHAFTEN

- VO [UL94]
- Durchmesser Dichtbereich 148 - 153 mm
- leichte und schnelle Montage
- gas- und druckwasserdicht bis 1 bar
- Gummi-Dichtbreite: 30 mm
- selbstverlöschend
- RoHS- Konform
- geprüft nach DIN 5510-2 / 2009-05 mit der Brennbarkeitsklasse S3, Tropfbarkeitsklasse ST2 und der Rauchentwicklungsklasse SR2
- geprüft nach DIN EN ISO 5659-2
- gute Flammwidrigkeit
- gute Beständigkeit gegen UV-Strahlung, Ozon, Säuren, Laugen, Kraftstoff, Lösungsmittel und Seewasser
- sehr gute Witterungsbeständigkeit

## PROPERTIES

- VO [UL94]
- diameter sealing range 148 - 153 mm
- quick and easy assembly
- gas- and waterproof tight up to 1 bar
- rubber-sealed width: 30 mm
- self-extinguishing
- RoHS compliant
- approved acc. to DIN 5510-2 / 2009-05 with the flammability SR2, forming drops ST2 and the smoke development class SR2
- approved acc. to DIN EN ISO 5659-2
- good flame resistance
- good resistance to UV radiation, ozone, acids, alkalis, fuel, solvents and sea water
- excellent resistance in all weather conditions

## ANWENDUNGSGEBIETE

- Anlagen-, Apparate- und Maschinenbau
- Mess- und Regeltechnik
- Antriebstechnik
- Mobile Studio- und Beleuchtungstechnik
- Windkraft- und Solarenergietechnik
- Elektroinstallation



## APPLICATION

- plant, device and mechanical engineering
- measuring devices and controls
- drive engineering
- mobile studio and lighting technology
- wind power and solar energy technology
- electrical installation



1 x Rastereinheit [RE]=  
 1 x Klemmeinsatz klein  
 2 x Rastereinheit [RE] =  
 1 x Klemmeinsatz groß

1 x rack unit =  
 1 x clamping insert small  
 2 x rack unit =  
 1 x clamping insert large

FLEXA No.	Raster Rack	Ø	Tiefe Depth	 kg	 Stück piece
schwarz black	Einheit unit	mm	mm	St.   pce.	
1 0380 120 404	2 x 4	148,0	50,0	0,646	1

IP 66

-30°C ... +100°C

## FFKEP – PA

Kabeldurchführungsplatte  
Werkzeugfreies System zur Einführung  
und Abdichtung von Kabel an Gehäusen,  
Maschinen und Schaltschränken

Cable entry plate  
An alternative system for the insertion and  
sealing of cables for enclosures, machines  
and control cabinets without any tools

### MATERIAL

Flanschrahmen Kunststoff PA6 V0  
Platte Elastomer  
Dichtung TPE

### MATERIAL

Flange PA6 V0 plastics  
Plate elastomer  
Sealing TPE

### EIGENSCHAFTEN

- V0 [UL 94]
- schnelle und einfache Montage
- die Kabel werden durch die bereits vorgestanzte Elastomerplatte gedrückt
- Kabel einstecken und fertig
- die Elastomerplatte umschließt das Kabel – dazu wird eine sehr hohe Packungsdichte erzielt
- die Kabeldurchführungsplatten können durch Einrasten in die einzelnen Ausschnitte werkzeugfrei montiert werden
- ozonbeständig
- UL / CSA-File E140310

### PROPERTIES

- V0 [UL 94]
- quick and easy assembly
- the cables are simply pushed through the pre-punched elastomeric plate
- insert the cable – job finished
- the elastomeric plate encloses the cable – a very high packing density is achieved
- simply snap the cable entry plates 'tool-free' into the various notches
- ozone resistant
- UL / CSA-File E140310

### BEFESTIGUNG

Montage bei Blechdicken von 1,5 bis 2,0 mm, auf Montageausschnitte Größe 24 für Industrie-Steckverbinder, bei Blechstärken über 2,0 mm kann die Durchführungsplatte angeschraubt werden

### MOUNTING

In wall thickness from 1.5 to 2.0 mm usable on panel cut-outs size 24 for industrial multipole connectors, for plates with thicknesses greater than 2.0 mm the cable entry plate can be attached

### ANWENDUNGSGEBIETE

- Anlagen-, Apparate- und Maschinenbau
- Mess- und Regeltechnik
- Antriebstechnik
- Mobile Studio- und Beleuchtungstechnik
- Windkraft- und Solarenergietechnik
- Elektroinstallation

### APPLICATION

- plant, device and mechanical engineering
- measuring devices and controls
- drive engineering
- mobile studio and lighting technology
- wind power and solar energy technology
- electrical installation



### FLEXA No.

Kabel Außen-Ø [mm]  
Cable outer Ø [mm]



schwarz black RAL 9005	3,0 – 5,5		3,0 – 6,5		4,1 – 8,1		5,0 – 9,2		8,0 – 12,0		8,0 – 12,5		9,0 – 14,0		9,6 – 15,9		14,0 – 20,0		kg St./pce.	Stück piece
1 0380 502 011	-	4	-	4	-	-	-	-	-	-	-	-	-	-	-	-	-	3	0,091	1
1 0380 502 012	-	-	-	-	-	-	12	-	-	-	-	-	-	-	-	-	-	-	0,092	1
1 0380 502 013	2	-	6	-	-	-	-	-	-	4	-	-	-	-	-	-	-	1	0,091	1
1 0380 502 014	-	6	-	4	-	-	-	-	-	-	-	-	4	-	-	-	-	-	0,094	1
1 0380 502 017	-	-	-	17	-	-	-	-	-	-	-	-	-	-	-	-	-	-	0,093	1
1 0380 502 018	-	11	1	-	-	-	5	-	-	-	-	-	-	-	-	-	-	-	0,094	1
1 0380 502 022	-	16	-	4	-	-	2	-	-	-	-	-	-	-	-	-	-	-	0,093	1
1 0380 502 023	-	-	23	-	-	-	-	-	-	-	-	-	-	-	-	-	-	-	0,090	1
1 0380 502 029	-	29	-	-	-	-	-	-	-	-	-	-	-	-	-	-	-	-	0,098	1
1 0380 502 000	-	-	-	-	-	-	-	-	-	-	-	-	-	-	-	-	-	-	0,105	1

Außenmaße Länge: 147,5 mm, Breite: 59,5 mm

Outer dimensions Length: 147.5 mm, Width: 59.5 mm



# 12

## TECHNISCHE DATEN TECHNICAL DATA



### FLEXA BIETET WEIT MEHR ALS KABELSCHUTZ- SYSTEME VON DER STANGE.

Unsere Entwicklungsingenieure stellen sich mit Know-how und persönlichem Ehrgeiz jeder Herausforderung. So sind wir in der Lage, mit Hilfe modernster CAD-Anlagen maßgeschneiderte Lösungen in 3D zu konzipieren.

### FLEXA OFFERS A LOT MORE THAN JUST STANDARDIZED PROTECTIVE TUBING SYSTEMS.

Our experienced and ambitious development engineers accept any challenge. This drive, as well as our latest CAD equipment, allows us to design customized solutions in 3D.

Gewindearten   Gewindeabmessungen Thread types   Thread dimensions	2
.....	
Anzugdrehmomente Tightening torques	3
.....	
Definition der Schutzarten Brandschutzklassen Definition of the protective systems Fire protection classes	4 – 6
.....	
VDE-Bestimmungen Produktnormen VDE specifications Product standards	7
.....	
Schutzschlauchsysteme nach EN 45545 Anwendungsbereiche Bahntechnik   Zertifikate und Prüfungen Protective Conduit Systems acc. to EN 45545 Applications Railway Technology   Certificates and tests	8 – 9
.....	
Klassifizierung für flexible Elektroinstallationsrohrsysteme Classification for flexible conduit system	10 – 13
.....	
Chemische Beständigkeit von Kunststoffen Chemical resistance of plastic materials	14 – 17
.....	
Prüfmethoden Testing methods	18 – 19
.....	
Fachgerechtes Trennen von Schutzschläuchen Skilled parting of protective conduits	20 – 21
.....	
Artikel-Nummern Verzeichnis Article number index	22 – 25
.....	
Allgemeine Lieferbedingungen General Terms and Conditions	28 – 31
.....	
Repräsentanten und Partner Agents and distributors	32 – 33
.....	

## GEWINDENORMEN

### THREAD STANDARDS

Gewinde thread PG			Gewinde thread metric			Gewinde thread Whitworth-R			Gewinde thread NPT			Gewinde thread UNEF			
PG	Außen outer Ø	Steigung pitch	M	Außen outer Ø	Steigung pitch	CTG	R	Außen outer Ø	Steigung pitch	NPT	Außen outer Ø	Steigung pitch	UNEF	Außen outer Ø	Steigung pitch
			10	10,0	1,0								1/2"	(0,5000)-28	12,700 0,907
7	12,5	1,27	12	12,0	1,5										
								1/4"	13,16 1,34	1/4"	13,716 1,411				
9	15,2	1,41											5/8"	(0,6250)-24	15,875 1,058
			16	16,0	1,5										
										3/8"	17,145 1,411				
11	18,6	1,41											(0,7500)-20	19,050 1,270	
13,5	20,4	1,41	20	20,0	1,5	G 16	1/2"	20,96 1,81							
										1/2"	21,336 1,814				
16	22,5	1,41											7/8"	(0,8750)-20	22,225 1,270
													15/16"	(0,9375)-20	23,813 1,270
			25	25,0	1,5								1"	(1,0000)-20	25,400 1,270
						G 22	3/4"	26,44 1,81		3/4"	26,670 1,814				
21	28,3	1,588											1 3/16"	(1,1875)-18	30,163 1,411
			32	32,0	1,5										
						G 28	1"	33,25 2,31		1"	33,401 2,208				
													1 7/16"	(1,4375)-18	36,513 1,411
29	37,0	1,588													
			40	40,0	1,5										
						G 36	1 1/4"	41,91 2,208		1 1/4"	42,164 2,208		1 3/8"	(1,375) -18	34,925 1,411
													1 3/4"	(1,7500)-18	44,450 1,7205
36	47,0	1,588	50	50,0	1,5	G 42	1 1/2"	47,8 2,31							
										1 1/2"	48,260 2,208				
													2"	(2,0000)-18	50,8 1,9706
42	54,0	1,588													
48	59,3	1,588				G 54	2"	59,61 2,31		2"	60,325 2,208				
			63	63,0	1,5										
PG-Gewinde nach DIN 40430	M-Gewinde nach EN 60423 bzw. IEC 423 oder BS 6053 ISO 68/DIN13					G-Gewinde nach JIS B 0204 bzw. DIN ISO 228-1 oder BS 2779				NPT-Gewinde nach ANSI / ASME B 1.20.1			UNEF Gewinde nach ANSI / ASME B 1.1		
PG thread acc. to DIN 40430	M thread acc. to EN 60423 resp. IEC 423 or BS 6053 ISO 68/DIN 13					G thread acc. to JIS B 0204 resp. DIN ISO 228-1 or BS 2779				G thread acc. to JIS B 0204 resp. DIN ISO 228-1 or BS 2779			UNEF thread acc. to ANSI / ASME B 1.1		



## ANZUGDREHMOMENTE

In ein Gehäuse mit Innengewinde bzw. bei Durchgangsbohrungen in die Gegenmutter.

Hinweis:  
Die Tabellenwerte sind allgemeine Vorgaben, die Vorgehensweise muss werkstoffgerecht erfolgen.

Anzugsdrehmomente für Anschlussgewinde [Nm]  
Tightening torques for connecting thread [Nm]

Metr. EN 60423	Messing vernickelt nickel-plated brass	Kunststoff plastics
10 x 1,0	3,00	2,00
12 x 1,5	4,50	3,00
16 x 1,5	6,00	4,50
20 x 1,5	7,50	5,00
25 x 1,5	8,00	7,50
32 x 1,5	12,00	10,00
40 x 1,5	14,00	12,00
50 x 1,5	16,00	15,00
63 x 1,5	18,00	18,00

Anzugsdrehmomente für Zugentlastung [Nm]  
Tightening torques for strain relief [Nm]

Metr. EN 60423	Messing vernickelt nickel-plated brass	Kunststoff plastics
12 x 1,5	3,50	0,70
16 x 1,5	3,50	2,00
20 x 1,5	5,00	2,70
25 x 1,5	6,50	5,00
32 x 1,5	10,00	7,50
40 x 1,5	13,50	7,50
50 x 1,5	13,50	7,50
63 x 1,5	13,50	7,50

Anzugsdrehmomente für Anschlussgewinde nach DIN EN 562444 | DIN VDE 0619 [Nm]  
Tightening torques for strain relief acc. to DIN EN 562444 | DIN VDE 0619 [Nm]

Metr. EN 60423	Messing vernickelt nickel-plated brass	Kunststoff plastics
12 x 1,5	5,00	0,90
16 x 1,5	5,00	3,00
20 x 1,5	7,50	4,00
25 x 1,5	10,00	7,50
32 x 1,5	15,00	10,00
40 x 1,5	20,00	10,00
50 x 1,5	20,00	10,00
63 x 1,5	20,00	10,00

## TIGHTENING TORQUES

In a housing with an internal thread or with in the locknut through holes.

Note:  
The table values are general guidelines, the procedure must be appropriate for the material.

PG DIN 40430	Messing vernickelt nickel-plated brass	Kunststoff plastics
7	4,00	2,00
9	4,50	2,50
11	5,00	3,00
13,5	7,50	3,50
16	8,50	6,50
21	10,00	7,50
29	12,00	10,00
36	14,00	12,00
42	15,00	14,00
48	18,00	16,00

PG DIN 40430	Messing vernickelt nickel-plated brass	Kunststoff plastics
7	3,00	0,50
9	3,50	0,70
11	3,50	2,00
13,5	5,00	2,70
16	6,50	5,00
21	10,00	7,50
29	13,50	7,50
36	13,50	7,50
42	13,50	7,50
48	14,00	8,00

PG DIN 40430	Messing vernickelt nickel-plated brass	Kunststoff plastics
7	6,25	2,50
9	6,25	3,75
11	6,25	3,75
13,5	6,25	3,75
16	7,50	5,00
21	10,00	7,50
29	10,00	7,50
36	10,00	7,50
42	10,00	7,50
48	10,00	7,50

DEFINITION DER SCHUTZARTEN NACH EN 60529 / IEC 60529

DEFINITION OF THE PROTECTIVE SYSTEMS ACC. TO EN 60529 / IEC 60529

Die Schutzarten werden durch ein Kurzzeichen angegeben, das sich aus zwei stets gleichbleibenden Kennbuchstaben IP und zwei Kennziffern für den Schutzgrad zusammensetzt, zum Beispiel IP 68 [6 = 1. Kennziffer 8 = 2. Kennziffer]

The protective systems are stated through a short-code sign, composing of the two unchangeable indicating letters IP and two indexes for the protection degree i.e. IP 68 [6 = First Index 8 = Second Index]

1. KENNZIFFER  
FIRST INDEX

SCHUTZGRADE FÜR BERÜHRUNGS- UND FREMDKÖRPERSCHUTZ  
PROTECTION DEGREES FOR CONTACT | FOREIGN BODY PROTECTION

Kennziffer Index	Benennung Designation	Schutzumfang Erklärung	Protectionscope Description
<b>X</b>			
<b>0</b>	Kein Schutz No protection	Kein besonderer Schutz von Personen gegen direktes Berühren aktiver oder bewegter Teile. Kein Schutz des Betriebsmittels gegen Eindringen von festen Fremdkörpern.	No special protection of persons against direct touch of active or agitated particles. No protection of resources against penetration of solid foreign bodies.
<b>1</b>	Schutz gegen große Fremdkörper Protection against large sized foreign bodies	Schutz gegen zufälliges großflächiges Berühren aktiver und innerer bewegter Teile, z. B. mit der Hand, aber kein Schutz gegen absichtlichen Zugang zu diesen Teilen. Schutz gegen Eindringen von festen Fremdkörpern mit einem Durchmesser größer als 50 mm.	Protection against accidental large area contact of active and inner agitated particles, i.e. with the hand, but no protection against intentional access to these particles. Protection against penetration of solid foreign bodies with a diameter larger than 50 mm.
<b>2</b>	Schutz gegen mittelgroße Fremdkörper Protection against medium sized foreign bodies	Schutz gegen Berühren mit den Fingern aktiver oder innerer bewegter Teile. Schutz gegen Eindringen von festen Fremdkörpern mit einem Durchmesser größer als 12 mm.	Protection against contact of fingers with active or inner agitated particles. Protection against penetration of solid foreign bodies with a diameter larger than 12 mm.
<b>3</b>	Schutz gegen kleine Fremdkörper Protection against small sized foreign bodies	Schutz gegen Berühren aktiver oder innerer bewegter Teile mit Werkzeugen, Drähten o. ä. von einer Dicke größer als 2,5 mm. Schutz gegen Eindringen von festen Fremdkörpern mit einem Durchmesser größer als 2,5 mm.	Protection against contact of active or inner agitated particles with tools, wires or similars with a thickness of more than 2.5 mm. Protection against penetration of solid foreign bodies with a diameter larger than 2.5 mm.
<b>4</b>	Schutz gegen kornförmige Fremdkörper Protection against granulated foreign bodies	Schutz gegen Berühren aktiver oder innerer bewegter Teile mit Werkzeugen, Drähten o. ä. von einer Dicke größer als 1 mm.	Protection against contact of active or inner agitated particles with tools, wires or similars with a thickness of more than 1 mm.
<b>5</b>	Schutz gegen Staubablagerung Protection against dust deposit	Vollständiger Schutz gegen Berührungen unter Spannung stehender oder innerer bewegter Teile, Schutz gegen schädliche Staubablagerungen. Das Eindringen von Staub ist nicht vollkommen verhindert, aber der Staub darf nicht in solchen Mengen eindringen, dass die Arbeitsweise beeinträchtigt wird.	Complete protection against contact with current-carrying or inner agitated particles. Protection against harmful dust deposit. The penetration of dusts is not completely prevented, but the dust may not penetrate in such quantities that it injures procedures.
<b>6</b>	Schutz gegen Staubeintritt Protection against dust penetration	Vollständiger Schutz gegen Berühren unter Spannung stehender oder innerer sich bewegender Teile. Schutz gegen Eindringen von Staub.	Complete protection against contact with current-carrying or inner agitated particles. Protection against penetration of dust.

**1. KENNZIFFER**

Schutz gegen Berühren und Eindringen von Fremdkörpern

**FIRST INDEX**

Protection against contact and penetration of foreign bodies

**2. KENNZIFFER**

Schutz gegen Flüssigkeiten

**SECOND INDEX**

Protection against liquids

**2. KENNZIFFER  
SECOND INDEX**
**SCHUTZGRADE FÜR WASSERSCHUTZ  
PROTECTION DEGREES FOR WATER PROTECTION**

**IPXX**

Kennziffer Index	Benennung Designation	Schutzumfang Erklärung	Protectionscope Description
<b>X</b>			
<b>0</b>	Kein Schutz No protection	Kein besonderer Schutz.	No special protection.
<b>1</b>	Schutz gegen senkrecht fallendes Tropfwasser Protection against dripping water falling vertically	Wassertropfen, die senkrecht fallen, dürfen keine schädliche Wirkung haben.	Water drops falling vertically may not have any harmful consequences.
<b>2</b>	Schutz gegen schräg fallendes Wasser Protection against dripping water falling diagonally	Wassertropfen, die in einem beliebigen Winkel von 15° zur Senkrechten fallen, dürfen keine schädliche Wirkung haben.	Water drops falling in any angle of 15° to the vertical line may not have any harmful consequences.
<b>3</b>	Schutz gegen Sprühwasser Protection against spray water	Wasser, das in einem beliebigen Winkel bis 60° zur Senkrechten fällt, darf keine schädliche Wirkung haben.	Water falling in any angle up to 60° to the vertical line may not have any harmful consequences.
<b>4</b>	Schutz gegen Spritzwasser Protection against splashing water	Wasser, das aus allen Richtungen gegen das Betriebsmittel spritzt, darf keine schädliche Wirkung haben.	Water splashing from all directions onto resources may not have any harmful consequences.
<b>5</b>	Schutz bei Strahlwasser Protection against water jets	Ein Wasserstrahl aus einer Düse, der aus allen Richtungen gegen das Betriebsmittel gerichtet wird, darf keine schädliche Wirkung haben.	A water jet from a nozzle directed onto resources from all directions may not have any harmful consequences.
<b>6</b>	Schutz gegen Überflutung Protection against inundation	Wasser darf bei vorübergehender Überflutung, z. B. durch schwere Seen, nicht in schädlicher Menge in das Betriebsmittel eindringen.	In case of temporary inundation i.e. for heavy seas, water may not penetrate resources in harmful quantities.
<b>7</b>	Schutz beim Eintauchen Protection at immersion	Wasser darf nicht in schädlicher Menge eindringen, wenn das Betriebsmittel unter den festgelegten Druck- und Zeitbedingungen in Wasser eingetaucht wird.	Water may not penetrate in harmful quantities when resources are immersed into water under the determine pressure and time conditions.
<b>8</b>	Schutz beim Untertauchen Protection at submersion	Wasser darf nicht in schädlicher Menge eindringen, wenn das Betriebsmittel unter Wasser eingetaucht wird (1,2 m Wassertiefe, 1 Stunde).	Water may not penetrate in harmful quantities when resources are submerged under water (1.2 m water depth, 1 hour).

IP 69K NACH DIN 40050 | BRANDSCHUTZKLASSEN

IP 69K ACC. TO DIN 40050 | FIRE PROTECTION CLASSES



SCHUTZART IP 69K  
MIT DEM FLEXAquick® SYSTEM

Keine zusätzlichen Teile ohne weitere Montagezeiten. Die erhöhte Schutzart IP 69K gewährleistet zusätzlichen Schutz und höchste Systemdichtigkeit gegen Strahl- und Druckwasser besonders bei dem Einsatz von Hochdruck- und Dampfstrahlreinigern. Ein Muss überall dort, wo einfache Reinigungsmaßnahmen nicht ausreichen, wie in der Lebensmittelindustrie, im Fahrzeugbau, in Anlagen der Chemischen- und Pharma-Industrie.

Umfangreiche Tests des VDE Institutes haben bestätigt, dass wir mit unserem Verschraubungssystem ohne Zusatzteile die Dichtigkeitsstufe IP 69K nach DIN 40050 sicherstellen.

- einfachste Montage durch einteilige Verschraubungen mit push-in-Verschluss
- keine Zusatzteile notwendig
- keine zusätzlichen Montagezeiten
- keine Zusatzkosten
- risikoloser Einsatz von Hochdruck und Dampfstrahlreinigern



PROTECTION IP 69K  
WITH THE FLEXAquick® SYSTEM

No additional parts no additional mounting time. The higher protective classification 69K guarantees even better protection and utmost tightness against hose water and pressurized water during cleaning procedures with a high-pressure or a steam-jet washer. This is a must wherever simple cleaning is insufficient, e.g. in the food industry, in the automotive industry, in plants of chemical industries, in the pharmaceutical industry.

Comprehensive tests carried out by the VDE Institute have certified IP 69K tightness according to DIN 40050 of this screw connection system without additional parts.

- most simple assembly due to one-piece screw connections with push-in locks
- no additional parts required
- no additional mounting time
- no additional costs
- risk-free cleaning with high-pressure or steam-jet washers

BRANDSCHUTZKLASSEN NACH UL 94

FIRE PROTECTION CLASSES ACC. TO UL 94

HB

Langsames Brennen einer horizontal eingespannten Probe. Selbstverlöschend oder Brenngeschwindigkeit bei Dicke <3 mm; Rate <75 mm/min [HB75]; bei Dicke 3...13 mm; Rate <40 mm/min [HB40].

Slow burning on a horizontal specimen. Stop burning or burning rate for thickness <3 mm; rate < 75 mm/min [HB75]; for thickness 3...13 mm burning rate <40 mm/min [HB40].

V2

Selbstverlöschen einer vertikalen Probe innerhalb von 30 Sekunden. Brennendes Abtropfen von Kunststoffschmelze zulässig.

Burning stops within 30 seconds on a vertical specimen; drips of flaming particles are allowed.

V1

Selbstverlöschen einer vertikalen Probe innerhalb von 30 Sekunden. Kein brennendes Abtropfen von Kunststoffschmelze zulässig.

Burning stops within 30 seconds on a vertical specimen; drips of particles allowed as long as they are not inflamed.

V0

Selbstverlöschen einer vertikalen Probe innerhalb von 10 Sekunden. Kein brennendes Abtropfen von Kunststoffschmelze zulässig.

Burning stops within 10 seconds on a vertical specimen; drips of particles allowed as long as they are not inflamed.

IEC / DIN-EN / DIN-VDE

IEC / DIN-EN / DIN-VDE

**ANWENDUNGSBESTIMMUNGEN FÜR  
ELEKTRO-INSTALLATIONSSCHLÄUCHE**

**REQUIREMENTS FOR THE APPLICATION  
OF CONDUITS FOR ELECTRICAL INSTALLATIONS**

**DIN EN 60204 / IEC 60204 - 1**

Elektrische Ausrüstung von Maschinen

Electrical equipment of industrial machinery

**VDE 0113-1**

Errichtung von Starkstromanlagen mit  
Nennspannung bis 1000 V

Construction of power plants with rated voltages  
of up to 1000 V

**PRÜFBESTIMMUNGEN FÜR  
ELEKTRO-INSTALLATIONSSCHLÄUCH**

**APPROVAL REQUIREMENTS FOR  
ELECTRICAL INSTALLATION CONDUITS**

**DIN EN 61386 / IEC 61386 - 1**

Allgemeine Anforderungen  
Installationsrohrsysteme zum Führen von Leitungen  
für elektrische Energie und für Informationen

General requirements  
for cable management

**DIN EN 61386-23 / IEC 61386 - 23**

Besondere Anforderungen für  
flexible Installationsrohrsysteme  
zum Führen von Leitungen für  
elektrische Energie und für Informationen

Particular requirements for  
flexible conduit systems  
for cable management

**DIN EN 60529 / IEC 60529**

Schutzartprüfung durch Gehäuse [IP Code]

Degrees of protection provided by enclosures [IP code]

**PRODUKTNORMEN FÜR  
ELEKTRO-INSTALLATIONSSCHLÄUCHE**

**PRODUCT STANDARDS FOR  
CONDUITS FOR ELECTRICAL INSTALLATION**

**DIN 40430**

Stahlpanzerrohr-Gewinde [PG]

Rigid steel conduit threads [PG]

**DIN EN 60423**

Gewinde für Elektroinstallationsrohre und  
Verschraubungen [metrisch]

Threads for conduits for electrical installation and  
connectors [metric]

**DIN 49012**

Metallschläuche für schwere mechanische  
Beanspruchung

Flexible metal conduits for heavy mechanical stress

## SCHUTZSCHLAUCH SYSTEME NACH EN 45545.

PROTECTIVE CONDUIT SYSTEMS ACC. TO EN 45545.

### ANFORDERUNGEN NACH EN 45545-2

Ziel der EN45545-2 ist es, durch die Auslegung der ortsfesten Anlagen sowie der Fahrzeuge und die damit verbundene Auswahl der Werkstoffe, das Entstehen, die Ausbreitung und die Auswirkungen von Feuer und Rauch im Fall eines Brandes in Grenzen zu halten. Die Auswahl, die Verarbeitung und die Verwendung dieser Werkstoffe müssen eine gesundheits-schädliche oder -gefährdende Rauch- und Gasentwicklung, insbesondere im Fall eines Brandes, in Grenzen halten. Zusammenfassend lässt sich das Ziel wie folgt einfach be-schreiben: Die Entstehung des Brandes so gering wie möglich zu halten und im Brandfall die Ausbreitung und Auswirkungen zu verhindern.

Alle FLEXA-Bahnprodukte werden nach den Anforderungssätzen R22 (Innenbereich) und R23 (Außenbereich) auf die jeweilige HL-Klassifizierung (HL1-HL3) geprüft. In diesen Prüfungen wird die Entzündbarkeit, die Rauchdichte und die Rauchgastoxizität geprüft und bewertet. Diese Gefährdungsstufen wurden festgelegt, so dass eine Beziehung zwischen den Betriebsklassen und den Bauartklassen hergestellt werden kann.

### BETRIEBSKLASSEN

Für die brandschutztechnische Einstufung der Fahrzeuge werden diese in Abhängigkeit vom Risikopotential im Brandfall in vier Betriebsklassen eingestuft. Die Betriebsklasse für ein Schienenfahrzeug wird durch die Beziehung zwischen Betrieb, Infrastruktur und Rettungsbedingungen für Fahrgäste und Personal festgelegt.

### BAUARTKLASSEN

- N:** Standardfahrzeuge
- A:** Fahrzeuge für automatischen Fahrbetrieb, für Notfälle ist kein geschultes Personal an Bord.
- D:** Doppelstockfahrzeuge
- S:** Schlaf- und Liegewagen

### REQUIREMENTS AS PER EN 45545-2

EN45545-2 is to limit the combustion, the spread, and the effects of fire and of smoke in the case of a fire by designing stationary plants as well vehicles appropriately and by selecting suitable materials. Choosing, processing, and applying such materials must be subject to compliance with the regulations on hazardous smoke emissions and gas emissions, particularly in the case of a fire. In a nutshell, the target can be described as follows: fire combustion has to be minimized, and spread as well negative effects of a fire have to be prevented in case of a fire.

All FLEXA products related to railway vehicles are tested as per Requirements R22 (interior) and as per Requirements R23 (exterior) for corresponding HL Classification (HL1-HL3). These tests particularly focus on testing and assessing ignitability, smoke density, and smoke toxicity. Such threat levels have been determined in order to create a relation between the utilisation categories and the construction classes.

### UTILISATION CATEGORIES

Vehicles are categorized for fire protection purposes. There are four categories subject to a certain risk potential in the case of a fire. The so-called utilisation category for a railway vehicle is determined on the basis of vehicle operation, of the infrastruc-ture, and of prevailing rescue conditions for passengers and personnel.

### DESIGN CATEGORIES

- N:** Standard vehicles
- A:** Vehicles forming part of an automatic train and having no emergency trained staff on board.
- D:** Double-decked vehicles
- S:** Sleeping and couchette vehicles

## Zuordnung der Gefährdungsstufen [HL]

Allocation of Risk Classification [HL]

BETRIEBSKLASSE OPERATION CATEGORY		BAUARTKLASSE   DESIGN CATEGORY			
		N	A	D	S
1.	Sehr gute Evakuierungsmöglichkeit best enabling evacuation	HL1	HL1	HL1	HL2
2.	Gute Evakuierungsmöglichkeit good enabling evacuation	HL2	HL2	HL2	HL2
3.	Mittlere Evakuierungsmöglichkeit medium enabling evacuation	HL2	HL2	HL2	HL3
4.	Schlechte Evakuierungsmöglichkeit bad enabling evacuation	HL3	HL3	HL3	HL3

ANWENDUNGSBEREICHE BAHNTECHNIK  
APPLICATIONS RAILWAY TECHNOLOGY

BAHNTECHNIK  
RAILWAY TECHNOLOGY

AUSSEN-INSTALLATION OUTSIDE-INSTALLATION	
	Dynamisch   statisch min. IP 67 ⚡ -50°C bis +100°C
Produkte Products	ROHRflex® PA 12
	ROHRflex® PA 12-D
	ROHRflex® PA 12-F   PA 12-FD
	ROHRflex® PA 12-SD
	ROHRflex® MULTI PA 12

INNEN-INSTALLATION INSIDE-INSTALLATION	
	Statisch min. IP 54 ⚡ -40°C bis +100°C
Produkte Products	ROHRflex® PA 6
	ROHRflex® PA 6-D
	ROHRflex® MULTI PA 6
	SPR – AS   SPR – VA
	SPR – CU – AS [EMV   emc]



KUPPLUNGS- BEREICH COUPLING	
	Dynamisch   statisch min. IP 67 ⚡ -50°C bis +100°C
Produkte Products	ROHRflex® PA 12
	ROHRflex® PA 12-F
	ROHRflex® PA 12-FD
	ROHRflex® PA 12-S
	ROHRflex® PA 12-SD
	ROHRflex® MULTI PA 12

UNTERFLUR- INSTALLATION UNDERFLOOR INSTALLATION	
	Dynamisch   statisch min. IP 67 ⚡ -50°C bis +100°C
Produkte Products	ROHRflex® PA 12
	ROHRflex® PA 12-F
	ROHRflex® PA 12-FD
	ROHRflex® PA 12-S
	ROHRflex® PA 12-SD
	ROHRflex® MULTI PA 12

## KLASSIFIZIERUNG FÜR FLEXIBLE ELEKTROINSTALLATIONSROHRSYSTEME DIN EN IEC 61386-23

Angaben basieren auf der Abmessung AD 21,2

### ROHRFLEX® WELLSCHLÄUCHE ROHRFLEX® TUBINGS



**PA 6**  
V0 [UL 94]



**PA 6-D**  
V0 [UL 94]



**PA 6-S**  
V2 [UL 94]



**PA 6-L**  
HB [UL 94]



**PA 6-HT**  
V2 [UL 94]



**PA 6-CU**  
HB [UL 94]

### Zulassungen Recognition



	PA 6	PA 6-D	PA 6-S	PA 6-L	PA 6-HT	PA 6-CU
<b>A</b> Druckfestigkeit Resistance to compression	1	2	1	1	1	2
<b>B</b> Schlagfestigkeit Resistance to impact	3	4	3	3	4	3
<b>C</b> Min. Dauergebrauchs-   Installationstemperatur Lower temperature range	2	2	4	4	2	2
<b>D</b> Max. Dauergebrauchs-   Installationstemperatur Upper temperature range	4	2	4	4	5	4
<b>E</b> Widerstand gegen Biegung Resistance to bending	4	4	4	4	4	4
<b>F</b> Elektrische Eigenschaften Electrical characteristics	0	0	0	0	0	3
<b>G</b> Widerstand gegen das Eindringen von Festkörpern Resistance against ingress of solid objects	6	6	6	6	6	6
<b>H</b> Widerstand gegen das Eindringen von Wasser Resistance against ingress of water	7	7	7	7	6	7
<b>I</b> Korrosionsbeständigkeit Resistance against corrosion	–	–	–	–	–	4
<b>J</b> Zugfestigkeit Tensile strength	1	1	1	1	1	1
<b>K</b> Widerstand gegen Flammausbreitung Resistance to flame propagation	1	1	1	1	1	1
<b>L</b> Hängelast-Aufnahmefähigkeit Suspended load capacity	2	2	2	2	0	2

	A	B	C	D	E	F	G	H	I	J	K	L
	N	kg	°C min.	°C max.			Schutzklasse IP	Schutzklasse X		N		N
0	–	–	–	–	–	nicht erklärt	–	0	–	nicht erklärt	–	nicht erklärt
1	125	0,5	+5	+60	starr	mit elektrischen Leiteigenschaften	–	1	geringer Schutz	100	nicht flammverbreitend	20
2	320	1,0	-5	+90	biegsam	mit elektrischen Isolationseigenschaften	–	2	mittlerer Schutz	250	flammverbreitend	30
3	750	2,0	-15	+105	biegsam zurückbildend	mit elektrischen Leit- und Isolationseigenschaften	3	3	mittlerer Schutz innen hoher Schutz außen	500	–	150
4	1250	2,0	-25	+120	flexibel		4	4	hoher Schutz	1000	–	450
5	4000	6,8	-45	+150			5	5	–	2500	–	850
6	–	–	–	+250			6	6	–	–	–	–
7	–	–	–	+400			7	7	–	–	–	–



CLASSIFICATION FOR FLEXIBLE CONDUIT SYSTEMS FOR ELECTRICAL INSTALLATIONS DIN EN IEC 61386 PART 23

Details are based upon the dimension OD 21.2



PA 12  
V2 [UL 94]



PA 12-D  
V2 [UL 94]



PA 12-S  
V2 [UL 94]



PA 12-SD  
V2 [UL 94]



PA 12-F  
V2 [UL 94]



PA 12-FD  
V2 [UL 94]



PU  
HB [UL 94]



PP  
HB [UL 94]



1	2	1	2	1	2	-	1
1	3	1	3	1	3	-	4
5	5	5	5	5	5	5	4
4	4	4	4	4	4	4	2
4	4	4	4	4	4	4	4
0	2	0	2	0	2	2	2
6	6	6	6	6	6	6	6
7	7	7	7	7	7	7	7
-	-	-	-	-	-	-	-
1	2	1	2	1	2	-	1
1	1	1	1	1	1	1	1
0	2	0	2	0	2	-	2

	A	B	C	D	E	F	G	H	I	J	K	L
	N	kg	°C min.	°C max.			Protection class IP	Protection class X		N		N
0	-	-	-	-	-	non declared	-	0	-	non declared	-	non declared
1	125	0.5	+5	+60	rigid	with electrical continuity characteristic	-	1	low protection	100	non flame propagating	20
2	320	1.0	-5	+90	pliable	with electrical insulating characteristic	-	2	medium protection	250	flame propagating	30
3	750	2.0	-15	+105	pliable self revoc.	with electrical continuity and insulating characteristic	3	3	medium protection inside high protection outside	500	-	150
4	1250	2.0	-25	+120	flexible		4	4	high protection	1000	-	450
5	4000	6.8	-45	+150			5	5		2500	-	850
6	-	-	-	+250			6	6		-	-	-
7	-	-	-	+400			7	7		-	-	-

## KLASSIFIZIERUNG FÜR FLEXIBLE ELEKTROINSTALLATIONSROHRSYSTEME DIN EN IEC 61386-23

Angaben basieren auf der Abmessung AD 21,2

### METALLSCHUTZSCHLÄUCHE AUS METALL UND KUNSTSTOFF

PROTECTIVE CONDUITS MADE OF METAL AND PLASTICS



SPR-AS



SPR-EDU-AS



SPR-CU-AS



FLEXAgraff®-AS



FLEXAgraff®-CU-AS

Zulassungen Recognition	BWB PG	BWB PG	PG	PG	PG
<b>A</b> Druckfestigkeit Resistance to compression	3	4	4	4	4
<b>B</b> Schlagfestigkeit Resistance to impact	3	4	4	4	4
<b>C</b> Minimale Dauergebrauchs- und Installationstemperatur Lower temperature range	5	5	5	5	5
<b>D</b> Maximale Dauergebrauchs- und Installationstemperatur Upper temperature range	6	6	6	6	6
<b>E</b> Widerstand gegen Biegung Resistance to bending	4	4	4	4	4
<b>F</b> Elektrische Eigenschaften Electrical characteristics	1	1	1	1	1
<b>G</b> Widerstand gegen das Eindringen von Festkörpern Resistance against ingress of solid objects	4	4	4	4	5
<b>H</b> Widerstand gegen das Eindringen von Wasser Resistance against ingress of water	1	0	0	0	4
<b>I</b> Korrosionsbeständigkeit Resistance against corrosion	4	4	4	4	4
<b>J</b> Zugfestigkeit Tensile strength	3	4	4	4	4
<b>K</b> Widerstand gegen Flammausbreitung Resistance to flame propagation	1	1	1	1	1
<b>L</b> Hängelast-Aufnahmefähigkeit Suspended load capacity	4	4	4	3	3

	<b>A</b>	<b>B</b>	<b>C</b>	<b>D</b>	<b>E</b>	<b>F</b>	<b>G</b>	<b>H</b>	<b>I</b>	<b>J</b>	<b>K</b>	<b>L</b>
	N	kg	°C min.	°C max.			Schutzklasse IP	X		N		N
0	–	–	–	–	–	nicht erklärt	–	0	–	nicht erklärt	–	nicht erklärt
1	125	0,5	+5	+60	starr	mit elektrischen Leiteigenschaften	–	1	geringer Schutz	100	nicht flammverbreitend	20
2	320	1,0	-5	+90	biegsam	mit elektrischen Isolationseigenschaften	–	2	mittlerer Schutz	250	flammverbreitend	30
3	750	2,0	-15	+105	biegsam zurückbildend	mit elektrischen Leit- und Isolationseigenschaften	3	3	mittlerer Schutz Innen hoher Schutz außen	500	–	150
4	1250	2,0	-25	+120	flexibel		4	4	hoher Schutz	1000	–	450
5	4000	6,8	-45	+150			5	5	–	2500	–	850
6	–	–	–	+250			6	6	–	–	–	–
7	–	–	–	+400			7	7	–	–	–	–

CLASSIFICATION FOR FLEXIBLE CONDUIT SYSTEMS FOR ELECTRICAL INSTALLATIONS DIN EN IEC 61386 PART 23

Details are based upon the dimension OD 21.2



SPR-PVC-AS   SPR-PU-AS   SPR-PVC-EDU-AS   FLEXAgraff®-PU-AS   FLEXAgraff®-CU-PU   AIRflex®-KUW-PVC-AS   AIRflex®-KUW-PU-AS   LIQUID-TIGHT-EF

	4	4	4	4	4	4	4	4
	3	3	4	3	4	2	2	3
	4	5	4	5	5	2	3	3
	2	3	2	3	3	2	3	2
	4	4	4	4	4	4	4	4
	1	1	1	0	0	0	0	1
	6	6	6	6	6	5	5	6
	5	5	5	5	7	4	4	6
	4	4	4	4	4	4	4	4
	3	3	3	4	4	1	1	3
	1	1	1	0	0	0	0	1
	4	4	4	3	3	2	2	4

	<b>A</b>	<b>B</b>	<b>C</b>	<b>D</b>	<b>E</b>	<b>F</b>	<b>G</b>	<b>H</b>	<b>I</b>	<b>J</b>	<b>K</b>	<b>L</b>
	N	kg	°C min.	°C max.			Protection class IP	Protection class X		N		N
0	-	-	-	-	-	non declared	-	0	-	non declared	-	non declared
1	125	0.5	+5	+60	rigit	with electrical continuity characteristic	-	1	low protection	100	none flame propagating	20
2	320	1.0	-5	+90	pliable	with electrical insulating characteristic	-	2	medium protection	250	flame propagating	30
3	750	2.0	-15	+105	pliable self revoc.	with electrical continuity and insulating characteristic	3	3	medium protection inside high protection outside	500	-	150
4	1250	2.0	-25	+120	flexible		4	4	high protection	1000	-	450
5	4000	6.8	-45	+150			5	5		2500	-	850
6	-	-	-	+250			6	6		-	-	-
7	-	-	-	+400			7	7		-	-	-

## CHEMISCHE BESTÄNDIGKEIT

## KUNSTSTOFFE

+ beständig      o bedingt beständig      - nicht beständig

Reagens	Konzentration %	bei +°C	Polyamid	Polyamid	Polyamid	Polyurethan	Polypropylen	Weich-PVC	Silikon	Thermoplastisches Elastomer	Nitril-Butadien-Kautschuk
			PA 6	PA 66	PA 12	PU	PP	PVC	SI*	TPE	NBR
Abgase, kohlenstoffhaltig	jede	60	+	+	+			+	+		+
Abgase, SO <sub>2</sub> -haltig	gering	60	+	+	+		+	+	o		+
Acetaldehyd, wässrig	40	20	o	o	+		o	-	o		-
Aceton	100	20	+	+	+	-	+	-	o	o	-
Acrylsäure	100	>30	-	-	-		-	-	o		-
Alaune, wässrig	verdünnt	40	o	o	o		+	+			20°C+
Allylalkohol	96	20	o	o	+		+	-	+		+
Aluminiumchlorid, wässrig	verdünnt	40	o	o	o	+	+	+	o/-	+	20°C+
Aluminiumsulfat, wässrig	verdünnt	40	+	+	+		+	+	+	+	20°C+
Ameisensäure, wässrig	10	20	o	o	+		+	+	o	+	o
Ammoniak, wässrig	gesättigt	20	20%+	20%+	+	+	+	o	o	o	+
Ammoniumchlorid, wässrig	gesättigt	60	o	o	o	3%o	+	o	o	+	20°C+
Ammoniumnitrat, wässrig	verdünnt	40	+	+	+		+	+	+		20°C+
Ammoniumsulfat, wässrig	verdünnt	40	+	+	+		+	+	+	+	+
Anilin, rein	100	20	o	o	o	-	+	-	o	o	-
Benzaldehyd, wässrig	gesättigt	20	reino	reino	reino		+	-	-	o	-
Benzin	100	20	+	+	+	+	o	-	-	o	+
Benzoessäure, wässrig	jede	40	20%o	20%o	20%o		+	20°C+	-		+
Benzol	100	20	+	+	+	-	o	-	-	-	-
Bleichlauge	12,5Cl	20	-	-	o	3%-	+	+	o		-
Bohröl			+	+	+			-	o		+
Borax, wässrig	verdünnt	40	+	+	+		+	+	o	+	20°C+
Borsäure, wässrig	verdünnt	40	o	o	o	3%o	+	20°C+	o	+	20°C+
Brom, flüssig	100	20	-	-	-		-	-	-	-	-
Bromwasserstoffsäure, wässrig	bis10	40	-	-	-		50%+	o	o	-	-
Butandiol, wässrig	bis10	20	rein+	rein+	rein+		+	o	o		-
Butanol	bis100	20	+	+	+	-	+	-	o		+
Butylacetat	100	20	+	+	+	-	o	-	o	-	-
Calciumchlorid, wässrig	gesättigt	40	+	+	+		+	+	+	+	20°C+
Chlor	jede	20	-	-	-		o	-	-	o	-
Chromalaun, wässrig	verdünnt	40					+	+			20°C+
Cyclohexanol	-	20	+	+	+	o	+	-	o	-	-
Dieselmotorenöl		85	+	+	+	20°C+	o	-	o		+
Eisenchlorid, wässrig, neutral	10	20	+	+	+	40°Co	+	+	+	+	+
Eisessig	100	20	+	+	+		+	-	o	o	-
Essigsäure	10	20	o	o	+	3%o	+	+	o	+	-
Ethylalkohol, wässrig	10	20	40Vol.-%+	40Vol.-%+	40Vol.-%+		+	+	+	+	+
Ethylenchlorid	100	20	o	o	o		-	-	-	o	-
Ethylenoxid	100	20	+	+	+		+	-	-	-	-
Ethylether	100	20	+	+	+	o	o	-		-	o
Ferricyankalium, wässrig	gesättigt	60	o	o	o		+	+			+
Fluor	50	40	rein-	rein-	rein-		-	-	-		-
Formaldehyd, wässrig	verdünnt	40	rein+	rein+	reino		40%+	20°Co	o	40%+	20°C-
Glukose, wässrig	jede	50					+	+	+		+
Harnstoff, wässrig	bis10	40	20%+	20%+	20%+		+	+	+		+
Hydraulikflüssigkeit, schwerentflammbar		80	+	+	+		+	-	-		-
Hydrauliköl HL (DIN 51524)		100	+	+	+			-	-		o
Hydroxylaminsulfat, wässrig	bis12	30	+	+	+		+	o			+
Kalilauge, wässrig	50	20	+	+	+		+	+	o	10%+	o
Kaliumbromid, wässrig	jede	20	10%o	10%o	10%+		+	+	+	+	+

\*Silikon ist gasdurchlässig

## KUNSTSTOFFE

## CHEMISCHE BESTÄNDIGKEIT

+ beständig      o bedingt beständig      - nicht beständig

Reagens	Konzentration %	bei +°C										
			Polyamid	Polyamid	Polyamid	Polyurethan	Polypropylen	Weich-PVC	Silikon	Thermoplastisches Elastomer	Nitril-Butadien-Kautschuk	
			PA6	PA 66	PA 12	PU	PP	PVC	SI*	TPE	NBR	
Kaliumchlorid, wäbrig	10	20	+	+	+							
Kaliumdichromat, wäbrig	40	20	5%o	5%o	5%o							
Kaliumnitrat, wäbrig	jede	20	10%+	10%+	10%+							
Kaliumpermanganat, wäbrig	gesättigt	20										
Kieselfluorwasserstoffsäure, wäbrig	bis30	20	-	-								
Kohlendioxid, trocken	100	60									20°C+	
Kohlensäure	100	60	+	+	+						20°C+	
Kresol, wäbrig	bis90	20	rein-	rein-								
Kühlflüssigkeiten DIN53521		120	o	o	+							
Kupferchlorid, wäbrig	gesättigt	20										
Kupfersulfat, wäbrig	gesättigt	60	+	+	+						20°C+	
Magnesiumcarbonat, wäbrig	gesättigt	100										
Magnesiumchlorid, wäbrig	gesättigt	20	10%+	10%+	10%+							
Methylalkohol	100	20	+	+	+							
Methylenchlorid	100	20	o	o	o	-						
Milchsäure, wäbrig	bis90	20	10%+	10%+	10%+	3%o						
Mineralöle			+	+	+	80°C+	20°C+	20°Co	o	-	+	
Natriumchlorat, wäbrig	gesättigt	20	10%o	10%o	10%o							
Natronlauge, wäbrig	10	20	+	+	+	3%o						
Nickelchlorid, wäbrig	gesättigt	20	10%o	10%o	10%o							
Nickelsulfat, wäbrig	gesättigt	20	10%o	10%o	10%o							
Nitroglycerin	verdünnt	20										
Öle und Fette		20	+	+	+							
Ölsäure	-	20	+	+	+							
Oxalsäure, wäbrig	jede	20	10%o	10%o	10%o	3%o						
Ozon	rein		-	-	-							
Petroleum	100	80	+	+	+							
Phosgen, gasförmig	100	20										
Phosphorsäure, wäbrig	verdünnt	20	10%-	10%-	10%-	3%o	85%+	50%+	85%o	85%+	-	
Phosphorpentoxid	100	20										
Quecksilber	rein	20	+	+	+							
Salpetersäure, wäbrig	50	20	-	-	-	20%-	o	o	10%o	30%o	-	
Salzsäure, wäbrig	30	20	20%-	20%-	20%-	20%o	+	10%+	10%+	10%+	o	
Schmierfette, Basis Esteröle		110	o	o	+							
Schmierfette, Basis Polyphenylester		110	+	+	+							
Schmierfette, Basis Silikonöle		110	+	+	+							
Schwefelkohlenstoff	100	20	+	+	+							
Schwefelsäure, wäbrig	10	20	-	-	-	20%o	85%+	+	10%+	98%+	o	
Seewasser		40	+	+	+	20°C+	+	+	+	+	20°C+	
Seifenlösung, wäbrig	verdünnt	20	+	+	+	+	+	+	+	+	+	
Tetrachlorkohlenstoff	100	20	+	+	+	-	-	-	-	-	-	
Toluol	100	20	+	+	+	-	o	-	-	+	-	
Trichlorethen	100	20	o	o	o							
Vinylacetat	100	20										
Wasserstoff	100	60	20°C+	20°C+	20°C+							
Xylol	100	20	+	+	+							
Zinkchlorid, wäbrig	verdünnt	60	10%o	10%o	10%o							
Zinksulfat, wäbrig	verdünnt	60										
Zinnchlorid	verdünnt	40										
Zitronensäure	bis10	40	20°C+	20°C+	20°C+	3%o	+	20°C+	+	+	20°C+	

Quelle : Kunststoff-Tabellen, B. Carlowitz, Carl Hanser Verlag und andere

Die oben genannten Angaben ermöglichen eine Vorauswahl. Sie dienen jedoch nicht dazu, bestimmte Eigenschaften der Produkte oder deren Eignung für einen konkreten Einsatzzweck zuzusichern. Sie entbinden den Käufer nicht von der ihm obliegenden Eingangskontrolle.

## CHEMICAL RESISTANCE

## PLASTIC MATERIALS

+ resistant      o conditionally resistant      - not resistant

Reagens	Concentration %	at temp. +°C	Polyamide	Polyamide	Polyamide	Thermoplastic Polyurethane	Polypropylene	Soft PVC	Silicone	Thermoplastic Elastomer	Nitrile Butadiene rubber
			PA 6	PA 66	PA 12	PU	PP	PVC	SI*	TPE	NBR
Acetaldehyde, hydrous	40	20	o	o	+		o	-	o		-
Acetic acid	10	20	o	o	+	3%o	+	+	o	+	-
Acetic acid pure	100	20	+	+	+		+	-	o	o	-
Acetone	100	20	+	+	+	-	+	-	o	o	-
Acrylic acid	100	>30	-	-	-		-	-	o		-
Allyl alcohol	96	20	o	o	+		+	-	+		+
Alum,hydrous	dilute	40	o	o	o		+	+			20°C+
Aluminium chloride, hydrous	dilute	40	o	o	o	+	+	+	o/-	+	20°C+
Aluminium sulphate, hydrous	dilute	40	+	+	+		+	+	+	+	20°C+
Ammonia solution, hydrous	saturated	20	20%+	20%+	+	+	+	o	o	o	+
Ammonium chloride, hydrous	saturated	60	o	o	o	3%o	+	o	o	+	20°C+
Ammonium nitrate, hydrous	dilute	40	+	+	+		+	+	+		20°C+
Ammonium sulphate, hydrous	dilute	40	+	+	+		+	+	+	+	+
Aniline, pure	100	20	o	o	o	-	+	-	o	o	-
Benzaldehyde, hydrous	saturated	20	pureo	pureo	pureo		+	-	-	o	-
Benzine	100	20	+	+	+	+	o	-	-	o	+
Benzoic acid, hydrous	any	40	20%o	20%o	20%o		+	20°C+	-		+
Benzole	100	20	+	+	+	-	o	-	-	-	-
Bleaching liquor	12,5Cl	20	-	-	o	3%-	+	+	o		-
Borax, hydrous	dilute	40	+	+	+		+	+	o	+	20°C+
Boric acid, hydrous	dilute	40	o	o	o	3%o	+	20°C+	o	+	20°C+
Bromine, liquid	100	20	-	-	-		-	-	-	-	-
Butandiol, hydrous	upto10	20	pure+	pure+	pure+		+	o	o		-
Butanol	upto100	20	+	+	+	-	+	-	o		+
Butylacetate	100	20	+	+	+	-	o	-	o	-	-
Calcium chloride, hydrous	saturated	40	+	+	+		+	+	+	+	20°C+
Carbon dioxide	100	60	+	+	+			o	+	o	20°C+
Carbon dioxide, dry	100	60					+	+	+	o	20°C+
Carbon tetrachloride	100	20	+	+	+	-	-	-	-	-	-
Caustic potash solution, hydrous	50	20	+	+	+		+	+	o	10%+	o
caustic soda lye, hydrous	10	20	+	+	+	3%o	+	+	30%+	50%+	o
Chlorine	any	20	-	-	-		o	-	-	o	-
Chromalum, hydrous	dilute	40					+	+			20°C+
Citric acid	upto10	40	20°C+	20°C+	20°C+	3%o	+	20°C+	+	+	20°C+
Cooling liquids(DIN53521)		120	o	o	+			-			-
Copper monochloride, hydrous	saturated	20					+	+	+	+	+
Copper sulphate, hydrous	saturated	60	+	+	+		+	+	+	+	20°C+
Carbon disulphide	100	20	+	+	+		o	-	o		-
Cresol, hydrous	upto90	20	pure-	pure-			+	-	o		-
Cyclohexanol	-	20	+	+	+	o	+	-	o	-	-
Diesel fuel		85	+	+	+	20°C+	o	-	o		+
Drilling oil			+	+	+			-	o		+
Ethyl alcohol, hydrous	10	20	40Vol.-%+	40Vol.-%+	40Vol.-%+		+	+	+	+	+
Ethyl dichloride	100	20	o	o	o		-	-	-	o	-
Ethyl ether	100	20	+	+	+	o	o	-	-	-	o
Ethyl oxide	100	20	+	+	+		+	-	-	-	-
Ferric cyanide, hydrous	saturated	60	o	o	o		+	+			+
Ferrous chloride, hydrous, indifferent	10	20	+	+	+	40°Co	+	+	+	+	+
Fluorine	50	40	pure-	pure-	pure-		-	-	-	-	-
Formaldehyde, hydrous	dilute	40	pure+	pure+	pure+		40%+	20°Co	o	40%+	20°C-

\*Silikone is gaspermeable

PLASTIC MATERIALS

CHEMICAL RESISTANCE

+ resistant      o conditionally resistant      - not resistant

Reagens	Concentration %	at temp. +°C	Polyamide	Polyamide	Polyamide	Thermoplastic Polyurethane	Polypropylene	Soft PVC	Silicone	Thermoplastic Elastomer	Nitrile Butadiene rubber
			PA 6	PA 66	PA 12	PU	PP	PVC	SI*	TPE	NBR
Formic acid, hydrous	10	20	o	o	+		+	+	o	+	o
Glucose, hydrous	any	50					+	+	+		+
Hydraulic fluid, hardly inflammable		80	+	+	+		+	-	-		-
Hydraulic oil H and HL (DIN51524)		100	+	+	+			-	-		o
Hydricbromic acid ,hydrous	upto10	40	-	-	-		50%+	o	o	-	-
Hydrochloric acid, hydrous	30	20	20%-	20%-	20%-	20%o	+	10%+	10%+	10%+	o
Hydrogen	100	60	20°C+	20°C+	20°C+		+	+	+	+	20°C+
Hydrosilicofluoric acid, hydrous	upto30	20	-	-	-		+	o	-	o	o
Hydroxylamine sulphate, hydrous	upto12	30	+	+	+		+	o			+
Kerosine	100	80	+	+	+		+	-	o		+
Lactic acid, hydrous	upto90	20	10%+	10%+	10%+	3%o	+	+	+	+	+
Lubricating grease, base polyphenyester		110	+	+	+		+	o	o	-	+
Lubricating grease, base silicone oil		110	+	+	+		+	o	o	-	+
Lubricating grease, diester oil		110	o	o	+		+	o	o	-	+
Magnesium carbonate, hydrous	saturated	100					+	+	+		+
Magnesium chloride, hydrous	saturated	20	10%+	10%+	10%+		+	+	+	+	+
Mercury	pure	20	+	+	+		+	o	+	+	+
Methanol	100	20	+	+	+		50%+	o	+	+	+
Methylene chloride	100	20	o	o	o	-	o	-	-	o	-
Mineral oil			+	+	+	80°C+	20°C+	20°Co	o	-	+
Nickel chloride, hydrous	saturated	20	10%o	10%o	10%o		+	+	+		+
Nickel sulphate, hydrous	saturated	20	10%o	10%o	10%o		+	+	+		+
Nitric acid, hydrous	50	20	-	-	-	20%-	o	o	10%o	30%o	-
Nitro glycerin	dilute	20						-			
Oil and grease		20	+	+	+		o	o	o	o	+
Oilec acid	-	20	+	+	+		+	+	o	-	+
Oxalic acid, hydrous	any	20	10%o	10%o	10%o	3%o	+	+	+		o
Ozone	pure		-	-	-		o	o	+		-
Phosgene, gaseous	100	20					o	-			o
Phosphoric acid, hydrous	dilute	20	10%-	10%-	10%-	3%o	85%+	50%+	85%o	85%+	-
Phosphorus pentoxide	100	20					+	+			-
poatassium permanganate, hydrous	saturated	20					+	o	+		+
Potassium bromide, hydrous	any	20	10%o	10%o	10%+		+	+	+	+	+
Potassium chloride, hydrous	10	20	+	+	+		+	+	+	+	+
Potassium dichromate, hydrous	40	20	5%o	5%o	5%o		+	+	100%+	+	+
Potassium nitrate, hydrous	any	20	10%+	10%+	10%+		+	+	+	10%+	+
Sea water		40	+	+	+	20°C+	+	+	+	+	20°C+
Soap solution, hydrous	dilute	20	+	+	+	+	+	+	+	+	+
Sodium chlorate, hydrous	saturated	20	10%o	10%o	10%o		+	25%o	20%+	15%+	+
Sulphuric acid, hydrous	10	20	-	-	-	20%o	85%+	+	10%+	98%+	o
Tin chloride	dilute	40					+	+	o	10%+	20°C+
Toluene	100	20	+	+	+	-	o	-	-	+	-
Trichloroethylene	100	20	o	o	o		o	-	-	-	-
Urea, hydrous	upto10	40	20%+	20%+	20%+		+	+	+		+
Vinyl acetate	100	20					+	-			
Waste gas, containing carbon dioxide	any	60	+	+	+			+	+		+
Waste gas, containing carbon SO2	low	60	+	+	+		+	+	o		+
Xylene	100	20	+	+	+		o	-	-	-	-
Zinc chloride, hydrous	dilute	60	10%o	10%o	10%o		+	20°C+	+	10%+	20°C+
Zinc sulphate, hydrous	dilute	60					+	20°C+	+		20°C+

Origin : Kunststoff-Tabellen, B. Carlowitz, Carl Hanser Verlag, and others

The above mentioned data enable a preselection. However the data don't promise definite properties of the products or their suitability for a concrete application purpose. The data don't release the purchaser from checking the products' quality conformance.

PRÜFMETHODEN

FLEXA PRÜFUNGEN NACH EN 61386-23 |  
FLEXA TESTS ACC. TO EN 61386-23

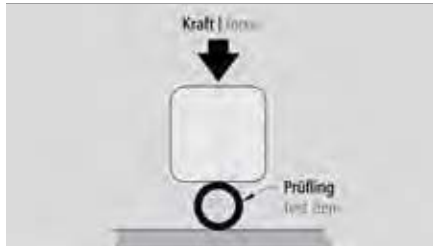

**Querdruckprüfung**  
nach Flexa Norm 1008  
Compressions test  
acc. to Flexa norm 1008

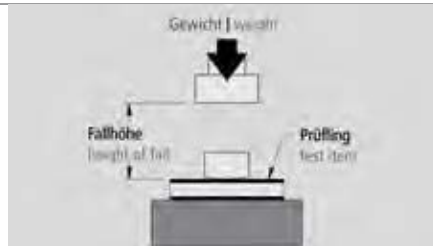

**Schlagprüfung**  
nach Flexa Norm 1008  
Impact test  
acc. to Flexa norm 1008



**Flexibilitätsprüfung | Wechselbiegeprüfung**  
nach Flexa Norm 1036  
Flexibility test | Alternate bending test  
acc. to Flexa norm 1036



**Minimale Dauergebrauchs- und Installationstemperatur**  
nach Flexa Norm 1008  
Minimum continued use and installation temperature  
acc. to Flexa norm 1008

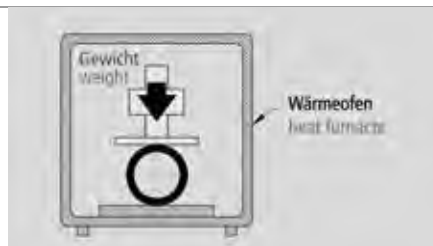

**Maximale Dauergebrauchs- und Installationstemperatur**  
nach Flexa norm 1008  
Maximum continued use and installation temperature  
acc. to Flexa norm 1008

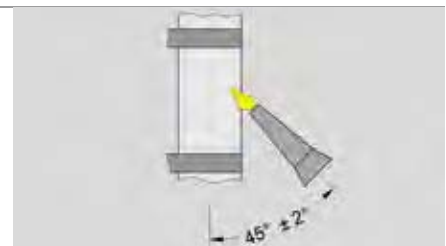

**Widerstand gegen Flammausbreitung**  
nach Flexa Norm 1008  
Resistance against flamespreading  
acc. to Flexa norm 1008

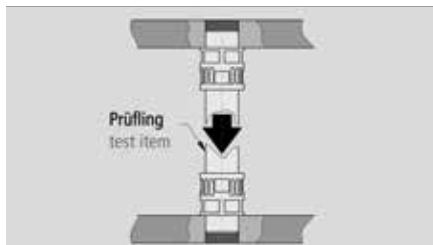

**Zugfestigkeitsprüfung | Auszugsprüfung**  
nach Flexa Norm 1008  
Tensile strength test | Pull out test  
acc. to Flexa norm 1008

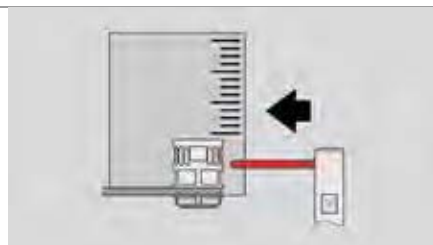

**Glühdrahtprüfung**  
nach Flexa Norm 1029  
Glow wire test  
acc. to Flexa norm 1029

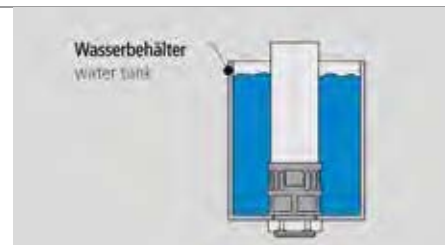

**IP Schutzartprüfung**  
nach Flexa Norm 1014  
IP protection class test  
acc. to Flexa norm 1014

EMV-TESTMETHODEN

EMC-TEST METHODS

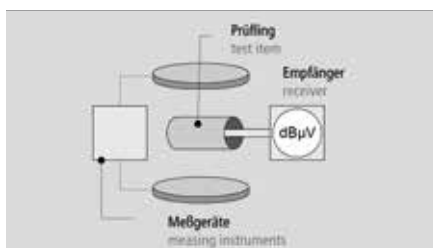

VG 95373 Teil 41 KS 06 B  
VG 95373 part 41 KS 06 B

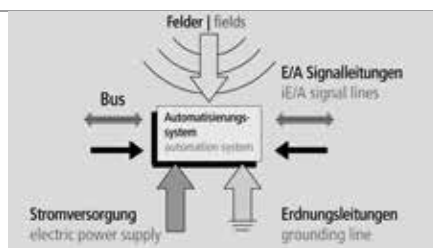

DIN VDE 0877  
Messen von Funkstörfeldstärke  
Measuring of immunity to interference

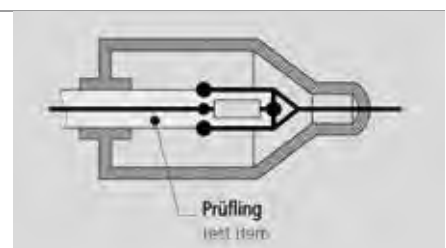

VDE 0245 Kopplungswiderstand  
VDE 0245 Surface transfer



TESTING METHODS

FLEXA STANDARD PRÜFUNGEN  
FLEXA STANDARD TESTS

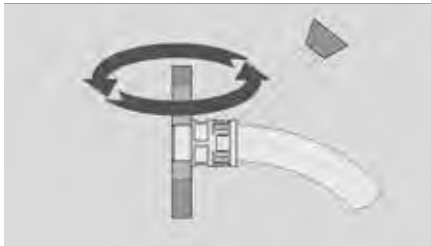

**Dynamische Schutzartprüfung**  
nach Flexa Norm 1014  
Dynamic protection class test  
acc. to Flexa norm 1014

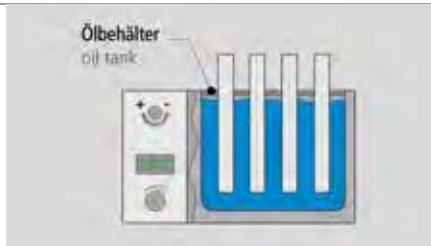

**Temperaturprüfungen**  
nach Flexa Norm 1034  
Temperature tests  
acc. to Flexa norm 1034



**Bewitterung**  
nach Flexa Norm 1034  
Outdoor weathering  
acc. to Flexa norm 1034

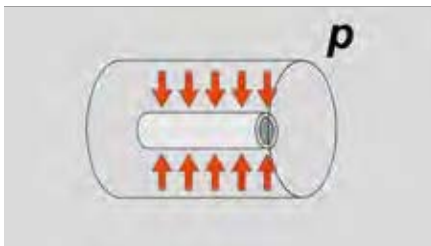

**Autoklaventest**  
nach Flexa norm 1041  
Autoclaves test  
acc. to Flexa norm 1041

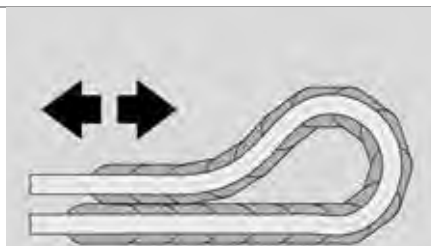

**Bewegungstest Führungsketten**  
mit integrierten Elektroschutzschläuchen  
nach Flexa Norm 1044  
Motion test guiding chain  
with integrated electrical protective tubing  
acc. to Flexa norm 1044

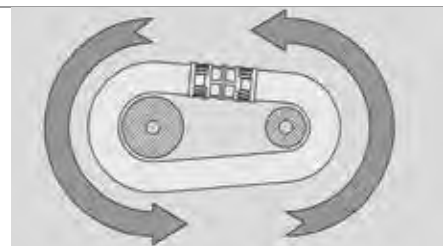

**Dauerbiegeprüfung**  
nach Flexa norm 1042  
Flexing endurance test  
acc. to Flexa norm 1042

PRÜFUNGEN NACH UL | CSA-NORMEN  
TESTS ACC. TO UL | CSA NORMS

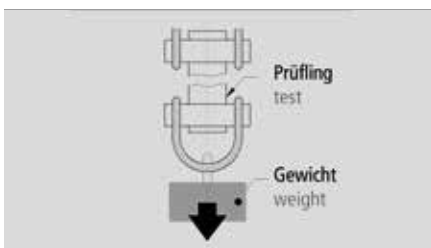

**Dehnungstest UL 360**  
Tension test UL 360

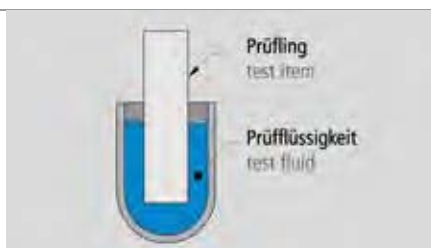

**Zink-Beschichtungstest UL 360**  
Zinc-Coating test UL 360

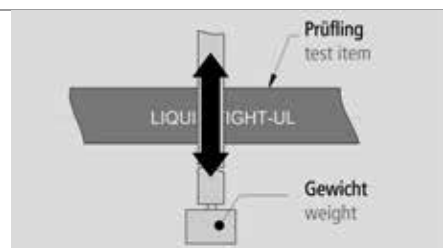

**Beschriftungstest UL 360**  
Label test UL 360

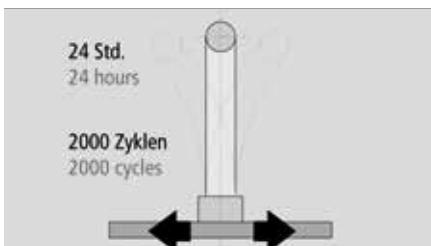

**Vibrations-Test UL 514 B**  
Vibration test UL 514 B

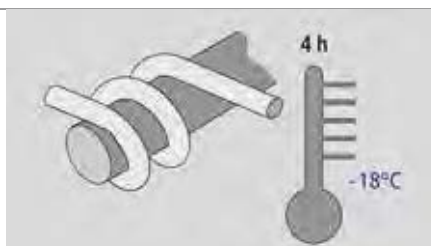

**Flexibilitäts-Test CSA-C 22,2, Nr. 227, 3-M91**  
Flexibility test CSA-C 22,2, No. 227, 3-M91

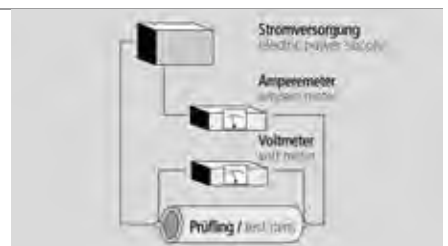

**Widerstandstest | Spannungsabfalltest UL 360**  
Resistance test and voltage drop test UL 360

## FACHGERECHTES TRENNEN

### TRENNEN UND ABLÄNGEN VON SCHLÄUCHEN ALLER ART MIT EINER BANDSÄGE PARTING AND TRIMMING OF ALL TYPES OF CONDUITS WITH A BAND SAW



Schlauch im rechten Winkel zum Sägeblatt ansetzen  
Position conduit at right angles to band saw



Schlauch mit wenig Druck durchsägen  
Cut conduit with low pressure on the conduit



Sauberer Schnitt und gebrauchsfertige Schlauchenden  
Conduit ends are clean and ready for use

### TRENNEN VON SCHLÄUCHEN MIT METALLUMFLECHTUNG MIT EINER BANDSÄGE PARTING OF METAL BRAIDED CONDUITS WITH A BAND SAW



Trennstelle ca. 2–3 x mit Metall-Klebeband umwickeln  
Bind conduit with metal adhesive tape at the cutting position 2 or 3 times



Im rechten Winkel zum Sägeblatt mit geringem Druck durchtrennen  
Position conduit at right angle to the band saw and carefully cut through the conduit



Saubere Trennung ohne Fasern durch die Umwicklung mit Metall-Klebeband  
Conduit ends are clean without splaying, due to adhesive tape binding

Planschnitt Feingezahnte Bandsäge, 4-5 mm breit, 0,6 -0,8 mm dick, 24 Zähne, mit hoher Schnittgeschwindigkeit.  
Facing cut Band saw, 4 to 5mm wide, 0.6 to 0.8 mm thick, 24 teeth, used at a high cutting speed.

### TRENNEN VON UMFLOCHTENEN SCHUTZSCHLÄUCHEN MIT EINER TRENNSCHEIBE PARTING OF PROTECTIVE BRAIDED CONDUITS WITH CUTTING DISC



Schlauch im rechten Winkel unter der Trennscheibe fixieren  
Position conduit below cutting disc (90°)



Mit geringem Druck durchtrennen Enden versäubern  
Cut through the conduit with low pressure clean ends

**TRENNEN UND ABLÄNGEN VON METALL-SCHUTZSCHLÄUCHEN MIT EINER MINI-KREISSÄGE**  
**PARTING AND TRIMMING OF PROTECTIVE METAL CONDUITS WITH A SMALL DISC SAW**



Trennschnitt in Längsrichtung des Schlauches über 1 bis 2 Schlauchgänge  
 Cut longitudinally across 2 hose covering segments

Schlauch auseinander drehen  
 Unscrew the coils

Das Ergebnis sind fachgerechte Schlauchenden  
 The result is a skilled parting

Kreissäge: Hartmetallblatt ca. 12 bis 15 mm  $\varnothing$ , ca. 25 Zähne bei Messing, ca. 50 Zähne bei Stahl, ca. 40.000 U/min. Antrieb Druckluft oder elektrisch. Die Kreissäge sowie das entsprechende Zubehör können wir gerne vermitteln.  
 Disc saw: 12 to 15 mm diameter, with carbide tipped teeth. Number of teeth: 25 on copper disc; 50 on steel disc. Disc speed: Approx. 40.000 r.p.m. Drive: Pneumatic or electric. Disc saw and accessories available on request.

**MANUELLES TRENNEN**  
**MANUAL PARTING**



**METALLSCHUTZSCHLÄUCHE**  
**PROTECTIVE METAL CONDUITS**

Metallschlauch kräftig nach innen verjüngend aufdrehen (eine Hand nach rechts, andere Hand nach links drehen)

Compress metal conduit between both hands and unwind with contra-rotating hand motions.

Mit Feinblechschere trennen, 1 bis 2 Schlauchgänge ausheben, quer zum Profil abschneiden, ausgehobene Gangenden beidrücken. Mit einer Blechschere die überstehenden Teile sauber abschneiden.  
 Cut off with snips. Uncoil one or two segments and cut off. Press in the ends and snip off the protruding corners.



**KUNSTSTOFFSCHUTZSCHLÄUCHE**  
**PROTECTIVE PLASTIC CONDUITS**

Kunststoff-Ummantelung durchschneiden  
 Cut through the plastic sheathing

Schlauch knicken und Wendel mit der Zange durchtrennen  
 Bend the conduit and cut through the helix

## PRODUKTE VON A – Z | PRODUCTS FROM A – Z

Produkt Typ product type	Seite page	Produkt Typ product type	Seite page	Produkt Typ product type	Seite page
ADK-M P PM	09.15	LKI-M P	08.27	RQG2-M N PIU	03.19
ADM-M P PM	09.14	LP (PH)	10.15	RQG3-M U	03.22
ADMf-M	09.16	Montagezange	08.37	RQK-M P	03.8
AIRflex®-GRS	06.6	MSD	08.33	RQK2-M P	03.21
AIRflex®-GRS-FOOD	06.7	Multi-FRM	03.42	RQKZ-M P	03.14
AIRflex®-K	06.5	Multi-FRM68	03.43	RQKZE-M	03.15
AIRflex®-KUW-PVC-AS	06.2	Multi-GFP	03.44	RQKZED-M	03.16
AIRflex®-KUW-EDU	06.4	Multi-WFP	03.45	RQKZP-M	03.12
AIRflex®-KUW-PU-AS	06.3	NIMS-M P	08.32	RQGR	03.50
AK	08.34	OR-M P	09.4	RQGST-M	03.24
ARAW   ARKP	10.22	PB	10.7	RQGZ-M N P	03.17
BW-M P	09.23	PB-PH	10.15	RQGZ1-M N P	03.18
Bell fitting driver	08.37	PB-L/R	10.8	RQGZ-S	03.23
BWK-M P	09.24	PB4 LV/RV	10.8	RQH   RQHG	03.51
DE-M P   DEO-M P	09.22	PB5 LV/RV	10.8	RQHD	03.51
EE	08.35	PBZ	10.7	RQHV	03.51
E EK	08.36	PH-G	10.16	RQK   RQK-PA	03.48
EEM	08.35	PH7	10.11	RQK-GW-PA	03.49
EG-M P	08.29	PH10	10.12	RQLB1 45-M N	03.36
EK	08.34	PH12	10.13	RQLB1 90-M P N	03.31
EW 45-M P	08.30	PL3	10.3	RQLG1-M P N	03.11
EW 90-M P	08.31	PL4	10.4	RQMS   RQM	03.53
EWK-M P	09.13	PL5	10.5	RQMR	03.54
EWM-M P	09.12	PS	10.6	RQMR Kabel	03.55
FDW-VA	07.7	PS (PH)	10.14	RQMR-MOVE	03.56
FFBS-PA-V0	11.8	PS-VA	07.11	RQPRO	03.43
FFEG-TPE	11.7	PSL-VA	07.11	RQS	03.52
FFEG-TPE-V0 [RAIL]	11.5	REK-M P	09.11	RQT   RQT-PA	03.46
FFEK-TPE	11.6	REM-M P	09.10	RQW-C M N P	03.37
FFEK-TPE-V0 [RAIL]	11.4	RGE-M	03.26	RQW-F	03.39
FFKEP-PA	11.10	ROHRflex®-Cutter	02.23	RQW1-M N P	03.38
FFR-AL-UL-ATEX	11.2	ROHRflex®-Slitter	02.23	RQY   RQY-PA	03.47
FFR-PA	11.3	ROHRflex® Duo PA 6	02.20	Schlauchtrennschere	08.37
FFRR-TPE-V0	11.9	ROHRflex® Duo PP	02.21	SCSRN	10.16
FLEXAgraff®-AS	04.6	ROHRflex® Multi PA 6	02.19	Separating shears	08.37
FLEXAgraff®-CU-AS	04.8	ROHRflex® Multi PA 12	02.19	SGL	08.32
FLEXAgraff®-CU-PU	05.11	ROHRflex® PA 12	02.10	SKM   SKM-Multi	09.25
FLEXAgraff®-PU-AS	05.8	ROHRflex® PA 12-D	02.11	SPR	04.2
FLEXAgraff®-PU-F	05.9	ROHRflex® PA 12-F	02.14	SPR-AS	04.2
FLEXAgraff®-SI-ASF	05.10	ROHRflex® PA 12-FD	02.15	SPR-CU-AS	04.5
FLEXAgraff®-VA	04.7	ROHRflex® PA 12-S	02.12	SPR-EDU-AS	04.4
FLEXAhightemp	07.14	ROHRflex® PA 12-SD	02.13	SPR-PA	05.4
FLEXAspiral PE   PA 12	07.12	ROHRflex® PA 12-ESD	02.16	SPR-PU-AS	05.5
FLEXAzip	02.22	ROHRflex® PA 6	02.2	SPR-PU-F	05.6
FLEXAzip Montagehilfe mounting tool	02.23	ROHRflex® PA 6-CU	02.9	SPR-PVC	05.3
FR-C M N P	09.2	ROHRflex® PA 6-D	02.3	SPR-PVC-AS	05.2
FRH-C M N P	09.3	ROHRflex® PA 6-HT	02.8	SPR-PVC-ESD	07.9
Führungsketten	10.2	ROHRflex® PA 6-L	02.5	SPR-VA-PVC	07.8
GM-M P N C	09.5	ROHRflex® PA 6-LG	02.5	SPR-VA-PU	07.10
GME-M P	09.7	ROHRflex® PA 6-LL	02.6	SPR-PVC-EDU-AS	05.7
GMK-M N P	09.6	ROHRflex® PA 6-S	02.4	SPR-VA	04.3
GMK-Duo-M	09.7	ROHRflex® PA 6-UL-SD	02.7	SRP2	10.16
Guide chains	10.2	ROHRflex® PP	02.17	STK-M P	09.18
HG-CU	07.4	ROHRflex® PU	02.18	STM-M P	09.17
HG-CU-F	07.4	RQA	03.42	TED	08.33
HG-CU-K	07.5	RQB45-M P N	03.32	Tülleneindreher	08.37
HG-EDU	07.6	RQB90-M P N	03.27	US-FOOD-M	08.28
HG-PA	07.2	RQB1 45-M N	03.35	US-M	08.2
HG-PET022	07.3	RQB1 90-M	03.30	US-P	08.5
KSK-M P	09.21	RQBK45-M P	03.33	US2-M	08.8
KSM-M P	09.20	RQBK90-M N P	03.28	USB-M	08.20
K-EDU	06.9	RQBK45DR-M	03.34	USD-M P	08.16
K-Schlauch	06.8	RQBK90DR-M N P	03.29	USDR-M	08.10
LI-M P	08.18	RQE	03.41	USK-M P	08.26
LIF-M P	08.19	RQF2-M	03.40	USW-M P	08.22
LIQUID-TIGHT-EF	05.12	RQG-C M N P	03.6	USZ-M	08.12
LIQUID-TIGHT-EF-OR	05.13	RQG-Duo-M	03.25	USZ-EX-M	08.14
LIQUID-TIGHT-FOOD	05.15	RQG1-C M P N	03.9	VBM-M P	09.8
LIQUID-TIGHT-UL-CSA	05.14	RQG1-S	03.23	WIC-M P	09.9
				Z-M	09.19

## PRODUKTE NACH ARTIKELNUMMERN | PRODUCTS SORTED BY ARTICLE NUMBER

FLEXA No	Produkt Typ product type	Farbe colour	Seite page	FLEXA No.	Produkt Typ product type	Farbe colour	Seite page
1 0131 801 0..	FDW-VA		07. 7	1 0321 000 0..	KSK-P	grau grey	0921
1 0133 900 0..	PS-VA	grau grey	07.11	1 0321 000 02..	KSK-P	schwarz black	0921
1 0133 901 0..	PSL-VA	grau grey	07.11	1 0322 M.. ...	DE-M   DEO-M	schwarz black	09.22
1 0200 101 0..	AIRflex®-K	grau grey	06. 5	1 0322 P.. ...	DE-P   DEO-P	schwarz black	09.22
1 0201 101 0..	AIRflex®-K 10 m	grau grey	06. 5	1 0330 000 0..	OR-P		09. 4
1 0205 101 0..	K-Schlauch	grau grey	06. 8	1 0330 001 0..	OR-M		09. 4
1 0206 201 0..	ROHRflex® Multi PA 6	grau grey	02.19	1 0331 000 0..	FR-NIPIC		09. 2
1 0206 202 0..	ROHRflex® Multi PA 6	schwarz black	02.19	1 0331 001 0..	FRH-NIPIC		09. 3
1 0207 201 0..	ROHRflex® Multi PA 12	grau grey	02.19	1 0333 000 0..	FR-M		09. 2
1 0207 202 0..	ROHRflex® Multi PA 12	schwarz black	02.19	1 0333 001 0..	FRH-M		09. 3
1 0220 101 0..	AIRflex®-GRS	grau grey	06. 6	1 0340 000 0..	SGL		08.32
1 0220 904 0..	AIRflex®-GRS-FOOD	blau blue	06. 7	1 0350 M.. M..	REM-M		09.10
1 0231 002 0..	ROHRflex® PP	schwarz black	02.17	1 0350 P.. P..	REM-P		09.10
1 0232 201 0..	ROHRflex® PA 6-S	grau grey	02. 4	1 0351 M.. M..	REK-M	grau grey	09.11
1 0233 201 0..	ROHRflex® PA 6	grau grey	02. 2	1 0351 P.. P..	REK-P	grau grey	09.11
1 0233 202 0..	ROHRflex® PA 6	schwarz black	02. 2	1 0352 M.. M..	REK-M	schwarz black	09.11
1 0233 209 0..	ROHRflex® PA 6-S	schwarz black	02. 4	1 0352 P.. P..	REK-P	schwarz black	09.11
1 0233 209 1..	ROHRflex® PA 6-S	schwarz black	02. 4	1 0360 M.. M..	EWM-M		09.12
1 0233 232 0..	ROHRflex® PA 6	schwarz black	02. 2	1 0360 P.. P..	EWM-P		09.12
1 0236 201 0..	ROHRflex® PA 12-S	grau grey	02.12	1 0361 M.. M..	EWK-M	grau grey	09.13
1 0236 202 0..	ROHRflex® PA 12	schwarz black	02.10	1 0361 P.. P..	EWK-P	schwarz black	09.13
1 0236 209 0..	ROHRflex® PA 12-S	orange	02.12	1 0362 M.. M..	EWK-M	grau grey	09.13
1 0236 232 0..	ROHRflex® PA 12	schwarz black	02.10	1 0362 P.. P..	EWK-P	schwarz black	09.13
1 0237 202 0..	ROHRflex® PA 6-D	schwarz black	02. 3	1 0370 M.. P..	ADM-MP		09.14
1 0237 232 0..	ROHRflex® PA 6-D	schwarz black	02. 3	1 0370 P.. M..	ADM-PM		09.14
1 0238 202 0..	ROHRflex® PA 6-UL-SD	schwarz black	02. 7	1 0371 M.. P..	ADK-MP	grau grey	09.15
1 0239 202 0..	HG-PA	schwarz black	07. 2	1 0371 P.. M..	ADK-PM	grau grey	09.15
1 0239 601 0..	HG-PET022	grau grey	07. 3	1 0380 101 ...	FFEK-TPE-VO	grau grey	11. 4
1 0239 602 0..	HG-PET022	schwarz black	07. 3	1 0380 102 202	FFR-PA	schwarz black	11. 3
1 0230 692 0..	HG-PET022 Dispenser	schwarz black	07. 3	1 0380 102 302	FFR-PA	schwarz black	11. 3
1 0241 102 0	FLEXAspiral PA 12	schwarz black	07.12	1 0380 102 ...	FFEK-TPE	schwarz black	11. 6
1 0241 602 ...	FLEXAspiral PE	schwarz black	07.13	1 0380 103 ...	FFEK-TPE-VO-RAIL	grau grey	11. 4
1 0241 605 ...	FLEXAspiral PE	transparent	07.13	1 0380 203 ...	FFEG-TPE-VO-RAIL	grau grey	11. 5
1 0242 202 0..	ROHRflex® PA 12-S	schwarz black	02.12	1 0380 110 ...	FFR-AL-UL-ATEX		11. 2
1 0242 232 0..	ROHRflex® PA 12-S	schwarz black	02.12	1 0380 120 404	FFRR-TPE-VO		11. 9
1 0243 202 0..	ROHRflex® PA 12-SD	schwarz black	02.13	1 0380 201 ...	FFEG-TPE-VO	grau grey	11. 5
1 0243 232 0..	ROHRflex® PA 12-SD	schwarz black	02.13	1 0380 202 ...	FFEG-TPE	schwarz black	11. 7
1 0249 202 0..	ROHRflex® PA 12-F	schwarz black	02.14	1 0380 302 0..	FFKEP-PA	schwarz black	11.10
1 0249 232 0..	ROHRflex® PA 12-F	schwarz black	02.14	1 0389 402 0..	FFBS-PA-VO	schwarz black	11. 8
1 0252 202 0..	ROHRflex® PA 12-FD	schwarz black	02.15	1 0410 000 0..	Tülleneindreher	Bell fitting	08.37
1 0252 232 0..	ROHRflex® PA 12-FD	schwarz black	02.15	1 0420 000 0..	Montagezange	Circlip pliers	09.37
1 0254 202 0..	ROHRflex® PA 6-HT	schwarz black	02. 8	1 0432 000 001	Schlauchtrennschere	Cutter	08.37
1 0255 202 1..	FLEXAzip	schwarz black	02.22	1 0433 000 0..	ROHRflex® Schere	Cutter	02.23
1 0258 202 0..	ROHRflex® PA 12-D	schwarz black	02.11	1 0433 001 0..	Ersatzklingen	Spare blades	02.23
1 0258 232 0..	ROHRflex® PA 12-D	schwarz black	02.11	1 0434 000 0..	ROHRflex® Slitter		02.23
1 0259 202 0..	ROHRflex® PA 12-ESD	schwarz black	02.16	1 0434 001 0..	Ersatzklinge ROHRflex® Slitter	Spare blades	02.23
1 0261 201 0..	ROHRflex® PA 6-L	grau grey	02. 5	1 0461 702 0..	ROHRflex® PA 6-CU		02. 9
1 0261 202 0..	ROHRflex® PA 6-L	schwarz black	02. 5	1 0512 100 0..	WIC-P		09. 9
1 0261 209 0..	ROHRflex® PA 6-L	orange	02. 5	1 0512 300 0..	WIC-M		09. 9
1 0261 231 0..	ROHRflex® PA 6-L	grau grey	02. 5	1 0522 000 0..	KSM-P		09.20
1 0261 232 0..	ROHRflex® PA 6-L	schwarz black	02. 5	1 0522 001 0..	KSM-M		09.20
1 0261 239 0..	ROHRflex® PA 6-L	orange	02. 5	1 0527 001 0..	VBM-M		09. 8
1 0261 242 0..	ROHRflex® PA 6-LG	schwarz black	02. 5	1 0530 000 0..	GM-P		09. 5
1 0267 201 0..	ROHRflex® PA 6-LL	schwarz grau	02. 6	1 0531 000 0..	GM-M		09. 5
1 0267 202 0..	ROHRflex® PA 6-LL	schwarz black	02. 6	1 0531 000 0..	GM-N		09. 5
1 0267 231 0..	ROHRflex® PA 6-LL	grau black	02. 6	1 0535 300 0..	Z-M		09.19
1 0267 232 0..	ROHRflex® PA 6-LL	schwarz black	02. 6	1 0541 ... ..	Schrauben RQM	Screws (RQM)	03.53
1 0269 202 0..	ROHRflex® Duo PA 6	schwarz black	02.20	1 0550 000 0..	STM-P		09.17
1 0269 202 1..	ROHRflex® Duo PA 6	schwarz black	02.20	1 0550 001 0..	STM-M		09.17
1 0270 032 0..	ROHRflex® Duo PP	schwarz black	02.21	1 0551 000 0..	STK-P	grau grey	09.18
1 0270 032 1..	ROHRflex® Duo PP	schwarz black	02.21	1 0551 000 2..	STK-P	schwarz black	09.18
1 0289 902 0..	ROHRflex® PU	schwarz black	02.18	1 0551 001 0..	STK-M	grau grey	09.18
1 0289 932 0..	ROHRflex® PU	schwarz black	02.18	1 0551 001 2..	STK-M	schwarz black	09.18
1 0308 0.. 0..	SKM   SKM-Multi		09.25	1 0560 000 0..	GME-P		09. 7
1 0309 000 0..	GMK-M	grau grey	09. 6	1 0561 000 0..	GME-M		09. 7
1 0309 000 2..	GMK-M	schwarz black	09. 6	1 0601 000 0..	EE		08.36
1 0310 000 0..	GMK-P	grau grey	09. 6	1 0601 000 021	EEM		08.35
1 0310 000 2..	GMK-P	schwarz black	09. 6	1 0607 000 0..	EW 90-M		08.31
1 0315 000 0..	BWK-P	grau grey	09.24	1 0608 000 0..	EG-M		08.29
1 0315 001 0..	BWK-M	grau grey	09.24	1 0608 000 0..	US-FOOD-M		08.28
1 0316 000 0..	GMK-N	grau grey	09. 6	1 0609 000 0..	EW 45-M		08.30
1 0316 000 0..	GMK-N	schwarz black	09. 6	1 0610 000 0..	EG-P		08.29
1 0318 000 0..	GMK-Duo-M	schwarz black	09. 7	1 0611 000 0..	EW 45-P		08.30
1 0321 001 0..	KSK-M	grau grey	09.21	1 0612 000 0..	EW 90-P		08.31
1 0321 000 02..	KSK-M	schwarz black	09.21	1 0621 000 051	LIQUID-TIGHT-UL-CSA	schwarz black	05.14

## PRODUKTE NACH ARTIKELNUMMERN

FLEXA No.	Produkt Typ product type	Farbe colour	Seite page
1 1010 101 0..	SPR		04. 2
1 1010 111 0..	SPR-AS		04. 2
1 1010 801 0..	SPR-VA		04. 3
1 1011 111 0..	SPR-AS 10 m		04. 2
1 1018 801 0..	SPR-VA Endlage	end position	04. 3
1 1019 801 1..	SPR-VA Endlage	end position	04. 3
1 1080 101 0..	FLEXAgraff®-AS		04. 6
1 1080 801 0..	FLEXAgraff®-VA		04. 7
1 2010 102 0..	SPR-PVC	schwarz black	05. 3
1 2010 111 0..	SPR-PVC-AS	grau grey	05. 2
1 2010 112 0..	SPR-PVC-AS	schwarz black	05. 2
1 2010 182 0..	SPR-VA-PVC	schwarz black	07. 8
1 2010 389 9..	SPR-VA-PU	gelb yellow	07.10
1 2010 902 0..	SPR-PVC-ESD	schwarz black	07. 9
1 2011 111 0..	SPR-PVC-AS 10 m	grau grey	05. 2
1 2011 112 0..	SPR-PVC-AS 10 m	schwarz black	05. 2
1 2013 202 0..	SPR-PA	schwarz black	05. 4
1 2030 101 0..	AIRflex®-KUW-PVC-AS	grau grey	06. 2
1 2031 101 0..	AIRflex®-KUW-PVC-AS 10 m	grau grey	06. 2
1 2040 701 0..	AIRflex®-KUW-PU-AS	metallic blaulblue	06. 3
1 2041 701 0..	AIRflex®-KUW-PU-AS 10 m	metallic blaulblue	06. 3
1 2060 112 0..	LIQUID-TIGHT-UL-CSA	schwarz black	05.14
1 2061 809 0..	FLEXAhightemp	rot red	07.14
1 2061 899 0..	Wickelband   Tape	rot red	07.15
1 2061 898 0..	Wickelband   wrapping tape	rot red	07.15
1 2080 111 0..	LIQUID-TIGHT-EF	grau grey	05.12
1 2082 102 0..	LIQUID-TIGHT-EF-OR	schwarz black	05.13
1 2083 914 0..	LIQUID-TIGHT-FOOD	blau blue	05.15
1 2130 101 0..	FLEXAgraff®-PU-AS	metallic blaulblue	05. 8
1 2131 101 0..	FLEXAgraff®-PU-AS 10 m	metallic blaulblue	05. 8
1 2133 702 0..	FLEXAgraff®-PU-F	schwarz black	05. 9
1 2140 801 0..	FLEXAgraff®-SI-ASF	grau grey	05.10
1 2210 711 0..	SPR-PU-AS	metallic blaulblue	05. 5
1 2213 702 0..	SPR-PU-F	schwarz black	05. 6
1 2540 707 0..	FLEXAgraff®-CU-PU	grün green	05.11
1 4010 111 0..	SPR-EDU-AS		04. 4
1 4011 111 0..	SPR-EDU-AS 10 m		04. 4
1 4016 701 0..	SPR-CU-AS		04. 5
1 4020 101 0..	K-EDU		06. 9
1 4050 101 0..	HG-EDU		07. 6
1 4050 101 1..	HG-EDU 10 m		07. 6
1 4050 701 0..	HG-CU		07. 4
1 4050 701 1..	HG-CU 10 m		07. 4
1 4050 702 0..	HG-CU-F		07. 4
1 4051 701 0..	HG-CU-K		07. 5
1 4050 702 0..	HG-CU-F		07. 4
1 4110 701 0..	FLEXAgraff®-CU-AS		04. 8
1 4210 101 0..	SPR-PVC-EDU-AS		05. 7
1 4230 101 0..	AIRflex®-KUW-EDU		06. 4
1 4231 101 0..	AIRflex®-KUW-EDU (10 m)		06. 4
1 5010 010 0..	LI-P		08.18
1 5010 012 0..	LI-M		08.18
1 5010 022 0..	NIMS-P		08.32
1 5010 023 0..	NIMS-M		08.32
1 5010 027 0..	BW-P		09.23
1 5010 031 0..	BW-M		09.23
1 5010 033 0..	ADMF-M		09.16
1 5010 1..	US-P		08. 6
1 5010 2..	USW-P		08.25
1 5010 3..	US-M		08. 3
1 5010 04..	US-P kleine Packung small package		08. 6
1 5010 5.. 0..	USW-M		08.23
1 5010 710 0..	LI-P kleine Packung small package		08.18
1 5010 08..	US-M kleine Packung small package		08. 4
1 5011 5.. 0..	USW-M		08.23
1 5011 1..	US-P		08. 7
1 5011 2..	USW-P		08.25
1 5011 3..	US-M		08. 4
1 5011 601 021	US-P		08. 7

FLEXA No.	Produkt Typ product type	Farbe colour	Seite page
1 5011 828. ...	US-M kleine Packung small package		08. 4
1 5012 3..	US2-M		08. 9
1 5013 3..	USDR-M		08.11
1 5014 3..	USDR-M		08.11
1 5015 1.. 0	USD-P		08.17
1 5015 3.. 0	USD-M		08.17
1 5016 3... ..	USZ-M		08.13
1 5017 3... ..	USZ-M		08.13
1 5018 3.. ...	US2-M		08. 9
1 5020 006 2..	RQMS	schwarz black	03.53
1 5020 008 2..	RQM 2 3 4	schwarz black	03.53
1 5020 010 0..	LKI-P	grau grey	08.27
1 5020 014 0..	LKI-M	grau grey	08.27
1 5020 017 2..	RQB45-N	schwarz black	03.32
1 5020 018 2..	RQB90-N	schwarz black	03.27
1 5020 019 2..	RQBK90DR-N	schwarz black	03.29
1 5020 020 0..	RQM	grau grey	03.51
1 5020 020 2..	RQM	schwarz black	03.51
1 5020 021 0..	EK	grau grey	08.34
1 5020 022 2..	RQBK90-N	schwarz black	03.28
1 5020 026 0..	RQG-P	grau grey	03. 6
1 5020 026 2..	RQG-P	schwarz black	03. 6
1 5020 027 0..	RQG-P	grau grey	03. 6
1 5020 027 2..	RQG-P	schwarz black	03. 6
1 5020 028 0..	RQW-P	grau grey	03.37
1 5020 028 2..	RQW-P	schwarz black	03.37
1 5020 029 2..	RQW-P	schwarz black	03.37
1 5020 030 0..	EEK	grau grey	08.36
1 5020 031 0..	RQGZ-M	grau grey	03.17
1 5020 031 2..	RQGZ-M	schwarz black	03.17
1 5020 032 0..	RQY-PA	grau grey	03.47
1 5020 032 2..	RQY-PA	schwarz black	03.47
1 5020 033 0..	RQY	grau grey	03.47
1 5020 033 2..	RQY	schwarz black	03.47
1 5020 034 0..	RQGZ-P	grau grey	03.17
1 5020 034 2..	RQGZ-P	schwarz black	03.17
1 5020 036 0..	RQW-M	grau grey	03.37
1 5020 036 2..	RQW-M	schwarz black	03.37
1 5020 037 0..	RQG-M	grau grey	03. 6
1 5020 037 2..	RQG-M	schwarz black	03. 6
1 5020 038 2..	RQG-N	schwarz black	03. 7
1 5020 039 2..	RQW-N	schwarz black	03.37
1 5020 041 0..	RQT-PA	grau grey	03.46
1 5020 041 2..	RQT-PA	schwarz black	03.46
1 5020 046 2..	RQG1-N	schwarz black	03.10
1 5020 047 2..	RQG2-U	schwarz black	03.20
1 5020 049 0..	RQG1-P	grau grey	03. 9
1 5020 049 2..	RQG1-P	schwarz black	03. 9
1 5020 050 0..	RQW1-P	grau grey	03.38
1 5020 050 2..	RQW1-P	schwarz black	03.38
1 5020 051 0..	RQW1-M	grau grey	03.38
1 5020 051 2..	RQW1-M	schwarz black	03.38
1 5020 052 2..	RQG-C	schwarz black	03. 7
1 5020 053 2..	RQW-C	schwarz black	03.37
1 5020 054 2..	RQG3-U	schwarz black	03.22
1 5020 055 0..	RQG1-M	grau grey	03. 9
1 5020 055 2..	RQG1-M	schwarz black	03. 9
1 5020 056 2..	RQG-N	schwarz black	03. 7
1 5020 057 2..	RQW-N	schwarz black	03.37
1 5020 058 2..	RQG1-C	schwarz black	03.10
1 5020 060 2..	RQGZ1-P	schwarz black	03.18
1 5020 062 2..	RQG1-P	schwarz black	03. 9
1 5020 063 2..	RQG1-P	schwarz black	03. 9
1 5020 064 0..	RQW-M	grau grey	03.37
1 5020 064 2..	RQW-M	schwarz black	03.37
1 5020.065.0..	RQG-M	grau grey	03. 6
1 5020 065 2..	RQG-M	schwarz black	03. 6
1 5020 066 2..	RQK	schwarz black	03.48
1 5020 067 2..	RQT	schwarz black	03.46

## PRODUCTS SORTED BY ARTICLE NUMBER

FLEXA No.	Produkt Typ product type	Farbe colour	Seite page
1 5020 071 0..	RQF2-M	grau grey	03.40
1 5020 071 2..	RQF2-M	schwarz black	03.40
1 5020 074 2..	RQGK-P	schwarz black	03. 8
1 5020 075 2..	RQGK2-P	schwarz black	03.21
1 5020 077 0..	RQW-F	grau grey	03.39
1 5020 077 2..	RQW-F	schwarz black	03.39
1 5020 078 0..	RQG2-M	grau grey	03.19
1 5020 078 2..	RQG2-M	schwarz black	03.19
1 5020 079 2..	RQG3-M	schwarz black	03.22
1 5020 080 2..	RQG2-N	schwarz black	03.19
1 5020 081 0..	RQG2-P	grau grey	03.19
1 5020 081 2..	RQG2-P	schwarz black	03.19
1 5020 082 0..	RQG1-S	grau grey	03.23
1 5020 082 2..	RQG1-S	schwarz black	03.23
1 5020 087 2..	RQBK45-P	schwarz black	03.33
1 5020 088 2..	RQBK90-P	schwarz black	03.28
1 5020 089 2..	RQB45-P	schwarz black	03.32
1 5020 090 2..	RQB90-P	schwarz black	03.27
1 5020 094 2..	RQK	schwarz black	03.46
1 5020 130 0..	USK-P	grau grey	08.26
1 5020 330 0..	USK-M	grau grey	08.26
1 5020 382 0..	RQG1-S	grau grey	03.23
1 5020 382 2..	RQG1-S	schwarz black	03.23
1 5020 430 0..	USK-P	kleine Packung small package	08.26
1 5020 710 0..	LKI-P	kleine Packung small package	08.27
1 5020 714 0..	LKI-M	kleine Packung small package	08.27
1 5020 730 0..	USK-M	kleine Packung small package	08.26
1 5020 751 2..	RQW1-M	kleine Packung small package	03.38
1 5020 755 2..	RQG1-M	kleine Packung small package	03. 9
1 5023 3.. ...	USZ-EX-M		08.15
1 5024 3.. ...	USZ-EX-M		08.15
1 5025 327 0..	USB-M		08.21
1 5025 328 0..	USB-M		08.21
1 5025 339 025	USB-M		08.21
1 5030 012 0..	RQE	grau grey	03.41
1 5030 012 2..	RQE	schwarz black	03.41
1 5030 013 0..	TED		08.33
1 5030 014 2..	AK	schwarz black	08.34
1 5030 020 0..	RQS	grau grey	03.52
1 5030 020 2..	RQS	schwarz black	03.52
1 5030 021 0..	RQA	grau grey	03.42
1 5030 021 2..	RQA	schwarz black	03.42
1 5030 025 0..	RQH	grau grey	03.51
1 5030 025 2..	RQH	schwarz black	03.51
1 5030 026 0..	RQHD	grau grey	03.51
1 5030 026 2..	RQHD	schwarz black	03.51
1 5030 027 0..	RQHV	grau grey	03.51
1 5030 027 2..	RQHV	schwarz black	03.51
1 5030 028 0..	RQHG	grau grey	03.51
1 5030 028 2..	RQHG	schwarz black	03.51
1 5030 211 5..	FLEXAzip Montagewerkzeug	Mounting tool	02.23
1 5031 0.. ...	EEM	grau grey	08.35
1 5031 028 009	EE	grau grey	08.36
1 5031 034 0..	MSD		08.33
1 5032 006 0..	Multi-GFP	grau grey	03.44
1 5032 007 0..	Multi-WFP	grau grey	03.45
1 5032 207 0..	Multi-WFP	schwarz black	03.45
1 5032 206 0..	Multi-GFP	schwarz black	03.44
1 5032 208 0..	Multi-FRM	Dichtung sealing	03.44
1 5032 211 0..	Multi-FRM68	Dichtung sealing	03.45
1 5100 0.. 0..	RQB45-M	grau grey	03.32
1 5100 0.. 2..	RQB45-M	schwarz black	03.32
1 5101 0.. 0..	RQB1 45-M	grau grey	03.35
1 5101 0.. 2..	RQB1 45-M	schwarz black	03.35
1 5102 0.. 2..	RQBK45-M	schwarz black	03.33
1 5103 0.. 0..	RQB90-M	grau grey	03.27
1 5103 0.. 2..	RQB90-M	schwarz black	03.27
1 5104 0.. 0..	RQB1 90-M	grau grey	03.30
1 5104 0.. 2..	RQB1 90-M	schwarz black	03.30

FLEXA No.	Produkt Typ product type	Farbe colour	Seite page
1 5105 0.. 2..	RQBK90-M	schwarz black	03.28
1 5107 ... 2..	RQGK-M	schwarz black	03. 8
1 5108 0 .. 2..	RQGK2-M	schwarz black	03.21
1 5109 0 .. 0..	RQGZ1-M	grau grey	03.18
1 5109 0 .. 2..	RQGZ1-M	schwarz black	03.18
1 5110 0.. 2..	RQGKZ-M	schwarz black	03.14
1 5111 0.. 2..	RQGKZE-M	schwarz black	03.15
1 5112 ... 2..	RQGKZP-M	schwarz black	03.12
1 5115 0.. 0..	RQLG1-M	grau grey	03.11
1 5115 0.. 2..	RQLG1-M	schwarz black	03.11
1 5117 0.. 0..	RQLB1 90-M	grau grey	03.31
1 5117 0.. 2..	RQLB1 90-M	schwarz black	03.31
1 5518 0.. 0..	RQLB1 45-M	grau grey	03.36
1 5518 0.. 2..	RQLB1 45-M	schwarz black	03.36
1 5121 0.. 2..	RQBK90DR-M	schwarz black	03.29
1 5121.4.. 2..	RQBK90DR-M	schwarz black	03.29
1 5126 0.. 0..	RGE-M		03.26
1 5128 0.. 2..	RQG-Duo-M	schwarz black	03.25
1 5130 0.. 2..	RQGZ-S	schwarz black	03.23
1 5131 0.. 2..	RQBK45DR-M	schwarz black	03.34
1 5131 4.. 2..	RQBK45DR-M	schwarz black	03.34
1 5133 0.. 2..	RQKZED-M	schwarz black	03.16
1 5500 0.. 2..	RQKZ-P	schwarz black	03.14
1 5515 0.. 2..	RQLG1-P	schwarz black	03.11
1 5517 0.. 2..	RQLB1 90-P	grau grey	03.31
1 5521 0.. 2..	RQBK90DR-P	schwarz black	03.29
1 5524 0.. 2..	RQPRO	schwarz black	03.43
1 5601 0.. 2..	RQGR	schwarz black	03.50
1 5602 0.. 2..	RQK-PA	schwarz black	03.48
1 5604 0.. 2..	RQGST-M	schwarz black	03.24
1 5605 0.. 2..	RQMR	schwarz black	03.54
1 5606 0.. 2..	RQMR Kabel	schwarz black	03.55
1 5607 0.. 2..	RQMR-MOVE	rot red	03.56
1 5609 0.. 2..	RQK-GW-PA	schwarz black	03.49
1 5701 0.. 2..	RQB1 45-N	schwarz black	03.35
1 5703 0.. 2..	RQB90-N	schwarz black	03.27
1 5704 0.. 2..	RQGZ-N	schwarz black	03.17
1 5705 0.. 2..	RQGZ1-N	schwarz black	03.18
1 5715 0.. 2..	RQLG1-N	schwarz black	03.11
1 5717 0.. 2..	RQLB1 90-N	schwarz black	03.31
1 5718 0.. 2..	RQLB1 45-N	schwarz black	03.36
1 5727 0.. 2..	RQW1-N	schwarz black	03.38
1 5801 0.. 0..	LIF-P		08.19
1 5801 3.. 0..	LIF-M		08.19
1 5801 4.. 0..	LIF-P	kleine Packung small package	08.19
1 5801 8.. 0..	LIF-M	kleine Packung small package	08.19
1 6023 031 0..	PL3	schwarz black	10. 3
1 6024 0.. 0..	PL4	schwarz black	10. 4
1 6025 ... 0..	PL5	schwarz black	10. 5
1 6091 ... 0..	PH10	schwarz black	10.12
1 6096 ... 0..	PH12	schwarz black	10.13
1 6097 ... 0..	PH7	schwarz black	10.11
1 6127 150 000	ARAW-15		10.21
1 6127 150 001	ARAW-15-G		10.22
1 6127 150 002	ARAW-15-A		10.21
1 6127 150 003	ARAW-15-V		10.21
1 6129 150 000	ARKP		10.22
1 614. 000 000	PS	schwarz black	10. 6
1 615. 0.. 000	PBZ	schwarz black	10. 7
1 615. 000 002	PB	schwarz black	10. 7
1 615. 000 1..	PB-L	schwarz black	10. 8
1 615. 000 2..	PB-R	schwarz black	10. 8
1 6154 000 ...	PB4 LV/RV	schwarz black	10. 8
1 6155 000 ...	PB5 LV/RV	schwarz black	10. 8
1 615. 000 009	PB-PH	schwarz black	10.15
1 6170 000 ...	SRP2	schwarz black	10.16
1 627. ... 000	SCSRN	schwarz black	10.16
1 6316. ... . ...	LP (PH)	schwarz black	10.15
1 632. 000 000	PS (PH)	schwarz black	10.14
1 640. 000 000	PH-G	schwarz black	10.16





WICHTIGE INFORMATIONEN

Empfehlungen zu Anwendungsgebieten, Einsatzbereichen, Produkten oder Produktkombinationen erfolgen von FLEXA nach bestem Wissen und bisherigen Erkenntnissen und Erfahrungen. Der Einsatz von FLEXA Produkten für spezifische Anwendungen muss vom Benutzer unbedingt überprüft werden.

Eine Produkthaftung seitens FLEXA erlischt, wenn FLEXA Produkte zusammen mit Fremdprodukten eingesetzt oder kombiniert werden.

Alle veröffentlichten Texte, Produktabbildungen, Zeichnungen und Tabellen dürfen nicht ohne die Zustimmung von FLEXA kopiert, bearbeitet oder verändert werden. Eine Verwendung bedarf dem schriftlichen Einverständnis von FLEXA.

Unsere Lieferbedingungen finden Sie auf den nachfolgenden Seiten.

Druckfehler, Fehler in technischen Zeichnungen, Irrtum und technische Änderungen behalten wir uns vor.

Technische Zeichnungen, Zertifikate, Zulassungen und Ergebnisse des FLEXA-eigenen Prüflabors werden auf Anfrage gerne von uns zur Verfügung gestellt.

3D Download  
<http://flexa.partcommunity.com>

IMPORTANT INFORMATION

Recommendations for any areas of applications, products, or product combinations are issued to the best of FLEXA's knowledge and experience. The user is requested to check applicability of FLEXA products to specific applications and purposes prior to the use of the particular products.

Product liability by FLEXA will be ineffective when FLEXA products are combined with or applied together with non-FLEXA products.

All documentation, illustrations, and charts published are subject to copyright and must not be copied, changed, used, or modified without prior approval in writing by FLEXA.

For our General Terms of Trade and Delivery please see the next pages.

FLEXA will not be held liable for typographical or other errors and incorrect drawings. Technical modifications are subject to change without prior notice.

Technical drawings, certificates, authorizations, and results by the FLEXA lab will be provided upon request.

3D download  
<http://flexa.partcommunity.com>

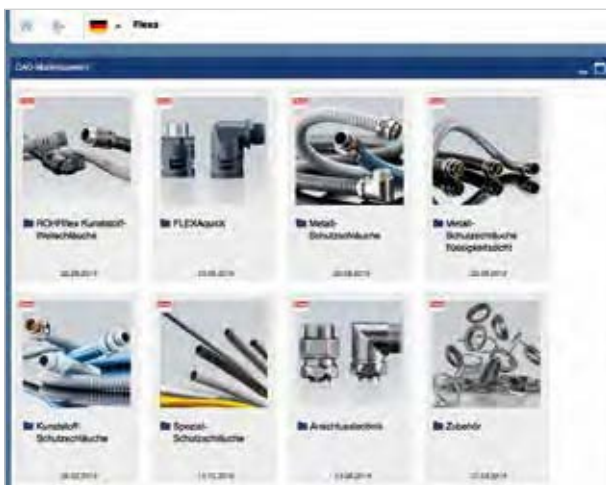

Folgen Sie uns auf | follow us on:





## I. ALLGEMEINE BESTIMMUNGEN

1. Diese Allgemeinen Lieferbedingungen gelten nur gegenüber Unternehmern im Sinne des § 14 BGB. Für den Umfang der Lieferung oder Leistungen (im folgenden: Lieferung) sind die beiderseitigen schriftlichen Erklärungen maßgebend. Allgemeine Geschäfts- oder Einkaufsbedingungen des Bestellers gelten jedoch nur insoweit, als FLEXA ihnen ausdrücklich schriftlich zugestimmt hat. Dies gilt auch im Falle der vorbehaltlosen Vertragsdurchführung.

2. Alle Angebote von FLEXA sind freibleibend. Ebenso sind technische Beschreibungen und sonstige Angaben in Angeboten, Prospekten und sonstigen Informationen zunächst unverbindlich. Alle Aufträge und Vereinbarungen werden erst durch schriftliche Bestätigung oder durch Absenden der Ware verbindlich.

3. An Kostenvoranschlägen, Zeichnungen und anderen Unterlagen (im folgenden: Unterlagen) behält sich FLEXA die eigentums- und urheberrechtlichen Verwertungsrechte uneingeschränkt vor. Die Unterlagen dürfen nur nach vorheriger Zustimmung von FLEXA Dritten zugänglich gemacht werden.

4. Teillieferungen sind zulässig, soweit sie dem Besteller zumutbar sind.

5. Diese Allgemeinen Lieferbedingungen gelten auch für alle zukünftigen Rechtsgeschäfte zwischen FLEXA und dem Besteller.

## II. TECHNISCHE ANGABEN, ABMESSUNG, LIEFERMENGE, TOLERANZEN

1. Technische Angaben, z. B. über Maße, Gewichte und Leistungszahlen, Abbildungen und Zeichnungen, sind nur im Rahmen üblicher technischer Toleranzen maßgebend, soweit sie nicht ausdrücklich als verbindlich bezeichnet werden.

2. Werden bei größeren Schlauchmengen keine Längenmaße für Einzelschläuche vorgeschrieben, bleibt FLEXA das jeweilige Längenmaß freigestellt.

3. Bei größeren Mengen und Sonderanfertigungen bleiben FLEXA Mehr- oder Minderlieferungen von 10 % vorbehalten. Bei Lieferungen von Schläuchen in abgepassten Fixlängen behält sich FLEXA eine Längentoleranz von plus/minus 5 % vor, sofern nicht Längen in zusammengeschobenen Maßen vorgeschrieben sind.

4. Bei allen Schläuchen können aus produktionstechnischen Gründen bis zu 20 % der Liefermengen in gestückten bzw. ungeraden Ringlängen geliefert werden.

5. Alle Metallschläuche werden in gestreckter Länge berechnet. Sonstige Toleranzen sowie die jeweiligen technischen Daten sind in den Katalogen angegeben.

## III. PREISE UND ZAHLUNGSBEDINGUNGEN

1. Die Preise verstehen sich ab Werk ausschließlich Verpackung zuzüglich der jeweils geltenden gesetzlichen Umsatzsteuer.

2. Zahlungen sind frei Zahlstelle von FLEXA zu leisten.

3. Sofern nichts anderes vereinbart, hat der Besteller den Kaufpreis innerhalb von 10 Tagen nach Zugang der Rechnung von FLEXA ohne Abzug zu entrichten.

4. Falls der Besteller seiner Zahlungspflicht am Fälligkeitstage nicht nachkommt, darf FLEXA – ohne Aufgabe etwaiger weiterer ihr zustehender Rechte und Ansprüche - nach ihrer Wahl:

a) den Vertrag kündigen oder weitere Lieferungen an den Besteller aussetzen.

5. FLEXA's Messing|Kupfererzeugnisse sind auf der Messing|Kupfernotierungsbasis von 128 bis 153 P für MS 58 I kalkuliert. Je 12,5 P nach oben (ausgehend von 153) und unten (ausgehend von 128) bedeuten 5% Auf- oder Abschlag. Maßgebend für die Notierung ist der Tag des Vertragsabschlusses.

6. Der Besteller kann nur mit solchen Forderungen aufrechnen, die unbestritten oder rechtskräftig festgestellt sind.

7. Schuldet der Besteller FLEXA mehrere Zahlungen gleichzeitig, wird – sofern der Besteller keine Tilgungsbestimmung getroffen hat – zunächst die fällige Schuld unter mehreren fälligen Schulden die jeweils ältere Schuld getilgt.

8. Der Abzug von Skonto bedarf einer gesonderten schriftlichen Vereinbarung. Sofern ein Skontoabzug vereinbart ist, ist der Abzug von Skonto bei neuen Schulden unzulässig, solange eine ältere Schuld nicht getilgt ist.

9. Schecks und Wechsel werden von FLEXA nur nach vorheriger Vereinbarung und zahlungshalber angenommen. Die Zahlung gilt erst mit der Einlösung als erfolgt. Etwaige Diskontspesen und Zinsen sind FLEXA zu ersetzen.

10. Kommt der Besteller mit einer Zahlung in Verzug, so werden alle - auch gestundete - Forderungen aus laufenden Geschäften sofort fällig, es sei denn, der Besteller leistet durch Beibringung einer Bank- oder Sparkassenbürgschaft Sicherheit. Dies gilt auch im Falle einer Zahlungseinstellung des Bestellers, eines Antrages auf Eröffnung eines Vergleichs- oder Insolvenzverfahrens über sein Vermögen, von Einzel-Zwangsvollstreckungsmaßnahmen in sein Vermögen oder eines Wechsel- oder Scheckprotestes gegen ihn.

## IV. EIGENTUMSVORBEHALT

1. Die Gegenstände der Lieferung (Vorbehaltsware) bleiben Eigentum von FLEXA bis zur Erfüllung sämtlicher ihr gegen den Besteller aus der Geschäftsverbindung zustehenden Ansprüche. Soweit der Wert aller Sicherungsrechte, die FLEXA zustehen, die Höhe aller gesicherten Ansprüche um mehr als 20 % übersteigt, wird FLEXA auf Wunsch des Bestellers einen entsprechenden Teil der Sicherungsrechte freigeben.

2. Während des Bestehens des Eigentumsvorbehaltes ist dem Besteller eine Verpfändung oder Sicherungsübereignung untersagt und die weitere Veräußerung nur Wiederverkäufern im gewöhnlichen Geschäftsgang und nur unter der Bedingung gestattet, dass der Wiederverkäufer von seinem Kunden Bezahlung erhält oder den Vorbehalt macht, dass das Eigentum auf den Kunden erst übergeht, wenn dieser seine Zahlungsverpflichtungen erfüllt hat.

3. Bei Pfändungen, Beschlagnahmen oder sonstigen Verfügungen oder Eingriffen Dritter hat der Besteller FLEXA unverzüglich zu benachrichtigen.

4. Bei Pflichtverletzungen des Bestellers, insbesondere bei Zahlungsverzug, ist FLEXA zum Rücktritt und zur Rücknahme berechtigt, der Besteller ist zur Herausgabe verpflichtet. In der Rücknahme bzw. der Geltendmachung des Eigentumsvorbehalts oder der Pfändung der Vorbehaltsware durch FLEXA liegt kein Rücktritt vom Vertrag vor, es sei denn, FLEXA hätte dieses ausdrücklich erklärt.

5. Erweiterter Eigentumsvorbehalt: Verarbeitung oder Umbildung unserer Ware durch den Besteller findet ausschließlich für FLEXA statt. Bei Verarbeitung mit anderen, der FLEXA nicht gehörenden Waren steht FLEXA Miteigentum an der neuen Sache zu im Verhältnis des Rechnungsendbetrages der Vorbehaltsware von FLEXA zum Anschaffungspreis der anderen verarbeiteten Waren zur Zeit der Verarbeitung. Für die neue Sache gilt im übrigen die Regelung zur Vorbehaltsware entsprechend. Bei untrennbarer Vermischung der Vorbehaltsware von FLEXA mit anderen Gegenständen steht FLEXA das Miteigentum an der neuen Sache zu im Verhältnis des Rechnungsendbetrages der Vorbehaltsware von FLEXA zum Anschaffungspreis der anderen vermischten Gegenstände zur Zeit der Vermischung. Der Besteller verwahrt das Allein- oder Miteigentum für FLEXA.

6. Verlängerter Eigentumsvorbehalt: Der Besteller ist befugt, die Vorbehaltsware von FLEXA im ordnungsmäßigen Geschäftsgang weiter zu veräußern. Sämtliche hieraus entstehenden Forderungen gegen Dritte tritt der Besteller hiermit im voraus an FLEXA ab, und zwar in Höhe des jeweiligen Rechnungswertes einschließlich Mehrwertsteuer. Ungeachtet dieser Abtretung bleibt der Besteller weiterhin zur Einziehung der Forderungen berechtigt. Auf Verlangen hat der Besteller die abgetretenen Forderungen nebst deren Schuldnern gegenüber FLEXA bekannt zu geben und alle für eine Forderungseinziehung benötigten Angaben und Unterlagen FLEXA zur Verfügung zu stellen. Auf besonderes Verlangen von FLEXA macht der Besteller den betreffenden Drittschuldnern Mitteilung von der Abtretung an FLEXA.

## V. FRISTEN FÜR LIEFERUNGEN; VERZUG

1. Die Einhaltung von vereinbarten Fristen für Lieferungen setzen den rechtzeitigen Eingang sämtlicher vom Besteller zu liefernden Unterlagen, erforderlicher Genehmigungen und Freigaben, insbesondere von Plänen sowie die Einhaltung der vereinbarten Zahlungsbedingungen und sonstigen Verpflichtungen durch den Besteller voraus. Werden diese Voraussetzungen nicht rechtzeitig erfüllt, so verlängern sich die Fristen angemessen; dies gilt nicht, wenn FLEXA die Verzögerung zu vertreten hat.

2. Ist die Nichteinhaltung der Fristen auf höhere Gewalt, z. B. Mobilmachung, Krieg, Aufruhr oder auf ähnliche Ereignisse, z. B. Streik, Aussperrung, unabwendbare und schwerwiegende Betriebsstörungen zurückzuführen, verlängern sich die Fristen angemessen.

3. Kommt FLEXA in Verzug, kann der Besteller - sofern er glaubhaft macht, dass ihm hieraus ein Schaden entstanden ist - eine Entschädigung für jede vollendete Woche des Verzuges von je 0,5 %, insgesamt jedoch höchstens 5 % des Preises für den Teil der Lieferung verlangen, der wegen des Verzuges nicht in zweckdienlichen Betrieb genommen werden konnte.

4. Sowohl Schadensersatzansprüche des Bestellers wegen Verzögerung der Lieferung als auch Schadensersatzansprüche statt der Leistung, die über die in Ziffer V. Nr. 3 genannten Grenzen hinausgehen, sind in allen Fällen verzögerter Lieferung, auch nach Ablauf einer FLEXA etwa gesetzten Nachfrist, ausgeschlossen. Dies gilt nicht, soweit in Fällen des Vorsatzes, der groben Fahrlässigkeit oder wegen der Verletzung des Lebens, des Körpers oder der Gesundheit zwingend gehaftet wird; eine Änderung der Beweislast zum Nachteil des Bestellers ist hiermit nicht verbunden. Vom Vertrag kann der Besteller im Rahmen der gesetzlichen Bestimmungen nur zurücktreten, soweit die Verzögerung der Lieferung von FLEXA zu vertreten ist.

5. Der Besteller ist verpflichtet, auf Verlangen von FLEXA innerhalb einer angemessenen Frist zu erklären, ob er wegen der Verzögerung der Lieferung vom Vertrag zurücktritt und/oder Schadensersatz statt der Leistung verlangt oder auf die Lieferung besteht.

6. Werden Versand oder Zustellungen auf Wunsch des Bestellers um mehr als einen Monat nach Anzeige der Versandbereitschaft verzögert, kann dem Besteller für jeden angefangenen Monat Lagergeld in Höhe von 0,5 % des Preises der Gegenstände der Lieferung, höchstens jedoch insgesamt 5 %, berechnet werden. Der Nachweis höherer oder niedrigerer Lagerkosten bleibt den Vertragsparteien unbenommen.

## VI. GEFAHRÜBERGANG

Die Gefahr geht auch bei frachtfreier Lieferung wie folgt auf den Besteller über:

a) Soweit die Ware nicht an die Geschäftsräume von FLEXA ausgeliefert wird, geht die Gefahr über im Zeitpunkt der Übergabe oder, wenn der Besteller sich Annahmeverzug befindet, in dem Zeitpunkt, in dem FLEXA die Übergabe der Ware anbietet.

b) Soweit die Ware an die Geschäftsräume von FLEXA ausgeliefert wird („ex works“, Incoterms 2020), geht die Gefahr über in dem Zeitpunkt, in dem FLEXA den Besteller darüber informiert, dass die Ware zur Abholung bereit steht.

**VII. ENTGEGENNAHME**

Lieferungen sind, auch wenn sie unerhebliche Mängel aufweisen, vom Besteller entgegenzunehmen.

**VIII. SACHMÄNGEL**

Für Sachmängel haftet FLEXA wie folgt:

1. Alle diejenigen Teile oder Leistungen sind nach Wahl von FLEXA unentgeltlich nachzubessern, neu zu liefern oder neu zu erbringen, die innerhalb der Verjährungsfrist - ohne Rücksicht auf die Betriebsdauer - einen Sachmangel aufweisen, sofern dessen Ursache bereits im Zeitpunkt des Gefahrübergangs vorlag.
2. Sachmängelansprüche verjähren in 12 Monaten. Dies gilt nicht, soweit das Gesetz gemäß den §§ 438 Abs. 1 Nr. 2 (Bauwerke und Sachen für Bauwerke), 479 Abs. 1 (Rückgriffsanspruch) und 634a Abs. 1 Nr. 2 BGB (Baumängel) längere Fristen vorschreibt.
3. Der Besteller hat Sachmängel gegenüber FLEXA unverzüglich schriftlich zu rügen.
4. Bei Mängelrügen dürfen Zahlungen des Bestellers in einem Umfang zurückgehalten werden, die in einem angemessenen Verhältnis zu den aufgetretenen Mängeln stehen. Der Besteller kann Zahlungen nur zurückhalten, wenn eine Mängelrüge geltend gemacht wird, über deren Berechtigung kein Zweifel bestehen kann. Erfolgte die Mängelrüge zu Unrecht, ist FLEXA berechtigt, die ihr entstandenen Aufwendungen vom Besteller ersetzt zu verlangen.
5. Zunächst ist FLEXA stets Gelegenheit zur Nacherfüllung innerhalb angemessener Frist zu gewähren.
6. Schlägt die Nacherfüllung fehl, kann der Besteller – unbeschadet etwaiger Schadensersatzansprüche gemäß Ziffer XI. – vom Vertrag zurücktreten oder die Vergütung mindern.
7. Mängelansprüche bestehen nicht bei nur unerheblicher Abweichung von der vereinbarten Beschaffenheit, bei nur unerheblicher Beeinträchtigung der Brauchbarkeit, bei natürlicher Abnutzung oder bei Schäden, die nach dem Gefahrübergang infolge fehlerhafter oder nachlässiger Behandlung, übermäßiger Beanspruchung, ungeeigneter Betriebsmittel, mangelhaften Arbeiten oder aufgrund besonderer äußerer Einflüsse entstehen, die nach dem Vertrag nicht vorausgesetzt sind, sowie bei nicht reproduzierbaren Softwarefehlern. Werden vom Besteller oder von Dritten unsachgemäß Änderungen oder Instandsetzungsarbeiten vorgenommen, so bestehen für diese und die daraus entstehenden Folgen ebenfalls keine Mängelansprüche.
8. Ansprüche des Bestellers wegen der zum Zwecke der Nacherfüllung erforderlichen Aufwendungen, insbesondere Transport-, Wege-, Arbeits- und Materialkosten, sind ausgeschlossen, soweit die Aufwendungen sich erhöhen, weil der Gegenstand der Lieferung nachträglich an einen anderen Ort als die Niederlassung des Bestellers verbracht worden ist.
9. Gesetzliche Rückgriffsansprüche des Bestellers gegen FLEXA bestehen nur insoweit, als der Besteller mit seinem Abnehmer keine über die gesetzlichen Mängelansprüche hinausgehenden Vereinbarungen getroffen hat. Für den Umfang des Rückgriffsanspruchs des Bestellers gegen FLEXA gilt ferner Ziffer VIII. Nr. 8 entsprechend.
10. Für Schadensersatzansprüche gilt im übrigen Ziffer XI. (Sonstige Schadensersatzansprüche). Weitergehende oder andere als die in dieser Ziffer VIII. geregelten Ansprüche des Bestellers gegen FLEXA und deren Erfüllungsgehilfen wegen eines Sachmangels sind ausgeschlossen.

**IX. GEWERBLICHE SCHUTZRECHTE UND URHEBERRECHTE; RECHTSMÄNGEL**

1. Sofern nicht anders vereinbart, ist FLEXA verpflichtet, die Lieferung lediglich im Land des Lieferorts frei von gewerblichen Schutzrechten und Urheberrechten Dritter (im Folgenden: Schutzrechte) zu erbringen. Sofern ein Dritter wegen der Verletzung von Schutzrechten durch von FLEXA gelieferte, vertragsgemäß genutzte Produkte gegen den Besteller berechnete Ansprüche erhebt, haftet FLEXA gegenüber dem Besteller innerhalb der in Ziffer VIII. Nr. 2 bestimmten Frist wie folgt:
  - a) FLEXA wird nach ihrer Wahl auf ihre Kosten entweder ein Nutzungsrecht für das Produkt erwirken, das Produkt so ändern, dass das Schutzrecht nicht verletzt wird oder das Produkt austauschen. Ist dies FLEXA nicht zu angemessenen Bedingungen möglich, stehen dem Besteller die gesetzlichen Rücktritts- oder Minderungsrechte zu.
  - b) Die Pflicht von FLEXA zur Leistung von Schadensersatz richtet sich nach Ziffer XI.
  - c) Die vorstehend genannten Verpflichtungen von FLEXA bestehen nur dann, wenn der Besteller FLEXA über die von Dritten geltend gemachten Ansprüche unverzüglich schriftlich verständigt, eine Verletzung nicht anerkennt und FLEXA alle Abwehrmaßnahmen und Vergleichsverhandlungen vorbehalten bleiben. Stellt der Besteller die Nutzungen des Produkts aus Schadensminderungs- oder sonstigen wichtigen Gründen ein, ist er verpflichtet, den Dritten darauf hinzuweisen, dass mit der Nutzungseinstellung kein Anerkenntnis einer verbunden ist.
2. Ansprüche des Bestellers sind ausgeschlossen, soweit er die Schutzrechtsverletzung zu vertreten hat.
3. Ansprüche des Bestellers sind ferner ausgeschlossen, soweit die Schutzrechtsverletzungen durch spezielle Vorgaben des Bestellers, durch eine von FLEXA nicht vor-aussehbare Anwendung oder dadurch verursacht wird, dass das Produkt vom Besteller verändert oder zusammen mit nicht von FLEXA gelieferten Produkten eingesetzt wird.
4. Im Falle von Schutzrechtsverletzungen gelten für die in Ziffer IX. Nr. 1. a) geregelten Ansprüche des Bestellers im übrigen die Bestimmungen der Ziffer VIII. Nr. 4, 5 und 9 entsprechend.

5. Bei Vorliegen sonstiger Rechtsmängel gelten die Bestimmungen der Ziffer VIII. entsprechend.

6. Weitergehende oder andere als die in dieser Ziffer IX. geregelten Ansprüche des Bestellers gegen FLEXA und deren Erfüllungsgehilfen wegen eines Rechtsmangels sind ausgeschlossen.

**X. PFLICHTVERLETZUNG IN FORM DER UNMÖGLICHKEIT, VERTRAGSANPASSUNG**

1. Wird FLEXA die ihr obliegende Lieferung aus einem von ihr zu vertretenden Grunde unmöglich, ist der Besteller berechtigt, Schadensersatz statt der Leistung zu verlangen. Jedoch beschränken sich die Schadensersatzansprüche des Bestellers auf 10 % des Wertes desjenigen Teils der Lieferung, der wegen der Unmöglichkeit nicht in zweckdienlichen Betrieb genommen werden kann. Dies gilt nicht, soweit in Fällen des Vorsatzes, der groben Fahrlässigkeit oder wegen der Verletzung des Lebens, des Körpers oder der Gesundheit zwingend gehaftet wird; eine Änderung der Beweislast zum Nachteil des Bestellers ist hiermit nicht verbunden. Das Recht des Bestellers zum Rücktritt vom Vertrag bleibt unberührt.
2. Sofern unvorhersehbare Ereignisse im Sinne von Ziffer V. Nr. 2 die wirtschaftliche Bedeutung oder den Inhalt der Lieferung erheblich verändern oder auf den Betrieb von FLEXA erheblich einwirken, wird der Vertrag unter Beachtung von Treu und Glauben angemessen angepasst. Soweit dies wirtschaftlich nicht vertretbar ist, steht FLEXA das Recht zu, vom Vertrag zurückzutreten. Will FLEXA von diesem Rücktrittsrecht Gebrauch machen, so hat FLEXA dies nach Erkenntnis der Tragweite des Ereignisses unverzüglich dem Besteller mitzuteilen, und zwar auch dann, wenn zunächst mit dem Besteller eine Verlängerung der Lieferzeit vereinbart war.

**XI. SONSTIGE HAFTUNGS- UND SCHADENSERSATZANSPRÜCHE**

1. Eine etwaige anwendungstechnische Beratung seitens FLEXA erfolgt nach bestem Wissen, befreit den Besteller aber nicht von der Prüfung der Eignung dieser Beratung für die beabsichtigten Verfahren und Zwecke. Die Verantwortung hinsichtlich Eignung und bestimmungsgemäßer Verwendung der Produkte von FLEXA liegt beim Besteller. Jede Haftung von FLEXA in Verbindung mit anwendungstechnischer Beratung ist ausgeschlossen.
2. Schadens- und Aufwendungsersatzansprüche des Bestellers (im Folgenden: Schadensersatzansprüche), gleich aus welchem Rechtsgrunde, insbesondere wegen Verletzung von Pflichten aus dem Schuldverhältnis und aus unerlaubter Handlung, sind ausgeschlossen.
3. Dies gilt nicht, soweit zwingend gehaftet wird, z.B. nach dem Produkthaftungsgesetz, in Fällen des Vorsatzes, der groben Fahrlässigkeit, wegen der Verletzung des Lebens, des Körpers oder der Gesundheit, wegen der Verletzung wesentlicher Vertragspflichten. Der Schadensersatz für die Verletzung wesentlicher Vertragspflichten ist jedoch auf den vertragstypischen, vorhersehbaren Schaden begrenzt, soweit nicht Vorsatz oder grobe Fahrlässigkeit vorliegt oder wegen Verletzung des Lebens, des Körpers oder der Gesundheit gehaftet wird. Eine Änderung der Beweislast zum Nachteil des Bestellers ist mit den vorstehenden Regelungen nicht verbunden.
4. Soweit dem Besteller nach dieser Ziffer XI. Schadensersatzansprüche zustehen, verjähren diese mit Ablauf der für Sachmängelansprüche geltenden Verjährungsfrist gemäß Ziffer VIII. Nr. 2.

**XII. GERICHTSSTAND; ANWENDBARES RECHT**

1. Allgemeiner Gerichtsstand ist, wenn der Besteller Kaufmann ist, bei allen aus dem Vertragsverhältnis mittelbar oder unmittelbar sich ergebenden Streitigkeiten der Sitz von FLEXA. FLEXA ist jedoch auch berechtigt, am Sitz des Bestellers zu klagen.
2. Für die vertraglichen Beziehungen gilt Deutsches Recht unter Ausschluss des Übereinkommens der Vereinten Nationen über die Verträge über den internationalen Warenkauf (CISG).

**XIII. SCHLUSSBESTIMMUNGEN**

1. Diese Bedingungen bleiben auch bei rechtlicher Unwirksamkeit einzelner Punkte in ihren übrigen Teilen verbindlich. Sollten Bestimmungen ganz oder teilweise unwirksam sein oder werden, so soll an deren Stelle eine Bestimmung treten, die dem wirtschaftlichen Zweck der unwirksamen Bestimmung möglichst nahe kommt.
2. Die Rechte des Bestellers aus dem Schuldverhältnis sind nicht übertragbar.

**FLEXA GmbH & Co Produktion und Vertrieb KG**

Sitz: Hanau, Registergericht: AG Hanau, HRA 4421

Persönlich haftende Gesellschafterin FLEXA Management GmbH

Sitz: Hanau, Registergericht: AG Hanau, HRB 7145

Geschäftsführer: Dipl.-Kfm. Markus Stenger

Assessor jur. Christoph Stenger

Druckfehler, Irrtum und technische Änderungen vorbehalten.

## I. GENERAL TERMS AND CONDITIONS

1. These General Terms of Delivery shall solely apply to businesses according to the spirit of §14 of the Civil German Code. The extent of the supplies or services (herein referred to as "Supplies") shall be defined through the written stipulations signed by both parties. General Terms and Conditions or Purchase Terms of the Purchaser shall apply only where explicitly accepted and approved in writing by FLEXA. This also applies in the case of unconditional performance of contract.
2. All offers by FLEXA are subject to alteration. Also, technical descriptions and other information provided in quotations, product literature, and other agreements are not binding for the time being. All orders and agreements will become effective and binding upon written confirmation or upon dispatch of the goods.
3. For preliminary estimates, drawings, and other documents (herein referred to as "Documents"), FLEXA reserves all rights, rights of ownership, copyrights, and rights of exploitation without any limitation. The Documents must not be provided to a third party without prior approval by FLEXA.
4. Partial Supplies shall be admissible when acceptable for the Purchaser.
5. These General Terms of Delivery shall also apply to all future legal transactions between FLEXA and the Purchaser.

## II. TECHNICAL DATA, DIMENSIONS, QUANTITIES DELIVERED, TOLERANCES

1. Technical data such as dimensions, weights, performance numbers, illustrations, and drawings shall be binding only within the scope of common technical tolerances unless explicitly called binding.
2. If larger quantities of hoses are ordered and no linear measures are requested for the individual hoses, the respective linear measure is up to FLEXA.
3. In the case of orders for larger quantities and tailor-made products, FLEXA reserves the right for excessive and short deliveries of 10%. FLEXA reserves the right for a length tolerance of 5% upon delivery of hoses in measured fixed lengths unless lengths in compressed dimensions are ordered.
4. For all hoses, up to 20% of the quantities ordered can be delivered in cut or non-linear ring lengths due to production-related reasons, if required.
5. All metal hoses will be charged on the basis of extended length. Any other tolerances as well as particular technical data will be stated in the catalogues.

## III. PRICES AND TERMS OF PAYMENT

1. Prices shall be quoted ex works (EXW). They exclude packing and value-added tax (VAT) payable under the applicable law.
2. Payments shall be made free at FLEXA's paying office.
3. The Purchaser shall pay the invoice amount for the Supplies without any reductions to FLEXA within 10 days after receipt of the invoice unless stipulated to the contrary.
4. If the Purchaser fails to fulfil his obligation to pay on the due date, regardless any other rights or claims, FLEXA shall be entitled to:
  - a.) terminate the contract or suspend any further deliveries to the Purchaser; or
5. Brass and copper products made by FLEXA are calculated on the basis of the brass/copper quotations of 128 to 153 p for MS 58 I. Every 12,5 p higher (starting from 153) and lower (starting from 128) will result in a 5% surcharge and reduction respectively. The decisive quotation is the quotation of the date of the conclusion of the contract.
6. The Purchaser is entitled to set off only such claims which have been determined undisputed or legally binding.
7. If there are several amounts overdue for payment on the part of the Purchaser at the time, the due debt or the older debt among several debts has to be settled first unless the Purchaser has arranged for any redemption agreement.
8. Any deduction of prompt-payment discount is subject to prior written agreement. If there has been arranged for a prompt-payment discount agreement, the deduction of any such cash discount will not be applicable until any former debts have been redeemed.
9. Cheques and bills of exchange for payment purposes will be accepted by FLEXA only subject to prior agreement. Payment shall be regarded effected not before redemption. Possible discount charges and interest will have to be reimbursed for FLEXA.
10. If the Purchaser fails to keep to a deadline for payment, all accounts receivable – even accounts receivable due to current transactions – will be due for immediate payment unless the Purchaser provides for a security note of a bank. This also applies to the Purchaser if any composition proceedings, insolvency proceedings, or enforcement proceedings have been filed against the Purchaser's assets, or if a bill of exchange or cheque is protested against the Purchaser.

## IV. RETENTION OF TITLE

1. The items of Supplies (Secured Goods) shall remain the property of FLEXA until each and every claim against the Purchaser to which FLEXA is entitled under this business relation has been duly satisfied. If the total value of all security rights of FLEXA exceeds the value of all secured claims by more than 20%, FLEXA shall release a corresponding part of 2.

For the duration of the retention of title, the Purchaser is prohibited the security rights on the Purchaser's request. From giving the items of Supplies in pledge or as security, and resale shall be permissible only to resellers in the ordinary course of business and only on condition that the reseller receives payment from his customer or retains title so that the property is transferred to the customer only after fulfillment of his obligation to pay.

3. In the case of seizure or other acts of interventions by a third party, FLEXA shall be immediately informed thereof in writing by the Purchaser.
4. In cases of non-performance of contractual obligations by the Purchaser, especially in the case of a delay in payment, FLEXA shall be entitled to take back the goods, and the Purchaser shall be obliged to return the purchased goods. The taking back, the assertion of the retention of title, or the seizure of the Secured Goods by FLEXA does not mean termination of the contract except if expressly stated by FLEXA.
5. Processing or modifying our goods by the Purchaser has exclusively to take place at FLEXA's. In the case of combining FLEXA goods with non-FLEXA goods through processing, FLEXA shall be entitled to claim for a proportionate share in ownership based on the ratio of the total invoice amount for the FLEXA Secured Goods to the purchase price of the other goods charged at the point of time of combining FLEXA goods with the non-FLEXA goods. The new product will be subject to the agreements related to Secured Goods accordingly. If the combined product consisting of FLEXA Secured Goods and other goods cannot be separated, FLEXA shall be entitled to claim for the proportionate share in ownership regarding the new product based on the ratio of the total invoice amount for the FLEXA Secured Goods to the purchase price of the other goods in the combined product charged at the point of time of the combination process of the goods. The Purchaser shall hold in custody sole ownership or part-ownership on behalf of FLEXA.
6. The Purchaser shall be entitled to resell FLEXA Secured Goods in the ordinary course of business. All claims resulting from such course of business against a third party shall herewith be transferred to FLEXA by the Purchaser beforehand according to the corresponding invoice value including VAT. Regardless such transfer of claims, the Purchaser shall be kept entitled to collect such claims. Upon request, the Purchaser has to announce to FLEXA the claims transferred and the corresponding debtors and to provide FLEXA with full information and all documents required for a collection of claim. Upon special request by FLEXA, the Purchaser shall inform the third-party debtor about the transfer of claim to FLEXA.

## V. TIME FOR DELIVERY, DELAY

1. Observance of the stipulated time for delivery is conditional upon the timely receipt of all documents, permits required, necessary releases, especially of plans to be provided by the Purchaser, as well as fulfillment of the agreed terms of payment and other obligations by the Purchaser. Unless these conditions are fulfilled on time, the time for delivery will be extended accordingly except where FLEXA is responsible for the particular delay.
2. If non-observance of the time for delivery is due to force majeure such as mobilization, war, riot, or similar events such as strike, lockout, or any other non-predictable or grave operational breakdowns, such time shall be extended accordingly.
3. If FLEXA is responsible for a delay in delivery, the Purchaser who can establish credibly that he suffered a loss from such delay may claim agreed compensation of 0.5% for every completed week of delay, but in no event shall the aggregate of such compensation exceed a total of 5% of the purchase price of that part of the Supplies which could not be put to the intended use due to the delay.
4. Purchaser's claims for compensation justified due to a delay in delivery and claims due to non-performance of services which exceed the limits as specified in Clause V. paragraph 3 above shall be excluded in all cases even after expiry of an extension of time that may have been granted to FLEXA. This exclusion shall not apply where in cases of willful misconduct, gross negligence, or any harm to life, body, or health there is a legally binding liability. No change in the burden of proof to the detriment of the Purchaser is involved. The Purchaser may cancel the contract within the framework of legal regulations only if the delay in delivery was caused by FLEXA.
5. Upon FLEXA's request, the Purchaser is committed to making a statement within a reasonable period of time whether he has canceled the contract due to the delay in delivery and / or he is going to claim compensation for the service or if he insists on delivery of the goods.
6. If, upon the Purchaser's request, dispatch or delivery are delayed for more than one month after readiness for dispatch has been announced, the Purchaser may be charged storage costs for each month thereafter to the amount of 0.5% of the price for the goods to be supplied, but in no event shall the aggregate storage charges exceed a total of 5% of the price. The contractual parties are at liberty to furnish proof of higher or lower storage costs.

## VI. TRANSFER OF RISK

1. Risk of damage or of loss of the Supplies shall pass to the Purchaser
  - a.) in the case of Supplies to be delivered otherwise than at FLEXA's premises, at the time of delivery or, if the Purchaser wrongfully fails to take as follows even in the case of delivery carriage paid: delivery of the Supplies, at the time when FLEXA has tendered delivery of the goods;

b.) in the case of Supplies to be delivered at FLEXA's premises "ex works", Incoterms 2020, at the time when FLEXA notifies the Purchaser that the goods are available for collection.

## VII. OBLIGATION TO ACCEPT DELIVERY

Deliveries, even with minor defects, have to be accepted by the Purchaser.

## VIII. WARRANTY FLEXA SHALL BE HELD LIABLE FOR DEFECTS OF QUALITY AS FOLLOWS:

1. FLEXA shall, at his opinion and expense, repair, replace or newly provide any parts or services which are subject to any defect of quality within the period of limitation regardless the operating period of such parts or services, if the cause for such defect was already provided at the point of time of transfer of risk.
2. Warranty claims are subject to a limitation period of 12 (twelve) months. This does not apply for cases when legal regulations demand extended periods according to §438, para. 1, no. 2 (buildings and buildings-related items), §479 para. 1 (claim under a right of recourse), and §634a para. 1 no. 2 German Civil Code (structural defects).
3. The Purchaser has to notify FLEXA about any such defects of quality in writing immediately.
4. In the case of notification of defects, Purchaser's payments may be withheld in reasonable proportion of the noticed defect. The Purchaser can withhold payments only if the legitimacy of the asserted complaint can be established beyond doubt. If legitimacy of the complaint cannot be established, FLEXA shall be entitled to claim compensation from the Purchaser for the expenses incurred.
5. FLEXA shall first be given adequate time and opportunity to remedy the defect.
6. If the defect fails to be remedied, the Purchaser shall have the right to cancel the contract or to reduce the purchase price. This cancellation or reduction does not affect any other possible claims for compensation as stated in Clause XI. below.
7. Warranty does not cover minor discrepancies in agreed quality, insignificant reduction of operability, natural wear and tear, or damage arising after the transfer of risk due to faulty or negligent handling, excessive strain, unsuitable equipment, defective workmanship, particular external influences not assumed under the contract, or non-reproducible software errors. Warranty does not cover any modifications or repairs carried out improperly by the Purchaser or by a third party.
8. Any Purchaser's claims concerning expenses, especially transportation-related costs, labour costs, travelling expenses, and material-related costs, required due to the remedy of defects shall be excluded if such expenses will incur as the subject-matter of the delivery has been forwarded to a place other than the Purchaser's branch.
9. Any legal claim under a right of recourse of the Purchaser against FLEXA shall be effective only when the Purchaser has not agreed with his customer on any terms and conditions exceeding the legal claims due to a defect of quality. Furthermore, for the extent of a purchaser's claim under a right of recourse against FLEXA, Clause VIII. paragraph 8 shall be effective.
10. For any compensation claims, Clause XI. (Further Liability) shall be effective. Except as provided in this Clause VIII., any other warranty claims of the Purchaser against FLEXA and against FLEXA's agent shall be excluded.

## IX. INDUSTRIAL PROPERTY RIGHTS AND COPYRIGHT; LEGAL IMPERFECTION IN TITLE

1. FLEXA is committed to providing Supplies free of any industrial property rights and copyright of a third party (hereinafter called Property Rights) only in the country of the place of delivery unless stipulated to the contrary. If a third party, because of an infringement of Property Rights by products furnished by FLEXA and used in conformity with this contract, asserts legitimate claims against the Purchaser, FLEXA shall be held liable to the Purchaser within the period as stipulated in Clause VIII. paragraph 2 above as follows:
  - a.) At his own option and expense, FLEXA shall either obtain a right to use the Supplies, modify the Supplies so as not to infringe the Property Rights, or replace the Supplies. If this is not feasible to FLEXA on acceptable terms, the Purchaser is entitled to apply the legal rights of cancellation and the legal rights to a reduction in price due to a defect in the article purchased.
  - b.) FLEXA's obligation to pay damages is subject to Clause XI. below.
  - c.) FLEXA's aforesaid obligations shall exist only on condition that the Purchaser immediately notifies FLEXA in writing of the claims asserted by a third party, that he does not acknowledge an infringement, and that all countermeasures and settlement negotiations are reserved to FLEXA. If the Purchaser stops using the product to reduce damage or for other important reasons, he shall be obliged to inform the third party that the suspended use does not mean acknowledgement of an infringement of Property Rights.
2. Claims of the Purchaser shall be excluded if the Purchaser is responsible for an infringement of Property Rights.
3. Claims of the Purchaser shall also be excluded if the infringement of Property Rights was caused by specific demands of the Purchaser, by a use of the product not foreseeable by FLEXA, or by the product being altered by the Purchaser or being used together with products not provided by FLEXA.

4. In the case of any infringement of Property Rights concerning the claims of the Purchaser as stipulated in Clause IX. paragraph 1, a) the agreements stipulated in Clause VIII. paragraphs 4, 5, and 9 shall be effective accordingly.

5. In the case of other legal imperfection in title, the agreements of Clause VIII. shall be effective accordingly.

6. Further claims or any other claims regarding legal imperfection in title as those stated in this Clause IX. of the Purchaser against FLEXA or against FLEXA's agent shall be excluded.

## X. IMPOSSIBILITY OF PERFORMANCE, CONTRACT ADAPTION

1. If it is impossible for FLEXA to carry out the Supplies for reasons for which it is responsible, the Purchaser shall be entitled to claim damages instead of the service. However, the Purchaser's claim for damages shall be limited to 10% of the value of that part of the Supplies which, owing to the impossibility, cannot be put to the intended use. This shall not apply where in cases of willful misconduct, of gross negligence, or of harm to life, body, or health, there is a legally binding liability. No change in the burden of proof to the detriment of the Purchaser shall be involved, and the Purchaser's right to terminate the contract shall remain unaffected.

2. Where unforeseeable events as described in Clause V, paragraph 2 substantially change the economic importance or the contents of the Supplies or considerably affect FLEXA's business, the contract shall be adapted accordingly with due regard to the principle of good faith. Where this is economically not reasonable, FLEXA shall have the right to terminate the contract. If FLEXA intends to make use of this right of termination, FLEXA shall notify the Purchaser in writing immediately after becoming aware of the significance of the event. This shall apply even where at first an extension of the delivery time had been agreed with the Purchaser.

## XI. FURTHER LIABILITY

1. Any possible application-related advice shall be given by FLEXA to the best of its knowledge and shall not liberate the Purchaser from checking applicability of such advice regarding the intended procedures and purposes. Responsibility concerning suitability and intended applicability of the FLEXA products is upon the Purchaser. Any liability of FLEXA in conjunction with such application-related advice given by FLEXA shall be excluded.
2. Any claims for damages of the Purchaser (hereinafter referred to as Claims) regardless of whether they are based on any violation of obligations resulting from the relationship under the law of obligations and from unauthorized action or on any other legal reasons shall be excluded.
3. This exclusion shall not apply where e.g. under the product liability law or in cases of willful misconduct or of gross negligence, due to harm to life, body, or health, or due to the fundamental non-performance of contractual obligations there is a legally binding liability. However, liability for damages arising from the fundamental non-performance of contractual obligations shall be limited to the foreseeable damage normally covered by the contract except in cases of willful misconduct, gross negligence, or harm to life, body, or health. This limitation does not imply any change of the burden of proof to the detriment of the Purchaser.
4. If the Purchaser is entitled to claim for damages according to this Clause XI., such claims will be subject to limitation according to the period of limitation for claims due to defects of quality as stated in Clause VIII. paragraph 2.

## XII. PLACE OF JURISDICTION AND APPLICABLE LAW

1. If the Purchaser is a businessman, the place of jurisdiction for all disputes arising directly or indirectly out of the contract shall be the place of FLEXA's premises. However, FLEXA shall also be entitled to file an action at the place of the Purchaser's premises.
2. All contractual relations shall be governed by German Law not including the United Nations Conventions on Contracts for the International Sale of Goods (CISG).

## XIII. FINAL TERMS

1. If any part of this contract becomes invalid or ineffective for some reason, the rest of this contract shall remain fully effective and shall not be affected by this partial ineffectiveness. The part fully or partially ineffective shall be substituted by an agreement which comes closest to the economic purpose of the ineffective part.
2. All rights of the Purchaser arising from the relationship under the law of obligations are non-transferable.

### FLEXA GmbH & Co Produktion und Vertrieb KG,

Sitz: Hanau Registergericht: AG Hanau, HRA 4421

Persönlich haftende Gesellschafterin FLEXA Management GmbH

Sitz: Hanau, Registergericht: AG Hanau, HRB 7145

Geschäftsführer: Dipl.-Kfm. Markus Stenger  
Assessor jur. Christoph Stenger

Errors, misprints and technical modifications excepted.





