

AGRO Kabelverschraubungen AGRO Cable Glands

Für professionelle Kabeleinführungen.
For professional cable entries.

28



Progress® . Syntec® . EMV . Ex . Flanschwinkel . Zubehör
Progress® . Syntec® . EMC . Ex . Flanged elbows . Accessories

 **AGRO**
... your quality-connection



Professionelle Lösungen von AGRO für die sichere Kabeleinführung

Progress® Kabelverschraubungen bieten ein umfangreiches Sortiment aus Kunststoff, Messing oder rostfreiem Stahl A2 / A4 und sind bewährte Helfer für die fachgerechte Kabeleinführung in Industrieanlagen. Die herausragende Kompressionstechnik sorgt für eine hohe Dichtigkeit und eine äusserst kabelschonende Zugentlastung.

AGRO Progress® Kabelverschraubungen aus Metall können mit Dichteinsätzen aus einem speziellem TPE bestückt werden. In dieser Ausführung sind sie zertifiziert nach EN 45545 sowie NFPA 130.

Progress® EMV-Kabelverschraubungen aus Messing sorgen für eine niederimpedante Verbindung zwischen Schirmgeflecht und Metallgehäuse bei einer gleichzeitig sicheren Kabeleinführung.

Progress® Ex-Kabelverschraubungen aus Kunststoff oder Messing sorgen auch in explosionsgefährdeten Bereichen für eine sichere Kabeleinführung.

Syntec® Kabelverschraubungen aus Kunststoff oder Messing sind die optimale Lösung für Ihre täglichen Installations-Aufgaben. Die einzigartige Lamellentechnik garantiert immer eine praxisgerechte Kabeleinführung, bei hervorragender Zugentlastung.

Professional solutions made by AGRO for a safe cable entry

Progress® cable glands made of synthetics, nickel-plated brass or stainless steel A2 / A4 are proven devices for professional cable entry in industrial plants. The excellent compression technology ensures tight seals and strain relief which is exceptionally easy on cables. Progress® cable glands made of metal are certified for railway applications according to EN 45545 and NFPA 130.

Progress® EMC cable glands made of brass ensure a low-impedance connection between the braided shield and the metal housing while maintaining secure cable entry.

Progress® Ex cable glands made of synthetics or brass ensure secure cable entry even in potentially explosive environments.

Syntec® cable glands made of synthetics or brass are the optimal solution for your daily installation tasks. The unique lamellar technology always guarantees cable entry with excellent strain relief.



Alle weiterführenden Informationen zu Produkten, Systemlösungen und Kommunikationsmedien finden Sie aktuell auf unserer Internetseite **www.agro.ch** oder in der AGRO App.

Please find additional information about products, system solutions and communication media on our website **www.agro.ch** or by means of the AGRO App.



Der einzigartige **Produktfinder**: Finden Sie die passende Kabelverschraubung durch Eingabe des Kabel-Durchmessers.

The unique **product finder**: Find the right cable gland quickly and easily by entering the cable diameter.

CAD-Daten in allen gängigen Formaten.

Von nahezu allen Kabelverschraubungen kann die 3D-Produktansicht eingeblendet werden. Hier bieten wir Ihnen den besonderen Service, die jeweiligen Daten in allen gängigen CAD-Formaten sich per Email zusenden zu lassen.

Die 3D-Ansicht und die Bestellmöglichkeit für die CAD-Daten können Sie über den Navigationspunkt „CAD Ansicht“ in der Produkt-Einzelansicht im Navigationsmenü unter den Produktdaten aufrufen.

CAD-data in all current formats.

For almost all cable glands, a 3D view can be displayed. 3D CAD data may be requested and will be sent via email in all current formats.

You have the possibility to display a 3D view or to order CAD data when you choose a specific item and click on the navigation bar "CAD view". You will find this bar at the bottom of the product specifications.

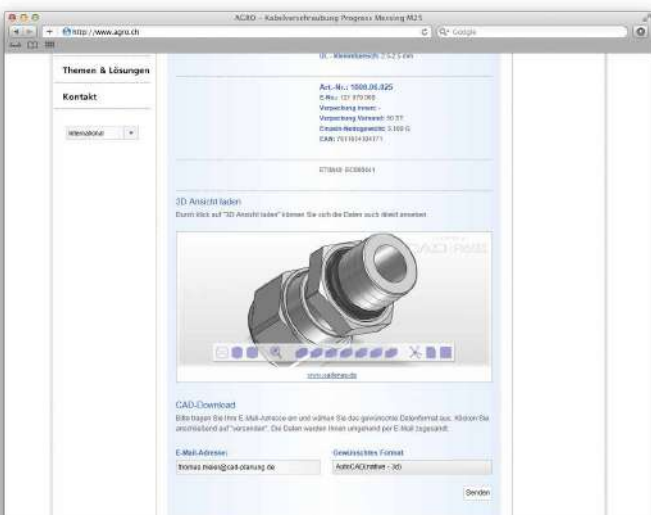

Produktübersicht Product overview

	<i>Kabelverschraubungen Progress® Messing Cable glands Progress® nickel-plated brass</i>	<i>Kabelverschraubungen Progress® nickel-plated brass Cable glands Progress® stainless steel A2 / A4</i>	<i>Spezielle Kabelverschraubungen und Kabeleinführungen Messing cable entries nickel-plated brass</i>	<i>EMV Kabelverschraubungen und EMC cable glands Special Ex cable glands Progress®</i>	<i>Ex Kabelverschraubungen Progress® Messing Ex cable glands nickel-plated brass and Kombi-Schlauchverschraubungen Progress® Messing mit integrierter Kabelverschraubung Combination conduit brass or synthetic with integrated cable glands</i>	<i>Kabelverschraubungen Progress® Messing Synthetic cable gland Kabelverschraubungen Progress® nickel-plated brass Synthetic cable glands Progress®</i>	<i>Spezielle Kabelverschraubungen Syntec® Kunststoff Kabeleinführungen Messing, Kunststoff Special cable glands and cable entries synthetic</i>
Ausführung / Version							
Kompressionstechnik Compression technology	•	•	•	•	•	•	•
Lamellentechnik Lamellar technology	-	-	-	-	-	-	•
Gewinde / Thread							
Anschlussgewinde metrisch Entry thread metric	•	•	•	•	•	•	•
Anschlussgewinde Pg Entry thread Pg	•	•	•	•	•	•	•
Anschlussgewinde NPT Entry thread NPT	•	-	-	-	•	-	•
Anschlussgewinde Gasrohr Entry thread gas pipe	•	-	-	-	•	-	-
Kurzes Anschlussgewinde Short entry thread	•	-	•	•	•	-	•
Langes Anschlussgewinde Long entry thread	•	•	•	•	•	•	-
Dichteinsatz / Sealing insert							
für Rundkabel for round cables	•	•	•	•	•	•	•
für Flachkabel for flat cables	•	-	-	-	-	A	-
für mehrere Kabel for several cables	•	A	-	-	•	A	-
TPE/NBR-Dichteinsatz (bis 100° C) TPE/NBR sealing insert (up to 100°C)	•	•	•	•	•	•	•
FPM-Dichteinsatz (bis 200° C) FPM sealing insert (up to 200°C)	•	•	-	•	-	-	-
EPDM Dichteinsatz KTW W270 EPDM sealing insert KTW W 270	-	•	-	-	-	-	-
Spezial TPE für EN 45545 Special TPE for EN 45545	•	•	•	•	-	•	A
Technische Besonderheiten / Technical features							
Knickschutz Antikink	•	-	-	•	-	-	•
Biegeschutz Bending protection	•	-	•	-	•	-	-
Externe Zugentlastung External strain relief	•	-	•	•	•	-	-
Für Schlauchanschluss For conduit connecting	•	-	-	-	-	•	-
Material / Material							
Polyamid Polyamide	-	-	-	-	-	-	•
Polyamid glasfaserverstärkt Polyamide fibre-glass reinforced	-	-	-	-	-	•	-
Messing vernickelt Nickel-plated brass	•	-	•	•	•	-	•
rostfreier Stahl A2 Stainless steel A2	-	•	-	-	•	-	-
rostfreier Stahl A4 Stainless steel A4	-	•	-	-	•	-	-

A = auf Anfrage / upon request

	Kabelverschraubungen Progress® Messing Cable glands Progress® nickel-plated brass	 15 - 57	1
	Kabelverschraubungen Progress® rostfreier Stahl A2 / A4 Cable glands Progress® stainless steel A2 / A4	 58 - 66	
	Spezielle Kabelverschraubungen und Kabeleinführungen Messing Special cable glands and cable entries nickel-plated brass	 67 - 83	3
	EMV Kabelverschraubungen Progress® Messing EMC cable glands Progress® nickel-plated brass	 84 - 107	
	Kabelverschraubungen Progress® Messing nach EN 45545 Cable glands nickel-plated brass according to EN 45545	 108 - 111	5
	Ex Kabelverschraubungen Messing oder Kunststoff Ex cable glands nickel-plated brass or synthetic	 112 - 157	
	Kombi-Schlauchverschraubungen Messing mit integrierter Kabelverschraubung Combination conduit glands nickel-plated brass with integrated cable gland	 158 - 171	7
	Kabelverschraubungen Progress® Kunststoff Synthetic cable glands Progress®	 172 - 183	
	Kabelverschraubungen Syntec® Messing und Kunststoff Cable glands Syntec®, nickel-plated brass or synthetics	 184 - 193	9
	Spezielle Kabelverschraubungen und Kabeleinführungen Kunststoff Special cable glands and cable entries synthetic	 194 - 199	
	Zubehör zu Kabelverschraubungen Kunststoff oder Metall AGROflex Geflechschläuche Accessories for cable glands synthetic and metal AGROflex Braided sleeveings	 200 - 239	11
	Zusatzinformationen / Sonderlösungen Additional information	 240 - 282	



Ulrich Kaiser
KAISER GmbH & Co. KG

Burkard Kaiser
Geschäftsführer / CEO
KAISER GmbH & Co. KG

Die KAISER Gruppe, ein Familienunternehmen in der dritten Generation, setzt seit jeher auf Fortschritt und Tradition. Als Innovationsführer im Bereich von Elektroinstallationsprodukten und Kabeleinführungen wollen wir für unsere Kunden mit starken Ideen und Lösungen der Branche stets einen Schritt voraus sein. Qualifizierte, erfahrene Mitarbeiterinnen und Mitarbeiter sind dabei der Garant für die hohe Qualität der KAISER Gruppe. Unsere Partner im Fachhandwerk und -handel sowie in der Industrie können auf unsere Innovationskraft für die Märkte von heute und morgen vertrauen. Dies gilt auch für den kundennahen Service und die schnelle Lieferfähigkeit, die eine starke Elektromarke auszeichnen.

The KAISER Group, a family-run company in its third generation, has always placed emphasis on progress and tradition. As a leading innovator in the area of electrical installation products and cable entries, our goal is to continuously be a step ahead for the benefit of our customers through powerful ideas and solutions in this sector. In this regard, our qualified, experienced employees are the guarantee of the high quality you can expect from KAISER. Our partners in the trades and professional retailers as well as throughout industry can place their trust in our innovative power, which allows us to address the markets of today and tomorrow. The same is also true for our customer-oriented service and fast delivery times, aspects which mark a truly strong brand of electrical products.



AGRO
Hunzenschwil, Schweiz

AGRO
Hunzenschwil, Switzerland

Seit 1953, also seit mehr als 60 Jahren, entwickelt und fertigt AGRO vom Standort Hunzenschwil (Schweiz) aus qualitativ hochwertige Produkte und Systeme zur Einführung und Verlegung von Kabeln für die Maschinenindustrie, für den Anlagen- und Apparatebau sowie für die professionelle Elektroinstallation in Gebäuden aller Art. AGRO gehört seit 2002 zur KAISER-Unternehmensfamilie. Die Synergien, die wir aus den Unternehmen ziehen, kommen Ihnen national und international zu Gute.

Since 1953, for more than 60 years, AGRO has been developing and manufacturing high-quality products and systems for the installation and entry of cables in the machine industry, as well as for plant engineering and construction, equipment manufacturing and professional electrical installation in buildings of all kinds. Headquartered in Hunzenschwil, Switzerland, AGRO has been part of the KAISER group since 2002. Our customers benefit from the resulting synergies both in the domestic market and abroad.

Gemeinsam Zukunft gestalten. Creating the future together.

Die Marken KAISER, AGRO, HELIA und ATTEMA bieten Ihnen immer die marktgerechte Installationslösung und unterstützen Sie so effektiv bei Ihren täglichen Aufgaben. Durch die kontinuierliche, zukunftsorientierte Produktinnovation sind Sie mit den vier starken Marken stets auf dem neuesten Stand der Technik – heute und morgen.

The KAISER, AGRO, HELIA and ATTEMA brands consistently offer you installation solutions which meet the needs of the market and thereby effectively support you in your daily work. Through their continuous future-oriented product innovations, these four strong brands provide assurance that you are always at the state of the art – today and tomorrow.

KAISER Hauptsitz / headquarters
Schalksmühle, Deutschland
Schalksmühle, Germany



ATTEMA
Gorinchem, Niederlande
Gorinchem, Netherlands



HELIA
Bornem, Belgien
Bornem, Belgium





Im Verkehrswesen kommt es vor allem auf den sicheren Halt der Zuleitung an. Die in der Bahntechnik verwendeten Progress®-Kabelverschraubungen lockern sich trotz hoher Rüttelbelastungen nicht. Daher ermöglichen sie eine einwandfreie Strom- und Signalübertragung im gesamten Schienenfahrzeug. Es sind zertifizierte Dichteinsätze für Schienenfahrzeuge nach EN 45545 und NFPA 130 verfügbar.

For **transportation**, a secure grip on the feed line is vital. The Progress® cable glands used in railway technology do not become loose, despite high vibrating loads. This results in perfect power and signal transmission throughout the train. There are certified sealing inserts available for railway applications according to EN 45545 and NFPA 130.



Messing oder Kunststoff Syntec® Kabelverschraubungen sind die ideale Lösung für vielfältige **tägliche Aufgaben**. Die einzigartige patentierte Lamellentechnik klemmt das Kabel auf schonende Art und Weise und garantiert eine sichere Kabeleinführung mit hervorragender Zugentlastung

Nickel-plated brass or synthetic Syntec® cable glands represent the optimal solution for a wide range of **daily tasks**. The patented, unique lamellar technology clamps the cable smoothly and guarantees practical cable entry with outstanding strain relief.



Durch Staub und Abgase entsteht ein beträchtliches Mass an chemischer Belastung in **Tunneln**. Diese erfordert den Einsatz von rostfreien und säurebeständigen Kabelverschraubungen aus Stahl A4 mit FPM Dichteinsatz. Kabeldurchmesser von 2.0 mm bis 52.0 mm können sicher eingeführt werden.

Dust and exhaust emissions cause high levels of chemical pollution in **tunnels**. This calls for the use of stainless and acid-resistant stainless steel A4 cable glands with FPM sealing insert. Cable diameters from 2.0 mm to 52.0 mm are used here on a daily basis.



Kabelverschraubungen für den Einsatz im **Schiffsbau** müssen spezifische Anforderungen erfüllen. Ein DNV-Zertifikat bescheinigt die Erfüllung dieser Anforderungen. Alle metrischen AGRO Kabelverschraubungen sind DNV zertifiziert. Unabhängig von ihrem Gewinde sind zusätzlich alle AGRO Ex Kabelverschraubungen für den Einsatz im Schiffsbau zugelassen.

For **marine industry**, cable glands have to meet specific requirements. DNV certification grants the fulfillment of such requirements. All metric AGRO cable glands are DNV certified. Additionally all AGRO Ex cable glands are approved, irrespective of their entry thread.

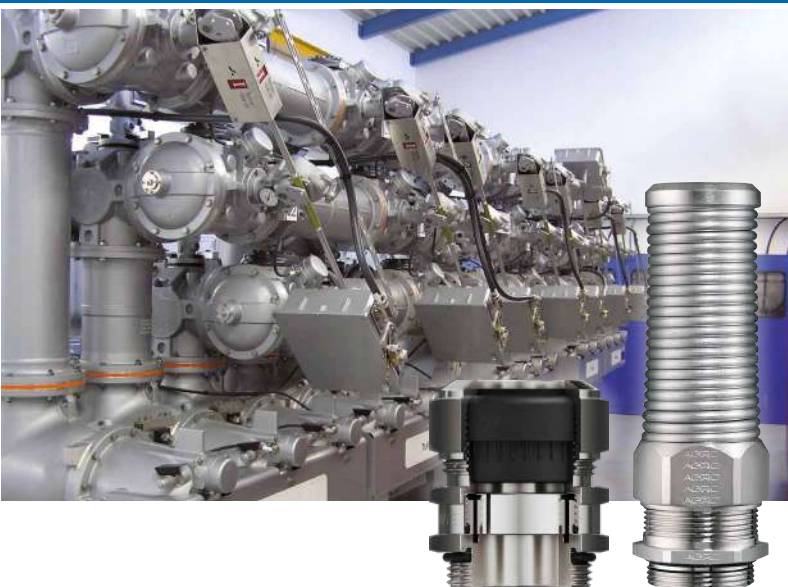

Elektronisch gesteuerte **Umspannstationen** funktionieren so lange reibungslos, wie keine Signale durch Störströme verfälscht werden. Der konzentrische Schirmabgriff der Progress® EMV Kabelverschraubungen führt Störströme auf Masse und garantiert kleinste Transferimpedanzen.

Electronically-controlled **substations** operate in a smooth way as long as parasitic currents do not affect their function. The concentric shielded tap of Progress® EMC cable glands discharges interference currents to earth and thus grants lowest transfer impedance.

In der **Lebensmittelindustrie** kommen Keim abtötende Substanzen zum Einsatz. Diese Substanzen garantieren auf der einen Seite die Hygiene und stellen auf der anderen Seite besondere Anforderungen an die eingesetzten Materialien der Produktionsmittel. Progress® aqua haben die KTW W270 Zulassung und können bedenkenlos in Trinkwasseranlagen eingesetzt werden. Die Kabelverschraubungen der Serie Progress® ultraFLAT sind nach EHEDG zertifiziert.

In **food industries**, anti-bacterial substances guarantee a high level of safety. These chemical agents, however, also place a considerable burden on production facilities. Progress® aqua cable glands are KTW W270 certified for drinking water applications. The cable glands of the Progress® ultraFLAT series are EHEDG certified.



Raffinerien und Produktionsanlagen der chemischen Industrie mit explosionsgefährdeten Bereichen stellen besondere Anforderungen an die elektrische Installation. AGRO bietet zertifizierte Kabelverschraubungen für druckfeste Kapselung Ex d IIC, für erhöhte Sicherheit Ex e II und für Eigensicherheit Ex i II an.

Refineries and production facilities in the chemical industry with potentially explosive areas make specific demands on electrical installations. AGRO offers special cable glands and accessories for "flameproof enclosure Ex d IIC", "increased safety Ex e II" and "intrinsic safety Ex i II" — protection types that have been standardised throughout Europe.

Bei der Realisierung von **Windkraftanlagen** bietet die Progress®-Baureihe eine kabelschonende Zugentlastung mit hoher Verdreh-sicherheit. Dabei spielt es keine Rolle, ob es sich um Rundkabel oder Flachleitungen handelt.

For the implementation of **wind turbine generators**, the Progress® range offers cable protecting strain relief with high distortion protection. This applies to both round and flat cables.



Kabelverschraubungen Progress® in Metall.

Zertifiziert für Schienenfahrzeuge nach EN 45545 und NFPA 130.



AGRO Progress® Kabelverschraubungen aus Metall können mit Dichteinsätzen aus einem speziellem TPE bestückt werden. In dieser Ausführung sind sie zertifiziert nach EN 45545 sowie NFPA 130 und können bedenkenlos für alle Anwendungen und Anordnungen im Schienenfahrzeugbau eingesetzt werden.

Beste Resultate nach EN 45545-2

Die Dichteinsätze der Progress® Kabelverschraubungen sind aus einem speziellen TPE gefertigt und im anspruchsvollsten **Hazard Level 3** zertifiziert. Die geforderten Werte für Hazard Level 3 wurden sowohl im Aussen- als auch im Innenbereich deutlich übertroffen. Auch die Werte für die NFPA (ASTME) waren ausgezeichnet.

EN 45545-2

HL 3



Cable glands Progress® made of metall.

Certified for rolling stock, according to EN 45545 and NFPA 130.

AGRO Progress® metal cable glands can be equipped with sealing inserts made of a special TPE. These versions are certified according to EN 45545 as well as NFPA 130 and can be used with confidence for any rolling stock application.

Best results in testing according to EN 45545-2

The sealing inserts of Progress® cable glands are made from a special TPE and certified to the demanding **Hazard Level 3**. The stipulated values for Hazard Level 3 were exceeded, for both indoor and outdoor areas. The results achieved in NFPA (ASTME) testings were also excellent.



Progress® aqua.

Zertifizierte Kabelverschraubung für Trinkwasseranwendungen.



Gesundheitliche Aspekte haben Gesetzgeber weltweit dazu veranlasst, die Grenzwerte für Inhaltsstoffe im Trinkwasser zu verschärfen. Ein neues Regelwerk des SVGW definiert den Einsatz von Materialien in Kontakt mit Trinkwasser. Armaturen, Wasserverbrauchsapparate, Anlageteile und Installationsmaterialien, welche der Wasserverteilung dienen, sind zertifizierungspflichtig oder müssen als geeignet beurteilt werden. Dabei sind hohe Anforderungen zu erfüllen.

Alle verwendeten Materialien der Progress® aqua haben die **KTW W270** Zulassung und konnten somit vom SVGW zertifiziert werden.

Progress® aqua.

Certified cable glands for drinking water applications.

Due to hygiene reasons, legislatures worldwide have tightened the limits for what substances drinking water may contain. KTW W270, a standard from the Swiss and German gas and water industry associations (SVGW/DVGW), governs the use of materials in contact with drinking water. All fittings, devices, components and installations materials used in the distribution of water must be certified accordingly or confirmed to be suitable.

All materials used in the Progress® aqua series have been certified in accordance with **KTW W270**, and thus comply with national requirements.



Progress® EMV powerCONNECT.

Direkte Anschlusstechnik für hohe Ableitströme auf kleinstem Raum.

Die Progress® EMV powerCONNECT mit der neuartigen fortschrittlichen Presshülse garantiert eine sichere 360° Schirmkontaktierung auf kleinstem Raum. Der direkte Übergang vom Geflecht auf das Unterteil der Kabelverschraubung gewährleistet einen erstaunlich niedrigen Übergangswiderstand.

Progress® EMC powerCONNECT.

Direct connection for high leakage currents.

Progress® EMC powerCONNECT, with its new, advanced compression sleeve, ensures reliable 360° shield contact in a very compact unit. The direct transfer from the shielding to the cable gland's lower part ensures extremely low transfer resistance.

S. 43

Kabelverschraubung 100 mm Gewinde M16 - M32.

Durchführung für Paneelen und Sandwich-Isolationen.

Die langgewindigen Kabelverschraubungen ermöglichen eine elegante Lösung, wenn elektrische Leitungen durch isolierte Gehäuse geführt werden müssen, wie das bei Sandwichkonstruktionen der Fall ist.

Cable gland 100 mm thread M16 - M32.

Can be used to cross panels and sandwich structures.

Long-threaded cable glands provide an elegant solution when electrical cables have to be routed through insulated housings, as is the case with sandwich constructions.



S. 123

Ex Compact.

Mit NPT Gewinde und Klemmbacken.

Mit der Ergänzung der Ex Compact durch Klemmbacken steht eine kompakte druckgekapselt Kabelverschraubung für Anwendungen in Bereich Ex d IIC und erhöhte Sicherheit Ex e II zur Verfügung. Mit den NPT-Gewinden kann auch der nordamerikanische Markt bedient werden.

Ex Compact.

NPT entry thread and clamping jaws.

With the addition of clamping jaws for the Ex Compact cable gland, a compact flameproof enclosure is available for applications in Ex d IIC zones as well as for increased safety Ex e II.

NPT threads can also serve the North American market.



S. 151

Druckausgleichselemente.

Auch für Ex Applikationen.

Der Einbau von AGRO Druckausgleichselementen in Elektro- und Elektronikgehäusen bewirkt einen effizienten Druckausgleich und sorgt für eine konstante Belüftung und bei Bedarf auch für Entwässerung.

Die Messing Druckausgleichselemente sind zertifiziert für Ex Anwendungen.

Pressure balance elements.

Now also for Ex applications.

The use of AGRO pressure balance elements in electrical and electronics housings allows efficient pressure balance and ventilation, and if necessary, drainage.

We also offer versions in nickel-plated brass for Ex applications.



S. 248

AGRO kundenspezifische Lösungen.

Wir machen sie möglich.

Als kompetenter Partner bieten wir nicht nur ein breites Standard-Sortiment sondern entwickeln auch kundenspezifische Lösungen, passend für individuelle Anwendungsfälle.

Schon in der Entwicklungsphase beraten wir Sie bei der Umsetzung Ihrer Projekte. Dadurch ist es möglich, die hohen Anforderungen Ihrer Produkte an Funktionalität und Design unter wirtschaftlichen Gesichtspunkten gemeinsam zu gestalten.

- Viele Lösungen aus unserem Progress® Baukasten sind schnell und einfach realisierbar
- Individuelle Systemlösungen für spezielle Anforderungen
- Umfangreiche Beratung und Bemusterung bereits in der Entwicklungsphase

AGRO customised solutions.

We make it possible.

As your competent partner, we not only offer a wide range of standard products, but also develop customized solutions to accommodate your specific needs.

Already in the development phase, we will be pleased to provide advice on the implementation of your projects. This will enable us to jointly define the high requirements of your products in terms of functionality and design from an economic perspective.

- Many solutions from our Progress® construction set can be implemented quickly and easily
- Individual system solutions for special requirements
- Comprehensive advice and provision of samples as early as the development phase



AGRO Kabelverschraubungen Progress® Messing

AGRO Cable glands Progress® nickel-plated brass

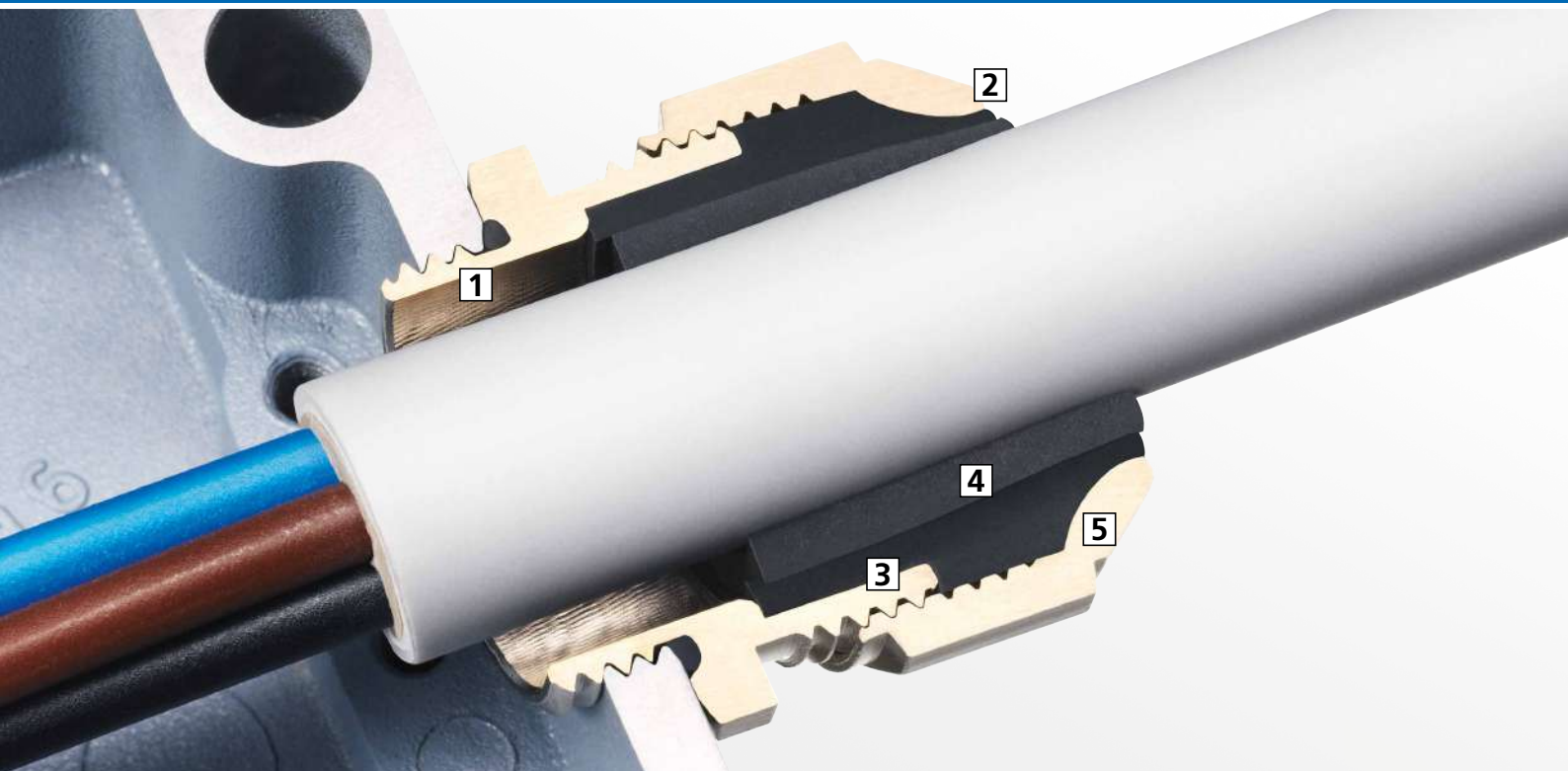

AGRO Kabelverschraubungen Progress® Messing vernickelt sind bewährte Helfer für die fachgerechte Kabeleinführung in Industrieanlagen. Durch die richtige Wahl mit dem passenden Dichteinsatz sind sie überall einsetzbar. Die herausragende Kompressionstechnik sorgt für eine hohe Dichtigkeit und eine äusserst kabelaenschonende Zugentlastung auch bei dynamischen Belastungen.

AGRO Progress® Kabelverschraubungen aus Metall mit Dichteinsätzen aus einem speziellen TPE sind zertifiziert nach EN 45545 sowie NFPA 130 und können bedenkenlos für alle Anwendungen und Anordnungen im Schienenfahrzeugbau eingesetzt werden.

1 Kurze, lange oder Spezial-Anschlussgewinde

Kabelverschraubungen Progress® mit kurzem oder langem Anschlussgewinde in metrischer, Pg-, Gasrohr oder NPT-Ausführung können bei vorhandenem Öffnungsgewinde oder mit Gegenmutter verwendet werden.

2 Sichtbare Sicherheit

Der kleine Wulst des Dichteinsatzes bestätigt das richtige Anzugsdrehmoment.

3 Hoher Verdrehenschutz

Die im Unterteil integrierte Längsrandrierung sorgt über den Dichteinsatz für eine hohe Verdrehsicherheit.

4 Grosse Flexibilität

Zweiteilige Dichteinsätze können in Sekundenschnelle vor Ort auf den vorhandenen Kabeldurchmesser angepasst werden.

5 Garantierte Dichtigkeit

Auf den Dichteinsatz abgestimmte Innenkonturen sorgen für eine zielgerichtete Verformung des Dichteinsatzes und garantieren somit dessen perfekte Abdichtung. Die Schutzart IP 68 bis 10 bar sowie IP 69 ermöglichen eine breite Anwendung.

Cable glands Progress® nickel-plated brass are tried and tested helpers for correct cable entry in industrial equipment. If the correct choice with the right sealing insert, these glands can be used anywhere. The outstanding compression technology for use everywhere guarantees an effective seal and excellent cable-protecting strain relief, also by vibrations.

AGRO Progress® metal cable glands equipped with sealing inserts made of a special TPE are certified according to EN 45545, NFPA 130 and can be used with confidence for any rolling stock application.

1 Short, long or special entry thread

Cable glands Progress® with short or long entry thread designed as metric, Pg, imperial or NPT can be used with existing opening threads or with a counter nut.

2 Visible safety

The small bulge in the sealing insert confirms the correct tightening torque.

3 High distortion protection

The integrated retaining grooves in the lower part and in the sealing insert grant against twisting.

4 Great flexibility

It only takes a few seconds to adapt the two-part sealing inserts on site to the existing cable diameters.

5 Guaranteed seal

Inner contours matched to the sealing insert ensure a targeted deformation of the insert and thus guarantee its tightness in compliance with protection class IP 68 up to 10 bar and IP 69K for a wide range of applications.

Progress®: Der Baukasten | Progress®: Modular part system

Der modulare Aufbau unserer Kernserie Progress® ist eine ihrer ganz grossen Stärken. Die Bauteile sind aufeinander abgestimmt und können frei kombiniert werden.

The modular conception of our core series Progress® is one of its major strengths. The components are matched to each other and can be easily combined.

Standard Oberteile | Standard upper parts

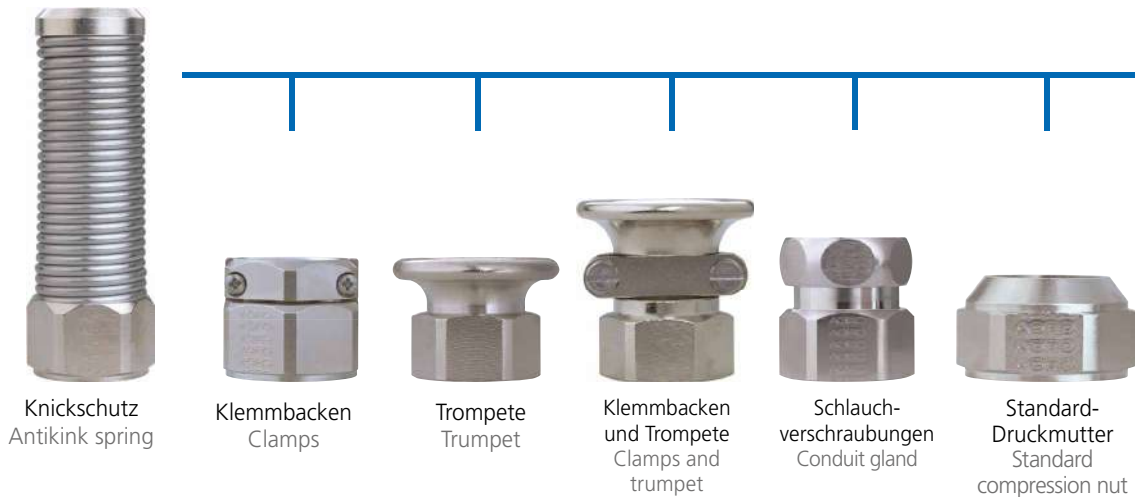

Standard Dichteinsätze | Standard sealing inserts



Kurzer ein- oder zweiteiliger Dichteinsatz in NBR, TPE, Spezial TPE nach EN 45545 oder FPM (temperaturbeständig)

Short one or two-piece sealing insert made of NBR, TPE or special TPE acc. EN 45545 or FPM (heat resistant)

Langer durchgehend isolierender Dichteinsatz in NBR, TPE, Spezial TPE nach EN 45545 ein oder zweiteilig

Long one or two-piece overall length insulating sealing insert made of NBR or TPE special TPE acc. EN 45545

Für die gängigsten Kabeldurchmesser sind Dichteinsätze für die Durchführung mehrerer Kabel verfügbar

For the most common cable diameters, sealing inserts are available for the entry of several cables at once

Standard Unterteile | Standard lower parts



	Progress® Messing Progress® nickel-plated brass	Standard	für hohe Temperaturen for high temperatures	für mehrere Kabel for installation of multiple cables	mit Dichteinsatz with sealing insert without drilled hole	für spezielle Kabel for special cables	mit Knickschutzfeder with antikink spring	mit Klemmbacken with clamps	mit Trompete with trumpet	mit Trompete und Klemmbacken with trumpet and clamps	
Ausführung / Version											
Kompressionstechnik Compression technology		•	•	•	•	•	•	•	•	•	•
Gewinde / Thread											
Anschlussgewinde metrisch Entry thread metric		•	•	•	•	•	•	•	•	•	•
Anschlussgewinde Pg Entry thread Pg		•	•	•	•	•	•	•	•	•	•
Anschlussgewinde NPT Entry thread NPT		•	-	-	-	-	-	-	-	-	-
Anschlussgewinde Gasrohr Entry thread gas pipe		•	-	-	-	-	-	-	-	-	-
Kurzes Anschlussgewinde (Standard) Short entry thread (standard)		•	•	•	•	•	•	•	•	•	•
Langes Anschlussgewinde Long entry thread		•	•	•	•	•	-	•	•	•	•
Sondergewinde (extra lang, Innengewinde) Special thread (extra long, internal thread)		•	-	-	-	-	•	-	-	-	-
Dichteinsatz / Sealing insert											
für Rundkabel for round cables		•	•	•	-	-	•	•	•	•	•
für Flachkabel for flat cables		•	-	-	-	•	-	-	-	-	-
für mehrere Kabel (Multi-Dichteinsatz) for multi sealing insert		•	-	•	-	-	-	-	-	-	-
Vollgummi-Dichteinsatz Solid rubber sealing insert		•	•	-	•	-	-	-	-	-	-
einteiliger Dichteinsatz One-piece sealing insert		•	•	•	•	•	-	•	•	-	-
zweiteiliger Dichteinsatz Two-piece sealing insert		•	•	-	-	-	•	•	•	•	•
Spezial TPE nach EN45545 Special TPE acc. to EN 45545		•	-	•	•	•	•	•	•	•	•
Technische Besonderheiten / Technical features											
Vibrationsschutz Vibration resistance		•	•	•	•	•	•	•	•	•	•
Material / Material											
Messing vernickelt Nickel-plated brass		•	•	•	•	•	•	•	•	•	•



<p>Kabelverschraubungen Progress® Messing Cable glands Progress® nickel-plated brass</p>		<p>16 - 29</p>	<p>1</p>
<p>Kabelverschraubungen Progress® Messing für hohe Temperaturen Cable glands Progress® nickel-plated brass for high temperature applications</p>		<p>30 - 33</p>	<p>2</p>
<p>Kabelverschraubungen Progress® Messing für mehrere Kabel Cable glands Progress® nickel-plated brass for installation of multiple cables</p>		<p>34 - 37</p>	<p>3</p>
<p>Kabelverschraubungen Progress® Messing mit Dichteinsatz ohne Bohrung Cable glands Progress® nickel-plated brass with sealing insert without drilled hole</p>		<p>38 - 39</p>	<p>4</p>
<p>Kabelverschraubungen Progress® Messing für spezielle Kabel Cable glands Progress® nickel-plated brass for special cables</p>		<p>40 - 42</p>	<p>5</p>
<p>Kabelverschraubungen Progress® Messing mit speziellem Anschlussgewinde Cable glands Progress® nickel-plated brass with special entry thread</p>		<p>43 - 44</p>	<p>6</p>
<p>Kabelverschraubungen Progress® Messing mit Knickschutzfeder Cable glands Progress® nickel-plated brass with antikink spring</p>		<p>45 - 47</p>	<p>7</p>
<p>Kabelverschraubungen Progress® Messing mit Klemmbacken Cable glands Progress® nickel-plated brass with clamps</p>		<p>48 - 53</p>	<p>8</p>
<p>Kabelverschraubungen Progress® Messing mit Trompete Cable glands Progress® nickel-plated brass with trumpet</p>		<p>54 - 55</p>	<p>10</p>
<p>Kabelverschraubungen Progress® Messing mit Trompete und Klemmbacken Cable glands Progress® nickel-plated brass with trumpet and clamps</p>		<p>56 - 57</p>	<p>11</p>

Kabelverschraubungen Progress® Messing

Cable glands Progress® nickel-plated brass

Kurzes Anschlussgewinde metrisch | Short entry thread metric

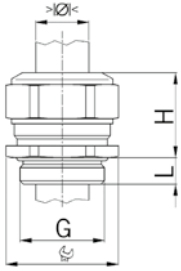

Material: Messing vernickelt
 Dichtung: TPE
 O-Ring: NBR
 Zugentlastung: Ausführung A nach EN 62444
 Einsatztemperatur: -40°C / +100°C
 Schutzart: IP 68 (bis 10 bar)
 Weitere Schutzart: IP 69

Material: Nickel-plated brass
 Seal: TPE
 O-ring: NBR
 Strain relief: Version A acc. to EN 62444
 Temperature range: -40°C / +100°C
 Protection class: IP 68 (up to 10 bar)
 Further protection: IP 69

Progress MS



Einteiliger Dichteinsatz
 durchgehend isolierend

One-piece sealing insert
 overall length insulated

G	>Ø< min mm	>Ø< max mm	Ø mm	H mm	L mm	i info	Art.-Nr. Art. No.	
M6x1.0	2.0	2.5	8	12	5	1	1060.06.025	50
M6x1.0	2.5	3.0	8	12	5	1	1060.06.030	50
M8x1.25	2.5	3.0	11	14	5	1	1060.08.030	50
M8x1.25	3.0	4.0	11	14	5	1	1060.08.040	50
M10x1.5	3.0	4.0	13	15	5	1	1060.10.040	50
M10x1.5	4.0	6.0	13	15	5	1	1060.10.060	50
M12x1.5	3.5	5.0	15	17	5	-	1060.12.050	50
M12x1.5	5.0	6.5	15	17	5	-	1060.12.065	50
M12x1.5	6.5	7.5	15	17	5	-	1060.12.075	50
M16x1.5	4.5	6.0	18	20	5	-	1060.17.060	50
M16x1.5	6.0	8.0	18	20	5	-	1060.17.080	50
M16x1.5	8.0	10.5	18	22	5	-	1060.17.105	50
M20x1.5	6.0	8.0	24	21	6	-	1060.20.080	50
M20x1.5	8.0	11.0	24	21	6	-	1060.20.110	50
M20x1.5	11.0	14.5	24	23	6	-	1060.20.145	50
M25x1.5	9.5	12.5	30	25	7	-	1060.25.125	25
M25x1.5	12.5	16.0	30	25	7	-	1060.25.160	25
M25x1.5	16.0	19.0	30	28	7	-	1060.25.190	25
M32x1.5	17.0	21.0	36	28	8	-	1060.32.210	25
M32x1.5	21.0	25.5	36	28	8	-	1060.32.255	25
M40x1.5	24.0	28.5	46	31	8	-	1060.40.285	10
M40x1.5	28.5	33.0	46	31	8	-	1060.40.330	10
M50x1.5	33.0	37.0	55	34	9	-	1060.50.370	10
M50x1.5	37.0	42.0	55	34	9	-	1060.50.420	10
M63x1.5	40.0	46.0	70	37	10	-	1060.63.460	5
M63x1.5	46.0	52.0	70	37	10	-	1060.63.520	5
M75x1.5	50.0	56.0	80	38	11	-	1060.75.560	1
M75x1.5	56.0	63.0	80	38	11	-	1060.75.630	1

1 = Metrisches Regelgewinde (mit VDE Testreport)

1 = Metric coarse-pitch thread (with VDE test report)

Erhältlich mit Dichteinsatz gemäss EN 45545. Bei Anfragen oder Bestellung bitte ein F vor die Artikelnummer setzen.

Available with sealing inserts conformity with EN 45545. When placing an inquiry, prefix the article number by the capital F.

Progress MS



Zweiteiliger Dichteinsatz
 durchgehend isolierend

Two-piece sealing insert
 overall length insulated

G	>Ø< min mm	>Ø< max mm	>Ø< min mm	>Ø< max mm	Ø mm	H mm	L mm	Art.-Nr. Art. No.	
M16x1.5	6.0	8.0	8.0	10.5	18	22	5	1060.17	50
M20x1.5	8.0	11.0	11.0	14.5	24	23	6	1060.20	50
M25x1.5	12.5	16.0	16.0	19.0	30	28	7	1060.25	25
M32x1.5	17.0	21.0	21.0	25.5	36	28	8	1060.32	25
M40x1.5	24.0	28.5	28.5	33.0	46	31	8	1060.40	10
M50x1.5	33.0	37.0	37.0	42.0	55	34	9	1060.50	10
M63x1.5	41.0	46.0	46.0	52.0	70	37	10	1060.63	5
M75x1.5	50.0	56.0	56.0	63.0	80	38	11	1060.75	1

Erhältlich mit Dichteinsatz gemäss EN 45545. Bei Anfragen oder Bestellung bitte ein F vor die Artikelnummer setzen.

Available with sealing inserts conformity with EN 45545. When placing an inquiry, prefix the article number by the capital F.

Kabelverschraubungen Progress® Messing

Cable glands Progress® nickel-plated brass

Kurzes Anschlussgewinde metrisch | Short entry thread metric

Material: Messing vernickelt
 Dichtung: TPE / NBR
 O-Ring: NBR
 Zugentlastung: Ausführung A nach EN 62444
 Einsatztemperatur: -40°C / +100°C
 Schutzart: IP 68 (bis 10 bar)
 Weitere Schutzart: IP 69

Material: Nickel-plated brass
 Seal: TPE / NBR
 O-ring: NBR
 Strain relief: Version A acc. to EN 62444
 Temperature range: -40°C / +100°C
 Protection class: IP 68 (up to 10 bar)
 Further protection: IP 69

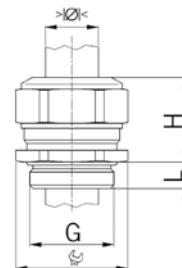

Progress MS



Einteiliger Dichteinsatz
 nicht durchgehend isolierend

One-piece sealing insert
 not overall length insulated

G	>Ø< min mm	>Ø< max mm	 mm	H mm	L mm	i info	Art.-Nr. Art. No.	
M6x1.0	2.0	2.5	8	12	5	1	1000.06.025	50
M6x1.0	2.5	3.0	8	12	5	1	1000.06.030	50
M6x1.0	3.0	3.5	8	12	5	1	1000.06.035	50
M8x1.25	2.5	3.5	11	14	5	1	1000.08.035	50
M8x1.25	3.5	5.0	11	14	5	1	1000.08.050	50
M10x1.5	3.0	4.0	13	15	5	1	1000.10.040	50
M10x1.5	4.0	6.0	13	15	5	1	1000.10.060	50
M12x1.5	3.5	5.0	15	17	5	-	1000.12.050	50
M12x1.5	5.0	6.5	15	17	5	-	1000.12.065	50
M12x1.5	6.5	8.0	15	17	5	-	1000.12.080	50
M16x1.5	3.5	4.5	18	20	5	-	1000.17.045	50
M16x1.5	4.5	6.0	18	20	5	-	1000.17.060	50
M16x1.5	6.0	8.0	18	20	5	-	1000.17.080	50
M16x1.5	8.0	10.5	18	22	5	-	1000.17.105	50
M20x1.5	6.0	8.0	24	21	6	-	1000.20.080	50
M20x1.5	8.0	11.0	24	21	6	-	1000.20.110	50
M20x1.5	11.0	15.0	24	23	6	-	1000.20.150	50
M25x1.5	9.5	12.5	30	25	7	-	1000.25.125	25
M25x1.5	12.5	16.0	30	27	7	-	1000.25.160	25
M25x1.5	16.0	20.5	30	28	7	-	1000.25.205	25
M32x1.5	14.0	17.0	36	28	8	-	1000.32.170	25
M32x1.5	17.0	21.0	36	28	8	-	1000.32.210	25
M32x1.5	21.0	25.5	36	28	8	-	1000.32.255	25
M40x1.5	20.0	24.0	46	31	8	-	1000.40.240	10
M40x1.5	24.0	28.5	46	31	8	-	1000.40.285	10
M40x1.5	28.5	33.0	46	31	8	-	1000.40.330	10
M50x1.5	29.0	33.0	55	34	9	-	1000.50.330	10
M50x1.5	33.0	37.0	55	34	9	-	1000.50.370	10
M50x1.5	37.0	42.0	55	34	9	-	1000.50.420	10
M63x1.5	35.0	40.0	70	37	10	-	1000.63.400	5
M63x1.5	40.0	46.0	70	37	10	-	1000.63.460	5
M63x1.5	46.0	52.0	70	37	10	-	1000.63.520	5
M75x1.5	45.0	50.0	80	38	11	-	1000.75.500	1
M75x1.5	50.0	56.0	80	38	11	-	1000.75.560	1
M75x1.5	56.0	63.0	80	38	11	-	1000.75.630	1
M85x2.0	63.0	70.0	95	41	18	-	1000.85.700	1
M95x2.0	68.0	75.0	110	51	20	-	1000.95.750	1
M95x2.0	73.0	80.0	110	51	20	-	1000.95.800	1
M100x3.0	78.0	85.0	115	51	22	-	1000.100.850	1
M105x3.0	83.0	90.0	120	52	22	-	1000.105.900	1
M115x3.0	88.0	95.0	125	52	22	-	1000.115.950	1



1 = Metrisches Regelgewinde (mit VDE Testreport)

1 = Metric coarse-pitch thread (with VDE test report)

Erhältlich mit Dichteinsatz gemäss EN 45545. Bei Anfragen oder Bestellung bitte ein F vor die Artikelnummer setzen.

Available with sealing inserts conformity with EN 45545. When placing an inquiry, prefix the article number by the capital F.

Kabelverschraubungen Progress® Messing

Cable glands Progress® nickel-plated brass

Kurzes Anschlussgewinde metrisch | Short entry thread metric

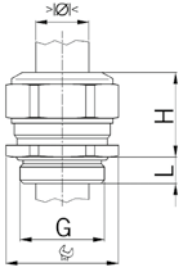

Material: Messing vernickelt
 Dichtung: TPE
 O-Ring: NBR
 Zugentlastung: Ausführung A nach EN 62444
 Einsatztemperatur: -40°C / +100°C
 Schutzart: IP 68 (bis 10 bar)
 Weitere Schutzart: IP 69

Material: Nickel-plated brass
 Seal: TPE
 O-ring: NBR
 Strain relief: Version A acc. to EN 62444
 Temperature range: -40°C / +100°C
 Protection class: IP 68 (up to 10 bar)
 Further protection: IP 69

Progress MS



Zweiteiliger Dichteinsatz
 nicht durchgehend isolierend

Two-piece sealing insert
 not overall length insulated

G	>Ø< min mm	>Ø< max mm	>Ø< min mm	>Ø< max mm	mm	H mm	L mm	Art.-Nr. Art. No.	
M16x1.5	6.0	8.0	8.0	10.5	18	22	5	1000.17	50
M20x1.5	8.00	11.0	11.0	15.0	24	23	6	1000.20	50
M25x1.5	12.5	16.0	16.0	20.5	30	28	7	1000.25	25
M32x1.5	17.0	21.0	21.0	25.5	36	28	8	1000.32	25
M40x1.5	24.0	28.5	28.5	33.0	46	31	8	1000.40	10
M50x1.5	33.0	37.0	37.0	42.0	55	34	9	1000.50	10
M63x1.5	40.0	46.0	46.0	52.0	70	37	10	1000.63	5
M75x1.5	50.0	56.0	56.0	63.0	80	38	11	1000.75	1

Erhältlich mit Dichteinsatz gemäss EN 45545. Bei Anfragen oder Bestellung bitte ein F vor die Artikelnummer setzen.

Available with sealing inserts conformity with EN 45545. When placing an inquiry, prefix the article number by the capital F.

Kabelverschraubungen Progress® Messing

Cable glands Progress® nickel-plated brass

Langes Anschlussgewinde metrisch | Long entry thread metric

Material: Messing vernickelt
 Dichtung: TPE
 O-Ring: NBR
 Zugentlastung: Ausführung A nach EN 62444
 Einsatztemperatur: -40°C / +100°C
 Schutzart: IP 68 (bis 10 bar)
 Weitere Schutzart: IP 69

Material: Nickel-plated brass
 Seal: TPE
 O-ring: NBR
 Strain relief: Version A acc. to EN 62444
 Temperature range: -40°C / +100°C
 Protection class: IP 68 (up to 10 bar)
 Further protection: IP 69

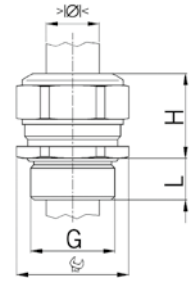

Progress MS



Einteiliger Dichteinsatz
 durchgehend isolierend

One-piece sealing insert
 overall length insulated

G	>Ø< min mm	>Ø< max mm	Ø mm	H mm	L mm	i info	Art.-Nr. Art. No.	
M6x1.0	2.0	2.5	8	12	8	1	1160.06.025	50
M6x1.0	2.5	3.0	8	12	8	1	1160.06.030	50
M8x1.25	2.5	3.0	11	14	10	1	1160.08.030	50
M8x1.25	3.0	4.0	11	14	10	1	1160.08.040	50
M10x1.5	3.0	4.0	13	15	10	1	1160.10.040	50
M10x1.5	4.0	6.0	13	15	10	1	1160.10.060	50
M12x1.5	3.5	5.0	15	17	10	-	1160.12.050	50
M12x1.5	5.0	6.5	15	17	10	-	1160.12.065	50
M12x1.5	6.5	7.5	15	17	10	-	1160.12.075	50
M16x1.5	8.0	10.5	18	22	10	-	1160.17.105	50
M20x1.5	11.0	14.5	24	23	10	-	1160.20.145	50
M25x1.5	16.0	19.0	30	28	11	-	1160.25.190	25
M32x1.5	21.0	25.5	36	28	13	-	1160.32.255	25
M40x1.5	28.5	33.0	46	34	13	-	1160.40.330	10
M50x1.5	37.0	42.0	55	34	14	-	1160.50.420	10
M63x1.5	46.0	52.0	70	37	14	-	1160.63.520	5
M75x1.5	56.0	63.0	80	38	15	-	1160.75.630	1



1 = Metrisches Regelgewinde (mit VDE Testreport)

1 = Metric coarse-pitch thread (with VDE test report)

Erhältlich mit Dichteinsatz gemäss EN 45545. Bei Anfragen oder Bestellung bitte ein F vor die Artikelnummer setzen.

Available with sealing inserts conformity with EN 45545. When placing an inquiry, prefix the article number by the capital F.

Progress MS



Zweiteiliger Dichteinsatz
 durchgehend isolierend

Two-piece sealing insert
 overall length insulated

G	>Ø< min mm	>Ø< max mm	>Ø< min mm	>Ø< max mm	Ø mm	H mm	L mm	Art.-Nr. Art. No.	
M16x1.5	6.0	8.0	8.0	10.5	18	22	10	1160.17	50
M20x1.5	8.0	11.0	11.0	14.5	24	23	10	1160.20	50
M25x1.5	12.5	16.0	16.0	19.0	30	28	11	1160.25	25
M32x1.5	17.0	21.0	21.0	25.5	36	28	13	1160.32	25
M40x1.5	24.0	28.5	28.5	33.0	46	31	13	1160.40	10
M50x1.5	33.0	37.0	37.0	42.0	55	34	14	1160.50	10
M63x1.5	41.0	46.0	46.0	52.0	70	37	14	1160.63	5
M75x1.5	50.0	56.0	56.0	63.0	80	38	15	1160.75	1



Erhältlich mit Dichteinsatz gemäss EN 45545. Bei Anfragen oder Bestellung bitte ein F vor die Artikelnummer setzen.

Available with sealing inserts conformity with EN 45545. When placing an inquiry, prefix the article number by the capital F.

Kabelverschraubungen Progress® Messing

Cable glands Progress® nickel-plated brass

Langes Anschlussgewinde metrisch | Long entry thread metric

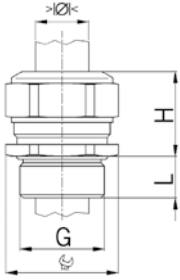

Material:	Messing vernickelt
Dichtung:	TPE
O-Ring:	NBR
Zugentlastung:	Ausführung A nach EN 62444
Einsatztemperatur:	-40°C / +100°C
Schutzart:	IP 68 (bis 10 bar)
Weitere Schutzart:	IP 69

Material:	Nickel-plated brass
Seal:	TPE
O-ring:	NBR
Strain relief:	Version A acc. to EN 62444
Temperature range:	-40°C / +100°C
Protection class:	IP 68 (up to 10 bar)
Further protection:	IP 69



Progress MS



Einteiliger Dichteinsatz
nicht durchgehend isolierend

One-piece sealing insert
not overall length insulated

G	>Ø< min mm	>Ø< max mm	mm	H mm	L mm	i info	Art.-Nr. Art. No.	
M6x1.0	2.0	2.5	8	12	8	1	1100.06.025	50
M6x1.0	2.5	3.0	8	12	8	1	1100.06.030	50
M6x1.0	3.0	3.5	8	12	8	1	1100.06.035	50
M8x1.25	2.5	3.5	11	14	10	1	1100.08.035	50
M8x1.25	3.5	5.0	11	14	10	1	1100.08.050	50
M10x1.5	3.0	4.0	13	15	10	1	1100.10.040	50
M10x1.5	4.0	6.0	13	15	10	1	1100.10.060	50
M12x1.5	3.5	5.0	15	17	10	-	1100.12.050	50
M12x1.5	5.0	6.5	15	17	10	-	1100.12.065	50
M12x1.5	6.5	8.0	15	17	10	-	1100.12.080	50
M16x1.5	3.5	4.5	18	20	10	-	1100.17.045	50
M16x1.5	4.5	6.0	18	20	10	-	1100.17.060	50
M16x1.5	6.0	8.0	18	20	10	-	1100.17.080	50
M16x1.5	8.0	10.5	18	22	10	-	1100.17.105	50
M20x1.5	6.0	8.0	24	21	10	-	1100.20.080	50
M20x1.5	8.0	11.0	24	21	10	-	1100.20.110	50
M20x1.5	11.0	15.0	24	23	10	-	1100.20.150	50
M25x1.5	9.5	12.5	30	25	11	-	1100.25.125	25
M25x1.5	12.5	16.0	30	27	11	-	1100.25.160	25
M25x1.5	16.0	20.5	30	28	11	-	1100.25.205	25
M32x1.5	14.0	17.0	36	28	13	-	1100.32.170	25
M32x1.5	17.0	21.0	36	28	13	-	1100.32.210	25
M32x1.5	21.0	25.5	36	28	13	-	1100.32.255	25
M40x1.5	20.0	24.0	46	31	13	-	1100.40.240	10
M40x1.5	24.0	28.5	46	31	13	-	1100.40.285	10
M40x1.5	28.5	33.0	46	31	13	-	1100.40.330	10
M50x1.5	29.0	33.0	55	34	14	-	1100.50.330	10
M50x1.5	33.0	37.0	55	34	14	-	1100.50.370	10
M50x1.5	37.0	42.0	55	34	14	-	1100.50.420	10
M63x1.5	35.0	40.0	70	37	14	-	1100.63.400	5
M63x1.5	40.0	46.0	70	37	14	-	1100.63.460	5
M63x1.5	46.0	52.0	70	37	14	-	1100.63.520	5
M75x1.5	45.0	50.0	80	38	15	-	1100.75.500	1
M75x1.5	50.0	56.0	80	38	15	-	1100.75.560	1
M75x1.5	56.0	63.0	80	38	15	-	1100.75.630	1

1 = Metrisches Regelgewinde (mit VDE Testreport)

1 = Metric coarse-pitch thread (with VDE test report)

Erhältlich mit Dichteinsatz gemäss EN 45545. Bei Anfragen oder Bestellung bitte ein F vor die Artikelnummer setzen.

Available with sealing inserts conformity with EN 45545. When placing an inquiry, prefix the article number by the capital F.

Langes Anschlussgewinde metrisch | Long entry thread metric

Material: Messing vernickelt
 Dichtung: TPE
 O-Ring: NBR
 Zugentlastung: Ausführung A nach EN 62444
 Einsatztemperatur: -40°C / +100°C
 Schutzart: IP 68 (bis 10 bar)
 Weitere Schutzart: IP 69

Material: Nickel-plated brass
 Seal: TPE
 O-ring: NBR
 Strain relief: Version A acc. to EN 62444
 Temperature range: -40°C / +100°C
 Protection class: IP 68 (up to 10 bar)
 Further protection: IP 69

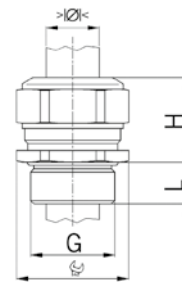

Progress MS



Zweiteiliger Dichteinsatz
 nicht durchgehend isolierend

Two-piece sealing insert
 not overall length insulated

G	>Ø< min mm	>Ø< max mm	>Ø< min mm	>Ø< max mm	mm	H mm	L mm	Art.-Nr. Art. No.	
M16x1.5	6.0	8.0	8.0	10.5	18	22	10	1100.17	50
M20x1.5	8.0	11.0	11.0	15.0	24	23	10	1100.20	50
M25x1.5	12.5	16.0	16.0	20.5	30	28	11	1100.25	25
M32x1.5	17.0	21.0	21.0	25.5	36	28	13	1100.32	25
M40x1.5	24.0	28.5	28.5	33.0	46	31	13	1100.40	10
M50x1.5	33.0	37.0	37.0	42.0	55	34	14	1100.50	10
M63x1.5	40.0	46.0	46.0	52.0	70	37	14	1100.63	5
M75x1.5	50.0	56.0	56.0	63.0	80	38	15	1100.75	1

Erhältlich mit Dichteinsatz gemäss EN 45545. Bei Anfragen oder Bestellung bitte ein F vor die Artikelnummer setzen.

Available with sealing inserts conformity with EN 45545. When placing an inquiry, prefix the article number by the capital F.



Kabelverschraubungen Progress® Messing

Cable glands Progress® nickel-plated brass

Kurzes Anschlussgewinde Pg | Short entry thread Pg

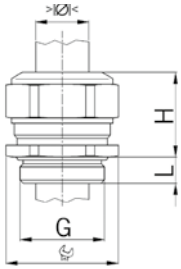

Material: Messing vernickelt
 Dichtung: TPE
 O-Ring: NBR
 Einsatztemperatur: -40°C / +100°C
 Schutzart: IP 68 (bis 10 bar)
 Weitere Schutzart: IP 69

Material: Nickel-plated brass
 Seal: TPE
 O-ring: NBR
 Temperature range: -40°C / +100°C
 Protection class: IP 68 (up to 10 bar)
 Further protection: IP 69



Progress MS

Einteiliger Dichteinsatz durchgehend isolierend

One-piece sealing insert overall length insulated

G	>Ø<		Ø	H	L	Art.-Nr. Art. No.	📦
	min mm	max mm					
Pg 7	3.5	5.0	15	17	6.0	1060.07.050	50
Pg 7	5.0	6.5	15	17	6.0	1060.07.065	50
Pg 7	6.5	7.5	15	17	6.0	1060.07.075	50
Pg 9	4.5	6.0	18	20	6.0	1060.09.060	50
Pg 9	6.0	8.0	18	20	6.0	1060.09.080	50
Pg 9	8.0	10.5	18	22	6.0	1060.09.105	50
Pg 11	4.0	5.5	21	21	6.0	1060.11.055	50
Pg 11	5.5	8.5	21	21	6.0	1060.11.085	50
Pg 11	8.5	12.0	21	21	6.0	1060.11.120	50
Pg 13	6.0	8.0	24	21	6.0	1060.13.080	50
Pg 13	8.0	11.0	24	21	6.0	1060.13.110	50
Pg 13	11.0	14.5	24	23	6.0	1060.13.145	50
Pg 16	6.0	8.0	24	23	6.0	1060.16.080	50
Pg 16	8.0	11.0	24	23	6.0	1060.16.110	50
Pg 16	11.0	14.5	24	23	6.0	1060.16.145	50
Pg 21	9.5	12.5	30	28	7.5	1060.21.125	25
Pg 21	12.5	16.0	30	28	7.5	1060.21.160	25
Pg 21	16.0	19.0	30	28	7.5	1060.21.190	25
Pg 29	19.0	23.0	38	28	8.0	1060.29.230	25
Pg 29	23.0	27.5	38	28	8.0	1060.29.275	25
Pg 36	26.0	30.5	50	32	8.0	1060.36.305	10
Pg 36	30.5	35.0	50	32	8.0	1060.36.350	10
Pg 42	33.0	37.0	55	34	10.0	1060.42.370	10
Pg 42	37.0	42.0	55	34	10.0	1060.42.420	10
Pg 48	37.0	43.0	65	37	11.0	1060.48.430	10
Pg 48	43.0	49.0	65	37	11.0	1060.48.490	10

Erhältlich mit Dichteinsatz gemäss EN 45545. Bei Anfragen oder Bestellung bitte ein F vor die Artikelnummer setzen.

Available with sealing inserts conformity with EN 45545. When placing an inquiry, prefix the article number by the capital F.



Progress MS

Zweiteiliger Dichteinsatz durchgehend isolierend

Two-piece sealing insert overall length insulated

G	>Ø<		>Ø<		Ø	H	L	Art.-Nr. Art. No.	📦
	min mm	max mm	min mm	max mm					
Pg 9	6.0	8.0	8.0	10.5	18	22	6.0	1060.09	50
Pg 11	5.5	8.5	8.5	12.0	21	21	6.0	1060.11	50
Pg 13	8.0	11.0	11.0	14.5	24	23	6.0	1060.13	50
Pg 16	8.0	11.0	11.0	14.5	24	23	6.0	1060.16	50
Pg 21	12.5	16.0	16.0	19.0	30	28	7.5	1060.21	25
Pg 29	19.0	23.0	23.0	27.5	38	28	8.0	1060.29	25
Pg 36	26.0	30.5	30.5	35.0	50	32	8.0	1060.36	10
Pg 42	33.0	37.0	37.0	42.0	55	34	10.0	1060.42	10
Pg 48	37.0	43.0	43.0	49.0	65	37	11.0	1060.48	10

Erhältlich mit Dichteinsatz gemäss EN 45545. Bei Anfragen oder Bestellung bitte ein F vor die Artikelnummer setzen.

Available with sealing inserts conformity with EN 45545. When placing an inquiry, prefix the article number by the capital F.

Kabelverschraubungen Progress® Messing

Cable glands Progress® nickel-plated brass

Kurzes Anschlussgewinde Pg | Short entry thread Pg

Material: Messing vernickelt
 Dichtung: TPE
 O-Ring: NBR
 Einsatztemperatur: -40°C / +100°C
 Schutzart: IP 68 (bis 10 bar)
 Weitere Schutzart: IP 69

Material: Nickel-plated brass
 Seal: TPE
 O-ring: NBR
 Temperature range: -40°C / +100°C
 Protection class: IP 68 (up to 10 bar)
 Further protection: IP 69

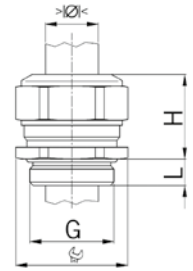

Progress MS



Einteiliger Dichteinsatz
 nicht durchgehend isolierend

One-piece sealing insert
 not overall length insulated

G	>Ø< min mm	>Ø< max mm	Ø mm	H mm	L mm	Art.-Nr. Art. No.	
Pg 7	3.5	5.0	15	17	6.0	1000.07.050	50
Pg 7	5.0	6.5	15	17	6.0	1000.07.065	50
Pg 7	6.5	8.0	15	17	6.0	1000.07.080	50
Pg 9	3.5	4.5	18	20	6.0	1000.09.045	50
Pg 9	4.5	6.0	18	20	6.0	1000.09.060	50
Pg 9	6.0	8.0	18	20	6.0	1000.09.080	50
Pg 9	8.0	10.5	18	22	6.0	1000.09.105	50
Pg 11	4.0	5.5	21	21	6.0	1000.11.055	50
Pg 11	5.5	8.5	21	21	6.0	1000.11.085	50
Pg 11	8.5	12.0	21	21	6.0	1000.11.120	50
Pg 13	6.0	8.0	24	21	6.0	1000.13.080	50
Pg 13	8.0	11.0	24	21	6.0	1000.13.110	50
Pg 13	11.0	15.0	24	23	6.0	1000.13.150	50
Pg 16	6.0	8.0	24	23	6.0	1000.16.080	50
Pg 16	8.0	11.0	24	23	6.0	1000.16.110	50
Pg 16	11.0	15.0	24	23	6.0	1000.16.150	50
Pg 21	9.5	12.5	30	28	7.5	1000.21.125	25
Pg 21	12.5	16.0	30	28	7.5	1000.21.160	25
Pg 21	16.0	20.5	30	28	7.5	1000.21.205	25
Pg 29	16.0	19.0	38	28	8.0	1000.29.190	25
Pg 29	19.0	23.0	38	28	8.0	1000.29.230	25
Pg 29	23.0	27.5	38	28	8.0	1000.29.275	25
Pg 36	21.5	26.0	50	32	8.0	1000.36.260	10
Pg 36	26.0	30.5	50	32	8.0	1000.36.305	10
Pg 36	30.5	35.0	50	32	8.0	1000.36.350	10
Pg 42	29.0	33.0	55	34	10.0	1000.42.330	10
Pg 42	33.0	37.0	55	34	10.0	1000.42.370	10
Pg 42	37.0	42.0	55	34	10.0	1000.42.420	10
Pg 48	32.0	37.0	65	37	11.0	1000.48.370	10
Pg 48	37.0	43.0	65	37	11.0	1000.48.430	10
Pg 48	43.0	49.0	65	37	11.0	1000.48.490	10



Erhältlich mit Dichteinsatz gemäss EN 45545. Bei Anfragen oder Bestellung bitte ein F vor die Artikelnummer setzen.

Available with sealing inserts conformity with EN 45545. When placing an inquiry, prefix the article number by the capital F.

Kabelverschraubungen Progress® Messing

Cable glands Progress® nickel-plated brass

Kurzes Anschlussgewinde Pg | Short entry thread Pg

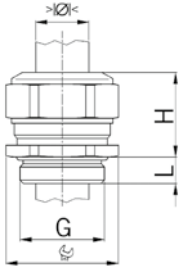

Material: Messing vernickelt
 Dichtung: TPE
 O-Ring: NBR
 Einsatztemperatur: -40°C / +100°C
 Schutzart: IP 68 (bis 10 bar)
 Weitere Schutzart: IP 69

Material: Nickel-plated brass
 Seal: TPE
 O-ring: NBR
 Temperature range: -40°C / +100°C
 Protection class: IP 68 (up to 10 bar)
 Further protection: IP 69



Progress MS



Zweiteiliger Dichteinsatz
 nicht durchgehend isolierend

Two-piece sealing insert
 not overall length insulated

G	>Ø< min mm	>Ø< max mm	>Ø< min mm	>Ø< max mm	Ø mm	H mm	L mm	Art.-Nr. Art. No.	
Pg 9	6.0	8.0	8.0	10.5	18	22	6.0	1000.09	50
Pg 11	5.5	8.5	8.5	12.0	21	21	6.0	1000.11	50
Pg 13	8.0	11.0	11.0	15.0	24	23	6.0	1000.13	50
Pg 16	8.0	11.0	11.0	15.0	24	23	6.0	1000.16	50
Pg 21	12.5	16.0	16.0	20.5	30	28	7.5	1000.21	25
Pg 29	19.0	23.0	23.0	27.5	38	28	8.0	1000.29	25
Pg 36	26.0	30.5	30.5	35.0	50	32	8.0	1000.36	10
Pg 42	33.0	37.0	37.0	42.0	55	34	10.0	1000.42	10
Pg 48	37.0	43.0	43.0	49.0	65	37	11.0	1000.48	10

Erhältlich mit Dichteinsatz gemäss EN 45545. Bei Anfragen oder Bestellung bitte ein F vor die Artikelnummer setzen.

Available with sealing inserts conformity with EN 45545. When placing an inquiry, prefix the article number by the capital F.

Kabelverschraubungen Progress® Messing

Cable glands Progress® nickel-plated brass

Langes Anschlussgewinde Pg | Long entry thread Pg

Material: Messing vernickelt
 Dichtung: TPE
 O-Ring: NBR
 Einsatztemperatur: -40°C / +100°C
 Schutzart: IP 68 (bis 10 bar)
 Weitere Schutzart: IP 69

Material: Nickel-plated brass
 Seal: TPE
 O-ring: NBR
 Temperature range: -40°C / +100°C
 Protection class: IP 68 (up to 10 bar)
 Further protection: IP 69

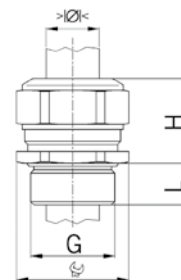

Progress MS



Einteiliger Dichteinsatz
 durchgehend isolierend

One-piece sealing insert
 overall length insulated

G	>Ø< min mm	>Ø< max mm	mm	H mm	L mm	Art.-Nr. Art. No.	
Pg 7	5.0	6.5	15	17	10	1160.07.065	50
Pg 7	6.5	7.5	15	17	10	1160.07.075	50
Pg 9	8.0	10.5	18	22	10	1160.09.105	50
Pg 11	8.5	12.0	21	21	10	1160.11.120	50
Pg 13	11.0	14.5	24	23	10	1160.13.145	50
Pg 16	11.0	14.5	24	23	10	1160.16.145	50
Pg 21	16.0	19.0	30	28	12	1160.21.190	25
Pg 29	23.0	27.5	38	28	12	1160.29.275	25
Pg 36	30.5	35.0	50	32	15	1160.36.350	10
Pg 42	37.0	42.0	55	32	15	1160.42.420	10
Pg 48	43.0	49.0	65	37	15	1160.48.490	10

Erhältlich mit Dichteinsatz gemäss EN 45545. Bei Anfragen oder Bestellung bitte ein F vor die Artikelnummer setzen.

Available with sealing inserts conformity with EN 45545. When placing an inquiry, prefix the article number by the capital F.



Progress MS



Zweiteiliger Dichteinsatz
 durchgehend isolierend

Two-piece sealing insert
 overall length insulated

G	>Ø< min mm	>Ø< max mm	>Ø< min mm	>Ø< max mm	mm	H mm	L mm	Art.-Nr. Art. No.	
Pg 9	6.0	8.0	8.0	10.5	18	22	10	1160.09	50
Pg 11	5.5	8.5	8.5	12.0	21	21	10	1160.11	50
Pg 13	8.0	11.0	11.0	14.5	24	23	10	1160.13	50
Pg 16	8.0	11.0	11.0	14.5	24	23	10	1160.16	50
Pg 21	12.5	16.0	16.0	19.0	30	28	12	1160.21	25
Pg 29	19.0	23.0	23.0	27.5	38	28	12	1160.29	25
Pg 36	26.0	30.5	30.5	35.0	50	32	15	1160.36	10
Pg 42	33.0	37.0	37.0	42.0	55	34	15	1160.42	10
Pg 48	37.0	43.0	43.0	49.0	65	37	15	1160.48	10

Erhältlich mit Dichteinsatz gemäss EN 45545. Bei Anfragen oder Bestellung bitte ein F vor die Artikelnummer setzen.

Available with sealing inserts conformity with EN 45545. When placing an inquiry, prefix the article number by the capital F.



Kabelverschraubungen Progress® Messing

Cable glands Progress® nickel-plated brass

Langes Anschlussgewinde Pg | Long entry thread Pg

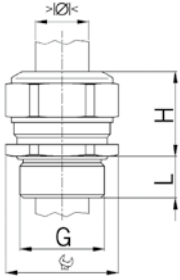

Material: Messing vernickelt
 Dichtung: TPE
 O-Ring: NBR
 Einsatztemperatur: -40°C / +100°C
 Schutzart: IP 68 (bis 10 bar)
 Weitere Schutzart: IP 69

Material: Nickel-plated brass
 Seal: TPE
 O-ring: NBR
 Temperature range: -40°C / +100°C
 Protection class: IP 68 (up to 10 bar)
 Further protection: IP 69



Progress MS



Einteiliger Dichteinsatz
 nicht durchgehend isolierend

One-piece sealing insert
 not overall length insulated

G	>Ø< min mm	>Ø< max mm	Ø mm	H mm	L mm	Art.-Nr. Art. No.	
Pg 7	3.5	5.0	15	17	10	1100.07.050	50
Pg 7	5.0	6.5	15	17	10	1100.07.065	50
Pg 7	6.5	8.0	15	17	10	1100.07.080	50
Pg 9	3.5	4.5	18	20	10	1100.09.045	50
Pg 9	4.5	6.0	18	20	10	1100.09.060	50
Pg 9	6.0	8.0	18	20	10	1100.09.080	50
Pg 9	8.0	10.5	18	22	10	1100.09.105	50
Pg 11	4.0	5.5	21	21	10	1100.11.055	50
Pg 11	5.5	8.5	21	21	10	1100.11.085	50
Pg 11	8.5	12.0	21	21	10	1100.11.120	50
Pg 13	6.0	8.0	24	21	10	1100.13.080	50
Pg 13	8.0	11.0	24	21	10	1100.13.110	50
Pg 13	11.0	15.0	24	23	10	1100.13.150	50
Pg 16	6.0	8.0	24	23	10	1100.16.080	50
Pg 16	8.0	11.0	24	23	10	1100.16.110	50
Pg 16	11.0	15.0	24	23	10	1100.16.150	50
Pg 21	9.5	12.5	30	28	12	1100.21.125	25
Pg 21	12.5	16.0	30	28	12	1100.21.160	25
Pg 21	16.0	20.5	30	28	12	1100.21.205	25
Pg 29	16.0	19.0	38	28	12	1100.29.190	25
Pg 29	19.0	23.0	38	28	12	1100.29.230	25
Pg 29	23.0	27.5	38	28	12	1100.29.275	25
Pg 36	21.5	26.0	50	32	15	1100.36.260	10
Pg 36	26.0	30.5	50	32	15	1100.36.305	10
Pg 36	30.5	35.0	50	32	15	1100.36.350	10
Pg 42	29.0	33.0	55	34	15	1100.42.330	10
Pg 42	33.0	37.0	55	34	15	1100.42.370	10
Pg 42	37.0	42.0	55	34	15	1100.42.420	10
Pg 48	32.0	37.0	65	37	15	1100.48.370	10
Pg 48	37.0	43.0	65	37	15	1100.48.430	10
Pg 48	43.0	49.0	65	37	15	1100.48.490	10

Erhältlich mit Dichteinsatz gemäss EN 45545. Bei Anfragen oder Bestellung bitte ein F vor die Artikelnummer setzen.

Available with sealing inserts conformity with EN 45545. When placing an inquiry, prefix the article number by the capital F.

Kabelverschraubungen Progress® Messing

Cable glands Progress® nickel-plated brass

Langes Anschlussgewinde Pg | Long entry thread Pg

Material: Messing vernickelt
 Dichtung: TPE
 O-Ring: NBR
 Einsatztemperatur: -40°C / +100°C
 Schutzart: IP 68 (bis 10 bar)
 Weitere Schutzart: IP 69

Material: Nickel-plated brass
 Seal: TPE
 O-ring: NBR
 Temperature range: -40°C / +100°C
 Protection class: IP 68 (up to 10 bar)
 Further protection: IP 69

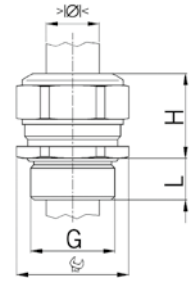

Progress MS



Zweiteiliger Dichteinsatz
 nicht durchgehend isolierend

Two-piece sealing insert
 not overall length insulated

G	>Ø< min mm	>Ø< max mm	>Ø< min mm	>Ø< max mm	Ø mm	H mm	L mm	Art.-Nr. Art. No.	
Pg 9	6.0	8.0	8.0	10.5	18	22	10	1100.09	50
Pg 11	5.5	8.5	8.5	12.0	21	21	10	1100.11	50
Pg 13	8.0	11.0	11.0	15.0	24	23	10	1100.13	50
Pg 16	8.0	11.0	11.0	15.0	24	23	10	1100.16	50
Pg 21	12.5	16.0	16.0	20.5	30	28	12	1100.21	25
Pg 29	19.0	23.0	23.0	27.5	38	28	12	1100.29	25
Pg 36	26.0	30.5	30.5	35.0	50	32	15	1100.36	10
Pg 42	33.0	37.0	37.0	42.0	55	34	15	1100.42	10
Pg 48	37.0	43.0	43.0	49.0	65	37	15	1100.48	10

Erhältlich mit Dichteinsatz gemäss EN 45545. Bei Anfragen oder Bestellung bitte ein F vor die Artikelnummer setzen.

Available with sealing inserts conformity with EN 45545. When placing an inquiry, prefix the article number by the capital F.



Kabelverschraubungen Progress® Messing

Cable glands Progress® nickel-plated brass

Anschlussgewinde NPT | Entry thread NPT

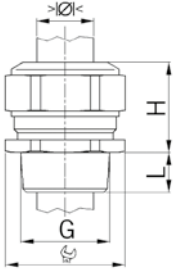

Material: Messing vernickelt
 Dichtung: TPE
 Einsatztemperatur: -40°C / +100°C
 Schutzart: IP 68 (bis 10 bar)
 Weitere Schutzart: IP 69
 Gewinde: IP 68, wenn Anschlussgewinde abgedichtet

Material: Nickel-plated brass
 Seal: TPE
 Temperature range: -40°C / +100°C
 Protection class: IP 68 (up to 10 bar)
 Further protection: IP 69
 Entry thread: IP 68, if the entry thread is sealed



Progress NPT

Einteiliger Dichteinsatz
 nicht durchgehend isolierend

One-piece sealing insert
 not overall length insulated

G	> Ø < min mm	> Ø < max mm	Ø mm	H mm	L mm	Art.-Nr. Art. No.	
NPT 1/8"	3.0	4.0	13	15	8	1000.1/8NPT.040	50
NPT 1/8"	4.0	6.0	13	15	8	1000.1/8NPT.060	50
NPT 1/4"	3.5	5.0	15	17	12	1000.1/4NPT.050	50
NPT 1/4"	5.0	6.5	15	17	12	1000.1/4NPT.065	50
NPT 1/4"	6.5	8.0	15	17	12	1000.1/4NPT.080	50
NPT 3/8"	3.5	4.5	18	20	12	1000.3/8NPT.045	50
NPT 3/8"	4.5	6.0	18	20	12	1000.3/8NPT.060	50
NPT 3/8"	6.0	8.0	18	20	12	1000.3/8NPT.080	50
NPT 3/8"	8.0	10.5	18	22	12	1000.3/8NPT.105	50
NPT 1/2"	6.0	8.0	24	21	15	1000.1/2NPT.080	50
NPT 1/2"	8.0	11.0	24	21	15	1000.1/2NPT.110	50
NPT 1/2"	11.0	15.0	24	23	15	1000.1/2NPT.150	50
NPT 3/4"	9.5	12.5	30	28	15	1000.3/4NPT.125	25
NPT 3/4"	12.5	16.0	30	28	15	1000.3/4NPT.160	25
NPT 3/4"	16.0	20.5	30	28	15	1000.3/4NPT.205	25
NPT 1"	14.0	17.0	36	28	20	1000.1NPT.170	25
NPT 1"	17.0	21.0	36	28	20	1000.1NPT.210	25
NPT 1"	21.0	25.5	36	28	20	1000.1NPT.255	25
NPT 1 1/4"	20.0	24.0	46	31	20	1000.11/4NPT.240	10
NPT 1 1/4"	24.0	28.5	46	31	20	1000.11/4NPT.285	10
NPT 1 1/4"	28.5	33.0	46	31	20	1000.11/4NPT.330	10
NPT 1 1/2"	29.0	33.0	55	34	22	1000.11/2NPT.330	10
NPT 1 1/2"	33.0	37.0	55	34	22	1000.11/2NPT.370	10
NPT 1 1/2"	37.0	41.0	55	34	22	1000.11/2NPT.410	10
NPT 2"	35.0	40.0	70	37	22	1000.2NPT.400	5
NPT 2"	40.0	46.0	70	37	22	1000.2NPT.460	5
NPT 2"	46.0	52.0	70	37	22	1000.2NPT.520	5



Progress NPT

Zweiteiliger Dichteinsatz
 nicht durchgehend isolierend

Two-piece sealing insert
 not overall length insulated

G	> Ø < min mm	> Ø < max mm	> Ø < min mm	> Ø < max mm	Ø mm	H mm	L mm	Art.-Nr. Art. No.	
NPT 3/8"	6.0	8.0	8.0	10.5	18	22	12	1000.3/8NPT	50
NPT 1/2"	8.0	11.0	11.0	15.0	24	23	15	1000.1/2NPT	50
NPT 3/4"	12.5	16.0	16.0	20.5	30	28	15	1000.3/4NPT	25
NPT 1"	17.0	21.0	21.0	25.5	36	28	20	1000.1NPT	25
NPT 1 1/4"	24.0	28.5	28.5	33.0	46	31	20	1000.11/4NPT	10
NPT 1 1/2"	33.0	37.0	37.0	41.0	55	34	22	1000.11/2NPT	10
NPT 2"	40.0	46.0	46.0	52.0	70	37	22	1000.2NPT	5



Kabelverschraubungen Progress® Messing

Cable glands Progress® nickel-plated brass

Anschlussgewinde Gasrohr | Gas-pipe entry thread

Material: Messing vernickelt
 Dichtung: TPE
 O-Ring: NBR
 Einsatztemperatur: -40°C / +100°C
 Schutzart: IP 68

Material: Nickel-plated brass
 Seal: TPE
 O-ring: NBR
 Temperature range: -40°C / +100°C
 Protection class: IP 68

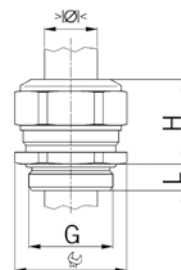

G					 mm	H mm	L mm	i info	Art.-Nr. Art. No.	
	min mm	max mm	min mm	max mm						
G 3/8"	5.5	8.5	8.5	12.0	21	21	6	-	1000.3/8G	50
G 1/2"	8.0	11.0	11.0	15.0	24	23	8	-	1000.1/2G	50
G 3/4"	12.5	16.0	16.0	20.5	30	28	10	-	1000.3/4G	25
G 1"	17.0	21.0	21.0	25.5	36	28	11	-	1000.1G	25
G 1 1/2"	25.0	30.5	30.5	35.0	55/50	32	12	-	1000.11/2G	10
G 2"	37.0	43.0	43.0	49.0	65	37	12	-	1000.2G	10
G 2 1/2"	-	-	45.0	50.0	80	38	18	1	1000.21/2G.500	1
G 2 1/2"	-	-	50.0	56.0	80	38	18	1	1000.21/2G.560	1
G 3"	-	-	56.0	63.0	80	38	18	1	1000.3G.630	1
G 3"	-	-	63.0	70.0	95	40	18	1	1000.3G.700	1

1 = Einteiliger Dichteinsatz

1 = One-piece sealing insert

Kabelverschraubungen Progress® Messing für hohe Temperaturen

Cable glands Progress® nickel-plated brass for high temperature applications

Kurzes Anschlussgewinde metrisch | Short entry thread metric

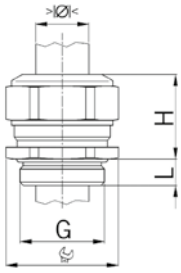

Material: Messing vernickelt
 Dichtung: FPM
 O-Ring: FPM
 Zugentlastung: Ausführung A nach EN 62444
 Einsatztemperatur: -40°C / +200°C
 Schutzart: IP 68 (bis 10 bar)
 Weitere Schutzart: IP 69

Material: Nickel-plated brass
 Seal: FPM
 O-ring: FPM
 Strain relief: Version A acc. to EN 62444
 Temperature range: -40°C / +200°C
 Protection class: IP 68 (up to 10 bar)
 Further protection: IP 69



Progress MS HT



Einteiliger Dichteinsatz
 nicht durchgehend isolierend

One-piece sealing insert
 not overall length insulated

G	> Ø < min mm	> Ø < max mm	mm	H mm	L mm	i info	Art.-Nr. Art. No.	
M6x1.0	2.0	2.5	8	12	5	1	1000.06.91.025	50
M6x1.0	2.5	3.0	8	12	5	1	1000.06.91.030	50
M6x1.0	3.0	3.5	8	12	5	1	1000.06.91.035	50
M8x1.25	2.5	3.5	11	14	5	1	1000.08.91.035	50
M8x1.25	3.5	5.0	11	14	5	1	1000.08.91.050	50
M10x1.5	3.0	4.0	13	15	5	1	1000.10.91.040	50
M10x1.5	4.0	6.0	13	15	5	1	1000.10.91.060	50
M12x1.5	3.5	5.0	15	17	5	-	1000.12.91.050	50
M12x1.5	5.0	6.5	15	17	5	-	1000.12.91.065	50
M12x1.5	6.5	8.0	15	17	5	-	1000.12.91.080	50
M16x1.5	8.0	10.5	18	22	5	-	1000.17.91.105	50
M20x1.5	11.0	15.0	24	23	6	-	1000.20.91.150	50
M25x1.5	16.0	20.5	30	28	7	-	1000.25.91.205	25
M32x1.5	21.0	25.5	36	28	8	-	1000.32.91.255	25
M40x1.5	28.5	33.0	46	31	8	-	1000.40.91.330	10
M50x1.5	37.0	42.0	55	34	9	-	1000.50.91.420	10
M63x1.5	46.0	52.0	70	37	10	-	1000.63.91.520	5

1 = Metrisches Regelgewinde (mit VDE Testreport)

1 = Metric coarse-pitch thread (with VDE test report)



Progress MS HT



Zweiteiliger Dichteinsatz
 nicht durchgehend isolierend

Two-piece sealing insert
 not overall length insulated

G	> Ø < min mm	> Ø < max mm	> Ø < min mm	> Ø < max mm	mm	H mm	L mm	Art.-Nr. Art. No.	
M16x1.5	6.0	8.0	8.0	10.5	18	22	5	1000.17.92	50
M20x1.5	8.0	11.0	11.0	15.0	24	23	6	1000.20.92	50
M25x1.5	12.5	16.0	16.0	20.5	30	28	7	1000.25.92	25
M32x1.5	17.0	21.0	21.0	25.5	36	28	8	1000.32.92	25
M40x1.5	24.0	28.5	28.5	33.0	46	31	8	1000.40.92	10
M50x1.5	33.0	37.0	37.0	42.0	55	34	9	1000.50.92	10
M63x1.5	40.0	46.0	46.0	52.0	70	37	10	1000.63.92	5

Kabelverschraubungen Progress® Messing für hohe Temperaturen

Cable glands Progress® nickel-plated brass for high temperature applications

Langes Anschlussgewinde metrisch | Long entry thread metric

Material: Messing vernickelt
 Dichtung: FPM
 O-Ring: FPM
 Zugentlastung: Ausführung A nach EN 62444
 Einsatztemperatur: -40°C / +200°C
 Schutzart: IP 68 (bis 10 bar)
 Weitere Schutzart: IP 69

Material: Nickel-plated brass
 Seal: FPM
 O-ring: FPM
 Strain relief: Version A acc. to EN 62444
 Temperature range: -40°C / +200°C
 Protection class: IP 68 (up to 10 bar)
 Further protection: IP 69

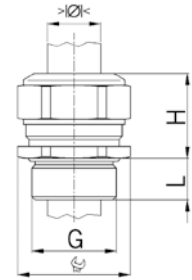

Progress MS HT

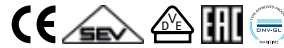

Einteiliger Dichteinsatz
 nicht durchgehend isolierend

One-piece sealing insert
 not overall length insulated

G	>Ø< min mm	>Ø< max mm	mm	H mm	L mm	i info	Art.-Nr. Art. No.	
M6x1.0	2.0	2.5	8	12	8	1	1100.06.91.025	50
M6x1.0	2.5	3.0	8	12	8	1	1100.06.91.030	50
M6x1.0	3.0	3.5	8	12	8	1	1100.06.91.035	50
M8x1.25	2.5	3.5	11	14	10	1	1100.08.91.035	50
M8x1.25	3.5	5.0	11	14	10	1	1100.08.91.050	50
M10x1.5	3.0	4.0	13	15	10	1	1100.10.91.040	50
M10x1.5	4.0	6.0	13	15	10	1	1100.10.91.060	50
M12x1.5	3.5	5.0	15	17	10	-	1100.12.91.050	50
M12x1.5	5.0	6.5	15	17	10	-	1100.12.91.065	50
M12x1.5	6.5	8.0	15	17	10	-	1100.12.91.080	50
M16x1.5	8.0	10.5	18	22	10	-	1100.17.91.105	50
M20x1.5	11.0	15.0	24	23	10	-	1100.20.91.150	50
M25x1.5	16.0	20.5	30	28	11	-	1100.25.91.205	25
M32x1.5	21.0	25.5	36	28	13	-	1100.32.91.255	25
M40x1.5	28.5	33.0	46	31	13	-	1100.40.91.330	10
M50x1.5	37.0	42.0	55	34	14	-	1100.50.91.420	10
M63x1.5	46.0	52.0	70	37	14	-	1100.63.91.520	5

1 = Metrisches Regelgewinde (mit VDE Testreport)

1 = Metric coarse-pitch thread (with VDE test report)



Progress MS HT



Zweiteiliger Dichteinsatz
 nicht durchgehend isolierend

Two-piece sealing insert
 not overall length insulated

G	>Ø< min mm	>Ø< max mm	>Ø< min mm	>Ø< max mm	mm	H mm	L mm	Art.-Nr. Art. No.	
M16x1.5	6.0	8.0	8.0	10.5	18	22	10	1100.17.92	50
M20x1.5	8.0	11.0	11.0	15.0	24	23	10	1100.20.92	50
M25x1.5	12.5	16.0	16.0	20.5	30	28	11	1100.25.92	25
M32x1.5	17.0	21.0	21.0	25.5	36	28	13	1100.32.92	25
M40x1.5	24.0	28.5	28.5	33.0	46	31	13	1100.40.92	10
M50x1.5	33.0	37.0	37.0	42.0	55	34	14	1100.50.92	10
M63x1.5	40.0	46.0	46.0	52.0	70	37	14	1100.63.92	5



Kabelverschraubungen Progress® Messing für hohe Temperaturen

Cable glands Progress® nickel-plated brass for high temperature applications

Kurzes Anschlussgewinde Pg | Short entry thread Pg

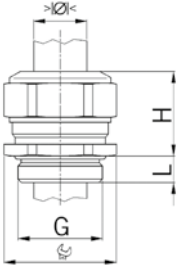

Material: Messing vernickelt
 Dichtung: FPM
 O-Ring: FPM
 Einsatztemperatur: -40°C / +200°C
 Schutzart: IP 68 (bis 10 bar)
 Weitere Schutzart: IP 69

Material: Nickel-plated brass
 Seal: FPM
 O-ring: FPM
 Temperature range: -40°C / +200°C
 Protection class: IP 68 (up to 10 bar)
 Further protection: IP 69



Progress MS HT



Einteiliger Dichteinsatz
 nicht durchgehend isolierend

One-piece sealing insert
 not overall length insulated

G	>Ø< min mm	>Ø< max mm	Ø mm	H mm	L mm	Art.-Nr. Art. No.	
Pg 7	3.5	5.0	15	17	6	1000.07.91.050	50
Pg 7	5.0	6.5	15	17	6	1000.07.91.065	50
Pg 7	6.5	8.0	15	17	6	1000.07.91.080	50
Pg 9	8.0	10.5	18	22	6	1000.09.91.105	50
Pg 11	8.5	12.0	21	21	6	1000.11.91.120	50
Pg 13	11.0	15.0	24	23	6	1000.13.91.150	50
Pg 16	11.0	15.0	24	23	6	1000.16.91.150	50
Pg 21	16.0	20.5	30	28	7	1000.21.91.205	25
Pg 29	23.0	27.5	38	28	8	1000.29.91.275	25
Pg 36	30.5	35.0	50	32	8	1000.36.91.350	10
Pg 42	37.0	42.0	55	34	10	1000.42.91.420	10
Pg 48	43.0	49.0	65	37	11	1000.48.91.490	10



Progress MS HT



Zweiteiliger Dichteinsatz
 nicht durchgehend isolierend

Two-piece sealing insert
 not overall length insulated

G	>Ø< min mm	>Ø< max mm	>Ø< min mm	>Ø< max mm	Ø mm	H mm	L mm	Art.-Nr. Art. No.	
Pg 9	6.0	8.0	8.0	10.5	18	22	6	1000.09.92	50
Pg 11	5.5	8.5	8.5	12.0	21	21	6	1000.11.92	50
Pg 13	8.0	11.0	11.0	15.0	24	23	6	1000.13.92	50
Pg 16	8.0	11.0	11.0	15.0	24	23	6	1000.16.92	50
Pg 21	12.5	16.0	16.0	20.5	30	28	7	1000.21.92	25
Pg 29	19.0	23.0	23.0	27.5	38	28	8	1000.29.92	25
Pg 36	26.0	30.5	30.5	35.0	50	32	8	1000.36.92	10
Pg 42	33.0	37.0	37.0	42.0	55	34	10	1000.42.92	10
Pg 48	37.0	43.0	43.0	49.0	65	37	11	1000.48.92	10

Kabelverschraubungen Progress® Messing für hohe Temperaturen

Cable glands Progress® nickel-plated brass for high temperature applications

Langes Anschlussgewinde Pg | Long entry thread Pg

Material: Messing vernickelt
 Dichtung: FPM
 O-Ring: FPM
 Einsatztemperatur: -40°C / +200°C
 Schutzart: IP 68 (bis 10 bar)
 Weitere Schutzart: IP 69

Material: Nickel-plated brass
 Seal: FPM
 O-ring: FPM
 Temperature range: -40°C / +200°C
 Protection class: IP 68 (up to 10 bar)
 Further protection: IP 69

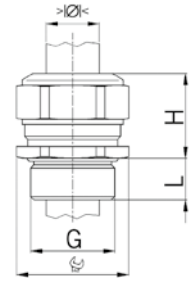

Progress MS HT



Einteiliger Dichteinsatz
 nicht durchgehend isolierend

One-piece sealing insert
 not overall length insulated

G	>Ø< min mm	>Ø< max mm	Ø mm	H mm	L mm	Art.-Nr. Art. No.	
Pg 7	3.5	5.0	15	17	10	1100.07.91.050	50
Pg 7	5.0	6.5	15	17	10	1100.07.91.065	50
Pg 7	6.5	8.0	15	17	10	1100.07.91.080	50
Pg 9	8.0	10.5	18	22	10	1100.09.91.105	50
Pg 11	8.5	12.0	21	21	10	1100.11.91.120	50
Pg 13	11.0	15.0	24	23	10	1100.13.91.150	50
Pg 16	11.0	15.0	24	23	10	1100.16.91.150	50
Pg 21	16.0	20.5	30	28	12	1100.21.91.205	25
Pg 29	23.0	27.5	38	28	12	1100.29.91.275	25
Pg 36	30.5	35.0	50	32	15	1100.36.91.350	10
Pg 42	37.0	42.0	55	34	15	1100.42.91.420	10
Pg 48	43.0	49.0	65	37	15	1100.48.91.490	10



Progress MS HT



Zweiteiliger Dichteinsatz
 nicht durchgehend isolierend

Two-piece sealing insert
 not overall length insulated

G	>Ø< min mm	>Ø< max mm	>Ø< min mm	>Ø< max mm	Ø mm	H mm	L mm	Art.-Nr. Art. No.	
Pg 9	6.0	8.0	8.0	10.5	18	22	10	1100.09.92	50
Pg 11	5.5	8.5	8.5	12.0	21	21	10	1100.11.92	50
Pg 13	8.0	11.0	11.0	15.0	24	23	10	1100.13.92	50
Pg 16	8.0	11.0	11.0	15.0	24	23	10	1100.16.92	50
Pg 21	12.5	16.0	16.0	20.5	30	28	12	1100.21.92	25
Pg 29	19.0	23.0	23.0	27.5	38	28	12	1100.29.92	25
Pg 36	26.0	30.5	30.5	35.0	50	32	15	1100.36.92	10
Pg 42	33.0	37.0	37.0	42.0	55	34	15	1100.42.92	10
Pg 48	37.0	43.0	43.0	49.0	65	37	15	1100.48.92	10



Kabelverschraubungen Progress® Messing für mehrere Kabel

Cable glands Progress® nickel-plated brass for installation of multiple cables

Kurzes Anschlussgewinde metrisch | Short entry thread metric

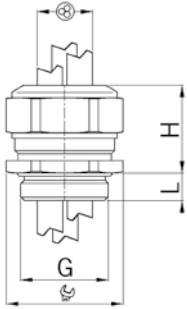

Material: Messing vernickelt
 Dichtung: TPE
 O-Ring: NBR
 Zugentlastung: Ausführung A nach EN 62444
 Einsatztemperatur: -40°C / +100°C
 Schutzart: IP 68

Material: Nickel-plated brass
 Seal: TPE
 O-ring: NBR
 Strain relief: Version A acc. to EN 62444
 Temperature range: -40°C / +100°C
 Protection class: IP 68



Progress MS Multi



Einteiliger Dichteinsatz
 nicht durchgehend isolierend

One-piece sealing insert
 not overall length insulated

G	> Ø <	> Ø <	⊗	⊗	H	L	Art.-Nr. Art. No.	☐
	min mm	max mm		mm	mm	mm		
M16x1.5	2.0	3.0	2	18	22	5	1310.17.2.030	50
M16x1.5	2.5	4.0	2	18	22	5	1310.17.2.040	50
M16x1.5	3.5	5.0	2	18	22	5	1310.17.2.050	50
M20x1.5	3.5	5.0	2	24	23	6	1310.20.2.050	50
M20x1.5	4.5	6.0	2	24	23	6	1310.20.2.060	50
M20x1.5	5.5	7.5	2	24	23	6	1310.20.2.075	50
M20x1.5	3.5	5.0	3	24	23	6	1310.20.3.050	50
M20x1.5	4.5	6.0	3	24	23	6	1310.20.3.060	50
M20x1.5	5.2	6.5	3	24	23	6	1310.20.3.065	50
M20x1.5	3.5	5.0	4	24	23	6	1310.20.4.050	50
M20x1.5	4.5	6.0	4	24	23	6	1310.20.4.060	50
M25x1.5	5.0	7.0	2	30	28	7	1310.25.2.070	25
M25x1.5	6.7	9.0	2	30	28	7	1310.25.2.090	25
M25x1.5	7.7	10.0	2	30	28	7	1310.25.2.100	25
M25x1.5	5.5	7.0	3	30	28	7	1310.25.3.070	25
M25x1.5	6.8	9.0	3	30	28	7	1310.25.3.090	25
M25x1.5	5.5	7.0	4	30	28	7	1310.25.4.070	25
M25x1.5	4.8	6.0	6	30	28	7	1310.25.6.060	25
M32x1.5	9.0	11.5	2	36	28	8	1310.32.2.115	25
M32x1.5	7.0	9.0	3	36	28	8	1310.32.3.090	25
M32x1.5	8.5	10.5	3	36	28	8	1310.32.3.105	25
M32x1.5	7.0	9.0	4	36	28	8	1310.32.4.090	25
M32x1.5	5.8	7.0	6	36	28	8	1310.32.6.070	25

Weitere Ausführungen und Anschlussgewinde auf Anfrage

Further versions and entry threads are available upon request.

Erhältlich mit Dichteinsatz gemäss EN 45545. Bei Anfragen oder Bestellung bitte ein F vor die Artikelnummer setzen.

Available with sealing inserts conformity with EN 45545. When placing an inquiry, prefix the article number by the capital F.

Kabelverschraubungen Progress® Messing für mehrere Kabel Cable glands Progress® nickel-plated brass for installation of multiple cables

Langes Anschlussgewinde metrisch | Long entry thread metric

Material: Messing vernickelt
Dichtung: TPE
O-Ring: NBR
Zugentlastung: Ausführung A nach EN 62444
Einsatztemperatur: -40°C / +100°C
Schutzart: IP 68

Material: Nickel-plated brass
Seal: TPE
O-ring: NBR
Strain relief: Version A acc. to EN 62444
Temperature range: -40°C / +100°C
Protection class: IP 68

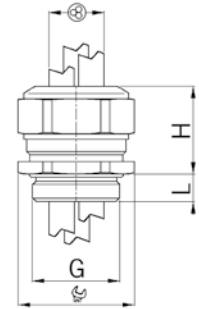

Progress MS Multi



Einteiliger Dichteinsatz
nicht durchgehend isolierend

One-piece sealing insert
not overall length insulated

G	>Ø< min mm	>Ø< max mm	⊗	⊗ mm	H mm	L mm	Art.-Nr. Art. No.	
M16x1.5	2.0	3.0	2	18	22	10	1311.17.2.030	50
M16x1.5	2.5	4.0	2	18	22	10	1311.17.2.040	50
M16x1.5	3.5	5.0	2	18	22	10	1311.17.2.050	50
M20x1.5	3.5	5.0	2	24	23	10	1311.20.2.050	50
M20x1.5	4.5	6.0	2	24	23	10	1311.20.2.060	50
M20x1.5	5.5	7.5	2	24	23	10	1311.20.2.075	50
M20x1.5	3.5	5.0	3	24	23	10	1311.20.3.050	50
M20x1.5	4.5	6.0	3	24	23	10	1311.20.3.060	50
M20x1.5	5.2	6.5	3	24	23	10	1311.20.3.065	50
M20x1.5	3.5	5.0	4	24	23	10	1311.20.4.050	50
M20x1.5	4.5	6.0	4	24	23	10	1311.20.4.060	50
M25x1.5	5.0	7.0	2	30	28	11	1311.25.2.070	25
M25x1.5	6.7	9.0	2	30	28	11	1311.25.2.090	25
M25x1.5	7.7	10.0	2	30	28	11	1311.25.2.100	25
M25x1.5	5.5	7.0	3	30	28	11	1311.25.3.070	25
M25x1.5	6.8	9.0	3	30	28	11	1311.25.3.090	25
M25x1.5	5.5	7.0	4	30	28	11	1311.25.4.070	25
M25x1.5	4.8	6.0	6	30	28	11	1311.25.6.060	25
M32x1.5	9.0	11.5	2	36	28	13	1311.32.2.115	25
M32x1.5	7.0	9.0	3	36	28	13	1311.32.3.090	25
M32x1.5	8.5	10.5	3	36	28	13	1311.32.3.105	25
M32x1.5	7.0	9.0	4	36	28	13	1311.32.4.090	25
M32x1.5	5.8	7.0	6	36	28	13	1311.32.6.070	25



Weitere Ausführungen und Anschlussgewinde auf Anfrage

Further versions and entry threads are available upon request.

Erhältlich mit Dichteinsatz gemäss EN 45545. Bei Anfragen oder Bestellung bitte ein F vor die Artikelnummer setzen.

Available with sealing inserts conformity with EN 45545. When placing an inquiry, prefix the article number by the capital F.

Kabelverschraubungen Progress® Messing für mehrere Kabel

Cable glands Progress® nickel-plated brass for installation of multiple cables

Kurzes Anschlussgewinde Pg | Short entry thread Pg

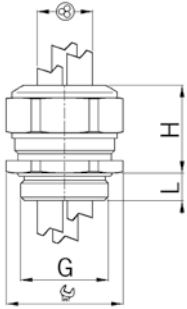

Material: Messing vernickelt
 Dichtung: TPE
 O-Ring: NBR
 Einsatztemperatur: -40°C / +100°C
 Schutzart: IP 68

Material: Nickel-plated brass
 Seal: TPE
 O-ring: NBR
 Temperature range: -40°C / +100°C
 Protection class: IP 68



Progress MS Multi

Einteiliger Dichteinsatz
 nicht durchgehend isolierend

One-piece sealing insert
 not overall length insulated

G	>∅< min mm	>∅< max mm	⊗	⊗ mm	H mm	L mm	Art.-Nr. Art. No.	
Pg 9	2.0	3.0	2	18	22	6.0	1310.09.2.030	50
Pg 9	2.5	4.0	2	18	22	6.0	1310.09.2.040	50
Pg 9	3.5	5.0	2	18	22	6.0	1310.09.2.050	50
Pg 11	3.5	5.0	2	21	21	6.0	1310.11.2.050	50
Pg 11	4.5	6.0	2	21	21	6.0	1310.11.2.060	50
Pg 11	5.5	7.5	2	24	23	6.0	1310.11.2.075	50
Pg 11	3.5	5.0	3	21	21	6.0	1310.11.3.050	50
Pg 13	3.5	5.0	2	24	23	6.0	1310.13.2.050	50
Pg 13	4.5	6.0	2	24	23	6.0	1310.13.2.060	50
Pg 13	5.5	7.5	2	24	23	6.0	1310.13.2.075	50
Pg 13	3.5	5.0	3	24	23	6.0	1310.13.3.050	50
Pg 13	4.5	6.0	3	24	23	6.0	1310.13.3.060	50
Pg 13	5.2	6.5	3	24	23	6.0	1310.13.3.065	50
Pg 13	3.5	5.0	4	24	23	6.0	1310.13.4.050	50
Pg 13	4.5	6.0	4	24	23	6.0	1310.13.4.060	50
Pg 16	3.5	5.0	2	24	23	6.0	1310.16.2.050	50
Pg 16	4.5	6.0	2	24	23	6.0	1310.16.2.060	50
Pg 16	5.5	7.5	2	24	23	6.0	1310.16.2.075	50
Pg 16	6.7	9.0	2	30	28	6.0	1310.16.2.090	25
Pg 16	3.5	5.0	3	24	23	6.0	1310.16.3.050	50
Pg 16	4.5	6.0	3	24	23	6.0	1310.16.3.060	50
Pg 16	5.0	7.0	3	30	28	6.0	1310.16.3.070	25
Pg 16	3.5	5.0	4	24	23	6.0	1310.16.4.050	50
Pg 16	4.5	6.0	4	24	23	6.0	1310.16.4.060	50
Pg 16	5.5	7.0	4	30	28	6.0	1310.16.4.070	25
Pg 21	5.0	7.0	2	30	28	7.5	1310.21.2.070	25
Pg 21	6.7	9.0	2	30	28	7.5	1310.21.2.090	25
Pg 21	7.7	10.0	2	30	28	7.5	1310.21.2.100	25
Pg 21	9.0	11.5	2	36	28	7.5	1310.21.2.115	25
Pg 21	5.5	7.0	3	30	28	7.5	1310.21.3.070	25
Pg 21	6.8	9.0	3	30	28	7.5	1310.21.3.090	25
Pg 21	8.5	10.5	3	36	28	7.5	1310.21.3.105	25
Pg 21	5.5	7.0	4	30	28	7.5	1310.21.4.070	25
Pg 21	7.0	9.0	4	36	28	7.5	1310.21.4.090	25
Pg 21	4.8	6.0	6	30	28	7.5	1310.21.6.060	25
Pg 21	5.8	7.0	6	36	28	7.5	1310.21.6.070	25
Pg 29	7.5	9.0	3	38	28	8.0	1310.29.3.090	25

Weitere Ausführungen und Anschlussgewinde auf Anfrage

Further versions and entry threads are available upon request.

Erhältlich mit Dichteinsatz gemäss EN 45545. Bei Anfragen oder Bestellung bitte ein F vor die Artikelnummer setzen.

Available with sealing inserts conformity with EN 45545. When placing an inquiry, prefix the article number by the capital F.

Kabelverschraubungen Progress® Messing für mehrere Kabel Cable glands Progress® nickel-plated brass for installation of multiple cables

Langes Anschlussgewinde Pg | Long entry thread Pg

Material: Messing vernickelt
Dichtung: TPE
O-Ring: NBR
Einsatztemperatur: -40°C / +100°C
Schutzart: IP 68

Material: Nickel-plated brass
Seal: TPE
O-ring: NBR
Temperature range: -40°C / +100°C
Protection class: IP 68

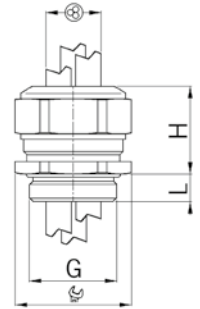

Progress MS Multi



Einteiliger Dichteinsatz
nicht durchgehend isolierend

One-piece sealing insert
not overall length insulated

G	>Ø< min mm	>Ø< max mm	⊗	⊗ mm	H mm	L mm	Art.-Nr. Art. No.	
Pg 9	2.0	3.0	2	18	22	10	1311.09.2.030	50
Pg 9	2.5	4.0	2	18	22	10	1311.09.2.040	50
Pg 9	3.5	5.0	2	18	22	10	1311.09.2.050	50
Pg 11	3.5	5.0	2	21	21	10	1311.11.2.050	50
Pg 11	4.5	6.0	2	21	21	10	1311.11.2.060	50
Pg 11	5.5	7.5	2	24	23	10	1311.11.2.075	50
Pg 11	3.5	5.0	3	21	21	10	1311.11.3.050	50
Pg 13	3.5	5.0	2	24	23	10	1311.13.2.050	50
Pg 13	4.5	6.0	2	24	23	10	1311.13.2.060	50
Pg 13	5.5	7.5	2	24	23	10	1311.13.2.075	50
Pg 13	3.5	5.0	3	24	23	10	1311.13.3.050	50
Pg 13	4.5	6.0	3	24	23	10	1311.13.3.060	50
Pg 13	5.2	6.5	3	24	23	10	1311.13.3.065	50
Pg 13	3.5	5.0	4	24	23	10	1311.13.4.050	50
Pg 13	4.5	6.0	4	24	23	10	1311.13.4.060	50
Pg 16	3.5	5.0	2	24	23	10	1311.16.2.050	50
Pg 16	4.5	6.0	2	24	23	10	1311.16.2.060	50
Pg 16	5.5	7.5	2	24	23	10	1311.16.2.075	50
Pg 16	6.7	9.0	2	30	28	10	1311.16.2.090	25
Pg 16	3.5	5.0	3	24	23	10	1311.16.3.050	50
Pg 16	4.5	6.0	3	24	23	10	1311.16.3.060	50
Pg 16	5.0	7.0	3	30	28	10	1311.16.3.070	25
Pg 16	3.5	5.0	4	24	23	10	1311.16.4.050	50
Pg 16	4.5	6.0	4	24	23	10	1311.16.4.060	50
Pg 16	5.5	7.0	4	30	28	10	1311.16.4.070	25
Pg 21	5.0	7.0	2	30	28	12	1311.21.2.070	25
Pg 21	6.7	9.0	2	30	28	12	1311.21.2.090	25
Pg 21	7.7	10.0	2	30	28	12	1311.21.2.100	25
Pg 21	9.0	11.5	2	36	28	12	1311.21.2.115	25
Pg 21	5.5	7.0	3	30	28	12	1311.21.3.070	25
Pg 21	6.8	9.0	3	30	28	12	1311.21.3.090	25
Pg 21	8.5	10.5	3	36	28	12	1311.21.3.105	25
Pg 21	5.5	7.0	4	30	28	12	1311.21.4.070	25
Pg 21	7.0	9.0	4	36	28	12	1311.21.4.090	25
Pg 21	4.8	6.0	6	30	28	12	1311.21.6.060	25
Pg 21	5.8	7.0	6	36	28	12	1311.21.6.070	25
Pg 29	7.5	9.0	3	38	28	12	1311.29.3.090	25



Weitere Ausführungen und Anschlussgewinde auf Anfrage

Further versions and entry threads are available upon request.

Erhältlich mit Dichteinsatz gemäss EN 45545. Bei Anfragen oder Bestellung bitte ein F vor die Artikelnummer setzen.

Available with sealing inserts conformity with EN 45545. When placing an inquiry, prefix the article number by the capital F.

Kabelverschraubungen Progress® Messing mit Dichteinsatz ohne Bohrung

Cable glands Progress® nickel-plated brass with sealing insert without drilled hole

Kurzes Anschlussgewinde metrisch | Short entry thread metric

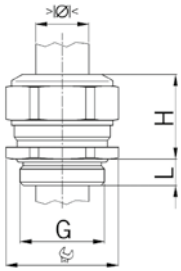

Material: Messing vernickelt
 Dichtung: NBR, ohne Bohrung
 O-Ring: NBR
 Einsatztemperatur: -40°C / +100°C
 Schutzart: IP 68 (bis 10 bar)
 Weitere Schutzart: IP 69

Material: Nickel-plated brass
 Seal: NBR, without drilled hole
 O-ring: NBR
 Temperature range: -40°C / +100°C
 Protection class: IP 68 (up to 10 bar)
 Further protection: IP 69

Progress MS NBR



Einteiliger Dichteinsatz ohne Bohrung
 nicht durchgehend isolierend

One-piece solid sealing insert
 not overall length insulated

G	> Ø < max mm	mm	H mm	L mm	i info	Art.-Nr. Art. No.	
M6x1.0	3.5	8	12	5	1	1000.06.30	50
M8x1.25	5.0	11	14	5	1	1000.08.30	50
M10x1.5	6.0	13	15	5	1	1000.10.30	50
M12x1.5	8.0	15	17	5	-	1000.12.30	50
M16x1.5	10.5	18	22	5	-	1000.17.30	50
M20x1.5	15.0	24	23	6	-	1000.20.30	50
M25x1.5	20.5	30	28	7	-	1000.25.30	25
M32x1.5	25.5	36	28	8	-	1000.32.30	25
M40x1.5	33.0	46	31	8	-	1000.40.30	10
M50x1.5	42.0	55	34	9	-	1000.50.30	10
M63x1.5	52.0	70	37	10	-	1000.63.30	5

1 = Metrisches Regelgewinde

1 = Metric coarse-pitch thread

Erhältlich mit Dichteinsatz gemäss EN 45545. Bei Anfragen oder Bestellung bitte ein F vor die Artikelnummer setzen.

Available with sealing inserts conformity with EN 45545. When placing an inquiry, prefix the article number by the capital F.

Technischer Hinweis

Technical note

Dichteinsätze ohne Bohrung lassen sich gut bearbeiten, wenn sie vorher auf mindestens -25°C gefroren wurden.

When frozen to at least -25°C, the solid sealing inserts are easy to drill.

Kurzes Anschlussgewinde Pg | Short entry thread Pg

Progress MS NBR



Einteiliger Dichteinsatz ohne Bohrung
 nicht durchgehend isolierend

One-piece solid sealing insert
 not overall length insulated

G	> Ø < max mm	mm	H mm	L mm	Art.-Nr. Art. No.	
Pg 7	8.0	15	17	6.0	1000.07.30	50
Pg 9	10.5	18	22	6.0	1000.09.30	50
Pg 11	12.0	21	21	6.0	1000.11.30	50
Pg 11	15.0	24	23	6.0	1000.11.20.30	50
Pg 13	15.0	24	23	6.0	1000.13.30	50
Pg 16	15.0	24	23	6.0	1000.16.30	50
Pg 16	18.5	30	28	6.0	1000.16.25.30	25
Pg 21	20.5	30	28	7.5	1000.21.30	25
Pg 21	23.0	36	28	7.5	1000.21.32.30	25
Pg 29	27.5	38	28	8.0	1000.29.30	25
Pg 29	33.0	46	31	8.0	1000.29.40.30	25
Pg 36	35.0	50	32	8.0	1000.36.30	10
Pg 36	42.0	55	34	8.0	1000.36.50.30	10
Pg 42	42.0	55	34	10.0	1000.42.30	10
Pg 48	49.0	65	37	11.0	1000.48.30	10

Erhältlich mit Dichteinsatz gemäss EN 45545. Bei Anfragen oder Bestellung bitte ein F vor die Artikelnummer setzen.

Available with sealing inserts conformity with EN 45545. When placing an inquiry, prefix the article number by the capital F.

Technischer Hinweis

Technical note

Dichteinsätze ohne Bohrung lassen sich gut bearbeiten, wenn sie vorher auf mindestens -25°C gefroren wurden.

When frozen to at least -25°C, the solid sealing inserts are easy to drill.

Kabelverschraubungen Progress® Messing mit Dichteinsatz ohne Bohrung

Cable glands Progress® nickel-plated brass with sealing insert without drilled hole

Kurzes Anschlussgewinde metrisch | Short entry thread metric

Material: Messing vernickelt
 Dichtung: FPM, ohne Bohrung
 O-Ring: FPM
 Einsatztemperatur: -40°C / +200°C
 Schutzart: IP 68 (bis 10 bar)
 Weitere Schutzart: IP 69

Material: Nickel-plated brass
 Seal: FPM, without drilled hole
 O-ring: FPM
 Temperature range: -40°C / +200°C
 Protection class: IP 68 (up to 10 bar)
 Further protection: IP 69

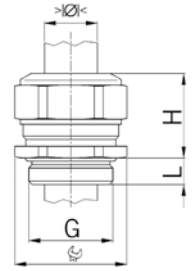

Progress MS FPM



Für hohe Temperaturen
 Einteiliger Dichteinsatz ohne Bohrung
 nicht durchgehend isolierend

For high temperature applications
 One-piece solid sealing insert
 not overall length insulated

G	>Ø< max mm	 mm	H mm	L mm	i info	Art.-Nr. Art. No.	
M6x1.0	3.5	8	12	5	1	1000.06.30.91	50
M8x1.25	5.0	11	14	5	1	1000.08.30.91	50
M10x1.5	6.0	13	15	5	1	1000.10.30.91	50
M12x1.5	8.0	15	17	5	-	1000.12.30.91	50
M16x1.5	10.5	18	22	5	-	1000.17.30.91	50
M20x1.5	15.0	24	23	6	-	1000.20.30.91	50
M25x1.5	20.5	30	28	7	-	1000.25.30.91	25
M32x1.5	25.5	36	28	8	-	1000.32.30.91	25
M40x1.5	33.0	46	31	8	-	1000.40.30.91	10
M50x1.5	42.0	55	34	9	-	1000.50.30.91	10
M63x1.5	52.0	70	37	10	-	1000.63.30.91	5



1 = Metrisches Regelgewinde

1 = Metric coarse-pitch thread

Technischer Hinweis

Technical note

Dichteinsätze ohne Bohrung lassen sich gut bearbeiten, wenn sie vorher auf mindestens -25°C gefroren wurden.

When frozen to at least -25°C, the solid sealing inserts are easy to drill.

Kurzes Anschlussgewinde Pg | Short entry thread Pg

Progress MS FPM



Für hohe Temperaturen
 Einteiliger Dichteinsatz ohne Bohrung
 nicht durchgehend isolierend

For high temperature applications
 One-piece solid sealing insert
 not overall length insulated

G	>Ø< max mm	 mm	H mm	L mm	Art.-Nr. Art. No.	
Pg 7	8.0	15	17	6.0	1000.07.30.91	50
Pg 9	10.5	18	22	6.0	1000.09.30.91	50
Pg 11	12.0	21	21	6.0	1000.11.30.91	50
Pg 11	15.0	24	23	6.0	1000.11.20.30.91	50
Pg 13	15.0	24	23	6.0	1000.13.30.91	50
Pg 16	15.0	24	23	6.0	1000.16.30.91	50
Pg 16	18.5	30	28	6.0	1000.16.25.30.91	25
Pg 21	20.5	30	28	7.5	1000.21.30.91	25
Pg 21	23.0	36	28	7.5	1000.21.32.30.91	25
Pg 29	27.5	38	28	8.0	1000.29.30.91	25
Pg 29	33.0	46	31	8.0	1000.29.40.30.91	25
Pg 36	35.0	50	32	8.0	1000.36.30.91	10
Pg 36	42.0	55	34	8.0	1000.36.50.30.91	10
Pg 42	42.0	55	34	10.0	1000.42.30.91	10
Pg 48	49.0	65	37	11.0	1000.48.30.91	10



Technischer Hinweis

Technical note

Dichteinsätze ohne Bohrung lassen sich gut bearbeiten, wenn sie vorher auf mindestens -25°C gefroren wurden.

When frozen to at least -25°C, the solid sealing inserts are easy to drill.

Kabelverschraubungen Progress® Messing für Flachkabel

Cable glands Progress® nickel-plated brass for flat cables

Kurzes Anschlussgewinde metrisch | Short entry thread metric

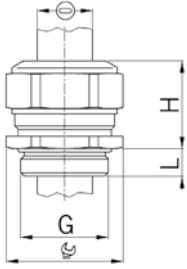

Material: Messing vernickelt
 Dichtung: TPE
 O-Ring: NBR
 Zugentlastung: Ausführung A nach EN 62444
 Einsatztemperatur: -40°C / +100°C
 Schutzart: IP 68

Material: Nickel-plated brass
 Seal: TPE
 O-ring: NBR
 Strain relief: Version A acc. to EN 62444
 Temperature range: -40°C / +100°C
 Protection class: IP 68



Progress MS FK



Einteiliger Dichteinsatz
 nicht durchgehend isolierend

One-piece sealing insert
 not overall length insulated

G	min mm	max mm	mm	H mm	L mm	Art.-Nr. Art. No.	
M16x1.5	7.3x2.5	9.0x4.2	18	22	5	1300.17.090.042	50
M20x1.5	10.5x2.5	13.0x5.0	24	23	6	1300.20.130.050	50
M20x1.5	12.5x2.5	15.0x5.0	24	23	6	1300.20.150.050	50
M25x1.5	16.0x4.0	19.0x7.0	30	28	7	1300.25.190.070	25
M32x1.5	19.0x3.0	22.0x6.0	36	28	8	1300.32.220.060	25
M32x1.5	19.0x5.0	22.0x8.0	36	28	8	1300.32.220.080	25
M40x1.5	23.0x4.0	26.0x7.0	46	31	8	1300.40.260.070	10
M40x1.5	23.5x6.0	26.5x9.0	46	31	8	1300.40.265.090	10
M40x1.5	25.0x3.0	28.0x6.0	46	31	8	1300.40.280.060	10
M40x1.5	27.0x7.0	30.0x10.0	46	31	8	1300.40.300.100	10
M40x1.5	29.0x6.0	32.0x9.0	46	31	8	1300.40.320.090	10
M40x1.5	30.0x3.5	33.0x6.5	46	31	8	1300.40.330.065	10
M50x1.5	31.0x8.5	34.0x11.5	55	34	9	1300.50.340.115	10
M50x1.5	34.0x4.0	37.0x7.0	55	34	9	1300.50.370.070	10
M50x1.5	36.5x2.5	40.0x6.0	55	34	9	1300.50.400.060	10
M50x1.5	36.5x10.0	40.0x13.5	55	34	9	1300.50.400.135	10
M50x1.5	38.5x10.5	42.0x14.0	55	34	9	1300.50.420.140	10
M63x1.5	42.0x10.0	46.0x14.0	70	37	10	1300.63.460.140	5
M63x1.5	42.5x2.0	46.5x6.0	70	37	10	1300.63.465.060	5

Erhältlich mit Dichteinsatz gemäss EN 45545. Bei Anfragen oder Bestellung bitte ein F vor die Artikelnummer setzen.

Available with sealing inserts conformity with EN 45545. When placing an inquiry, prefix the article number by the capital F.

Kabelverschraubungen Progress® Messing für Flachkabel

Cable glands Progress® nickel-plated brass for flat cables

Langes Anschlussgewinde metrisch | Long entry thread metric

Material: Messing vernickelt
 Dichtung: TPE
 O-Ring: NBR
 Zugentlastung: Ausführung A nach EN 62444
 Einsatztemperatur: -40°C / +100°C
 Schutzart: IP 68

Material: Nickel-plated brass
 Seal: TPE
 O-ring: NBR
 Strain relief: Version A acc. to EN 62444
 Temperature range: -40°C / +100°C
 Protection class: IP 68

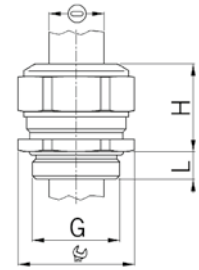

Progress MS FK



Einteiliger Dichteinsatz
 nicht durchgehend isolierend

One-piece sealing insert
 not overall length insulated

G	min mm	max mm	mm	H mm	L mm	Art.-Nr. Art. No.	
M16x1.5	7.3x2.5	9.0x4.2	18	22	10	1301.17.090.042	50
M20x1.5	10.5x2.5	13.0x5.0	24	23	10	1301.20.130.050	50
M20x1.5	12.5x2.5	15.0x5.0	24	23	10	1301.20.150.050	50
M25x1.5	16.0x4.0	19.0x7.0	30	28	11	1301.25.190.070	25
M32x1.5	19.0x3.0	22.0x6.0	36	28	13	1301.32.220.060	25
M32x1.5	19.0x5.0	22.0x8.0	36	28	13	1301.32.220.080	25
M40x1.5	23.0x4.0	26.0x7.0	46	31	13	1301.40.260.070	10
M40x1.5	23.5x6.0	26.5x9.0	46	31	13	1301.40.265.090	10
M40x1.5	25.0x3.0	28.0x6.0	46	31	13	1301.40.280.060	10
M40x1.5	27.0x7.0	30.0x10.0	46	31	13	1301.40.300.100	10
M40x1.5	29.0x6.0	32.0x9.0	46	31	13	1301.40.320.090	10
M40x1.5	30.0x3.5	33.0x6.5	46	31	13	1301.40.330.065	10
M50x1.5	31.0x8.5	34.0x11.5	55	34	14	1301.50.340.115	10
M50x1.5	34.0x4.0	37.0x7.0	55	34	14	1301.50.370.070	10
M50x1.5	36.5x2.5	40.0x6.0	55	34	14	1301.50.400.060	10
M50x1.5	36.5x10.0	40.0x13.5	55	34	14	1301.50.400.135	10
M50x1.5	38.5x10.5	42.0x14.0	55	34	14	1301.50.420.140	10
M63x1.5	42.0x10.0	46.0x14.0	70	37	14	1301.63.460.140	5
M63x1.5	42.5x2.0	46.5x6.0	70	37	14	1301.63.465.060	5

Erhältlich mit Dichteinsatz gemäss EN 45545. Bei Anfragen oder Bestellung bitte ein F vor die Artikelnummer setzen.

Available with sealing inserts conformity with EN 45545. When placing an inquiry, prefix the article number by the capital F.



Kabelverschraubungen Progress® Messing für Flachkabel

Cable glands Progress® nickel-plated brass for flat cables

Kurzes Anschlussgewinde Pg | Short entry thread Pg

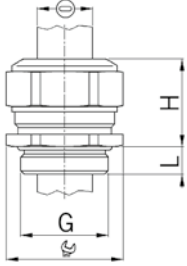

Material: Messing vernickelt
 Dichtung: TPE
 O-Ring: NBR
 Einsatztemperatur: -40°C / +100°C
 Schutzart: IP 68

Material: Nickel-plated brass
 Seal: TPE
 O-ring: NBR
 Temperature range: -40°C / +100°C
 Protection class: IP 68



Progress MS FK

Einteiliger Dichteinsatz
 nicht durchgehend isolierend

One-piece sealing insert
 not overall length insulated

G	min mm	max mm	mm	H mm	L mm	Art.-Nr. Art. No.	
Pg 9	7.3x2.5	9.0x4.2	18	22	6.0	1300.09.090.042	50
Pg 13	10.5x2.5	13.0x5.0	24	23	6.0	1300.13.130.050	50
Pg 13	12.5x2.5	15.0x5.0	24	23	6.0	1300.13.150.050	50
Pg 16	10.5x2.5	13.0x5.0	24	23	6.0	1300.16.130.050	50
Pg 16	12.5x2.5	15.0x5.0	24	23	6.0	1300.16.150.050	50
Pg 21	16.0x4.0	19.0x7.0	30	28	7.5	1300.21.190.070	25
Pg 21	19.0x3.0	22.0x6.0	36	28	7.5	1300.21.220.060	25
Pg 21	19.0x5.0	22.0x8.0	36	28	7.5	1300.21.220.080	25
Pg 29	23.0x4.0	26.0x7.0	46	31	8.0	1300.29.260.070	25
Pg 29	23.5x6.0	26.5x9.0	46	31	8.0	1300.29.265.090	25
Pg 29	25.0x3.0	28.0x6.0	46	31	8.0	1300.29.280.060	25
Pg 29	27.0x7.0	30.0x10.0	46	31	8.0	1300.29.300.100	25
Pg 29	29.0x6.0	32.0x9.0	46	31	8.0	1300.29.320.090	25
Pg 29	30.0x3.5	33.0x6.5	46	31	8.0	1300.29.330.065	25
Pg 42	31.0x8.5	34.0x11.5	55	34	10.0	1300.42.340.115	10
Pg 42	34.0x4.0	37.0x7.0	55	34	10.0	1300.42.370.070	10
Pg 42	36.5x2.5	40.0x6.0	55	34	10.0	1300.42.400.060	10
Pg 42	36.5x10.0	40.0x13.5	55	34	10.0	1300.42.400.135	10
Pg 42	38.5x10.5	42.0x14.0	55	34	10.0	1300.42.420.140	10
Pg 48	42.0x10.0	46.0x14.0	65	37	11.0	1300.48.460.140	10
Pg 48	42.5x2.0	46.5x6.0	65	37	11.0	1300.48.465.060	10

Langes Anschlussgewinde Pg | Long entry thread Pg



Progress MS FK

Einteiliger Dichteinsatz
 nicht durchgehend isolierend

One-piece sealing insert
 not overall length insulated

G	min mm	max mm	mm	H mm	L mm	Art.-Nr. Art. No.	
Pg 9	7.3x2.5	9.0x4.2	18	22	10	1301.09.090.042	50
Pg 13	10.5x2.5	13.0x5.0	24	23	10	1301.13.130.050	50
Pg 13	12.5x2.5	15.0x5.0	24	23	10	1301.13.150.050	50
Pg 16	10.5x2.5	13.0x5.0	24	23	10	1301.16.130.050	50
Pg 16	12.5x2.5	15.0x5.0	24	23	10	1301.16.150.050	50
Pg 21	16.0x4.0	19.0x7.0	30	28	12	1301.21.190.070	25
Pg 21	19.0x3.0	22.0x6.0	36	28	12	1301.21.220.060	25
Pg 21	19.0x5.0	22.0x8.0	36	28	12	1301.21.220.080	25
Pg 29	23.0x4.0	26.0x7.0	46	31	12	1301.29.260.070	25
Pg 29	23.5x6.0	26.5x9.0	46	31	12	1301.29.265.090	25
Pg 29	25.0x3.0	28.0x6.0	46	31	12	1301.29.280.060	25
Pg 29	27.0x7.0	30.0x10.0	46	31	12	1301.29.300.100	25
Pg 29	29.0x6.0	32.0x9.0	46	31	12	1301.29.320.090	25
Pg 29	30.0x3.5	33.0x6.5	46	31	12	1301.29.330.065	25
Pg 42	31.0x8.5	34.0x11.5	55	34	15	1301.42.340.115	10
Pg 42	34.0x4.0	37.0x7.0	55	34	15	1301.42.370.070	10
Pg 42	36.5x2.5	40.0x6.0	55	34	15	1301.42.400.060	10
Pg 42	36.5x10.0	40.0x13.5	55	34	15	1301.42.400.135	10
Pg 42	38.5x10.5	42.0x14.0	55	34	15	1301.42.420.140	10
Pg 48	42.0x10.0	46.0x14.0	65	37	15	1301.48.460.140	10
Pg 48	42.5x2.0	46.5x6.0	65	37	15	1301.48.465.060	10

Kabelverschraubungen Progress® Messing mit speziellem Anschlussgewinde

Cable glands Progress® nickel-plated brass with special entry thread

Speziell langes Anschlussgewinde metrisch | Extra-long entry thread metric

Material: Messing vernickelt
 Dichtung: TPE
 O-Ring: NBR
 Zugentlastung: Ausführung A nach EN 62444
 Einsatztemperatur: -40°C / +100°C
 Schutzart: IP 68 (bis 10 bar)
 Weitere Schutzart: IP 69

Material: Nickel-plated brass
 Seal: TPE
 O-ring: NBR
 Strain relief: Version A acc. to EN 62444
 Temperature range: -40°C / +100°C
 Protection class: IP 68 (up to 10 bar)
 Further protection: IP 69

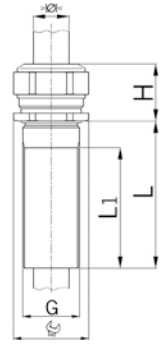

Progress MS L

Zweiteiliger Dichteinsatz nicht durchgehend isolierend		Two-piece sealing insert not overall length insulated								
G	> Ø < min mm	> Ø < max mm	> Ø < min mm	> Ø < max mm	mm	H mm	L1 mm	L mm	Art.-Nr. Art. No.	
M16x1.5	6.0	8.0	8.0	10.5	24/18	22	40	50	1100.17.50	10
M16x1.5	6.0	8.0	8.0	10.5	24/18	22	60	100	1100.17.51	10
M20x1.5	8.0	11.0	11.0	15.0	30/24	23	40	50	1100.20.50	10
M20x1.5	8.0	11.0	11.0	15.0	30/24	23	60	100	1100.20.51	10
M25x1.5	12.5	16.0	16.0	20.5	36/30	28	40	50	1100.25.50	10
M25x1.5	12.5	16.0	16.0	20.5	36/30	28	60	100	1100.25.51	10
M32x1.5	17.0	21.0	21.0	25.5	46/36	28	40	50	1100.32.50	10
M32x1.5	17.0	21.0	21.0	25.5	46/36	28	60	100	1100.32.51	10
M40x1.5	24.0	28.5	28.5	33.0	55/46	31	40	50	1100.40.50	10

Weitere Abmessungen auf Anfrage | Further dimensions upon request



Speziell langes Anschlussgewinde Pg | Specially long entry thread Pg

Material: Messing vernickelt
 Dichtung: TPE
 O-Ring: NBR
 Einsatztemperatur: -40°C / +100°C
 Schutzart: IP 68 (bis 10 bar)
 Weitere Schutzart: IP 69

Material: Nickel-plated brass
 Seal: TPE
 O-ring: NBR
 Temperature range: -40°C / +100°C
 Protection class: IP 68 (up to 10 bar)
 Further protection: IP 69

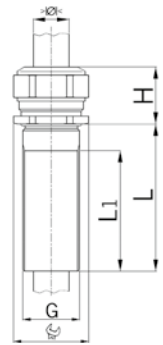

Progress MS L

Zweiteiliger Dichteinsatz nicht durchgehend isolierend		Two-piece sealing insert not overall length insulated								
G	> Ø < min mm	> Ø < max mm	> Ø < min mm	> Ø < max mm	mm	H mm	L1 mm	L mm	Art.-Nr. Art. No.	
Pg 11	5.5	8.5	8.5	12.0	27/21	21	40	50	1100.11.50	10
Pg 13	8.0	11.0	11.0	15.0	30/24	23	40	50	1100.13.50	10
Pg 16	8.0	11.0	11.0	15.0	30/24	23	40	50	1100.16.50	10
Pg 21	12.5	16.0	16.0	20.5	38/30	28	40	50	1100.21.50	10
Pg 29	19.0	23.0	23.0	27.5	46/38	28	40	50	1100.29.50	10

Weitere Abmessungen auf Anfrage | Further dimensions upon request



Kabelverschraubungen Progress® Messing mit speziellem Anschlussgewinde

Cable glands Progress® nickel-plated brass with special entry thread

Mit Innengewinde metrisch | With inner thread metric

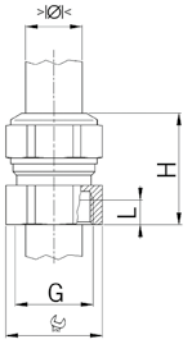

Material: Messing vernickelt
 Dichtung: TPE
 Zugentlastung: Ausführung A nach EN 62444
 Einsatztemperatur: -40°C / +100°C
 Schutzart: IP 68, wenn Anschlussgewinde abgedichtet
 Weitere Schutzart: IP 69

Material: Nickel-plated brass
 Seal: TPE
 Strain relief: Version A acc. to EN 62444
 Temperature range: -40°C / +100°C
 Protection class: IP 68, if the entry thread is sealed
 Further protection: IP 69



Progress MS IG



Anschluss mit Innengewinde metrisch
 Zweiteiliger Dichteinsatz
 nicht durchgehend isolierend

Internal thread metric
 Two-piece sealing insert
 not overall length insulated

G	>Ø< min mm	>Ø< max mm	>Ø< min mm	>Ø< max mm	Ø mm	H mm	L mm	Art.-Nr. Art. No.	
M16x1.5	6.0	8.0	8.0	10.5	18	28	6	1400.17	25
M20x1.5	8.0	11.0	11.0	15.0	24	31	6	1400.20	25
M25x1.5	12.5	16.0	16.0	20.5	30	40	10	1400.25	25

Erhältlich mit Dichteinsatz gemäss EN 45545. Bei Anfragen oder Bestellung bitte ein F vor die Artikelnummer setzen.

Available with sealing inserts conformity with EN 45545. When placing an inquiry, prefix the article number by the capital F.

Mit Innengewinde Pg | With inner thread Pg

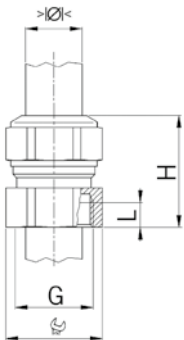

Material: Messing vernickelt
 Dichtung: TPE
 Einsatztemperatur: -40°C / +100°C
 Schutzart: IP 68, wenn Anschlussgewinde abgedichtet
 Weitere Schutzart: IP 69

Material: Nickel-plated brass
 Seal: TPE
 Temperature range: -40°C / +100°C
 Protection class: IP 68, if the entry thread is sealed
 Further protection: IP 69



Progress MS IG



Anschluss mit Innengewinde Pg
 Zweiteiliger Dichteinsatz
 nicht durchgehend isolierend

Internal thread Pg
 Two-piece sealing insert
 not overall length insulated

G	>Ø< min mm	>Ø< max mm	>Ø< min mm	>Ø< max mm	Ø mm	H mm	L mm	Art.-Nr. Art. No.	
Pg 11	5.5	8.5	8.5	12.0	21	28	6	1400.11	25
Pg 16	8.0	11.0	11.0	15.0	24	31	6	1400.16	25
Pg 21	12.5	16.0	16.0	20.5	30	40	10	1400.21	25

Erhältlich mit Dichteinsatz gemäss EN 45545. Bei Anfragen oder Bestellung bitte ein F vor die Artikelnummer setzen.

Available with sealing inserts conformity with EN 45545. When placing an inquiry, prefix the article number by the capital F.

Kabelverschraubungen Progress® Messing mit Knickschutz Cable glands Progress® nickel-plated brass with antikink protection

Kurzes Anschlussgewinde metrisch | Short entry thread metric

Kabelverschraubungen Progress® Messing mit Knickschutztülle EPDM

Material:	Messing vernickelt
Dichtung:	NBR
O-Ring:	NBR
Knickschutztülle:	EPDM
Zugentlastung:	Ausführung A nach EN 62444
Einsatztemperatur:	-40°C / +100°C
Schutzart:	IP 68
Weitere Schutzart:	IP 69

Cable glands Progress® nickel-plated brass with antikink nozzle EPDM

Material:	Nickel-plated brass
Seal:	NBR
O-ring:	NBR
antikink nozzle:	EPDM
Strain relief:	Version A acc. to EN 62444
Temperature range:	-40°C / +100°C
Protection class:	IP 68
Further protection:	IP 69

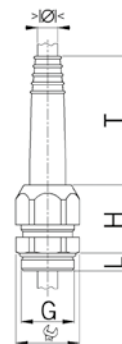

Einteiliger Dichteinsatz
nicht durchgehend isolierend

One-piece sealing insert
not overall length insulated

G	>Ø< min mm	>Ø< max mm	 mm	H mm	T mm	L mm	i info	Art.-Nr. Art. No.	
M8x1.25	3.8	4.8	11	12	25	6	1	1008.52	50
M10x1.5	4.0	6.0	16	20	35	6	1	1010.52	50
M12x1.5	4.0	6.0	16	20	35	6	-	1012.52	50
M16x1.5	6.0	8.8	20	24	45	6	-	1017.52	50
M20x1.5	9.0	11.0	24	28	65	6	-	1020.51	25
M20x1.5	10.5	13.0	24	28	73	6	-	1020.52	25
M25x1.5	13.0	16.5	32	33	92	7	-	1025.52	10

1 = Metrisches Regelgewinde (mit VDE Testreport)

1 = Metric coarse-pitch thread (with VDE test report)



Kurzes Anschlussgewinde Pg | Short entry thread Pg

Kabelverschraubungen Progress® Messing mit Knickschutztülle EPDM

Material:	Messing vernickelt
Dichtung:	NBR
O-Ring:	NBR
Knickschutztülle:	EPDM
Einsatztemperatur:	-40°C / +100°C
Schutzart:	IP 68
Weitere Schutzart:	IP 69

Cable glands Progress® nickel-plated brass with antikink nozzle EPDM

Material:	Nickel-plated brass
Seal:	NBR
O-ring:	NBR
antikink nozzle:	EPDM
Temperature range:	-40°C / +100°C
Protection class:	IP 68
Further protection:	IP 69

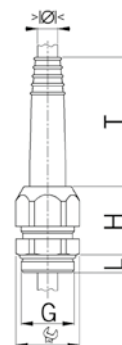

Einteiliger Dichteinsatz
nicht durchgehend isolierend

One-piece sealing insert
not overall length insulated

G	>Ø< min mm	>Ø< max mm	 mm	H mm	T mm	L mm	Art.-Nr. Art. No.	
Pg 7	4.0	6.0	16	20	35	6	1007.52	50
Pg 9	6.0	8.8	20	24	45	6	1009.52	50
Pg 11	6.0	8.8	20	24	45	6	1011.52	50
Pg 13	9.0	11.0	24	28	65	6	1013.51	25
Pg 13	10.5	13.0	24	28	73	6	1013.52	25
Pg 16	9.0	11.0	24	28	65	6	1016.51	25
Pg 16	10.5	13.0	24	28	73	6	1016.52	25
Pg 21	13.0	16.5	32	33	92	7.5	1021.51	10



Kabelverschraubungen Progress® Messing mit Knickschutzfeder

Cable glands Progress® nickel-plated brass with antikink spring

Kurzes Anschlussgewinde metrisch | Short entry thread metric

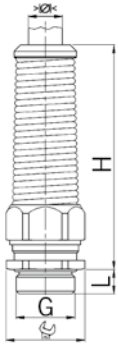

Material: Messing vernickelt
 Knickschutzfeder: Rostfreier Stahl A2
 Dichtung: TPE
 O-Ring: NBR
 Zugentlastung: Ausführung A nach EN 62444
 Einsatztemperatur: -40°C / +100°C
 Schutzart: IP 68 (bis 10 bar)
 Weitere Schutzart: IP 69

Material: Nickel-plated brass
 Antikink spring: Stainless steel A2
 Seal: TPE
 O-ring: NBR
 Strain relief: Version A acc. to EN 62444
 Temperature range: -40°C / +100°C
 Protection class: IP 68 (up to 10 bar)
 Further protection: IP 69



Progress MS FKN

Einteiliger Dichteinsatz durchgehend isolierend

One-piece sealing insert overall length insulated



G	>∅< min mm	>∅< max mm	∅ mm	H mm	L mm	i info	Art.-Nr. Art. No.	
M8x1.25	2.5	3.0	11	49	5	1	1060.08.52.030	10
M8x1.25	3.5	4.0	11	49	5	1	1060.08.52.040	10
M10x1.5	3.0	4.0	13	52	5	1	1060.10.52.040	10
M10x1.5	4.0	6.0	13	52	5	1	1060.10.52.060	10
M12x1.5	3.5	5.0	15	57	5	-	1060.12.52.050	10
M12x1.5	5.0	6.5	15	57	5	-	1060.12.52.065	10
M12x1.5	6.5	7.5	15	57	5	-	1060.12.52.075	10
M16x1.5	4.5	6.0	18	66	5	-	1060.17.52.060	10
M16x1.5	6.0	8.0	18	66	5	-	1060.17.52.080	10
M16x1.5	8.0	10.5	18	66	5	-	1060.17.52.105	10
M20x1.5	6.0	8.0	24	86	6	-	1060.20.52.080	10
M20x1.5	8.0	11.0	24	86	6	-	1060.20.52.110	10
M20x1.5	11.0	14.5	24	86	6	-	1060.20.52.145	10
M25x1.5	9.5	12.5	30	99	7	-	1060.25.52.125	10
M25x1.5	12.5	16.0	30	99	7	-	1060.25.52.160	10
M25x1.5	16.0	19.0	30	99	7	-	1060.25.52.190	10
M32x1.5	17.0	21.0	36	109	8	-	1060.32.52.210	5
M32x1.5	21.0	24.5	36	109	8	-	1060.32.52.245	5

1 = Metrisches Regelgewinde (mit VDE Testreport)

1 = Metric coarse-pitch thread (with VDE test report)

Erhältlich mit Dichteinsatz gemäss EN 45545. Bei Anfragen oder Bestellung bitte ein F vor die Artikelnummer setzen.

Available with sealing inserts conformity with EN 45545. When placing an inquiry, prefix the article number by the capital F.

Auf Anfrage lieferbar:

Available on request:

- Kurzes Anschlussgewinde mit kurzem ein- oder zweiteiligem Dichteinsatz.

- Short entry thread with short one-piece or two-piece sealing insert.

- Langes Anschlussgewinde mit kurzem oder durchgehend isolierendem ein- oder zweiteiligem Dichteinsatz.

- Long entry thread with short or full-length insulating one-piece or two-piece sealing insert.

Progress MS FKN

Zweiteiliger Dichteinsatz durchgehend isolierend

Two-piece sealing insert overall length insulated



G	>∅< min mm	>∅< max mm	>∅< min mm	>∅< max mm	∅ mm	H mm	L mm	Art.-Nr. Art. No.	
M16x1.5	6.0	8.0	8.0	10.5	18	66	5	1060.17.52	10
M20x1.5	8.0	11.0	11.0	14.5	24	86	6	1060.20.52	10
M25x1.5	12.5	16.0	16.0	19.0	30	99	7	1060.25.52	10
M32x1.5	17.0	20.0	20.0	24.5	36	109	8	1060.32.52	5

Erhältlich mit Dichteinsatz gemäss EN 45545. Bei Anfragen oder Bestellung bitte ein F vor die Artikelnummer setzen.

Available with sealing inserts conformity with EN 45545. When placing an inquiry, prefix the article number by the capital F.

Auf Anfrage lieferbar:

Available on request:

- Kurzes Anschlussgewinde mit kurzem ein- oder zweiteiligem Dichteinsatz.

- Short entry thread with short one-piece or two-piece sealing insert.

- Langes Anschlussgewinde mit kurzem oder durchgehend isolierendem ein- oder zweiteiligem Dichteinsatz.

- Long entry thread with short or full-length insulating one-piece or two-piece sealing insert.

Kabelverschraubungen Progress® Messing mit Knickschutzfeder

Cable glands Progress® nickel-plated brass with antikink spring

Kurzes Anschlussgewinde Pg | Short entry thread Pg

Material: Messing vernickelt
 Knickschutzfeder: Rostfreier Stahl A2
 Dichtung: TPE
 O-Ring: NBR
 Einsatztemperatur: -40°C / +100°C
 Schutzart: IP 68 (bis 10 bar)
 Weitere Schutzart: IP 69

Material: Nickel-plated brass
 Antikink spring: Stainless steel A2
 Seal: TPE
 O-ring: NBR
 Temperature range: -40°C / +100°C
 Protection class: IP 68 (up to 10 bar)
 Further protection: IP 69

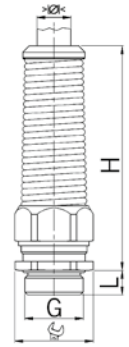

Progress MS FKN



Einteiliger Dichteinsatz
 durchgehend isolierend

One-piece sealing insert
 overall length insulated

G	> Ø < min mm	> Ø < max mm	mm	H mm	L mm	Art.-Nr. Art. No.	
Pg 7	3.5	5.0	15	57	6	1060.07.52.050	10
Pg 7	5.0	6.5	15	57	6	1060.07.52.065	10
Pg 7	6.5	7.5	15	57	6	1060.07.52.075	10
Pg 9	4.5	6.0	18	66	6	1060.09.52.060	10
Pg 9	6.0	8.0	18	66	6	1060.09.52.080	10
Pg 9	8.0	10.5	18	66	6	1060.09.52.105	10
Pg 11	4.5	6.0	18/21	66	6	1060.11.52.060	10
Pg 11	6.0	8.0	18/21	66	6	1060.11.52.080	10
Pg 11	8.0	10.5	18/21	66	6	1060.11.52.105	10
Pg 13	6.0	8.0	24	86	6	1060.13.52.080	10
Pg 13	8.0	11.0	24	86	6	1060.13.52.110	10
Pg 13	11.0	14.5	24	86	6	1060.13.52.145	10
Pg 16	6.0	8.0	24	86	6	1060.16.52.080	10
Pg 16	8.0	11.0	24	86	6	1060.16.52.110	10
Pg 16	11.0	14.5	24	86	6	1060.16.52.145	10
Pg 21	9.5	12.5	30	99	7.5	1060.21.52.125	5
Pg 21	12.5	16.0	30	99	7.5	1060.21.52.160	5
Pg 21	16.0	19.0	30	99	7.5	1060.21.52.190	5



Erhältlich mit Dichteinsatz gemäss EN 45545. Bei Anfragen oder Bestellung bitte ein F vor die Artikelnummer setzen.

Available with sealing inserts conformity with EN 45545. When placing an inquiry, prefix the article number by the capital F.

Auf Anfrage lieferbar:

Available on request:

- Kurzes Anschlussgewinde mit kurzem ein- oder zweiteiligem Dichteinsatz.
- Langes Anschlussgewinde mit kurzem oder durchgehend isolierendem ein- oder zweiteiligem Dichteinsatz.

- Short entry thread with short one-piece or two-piece sealing insert.
- Long entry thread with short or full-length insulating one-piece or two-piece sealing insert.

Progress MS FKN



Zweiteiliger Dichteinsatz
 durchgehend isolierend

Two-piece sealing insert
 overall length insulated

G	> Ø < min mm	> Ø < max mm	> Ø < min mm	> Ø < max mm	mm	H mm	L mm	Art.-Nr. Art. No.	
Pg 9	6.0	8.0	8.0	10.5	18	66	6	1060.09.52	10
Pg 11	6.0	8.0	8.0	10.5	18/21	66	6	1060.11.52	10
Pg 13	8.0	11.0	11.0	14.5	24	86	6	1060.13.52	10
Pg 16	8.0	11.0	11.0	14.5	24	86	6	1060.16.52	10
Pg 21	12.5	16.0	16.0	19.0	30	99	7.5	1060.21.52	5



Erhältlich mit Dichteinsatz gemäss EN 45545. Bei Anfragen oder Bestellung bitte ein F vor die Artikelnummer setzen.

Available with sealing inserts conformity with EN 45545. When placing an inquiry, prefix the article number by the capital F.

Auf Anfrage lieferbar:

Available on request:

- Kurzes Anschlussgewinde mit kurzem ein- oder zweiteiligem Dichteinsatz.
- Langes Anschlussgewinde mit kurzem oder durchgehend isolierendem ein- oder zweiteiligem Dichteinsatz.

- Short entry thread with short one-piece or two-piece sealing insert.
- Long entry thread with short or full-length insulating one-piece or two-piece sealing insert.

Kabelverschraubungen Progress® Messing mit Klemmbacken

Cable glands Progress® nickel-plated brass with clamps

Kurzes Anschlussgewinde metrisch | Short entry thread metric

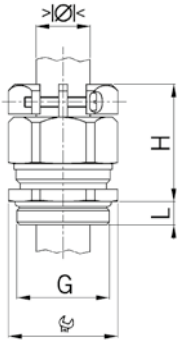

Material: Messing vernickelt
 Klemmschrauben: Rostfreier Stahl A2
 Dichtung: TPE
 O-Ring: NBR
 Zugentlastung: Ausführung B nach EN 62444
 Einsatztemperatur: -40°C / +100°C
 Schutzart: IP 68 (bis 10 bar)
 Weitere Schutzart: IP 69

Material: Nickel-plated brass
 Screws: Stainless steel A2
 Seal: TPE
 O-ring: NBR
 Strain relief: Version B acc. to EN 62444
 Temperature range: -40°C / +100°C
 Protection class: IP 68 (up to 10 bar)
 Further protection: IP 69



Progress MS KB

Einteiliger Dichteinsatz
 nicht durchgehend isolierend

One-piece sealing insert
 not overall length insulated

G	>Ø< min mm	>Ø< max mm	 mm	H mm	L mm	i info	Art.-Nr. Art. No.	
M10x1.5	3.0	4.0	13/16	24	5	1	1800.10.03.040	50
M10x1.5	4.0	6.0	13/16	24	5	1	1800.10.03.060	50
M12x1.5	5.0	6.5	15/16	26	5	-	1800.12.03.065	50
M12x1.5	6.5	8.0	15/16	26	5	-	1800.12.03.080	50

1 = Metrisches Regelgewinde (mit VDE Testreport)

1 = Metric coarse-pitch thread (with VDE test report)

Erhältlich mit Dichteinsatz gemäss EN 45545. Bei Anfragen oder Bestellung bitte ein F vor die Artikelnummer setzen.

Available with sealing inserts conformity with EN 45545. When placing an inquiry, prefix the article number by the capital F.



Progress MS KB

Zweiteiliger Dichteinsatz
 nicht durchgehend isolierend

Two-piece sealing insert
 not overall length insulated

G	>Ø< min mm	>Ø< max mm	>Ø< min mm	>Ø< max mm	 mm	H mm	L mm	Art.-Nr. Art. No.	
M16x1.5	6.0	8.0	8.0	10.5	18/19	30	5	1800.17.03.105	50
M20x1.5	8.0	11.0	11.0	15.0	24	31	6	1800.20.03.150	50
M25x1.5	12.5	16.0	16.0	20.5	30	35	7	1800.25.03.205	25
M32x1.5	17.0	21.0	21.0	25.5	36	40	8	1800.32.03.255	25
M40x1.5	24.0	28.5	28.5	33.0	46	44	8	1800.40.03.330	10
M50x1.5	33.0	37.0	37.0	42.0	55	49	9	1800.50.03.410	10
M63x1.5	40.0	46.0	46.0	52.0	70	55	10	1800.63.03.520	5
M75x1.5	50.0	56.0	56.0	63.0	80	56	11	1800.75.03.630	1

Erhältlich mit Dichteinsatz gemäss EN 45545. Bei Anfragen oder Bestellung bitte ein F vor die Artikelnummer setzen.

Available with sealing inserts conformity with EN 45545. When placing an inquiry, prefix the article number by the capital F.



Kabelverschraubungen Progress® Messing mit Klemmbacken

Cable glands Progress® nickel-plated brass with clamps

Langes Anschlussgewinde metrisch | Long entry thread metric

Material: Messing vernickelt
 Klemmschrauben: Rostfreier Stahl A2
 Dichtung: TPE
 O-Ring: NBR
 Zugentlastung: Ausführung B nach EN 62444
 Einsatztemperatur: -40°C / +100°C
 Schutzart: IP 68 (bis 10 bar)
 Weitere Schutzart: IP 69

Material: Nickel-plated brass
 Screws: Stainless steel A2
 Seal: TPE
 O-ring: NBR
 Strain relief: Version B acc. to EN 62444
 Temperature range: -40°C / +100°C
 Protection class: IP 68 (up to 10 bar)
 Further protection: IP 69

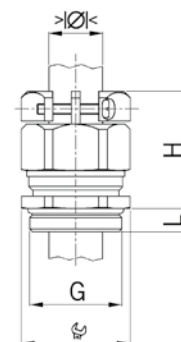

Progress MS KB

Einteiliger Dichteinsatz
 nicht durchgehend isolierend

One-piece sealing insert
 not overall length insulated

G	>Ø< min mm	>Ø< max mm	 mm	H mm	L mm	i info	Art.-Nr. Art. No.	
M10x1.5	3.0	4.0	13/16	24	10	1	1800.10.13.040	50
M10x1.5	4.0	6.0	13/16	24	10	1	1800.10.13.060	50
M12x1.5	5.0	6.5	15/16	26	10	-	1800.12.13.065	50
M12x1.5	6.5	8.0	15/16	26	10	-	1800.12.13.080	50



1 = Metrisches Regelgewinde (mit VDE Testreport)

1 = Metric coarse-pitch thread (with VDE test report)

Erhältlich mit Dichteinsatz gemäss EN 45545. Bei Anfragen oder Bestellung bitte ein F vor die Artikelnummer setzen.

Available with sealing inserts conformity with EN 45545. When placing an inquiry, prefix the article number by the capital F.

Progress MS KB

Zweiteiliger Dichteinsatz
 nicht durchgehend isolierend

Two-piece sealing insert
 not overall length insulated

G	>Ø< min mm	>Ø< max mm	>Ø< min mm	>Ø< max mm	 mm	H mm	L mm	Art.-Nr. Art. No.	
M16x1.5	6.0	8.0	8.0	10.5	18/19	30	10	1800.17.13.105	50
M20x1.5	8.0	11.0	11.0	15.0	24	31	10	1800.20.13.150	50
M25x1.5	12.5	16.0	16.0	20.5	30	35	11	1800.25.13.205	25
M32x1.5	17.0	21.0	21.0	25.5	36	40	13	1800.32.13.255	25
M40x1.5	24.0	28.5	28.5	33.0	46	44	13	1800.40.13.330	10
M50x1.5	33.0	37.0	37.0	42.0	55	49	14	1800.50.13.410	10
M63x1.5	40.0	46.0	46.0	52.0	70	55	14	1800.63.13.520	5
M75x1.5	50.0	56.0	56.0	63.0	80	56	15	1800.75.13.630	1



Erhältlich mit Dichteinsatz gemäss EN 45545. Bei Anfragen oder Bestellung bitte ein F vor die Artikelnummer setzen.

Available with sealing inserts conformity with EN 45545. When placing an inquiry, prefix the article number by the capital F.

Kabelverschraubungen Progress® Messing mit Klemmbacken

Cable glands Progress® nickel-plated brass with clamps

Kurzes Anschlussgewinde Pg | Short entry thread Pg

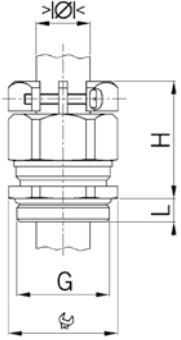

Material: Messing vernickelt
 Klemmschrauben: Rostfreier Stahl A2
 Dichtung: TPE
 O-Ring: NBR
 Einsatztemperatur: -40°C / +100°C
 Schutzart: IP 68 (bis 10 bar)
 Weitere Schutzart: IP 69

Material: Nickel-plated brass
 Screws: Stainless steel A2
 Seal: TPE
 O-ring: NBR
 Temperature range: -40°C / +100°C
 Protection class: IP 68 (up to 10 bar)
 Further protection: IP 69

Progress MS KB



Einteiliger Dichteinsatz
 nicht durchgehend isolierend

One-piece sealing insert
 not overall length insulated

G	> Ø < min mm	> Ø < max mm	mm	H mm	L mm	Art.-Nr. Art. No.	
Pg 7	5.0	6.5	15/16	26	6	1800.07.03.065	50
Pg 7	6.5	8.0	15/16	26	6	1800.07.03.080	50

Erhältlich mit Dichteinsatz gemäss EN 45545. Bei Anfragen oder Bestellung bitte ein F vor die Artikelnummer setzen.

Available with sealing inserts conformity with EN 45545. When placing an inquiry, prefix the article number by the capital F.

Progress MS KB



Zweiteiliger Dichteinsatz
 nicht durchgehend isolierend

Two-piece sealing insert
 not overall length insulated

G	> Ø < min mm	> Ø < max mm	> Ø < min mm	> Ø < max mm	mm	H mm	L mm	Art.-Nr. Art. No.	
Pg 9	6.0	8.0	8.0	10.5	18/19	30	6	1800.09.03.105	50
Pg 11	5.5	8.5	8.5	12.0	21	31	6	1800.11.03.120	50
Pg 13	8.0	11.0	11.0	15.0	24	31	6	1800.13.03.150	50
Pg 16	8.0	11.0	11.0	15.0	24	31	6	1800.16.03.150	50
Pg 21	12.5	16.0	16.0	20.5	30	35	7	1800.21.03.205	25
Pg 29	19.0	23.0	23.0	27.5	38	40	8	1800.29.03.275	25
Pg 36	26.0	30.5	30.5	35.0	50	47	8	1800.36.03.350	10
Pg 42	33.0	37.0	37.0	42.0	55	49	10	1800.42.03.410	10
Pg 48	37.0	43.0	43.0	49.0	65	51	11	1800.48.03.490	5

Erhältlich mit Dichteinsatz gemäss EN 45545. Bei Anfragen oder Bestellung bitte ein F vor die Artikelnummer setzen.

Available with sealing inserts conformity with EN 45545. When placing an inquiry, prefix the article number by the capital F.

Kabelverschraubungen Progress® Messing mit Klemmbacken

Cable glands Progress® nickel-plated brass with clamps

Langes Anschlussgewinde Pg | Long entry thread Pg

Material: Messing vernickelt
 Klemmschrauben: Rostfreier Stahl A2
 Dichtung: TPE
 O-Ring: NBR
 Einsatztemperatur: -40°C / +100°C
 Schutzart: IP 68 (bis 10 bar)
 Weitere Schutzart: IP 69

Material: Nickel-plated brass
 Screws: Stainless steel A2
 Seal: TPE
 O-ring: NBR
 Temperature range: -40°C / +100°C
 Protection class: IP 68 (up to 10 bar)
 Further protection: IP 69

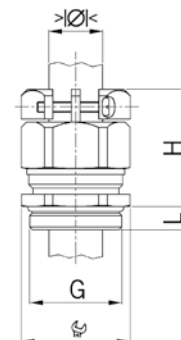

Progress MS KB



Einteiliger Dichteinsatz
 nicht durchgehend isolierend

One-piece sealing insert
 not overall length insulated

G	> Ø < min mm	> Ø < max mm	⌀ mm	H mm	L mm	Art.-Nr. Art. No.	
Pg 7	5.0	6.5	15/16	26	10	1800.07.13.065	50
Pg 7	6.5	8.0	15/16	26	10	1800.07.13.080	50

Erhältlich mit Dichteinsatz gemäss EN 45545. Bei Anfragen oder Bestellung bitte ein F vor die Artikelnummer setzen.

Available with sealing inserts conformity with EN 45545. When placing an inquiry, prefix the article number by the capital F.



Progress MS KB



Zweiteiliger Dichteinsatz
 nicht durchgehend isolierend

Two-piece sealing insert
 not overall length insulated

G	> Ø < min mm	> Ø < max mm	> Ø < min mm	> Ø < max mm	⌀ mm	H mm	L mm	Art.-Nr. Art. No.	
Pg 9	6.0	8.0	8.0	10.5	18/19	30	10	1800.09.13.105	50
Pg 11	5.5	8.5	8.5	12.0	21	31	10	1800.11.13.120	50
Pg 13	8.0	11.0	11.0	15.0	24	31	10	1800.13.13.150	50
Pg 16	8.0	11.0	11.0	15.0	24	31	10	1800.16.13.150	50
Pg 21	12.5	16.0	16.0	20.5	30	35	12	1800.21.13.205	25
Pg 29	19.0	23.0	23.0	27.5	38	40	12	1800.29.13.275	25
Pg 36	26.0	30.5	30.5	35.0	50	47	15	1800.36.13.350	10
Pg 42	33.0	37.0	37.0	42.0	55	49	15	1800.42.13.410	10
Pg 48	37.0	43.0	43.0	49.0	65	51	15	1800.48.13.490	5

Erhältlich mit Dichteinsatz gemäss EN 45545. Bei Anfragen oder Bestellung bitte ein F vor die Artikelnummer setzen.

Available with sealing inserts conformity with EN 45545. When placing an inquiry, prefix the article number by the capital F.



Kabelverschraubungen Progress® Messing mit Klemmbacken

Cable glands Progress® nickel-plated brass with clamps

Anschlussgewinde metrisch | Entry thread metric

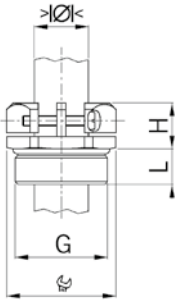

Material: Messing vernickelt
 Klemmschrauben: Rostfreier Stahl A2
 Zugentlastung: Ausführung B nach EN 62444
 Einsatztemperatur: -50°C / +300°C
 Schutzart: IP 20

Material: Nickel-plated brass
 Screws: Stainless steel A2
 Strain relief: Version B acc. to EN 62444
 Temperature range: -50°C / +300°C
 Protection class: IP 20



Progress MS KBST



Mechanische Zugentlastung B						Mechanical strain relief B	
G	> Ø < min mm	> Ø < max mm	mm	H mm	L mm	Art.-Nr. Art. No.	
M12x1.5	5.0	8.0	16	10	10	1812.02	50
M16x1.5	6.0	10.5	19	11	10	1817.02	50
M20x1.5	8.0	15.0	24	12	10	1820.02	50
M25x1.5	12.5	20.5	30	13	11	1825.02	25
M32x1.5	17.0	25.5	36	15	13	1832.02	25
M40x1.5	24.0	33.0	46	17	13	1840.02	10

Kabelverschraubungen Progress® Messing mit Klemmbacken

Cable glands Progress® nickel-plated brass with clamps

Anschlussgewinde Pg | Entry thread Pg

Material: Messing vernickelt
 Klemmschrauben: Rostfreier Stahl A2
 Einsatztemperatur: -50°C / +300°C
 Schutzart: IP 20

Material: Nickel-plated brass
 Screws: Stainless steel A2
 Temperature range: -50°C / +300°C
 Protection class: IP 20

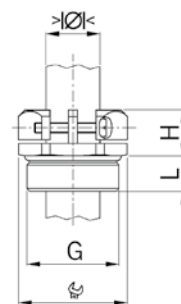

Progress MS KBST



Mechanische Zugentlastung B

Mechanical strain relief B

G	>Ø<		 mm	H mm	L mm	Art.-Nr. Art. No.	
	min mm	max mm					
Pg 7	4.0	8.0	17	10	6	1807.02	50
Pg 9	6.0	10.0	20	11	6	1809.02	50
Pg 11	6.0	12.0	22	11	6	1811.02	50
Pg 13	7.0	15.0	24	11	7	1813.02	50
Pg 16	9.0	17.0	27	12	7	1816.02	50
Pg 21	12.0	22.0	35	14	8	1821.02	25
Pg 29	18.0	30.0	42	15	8	1829.02	25
Pg 36	24.0	36.0	55	18	10	1836.02	10



Kabelverschraubungen Progress® Messing mit Trompete

Cable glands Progress® nickel-plated brass with trumpet

Kurzes Anschlussgewinde metrisch | Short entry thread metric

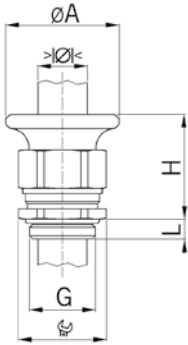

Material: Messing vernickelt
 Dichtung: TPE
 O-Ring: NBR
 Zugentlastung: Ausführung A nach EN 62444
 Einsatztemperatur: -40°C / +100°C
 Schutzart: IP 68 (bis 10 bar)
 Weitere Schutzart: IP 69

Material: Nickel-plated brass
 Seal: TPE
 O-ring: NBR
 Strain relief: Version A acc. to EN 62444
 Temperature range: -40°C / +100°C
 Protection class: IP 68 (up to 10 bar)
 Further protection: IP 69



Progress MS T

Zweiteiliger Dichteinsatz
 nicht durchgehend isolierend

Two-piece sealing insert
 not overall length insulated

G	> < < min mm	> < < max mm	> < < min mm	> < < max mm	mm	$\varnothing A$ mm	H mm	L mm	Art.-Nr. Art. No.	
M16x1.5	6.0	8.0	8.0	10.5	18	28	31	5	1800.10.17	50
M20x1.5	8.0	11.0	11.0	15.0	24	34	32	6	1800.10.20	50
M25x1.5	12.5	16.0	16.0	20.5	30	44	38	7	1800.10.25	25
M32x1.5	17.0	21.0	21.0	25.5	36	50	44	8	1800.10.32	25
M40x1.5	24.0	28.5	28.5	33.0	46	57	46	8	1800.10.40	10

Erhältlich mit Dichteinsatz gemäss EN 45545. Bei Anfragen oder Bestellung bitte ein F vor die Artikelnummer setzen.

Available with sealing inserts conformity with EN 45545. When placing an inquiry, prefix the article number by the capital F.



Langes Anschlussgewinde metrisch | Long entry thread metric



Progress MS T

Zweiteiliger Dichteinsatz
 nicht durchgehend isolierend

Two-piece sealing insert
 not overall length insulated

G	> < < min mm	> < < max mm	> < < min mm	> < < max mm	mm	$\varnothing A$ mm	H mm	L mm	Art.-Nr. Art. No.	
M16x1.5	6.0	8.0	8.0	10.5	18	28	31	10	1800.11.17	50
M20x1.5	8.0	11.0	11.0	15.0	24	34	32	10	1800.11.20	50
M25x1.5	12.5	16.0	16.0	20.5	30	44	38	11	1800.11.25	25
M32x1.5	17.0	21.0	21.0	25.5	36	50	44	13	1800.11.32	25
M40x1.5	24.0	28.5	28.5	33.0	46	57	46	13	1800.11.40	10

Erhältlich mit Dichteinsatz gemäss EN 45545. Bei Anfragen oder Bestellung bitte ein F vor die Artikelnummer setzen.

Available with sealing inserts conformity with EN 45545. When placing an inquiry, prefix the article number by the capital F.



Kabelverschraubungen Progress® Messing mit Trompete

Cable glands Progress® nickel-plated brass with trumpet

Kurzes Anschlussgewinde Pg | Short entry thread Pg

Material: Messing vernickelt
 Dichtung: TPE
 O-Ring: NBR
 Einsatztemperatur: -40°C / +100°C
 Schutzart: IP 68 (bis 10 bar)
 Weitere Schutzart: IP 69

Material: Nickel-plated brass
 Seal: TPE
 O-ring: NBR
 Temperature range: -40°C / +100°C
 Protection class: IP 68 (up to 10 bar)
 Further protection: IP 69

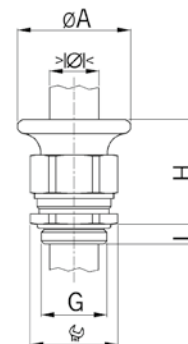

Progress MS T



Zweiteiliger Dichteinsatz
 nicht durchgehend isolierend

Two-piece sealing insert
 not overall length insulated

G	>Ø< min mm	>Ø< max mm	>Ø< min mm	>Ø< max mm	⌀ mm	ØA mm	H mm	L mm	Art.-Nr. Art. No.	
Pg 9	6.0	8.0	8.0	10.5	18	28	31	6	1800.10.09	50
Pg 11	5.5	8.5	8.5	12.0	21	30	31	6	1800.10.11	50
Pg 13	8.0	11.0	11.0	15.0	24	34	32	6	1800.10.13	50
Pg 16	8.0	11.0	11.0	15.0	24	34	32	6	1800.10.16	50
Pg 21	12.5	16.0	16.0	20.5	30	44	38	7.5	1800.10.21	25
Pg 29	19.0	23.0	23.0	27.5	38	50	44	8	1800.10.29	10

Erhältlich mit Dichteinsatz gemäss EN 45545. Bei Anfragen oder Bestellung bitte ein F vor die Artikelnummer setzen.

Available with sealing inserts conformity with EN 45545. When placing an inquiry, prefix the article number by the capital F.



Langes Anschlussgewinde Pg | Long entry thread Pg

Progress MS T



Zweiteiliger Dichteinsatz
 nicht durchgehend isolierend

Two-piece sealing insert
 not overall length insulated

G	>Ø< min mm	>Ø< max mm	>Ø< min mm	>Ø< max mm	⌀ mm	ØA mm	H mm	L mm	Art.-Nr. Art. No.	
Pg 9	6.0	8.0	8.0	10.5	18	28	31	10	1800.11.09	50
Pg 11	5.5	8.5	8.5	12.0	21	30	31	10	1800.11.11	50
Pg 13	8.0	11.0	11.0	15.0	24	34	32	10	1800.11.13	50
Pg 16	8.0	11.0	11.0	15.0	24	34	32	10	1800.11.16	50
Pg 21	12.5	16.0	16.0	20.5	30	44	38	12	1800.11.21	25
Pg 29	19.0	23.0	23.0	27.5	38	50	44	12	1800.11.29	10

Erhältlich mit Dichteinsatz gemäss EN 45545. Bei Anfragen oder Bestellung bitte ein F vor die Artikelnummer setzen.

Available with sealing inserts conformity with EN 45545. When placing an inquiry, prefix the article number by the capital F.



Kabelverschraubungen Progress® Messing mit Trompete und Klemmbacken

Cable glands Progress® nickel-plated brass with trumpet and clamps

Kurzes Anschlussgewinde metrisch | Short entry thread metric

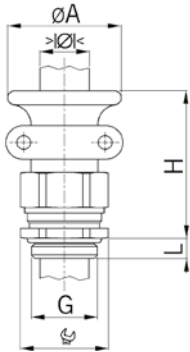

Material: Messing vernickelt
 Klemmschrauben: Rostfreier Stahl A2
 Dichtung: TPE
 O-Ring: NBR
 Zugentlastung: Ausführung B nach EN 62444
 Einsatztemperatur: -40°C / +100°C
 Schutzart: IP 68 (bis 10 bar)
 Weitere Schutzart: IP 69

Material: Nickel-plated brass
 Screws: Stainless steel A2
 Seal: TPE
 O-ring: NBR
 Strain relief: Version B acc. to EN 62444
 Temperature range: -40°C / +100°C
 Protection class: IP 68 (up to 10 bar)
 Further protection: IP 69



Progress MS T+KB

Zweiteiliger Dichteinsatz
 nicht durchgehend isolierend

Two-piece sealing insert
 not overall length insulated



G	> Ø < min mm	> Ø < max mm	> Ø < min mm	> Ø < max mm	⌀ mm	ØA mm	H mm	L mm	Art.-Nr. Art. No.	
M16x1.5	6.0	8.0	8.0	10.5	18	28	43	5	1801.10.17	50
M20x1.5	8.0	11.0	11.0	15.0	24	34	46	6	1801.10.20	50
M25x1.5	12.5	16.0	16.0	20.5	30	44	52	7	1801.10.25	25
M32x1.5	17.0	21.0	21.0	25.5	36	50	59	8	1801.10.32	10
M40x1.5	24.0	28.5	28.5	33.0	46	57	59	8	1801.10.40	5

Erhältlich mit Dichteinsatz gemäss EN 45545. Bei Anfragen oder Bestellung bitte ein F vor die Artikelnummer setzen.

Available with sealing inserts conformity with EN 45545. When placing an inquiry, prefix the article number by the capital F.

Langes Anschlussgewinde metrisch | Long entry thread metric

Progress MS T+KB

Zweiteiliger Dichteinsatz
 nicht durchgehend isolierend

Two-piece sealing insert
 not overall length insulated



G	> Ø < min mm	> Ø < max mm	> Ø < min mm	> Ø < max mm	⌀ mm	ØA mm	H mm	L mm	Art.-Nr. Art. No.	
M16x1.5	6.0	8.0	8.0	10.5	18	28	43	10	1801.11.17	50
M20x1.5	8.0	11.0	11.0	15.0	24	34	46	10	1801.11.20	50
M25x1.5	12.5	16.0	16.0	20.5	30	44	52	11	1801.11.25	25
M32x1.5	17.0	21.0	21.0	25.5	36	50	59	13	1801.11.32	10
M40x1.5	24.0	28.5	28.5	33.0	46	57	59	13	1801.11.40	5

Erhältlich mit Dichteinsatz gemäss EN 45545. Bei Anfragen oder Bestellung bitte ein F vor die Artikelnummer setzen.

Available with sealing inserts conformity with EN 45545. When placing an inquiry, prefix the article number by the capital F.

Kabelverschraubungen Progress® Messing mit Trompete und Klemmbacken

Cable glands Progress® nickel-plated brass with trumpet and clamps

Kurzes Anschlussgewinde Pg | Short entry thread Pg

Material: Messing vernickelt
 Klemmschrauben: Rostfreier Stahl A2
 Dichtung: TPE
 O-Ring: NBR
 Einsatztemperatur: -40°C / +100°C
 Schutzart: IP 68 (bis 10 bar)
 Weitere Schutzart: IP 69

Material: Nickel-plated brass
 Screws: Stainless steel A2
 Seal: TPE
 O-ring: NBR
 Temperature range: -40°C / +100°C
 Protection class: IP 68 (up to 10 bar)
 Further protection: IP 69

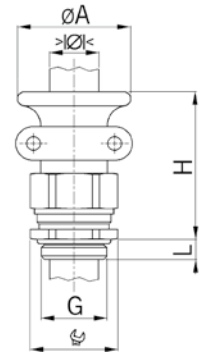

Progress MS T+KB



Zweiteiliger Dichteinsatz
 nicht durchgehend isolierend

Two-piece sealing insert
 not overall length insulated

G	>Øk< min mm	>Øk< max mm	>Øk< min mm	>Øk< max mm	⌀ mm	ØA mm	H mm	L mm	Art.-Nr. Art. No.	
Pg 9	6.0	8.0	8.0	10.5	18	28	43	6	1801.10.09	50
Pg 11	5.5	8.5	8.5	12.0	21	30	43	6	1801.10.11	50
Pg 13	8.0	11.0	11.0	15.0	24	34	46	6	1801.10.13	50
Pg 16	8.0	11.0	11.0	15.0	24	34	46	6	1801.10.16	50
Pg 21	12.5	16.0	16.0	20.5	30	44	52	7.5	1801.10.21	25
Pg 29	19.0	23.0	23.0	27.5	38	50	59	8	1801.10.29	10

Erhältlich mit Dichteinsatz gemäss EN 45545. Bei Anfragen oder Bestellung bitte ein F vor die Artikelnummer setzen.

Available with sealing inserts conformity with EN 45545. When placing an inquiry, prefix the article number by the capital F.



Langes Anschlussgewinde Pg | Long entry thread Pg

Progress MS T+KB



Zweiteiliger Dichteinsatz
 nicht durchgehend isolierend

Two-piece sealing insert
 not overall length insulated

G	>Øk< min mm	>Øk< max mm	>Øk< min mm	>Øk< max mm	⌀ mm	ØA mm	H mm	L mm	Art.-Nr. Art. No.	
Pg 9	6.0	8.0	8.0	10.5	18	28	43	10	1801.11.09	50
Pg 11	5.5	8.5	8.5	12.0	21	30	43	10	1801.11.11	50
Pg 13	8.0	11.0	11.0	15.0	24	34	46	10	1801.11.13	50
Pg 16	8.0	11.0	11.0	15.0	24	34	46	10	1801.11.16	50
Pg 21	12.5	16.0	16.0	20.5	30	44	52	12	1801.11.21	25
Pg 29	19.0	23.0	23.0	27.5	38	50	59	12	1801.11.29	10

Erhältlich mit Dichteinsatz gemäss EN 45545. Bei Anfragen oder Bestellung bitte ein F vor die Artikelnummer setzen.

Available with sealing inserts conformity with EN 45545. When placing an inquiry, prefix the article number by the capital F.



Kabelverschraubungen Progress® aus rostfreiem Stahl

Cable glands Progress® stainless steel

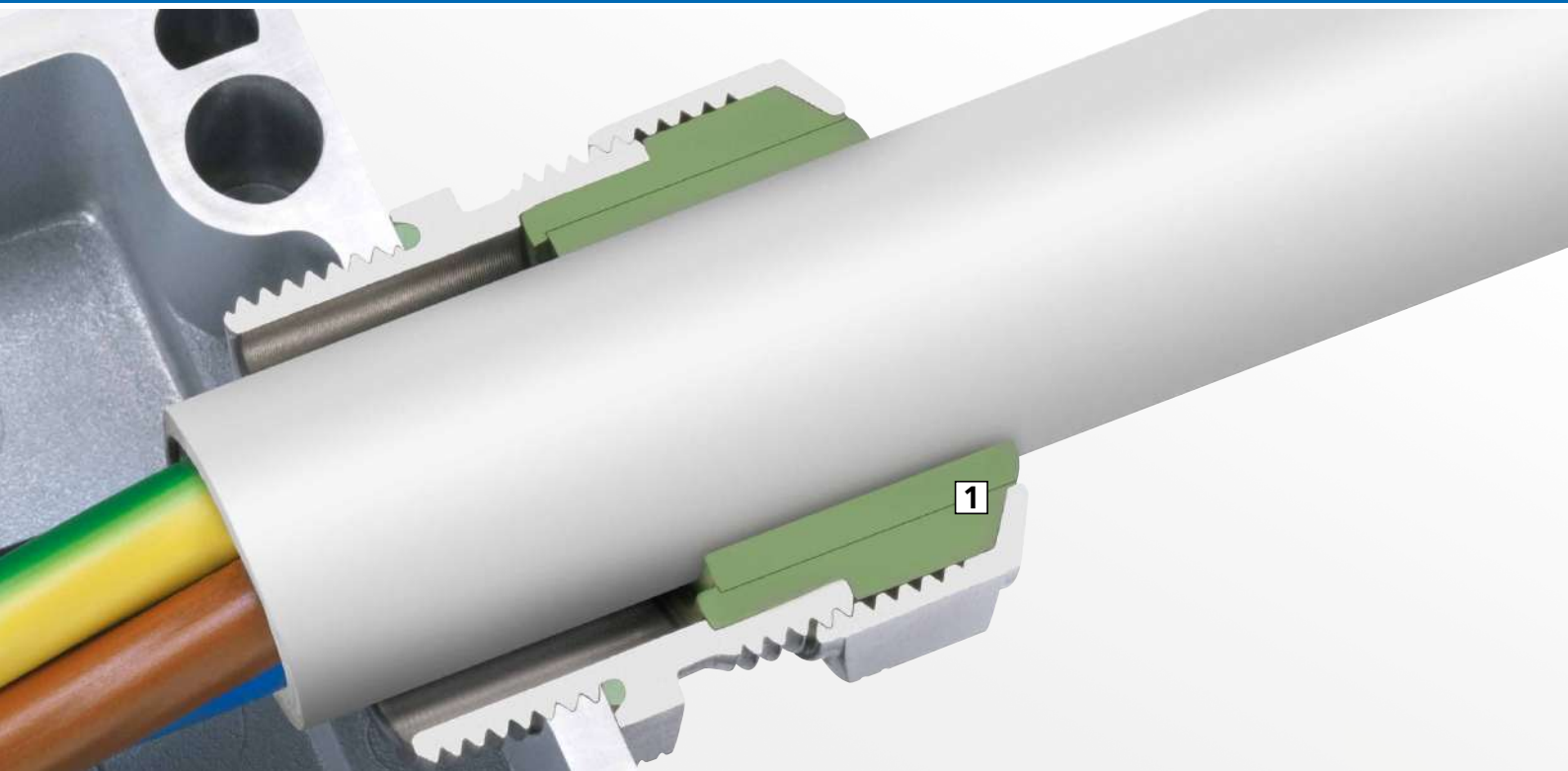

AGRO Kabelverschraubungen Progress® aus rostfreiem Stahl weisen eine hohe Korrosionsbeständigkeit und Langlebigkeit auf. Sie sind prädestiniert für den erschwerten Einsatz in der Lebensmittel sowie chemischen Industrie oder auch an Orten mit besonderen Umweltbedingungen wie z.B. in Tunneln oder auf hoher See. Rostfreie Stähle werden durch die zugeordnete Werkstoffnummer eindeutig spezifiziert. AGRO verwendet für die Kabelverschraubungen den rostfreien Stahl A2 mit der Werkstoffnummer 1.4305 (AISI 303) und für den rostfreien und säurebeständigen Stahl A4 den Werkstoff 1.4435 (AISI 316L).

1 Garantierte Dichtigkeit

Auf den Dichteinsatz abgestimmte Innenkonturen sorgen für eine zielgerichtete Verformung des Dichteinsatzes und garantieren somit dessen perfekte Abdichtung. Die Schutzart IP 68 bis 10 bar sowie IP69 ermöglichen eine breite Anwendung.

AGRO cable glands Progress® made of stainless steel

are highly corrosion-proof and persistent. They are favorable for any application in food or chemical industries or under difficult environmental conditions such as tunnels or in offshore zones. Stainless steels are specified unequivocally by the allocated material number. For the cable glands, AGRO uses the stainless steel A2 with the material number 1.4305 (AISI 303) and for the stainless and acid-resistant steel A4 the material 1.4435 (AISI 316L).

1 Guaranteed seal

Inner contours matched to the sealing insert ensure a targeted deformation of the insert and thus guarantee its tightness in compliance with protection class IP 68 up to 10 bar and IP 69 for a wide range of applications.

Kennzeichnung Stahltyp

Identification marks of steel type



1 Rille kennzeichnet **Stahl A2**. Dichteinsatz in TPE (schwarz)

1 groove identifies steel A2. Sealing insert TPE (black).



1 Rille kennzeichnet **Stahl A2**. Dichteinsatz in FPM für hohe Temperaturen (grün)





1 groove identifies steel A2. Sealing insert FPM for high temperature applications (green).



2 Rillen kennzeichnen **Stahl A4**. Dichteinsatz in FPM für hohe Temperaturen und Säurebeständigkeit (grün)

2 grooves identify steel A4. Sealing insert FPM for high temperature applications and resistant to acids (green).



Kabelverschraubungen Progress® rostfreier Stahl A2 Cable glands Progress® stainless steel A2		60 - 61
Kabelverschraubungen Progress® rostfreier Stahl A2 für hohe Temperaturen Cable glands Progress® stainless steel A2 for high temperature applications		62 - 63
Kabelverschraubungen Progress® rostfreier und säurebeständiger Stahl A4 für hohe Temperaturen Cable glands Progress® stainless and acid-resistant steel A4 for high temperature applications		64 - 65
Kabelverschraubungen Progress® aqua rostfreier Stahl A2 für Trinkwasser Cable glands Progress aqua stainless steel A2 for drinking water		66

Progress® Serie
Progress® series

rostfreier Stahl A2
stainless steel A2

rostfreier Stahl A2
hohe Temperaturen
stainless steel A2
high temperature

rostfreier & säure-
beständiger Stahl A4
hohe Temperaturen
stainless and acid-
resistant steel A4
high temperature

Progress® aqua
rostfreier Stahl A2
für Trinkwasser
Progress aqua
stainless steel A2
for drinking water®

Ausführung / Version	Progress® Serie Progress® series	rostfreier Stahl A2 stainless steel A2	rostfreier Stahl A2 hohe Temperaturen stainless steel A2 high temperature	rostfreier & säure- beständiger Stahl A4 hohe Temperaturen stainless and acid- resistant steel A4 high temperature	Progress® aqua rostfreier Stahl A2 für Trinkwasser Progress aqua stainless steel A2 for drinking water®
Kompressionstechnik / Compression technology		•	•	•	•
Gewinde / Thread					
Anschlussgewinde metrisch Entry thread metric		•	•	•	•
Anschlussgewinde Pg Entry thread Pg		•	•	•	-
Langes Anschlussgewinde Long entry thread		•	•	•	•
Kurzes Anschlussgewinde (Standard) Short entry thread (standard)		A	A	A	A
Dichteinsatz / Sealing insert					
für Rundkabel for round cables		•	•	•	•
für mehrere Kabel (Multi-Dichteinsatz) for multi sealing insert		A	A	A	A
Dichteinsatz ohne Bohrung Sealing insert without drilled hole		A	A	A	-
Einteiliger Dichteinsatz One-piece sealing insert		•	•	•	•
Zweiteiliger Dichteinsatz Two-piece sealing insert		•	•	•	-
Dichteinsatz für EN 45545 Sealing insert for EN 45545		•	-	-	-
Dichteinsatz EPDM (SVGW zertifiziert) Sealing insert EPDM (acc. to SVGW)		-	-	-	•
Technische Besonderheiten / Technical features					
Hohe Säurebeständigkeit Highly acid-resistant		-	-	•	-
Material / Material					
rostfreier Stahl A2 Stainless steel A2		•	•	-	•
rostfreier Stahl A4 Stainless steel A4		-	-	•	-

A = Auf Anfrage / upon request

Kabelverschraubungen Progress® rostfreier Stahl A2

Cable glands Progress® stainless steel A2

Langes Anschlussgewinde metrisch | Long entry thread metric

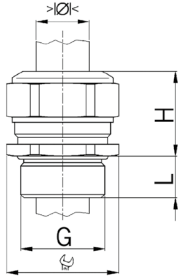

Material: Rostfreier CrNi-Stahl A2 (DIN EN 1.4305 / AISI 303)
 Kennzeichnung: 1 Rille
 Dichtung: TPE
 O-Ring : NBR
 Zugentlastung: Ausführung A nach EN 62444
 Einsatztemperatur: -40°C / +100°C
 Schutzart: IP 68 (bis 10 bar)
 Weitere Schutzart: IP 69

Material: CrNi stainless steel A2 (DIN EN 1.4305 / AISI 303)
 Identification: 1 groove
 Seal: TPE
 O-ring : NBR
 Strain relief: Version A acc. to EN 62444
 Temperature range: -40°C / +100°C
 Protection class: IP 68 (up to 10 bar)
 Further protection: IP 69



Progress S2

Einteiliger Dichteinsatz
 nicht durchgehend isolierend

One-piece sealing insert
 not overall length insulated

G	> Ø < min mm	> Ø < max mm	Ø mm	H mm	L mm	i info	Art.-Nr. Art. No.	
M8x1.25	2.5	3.5	11	14	10	1	1100.08.94.035	50
M8x1.25	3.5	5.0	11	14	10	1	1100.08.94.050	50
M10x1.5	3.0	4.0	13	15	10	1	1100.10.94.040	50
M10x1.5	4.0	6.0	13	15	10	1	1100.10.94.060	50
M12x1.5	3.5	5.0	17	17	10	-	1100.12.94.050	50
M12x1.5	5.0	6.5	17	17	10	-	1100.12.94.065	50
M12x1.5	6.5	8.0	17	17	10	-	1100.12.94.080	50
M16x1.5	8.0	10.5	19	20	10	-	1100.17.94.105	50
M20x1.5	11.0	15.0	24	21	10	-	1100.20.94.150	50
M25x1.5	16.0	20.5	30	25	11	-	1100.25.94.205	25
M32x1.5	21.0	25.5	36	28	13	-	1100.32.94.255	25
M40x1.5	28.5	33.0	46	31	13	-	1100.40.94.330	10
M50x1.5	37.0	42.0	55	34	14	-	1100.50.94.420	10
M63x1.5	46.0	52.0	70	37	14	-	1100.63.94.520	5

1 = Metrisches Regelgewinde (mit VDE Testreport)

1 = Metric coarse-pitch thread (with VDE test report)

Erhältlich mit Dichteinsatz gemäss EN 45545. Bei Anfragen oder Bestellung bitte ein F vor die Artikelnummer setzen.

Available with sealing inserts conformity with EN 45545. When placing an inquiry, prefix the article number by the capital F.



Progress S2

Zweiteiliger Dichteinsatz
 nicht durchgehend isolierend

Two-piece sealing insert
 not overall length insulated

G	> Ø < min mm	> Ø < max mm	> Ø < min mm	> Ø < max mm	Ø mm	H mm	L mm	Art.-Nr. Art. No.	
M16x1.5	6.0	8.0	8.0	10.5	19	20	10	1100.17.94	50
M20x1.5	8.0	11.0	11.0	15.0	24	21	10	1100.20.94	50
M25x1.5	12.5	16.0	16.0	20.5	30	25	11	1100.25.94	25
M32x1.5	17.0	21.0	21.0	25.5	36	28	13	1100.32.94	25
M40x1.5	24.0	28.5	28.5	33.0	46	31	13	1100.40.94	10
M50x1.5	33.0	37.0	37.0	42.0	55	34	14	1100.50.94	10
M63x1.5	40.0	46.0	46.0	52.0	70	37	14	1100.63.94	5

Erhältlich mit Dichteinsatz gemäss EN 45545. Bei Anfragen oder Bestellung bitte ein F vor die Artikelnummer setzen.

Available with sealing inserts conformity with EN 45545. When placing an inquiry, prefix the article number by the capital F.

Kabelverschraubungen Progress® rostfreier Stahl A2

Cable glands Progress® stainless steel A2

Langes Anschlussgewinde Pg | Long entry thread Pg

Material: Rostfreier CrNi-Stahl A2 (DIN EN 1.4305 / AISI 303)
 Kennzeichnung: 1 Rille
 Dichtung: TPE
 O-Ring : NBR
 Einsatztemperatur: -40°C / +100°C
 Schutzart: IP 68 (bis 10 bar)
 Weitere Schutzart: IP 69

Material: CrNi stainless steel A2 (DIN EN 1.4305 / AISI 303)
 Identification: 1 groove
 Seal: TPE
 O-ring : NBR
 Temperature range: -40°C / +100°C
 Protection class: IP 68 (up to 10 bar)
 Further protection: IP 69

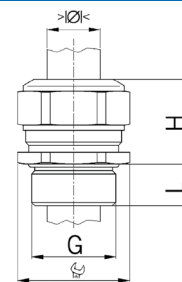

Progress S2



Einteiliger Dichteinsatz
 nicht durchgehend isolierend

One-piece sealing insert
 not overall length insulated

G	>Ø< min mm	>Ø< max mm	Ø mm	H mm	L mm	Art.-Nr. Art. No.	
Pg 7	3.5	5.0	17	17	10	1100.07.94.050	50
Pg 7	5.0	6.5	17	17	10	1100.07.94.065	50
Pg 7	6.5	8.0	17	17	10	1100.07.94.080	50
Pg 9	8.0	10.5	19	20	10	1100.09.94.105	50
Pg 11	8.5	12.0	22	21	10	1100.11.94.120	50
Pg 13	11.0	15.0	24	21	10	1100.13.94.150	50
Pg 16	11.0	15.0	24	21	10	1100.16.94.150	50
Pg 21	16.0	20.5	30	25	12	1100.21.94.205	25
Pg 29	23.0	27.5	41	28	12	1100.29.94.275	25
Pg 36	30.5	35.0	50	32	15	1100.36.94.350	10
Pg 42	37.0	42.0	55	34	15	1100.42.94.420	10
Pg 48	43.0	49.0	65	37	15	1100.48.94.490	10

Erhältlich mit Dichteinsatz gemäss EN 45545. Bei Anfragen oder Bestellung bitte ein F vor die Artikelnummer setzen.

Available with sealing inserts conformity with EN 45545. When placing an inquiry, prefix the article number by the capital F.



Progress S2



Zweiteiliger Dichteinsatz
 nicht durchgehend isolierend

Two-piece sealing insert
 not overall length insulated

G	>Ø< min mm	>Ø< max mm	>Ø< min mm	>Ø< max mm	Ø mm	H mm	L mm	Art.-Nr. Art. No.	
Pg 9	6.0	8.0	8.0	10.5	19	20	10	1100.09.94	50
Pg 11	5.5	8.5	8.5	12.0	21	21	10	1100.11.94	50
Pg 13	8.0	11.0	11.0	15.0	24	21	10	1100.13.94	50
Pg 16	8.0	11.0	11.0	15.0	24	21	10	1100.16.94	50
Pg 21	12.5	16.0	16.0	20.5	30	25	12	1100.21.94	25
Pg 29	19.0	23.0	23.0	27.5	41	28	12	1100.29.94	25
Pg 36	26.0	30.5	30.5	35.0	50	32	15	1100.36.94	10
Pg 42	33.0	37.0	37.0	42.0	55	34	15	1100.42.94	10
Pg 48	37.0	43.0	43.0	49.0	65	37	15	1100.48.94	10

Erhältlich mit Dichteinsatz gemäss EN 45545. Bei Anfragen oder Bestellung bitte ein F vor die Artikelnummer setzen.

Available with sealing inserts conformity with EN 45545. When placing an inquiry, prefix the article number by the capital F.



Kabelverschraubungen Progress® rostfreier Stahl A2 für hohe Temperaturen

Cable glands Progress® stainless steel A2 for high temperature applications

Langes Anschlussgewinde metrisch | Long entry thread metric

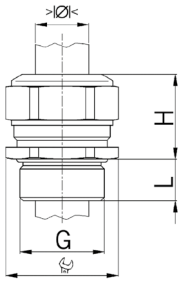

Material: Rostfreier CrNi-Stahl A2 (DIN EN 1.4305 / AISI 303)
 Kennzeichnung: 1 Rille
 Dichtung: FPM
 O-Ring : FPM
 Zugentlastung: Ausführung A nach EN 62444
 Einsatztemperatur: -40°C / +200°C
 Schutzart: IP 68 (bis 10 bar)
 Weitere Schutzart: IP 69

Material: CrNi stainless steel A2 (DIN EN 1.4305 / AISI 303)
 Identification: 1 groove
 Seal: FPM
 O-ring : FPM
 Strain relief: Version A acc. to EN 62444
 Temperature range: -40°C / +200°C
 Protection class: IP 68 (up to 10 bar)
 Further protection: IP 69



Progress S2 HT



Einteiliger Dichteinsatz
 nicht durchgehend isolierend

One-piece sealing insert
 not overall length insulated

G	>Ø< min mm	>Ø< max mm	mm	H mm	L mm	i info	Art.-Nr. Art. No.	
M8x1.25	2.5	3.5	11	14	10	1	1100.08.96.035	50
M8x1.25	3.5	5.0	11	14	10	1	1100.08.96.050	50
M10x1.5	3.0	4.0	13	15	10	1	1100.10.96.040	50
M10x1.5	4.0	6.0	13	15	10	1	1100.10.96.060	50
M12x1.5	3.5	5.0	17	17	10	-	1100.12.96.050	50
M12x1.5	5.0	6.5	17	17	10	-	1100.12.96.065	50
M12x1.5	6.5	8.0	17	17	10	-	1100.12.96.080	50
M16x1.5	8.0	10.5	19	20	10	-	1100.17.96.105	50
M20x1.5	11.0	15.0	24	21	10	-	1100.20.96.150	50
M25x1.5	16.0	20.5	30	25	11	-	1100.25.96.205	25
M32x1.5	21.0	25.5	36	28	13	-	1100.32.96.255	25
M40x1.5	28.5	33.0	46	31	13	-	1100.40.96.330	10
M50x1.5	37.0	42.0	55	34	14	-	1100.50.96.420	10
M63x1.5	46.0	52.0	70	37	14	-	1100.63.96.520	5

1 = Metrisches Regelgewinde (mit VDE Testreport)

1 = Metric coarse-pitch thread (with VDE test report)



Progress S2 HT



Zweiteiliger Dichteinsatz
 nicht durchgehend isolierend

Two-piece sealing insert
 not overall length insulated

G	>Ø< min mm	>Ø< max mm	>Ø< min mm	>Ø< max mm	mm	H mm	L mm	Art.-Nr. Art. No.	
M16x1.5	6.0	8.0	8.0	10.5	19	20	10	1100.17.96	50
M20x1.5	8.0	11.0	11.0	15.0	24	21	10	1100.20.96	50
M25x1.5	12.5	16.0	16.0	20.5	30	25	11	1100.25.96	25
M32x1.5	17.0	21.0	21.0	25.5	36	28	13	1100.32.96	25
M40x1.5	24.0	28.5	28.5	33.0	46	31	13	1100.40.96	10
M50x1.5	33.0	37.0	37.0	42.0	55	34	14	1100.50.96	10
M63x1.5	40.0	46.0	46.0	52.0	70	37	14	1100.63.96	5

Kabelverschraubungen Progress® rostfreier Stahl A2 für hohe Temperaturen

Cable glands Progress® stainless steel A2 for high temperature applications

Langes Anschlussgewinde Pg | Long entry thread Pg

Material: Rostfreier CrNi-Stahl A2
(DIN EN 1.4305 /
AISI 303)

Kennzeichnung: 1 Rille

Dichtung: FPM

O-Ring : FPM

Einsatztemperatur: -40°C / +200°C

Schutzart: IP 68 (bis 10 bar)

Weitere Schutzart: IP 69

Material: CrNi stainless steel A2
(DIN EN 1.4305 /
AISI 303)

Identification: 1 groove

Seal: FPM

O-ring : FPM

Temperature range: -40°C / +200°C

Protection class: IP 68 (up to 10 bar)

Further protection: IP 69

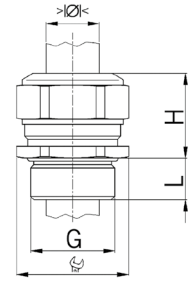

Progress S2 HT



Einteiliger Dichteinsatz
nicht durchgehend isolierend

One-piece sealing insert
not overall length insulated

G	>Ø< min mm	>Ø< max mm	Ø mm	H mm	L mm	Art.-Nr. Art. No.	
Pg 7	3.5	5.0	17	17	10	1100.07.96.050	50
Pg 7	5.0	6.5	17	17	10	1100.07.96.065	50
Pg 7	6.5	8.0	17	17	10	1100.07.96.080	50
Pg 9	8.0	10.5	19	20	10	1100.09.96.105	50
Pg 11	8.5	12.0	22	21	10	1100.11.96.120	50
Pg 13	11.0	15.0	24	21	10	1100.13.96.150	50
Pg 16	11.0	15.0	24	21	10	1100.16.96.150	50
Pg 21	16.0	20.5	30	25	12	1100.21.96.205	25
Pg 29	23.0	27.5	41	28	12	1100.29.96.275	25
Pg 36	30.5	35.0	50	32	15	1100.36.96.350	10
Pg 42	37.0	42.0	55	34	15	1100.42.96.420	10
Pg 48	43.0	49.0	65	37	15	1100.48.96.490	10



Progress S2 HT



Zweiteiliger Dichteinsatz
nicht durchgehend isolierend

Two-piece sealing insert
not overall length insulated

G	>Ø< min mm	>Ø< max mm	>Ø< min mm	>Ø< max mm	Ø mm	H mm	L mm	Art.-Nr. Art. No.	
Pg 9	6.0	8.0	8.0	10.5	19	20	10	1100.09.96	50
Pg 11	5.5	8.5	8.5	12.0	22	21	10	1100.11.96	50
Pg 13	8.0	11.0	11.0	15.0	24	21	10	1100.13.96	50
Pg 16	8.0	11.0	11.0	15.0	24	21	10	1100.16.96	50
Pg 21	12.5	16.0	16.0	20.5	30	25	12	1100.21.96	25
Pg 29	19.0	23.0	23.0	27.5	41	28	12	1100.29.96	25
Pg 36	26.0	30.5	30.5	35.0	50	32	15	1100.36.96	10
Pg 42	33.0	37.0	37.0	42.0	55	34	15	1100.42.96	10
Pg 48	37.0	43.0	43.0	49.0	65	37	15	1100.48.96	10



Kabelverschraubungen Progress® rostfreier und säurebeständiger Stahl A4 für hohe Temperaturen

Cable glands Progress® stainless and acid-resistant steel A4 for high temperature applications

Langes Anschlussgewinde metrisch | Long entry thread metric

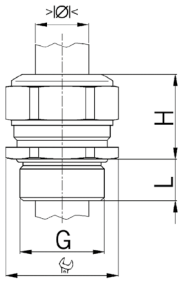

Material: Rostfreier und säurebeständiger CrNiMo-Stahl A4 (DIN EN 1.4435 / AISI 316L)

Kennzeichnung: 2 Rillen

Dichtung: FPM

O-Ring : FPM

Zugentlastung: Ausführung A nach EN 62444

Einsatztemperatur: -40°C / +200°C

Schutzart: IP 68 (bis 10 bar)

Weitere Schutzart: IP 69

Material: Stainless and acid resistant steel A4 CrNiMo (DIN EN 1.4435 / AISI 316L)

Identification: 2 grooves

Seal: FPM

O-ring : FPM

Strain relief: Version A acc. to EN 62444

Temperature range: -40°C / +200°C

Protection class: IP 68 (up to 10 bar)

Further protection: IP 69



Progress S4 HT



Einteiliger Dichteinsatz
nicht durchgehend isolierend

One-piece sealing insert
not overall length insulated

G	>Ø< min mm	>Ø< max mm	Ø mm	H mm	L mm	i info	Art.-Nr. Art. No.	
M8x1.25	2.5	3.5	11	14	10	1	1100.08.98.035	50
M8x1.25	3.5	5.0	11	14	10	1	1100.08.98.050	50
M10x1.5	3.0	4.0	13	15	10	1	1100.10.98.040	50
M10x1.5	4.0	6.0	13	15	10	1	1100.10.98.060	50
M12x1.5	3.5	5.0	17	17	10	-	1100.12.98.050	50
M12x1.5	5.0	6.5	17	17	10	-	1100.12.98.065	50
M12x1.5	6.5	8.0	17	17	10	-	1100.12.98.080	50
M16x1.5	8.0	10.5	19	20	10	-	1100.17.98.105	50
M20x1.5	11.0	15.0	24	21	10	-	1100.20.98.150	50
M25x1.5	16.0	20.5	30	25	11	-	1100.25.98.205	25
M32x1.5	21.0	25.5	36	28	13	-	1100.32.98.255	25
M40x1.5	28.5	33.0	46	31	13	-	1100.40.98.330	10
M50x1.5	37.0	42.0	55	34	14	-	1100.50.98.420	10
M63x1.5	46.0	52.0	70	37	14	-	1100.63.98.520	5

1 = Metrisches Regelgewinde (mit VDE Testreport)

1 = Metric coarse-pitch thread (with VDE test report)



Progress S4 HT



Zweiteiliger Dichteinsatz
nicht durchgehend isolierend

Two-piece sealing insert
not overall length insulated

G	>Ø< min mm	>Ø< max mm	>Ø< min mm	>Ø< max mm	Ø mm	H mm	L mm	Art.-Nr. Art. No.	
M16x1.5	6.0	8.0	8.0	10.5	19	20	10	1100.17.98	50
M20x1.5	8.0	11.0	11.0	15.0	24	21	10	1100.20.98	50
M25x1.5	12.5	16.0	16.0	20.5	30	25	11	1100.25.98	25
M32x1.5	17.0	21.0	21.0	25.5	36	28	13	1100.32.98	25
M40x1.5	24.0	28.5	28.5	33.0	46	31	13	1100.40.98	10
M50x1.5	33.0	37.0	37.0	42.0	55	34	14	1100.50.98	10
M63x1.5	40.0	46.0	46.0	52.0	70	37	14	1100.63.98	5

Kabelverschraubungen Progress® rostfreier und säurebeständiger Stahl A4 für hohe Temperaturen

Cable glands Progress® stainless and acid-resistant steel A4 for high temperature applications

Langes Anschlussgewinde Pg | Long entry thread Pg

Material: Rostfreier und säurebeständiger CrNiMo-Stahl A4 (DIN EN 1.4435 / AISI 316L)
 Kennzeichnung: 2 Rillen
 Dichtung: FPM
 O-Ring : FPM
 Einsatztemperatur: -40°C / +200°C
 Schutzart: IP 68 (bis 10 bar)
 Weitere Schutzart: IP 69

Material: Stainless and acid resistant steel A4 CrNiMo (DIN EN 1.4435 / AISI 316L)
 Identification: 2 grooves
 Seal: FPM
 O-ring : FPM
 Temperature range: -40°C / +200°C
 Protection class: IP 68 (up to 10 bar)
 Further protection: IP 69

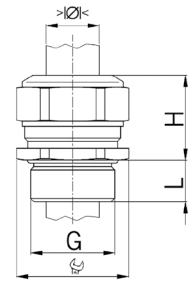

Progress S4 HT



Einteiliger Dichteinsatz
 nicht durchgehend isolierend

One-piece sealing insert
 not overall length insulated

G	>Ø< min mm	>Ø< max mm	Ø _{bar} mm	H mm	L mm	Art.-Nr. Art. No.	
Pg 7	3.5	5.0	17	17	10	1100.07.98.050	50
Pg 7	5.0	6.5	17	17	10	1100.07.98.065	50
Pg 7	6.5	8.0	17	17	10	1100.07.98.080	50
Pg 9	8.0	10.5	19	20	10	1100.09.98.105	50
Pg 11	8.5	12.0	22	21	10	1100.11.98.120	50
Pg 13	11.0	15.0	24	21	10	1100.13.98.150	50
Pg 16	11.0	15.0	24	21	10	1100.16.98.150	50
Pg 21	16.0	20.5	30	25	12	1100.21.98.205	25
Pg 29	23.0	27.5	41	28	12	1100.29.98.275	25
Pg 36	30.5	35.0	50	32	15	1100.36.98.350	10
Pg 42	37.0	42.0	55	34	15	1100.42.98.420	10
Pg 48	43.0	49.0	65	37	15	1100.48.98.490	10



Progress S4 HT



Zweiteiliger Dichteinsatz
 nicht durchgehend isolierend

Two-piece sealing insert
 not overall length insulated

G	>Ø< min mm	>Ø< max mm	>Ø< min mm	>Ø< max mm	Ø _{bar} mm	H mm	L mm	Art.-Nr. Art. No.	
Pg 9	6.0	8.0	8.0	10.5	19	20	10	1100.09.98	50
Pg 11	5.5	8.5	8.5	12.0	22	21	10	1100.11.98	50
Pg 13	8.0	11.0	11.0	15.0	24	21	10	1100.13.98	50
Pg 16	8.0	11.0	11.0	15.0	24	21	10	1100.16.98	50
Pg 21	12.5	16.0	16.0	20.5	30	25	12	1100.21.98	25
Pg 29	19.0	23.0	23.0	27.5	41	28	12	1100.29.98	25
Pg 36	26.0	30.5	30.5	35.0	50	32	15	1100.36.98	10
Pg 42	33.0	37.0	37.0	42.0	55	34	15	1100.42.98	10
Pg 48	37.0	43.0	43.0	49.0	65	37	15	1100.48.98	10



Kabelverschraubungen Progress® aqua rostfreier Stahl A2 für Trinkwasser

Cable glands Progress® aqua stainless steel A2 for drinking water

Langes Anschlussgewinde metrisch | Long entry thread metric

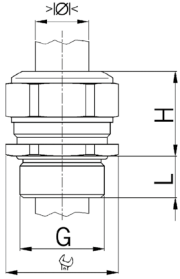

Material: Rostfreier CrNi-Stahl A2 (DIN EN 1.4305 / AISI 303)
 Kennzeichnung: Progress® aqua
 Dichtung: EPDM
 O-Ring : EPDM
 Einsatztemperatur: -40°C / +80°C
 Schutzart: IP 68 (bis 5 bar)
 Zertifikat: SVGW (1603-H6481)
 Materialprüfung: KTW W270

Material: CrNi stainless steel A2 (DIN EN 1.4305 / AISI 303)
 Identification: Progress® aqua
 Seal: EPDM
 O-ring : EPDM
 Temperature range: -40°C / +80°C
 Protection class: IP 68 (up to 5 bar)
 Certificate: SVGW (1603-H6481)
 Material testing: KTW W270



Progress® aqua



Einteiliger Dichteinsatz
 nicht durchgehend isolierend

One-piece sealing insert
 not overall length insulated

G	>Ø< min mm	>Ø< max mm	mm	H mm	L mm	Art.-Nr. Art. No.	
M12x1.5	2.0	5.0	17	17	10	W1100.12.95.050	50
M12x1.5	3.0	6.5	17	17	10	W1100.12.95.065	50
M12x1.5	5.0	8.0	17	17	10	W1100.12.95.080	50
M16x1.5	7.0	10.5	19	20	10	W1100.17.95.105	50
M20x1.5	11.0	15.0	24	21	10	W1100.20.95.150	50
M25x1.5	16.0	20.5	30	25	11	W1100.25.95.205	25
M32x1.5	21.0	25.5	36	28	13	W1100.32.95.255	25
M40x1.5	28.0	33.0	46	31	13	W1100.40.95.330	10

Weitere Ausführungen und Anschlussgewinde auf Anfrage Further versions and entry threads are available upon request.



<p>Kabelverschraubungen Progress® ultraFLAT Cable glands Progress® ultraFLAT</p>		<p>69 - 70</p>	<p>1</p>
<p>Kabelverschraubungen Progress® Messing Winkel 90° Cable glands Progress® nickel-plated brass elbow 90°</p>		<p>71 - 74</p>	<p>2</p>
<p>Winkel 90° und 45° Messing mit Innen- und Aussengewinde Elbow 90° and 45° nickel-plated brass with internal and external thread</p>		<p>75</p>	<p>3</p>
<p>Flanschwinkel 90° Zinkdruckguss Flanged elbow 90° zinc diecasting</p>		<p>76</p>	<p>4</p>
<p>Universal Kabeleinführung für Flach- und Rundkabel Universal cable entry for flat and round cables</p>		<p>77</p>	<p>5</p>
<p>Stopfbuchsen Messing nach DIN 46320-C4-MS Cable glands nickel-plated brass according to DIN 46320-C4-MS</p>		<p>78 - 79</p>	<p>6</p>
<p>Stopfbuchsen Messing mit Klemmbacken Cable glands nickel-plated brass with clamps</p>		<p>80</p>	<p>7</p>
<p>Stopfbuchsen Messing mit Trompete und Klemmbacken Cable glands nickel-plated brass with trumpet and clamps</p>		<p>81</p>	<p>8</p>
<p>Stopfbuchsen Messing mit Schutztülle und Klemmbacken Cable glands nickel-plated brass with antikink nozzle and clamps</p>		<p>82 - 83</p>	<p>9</p>
			<p>10</p>
			<p>11</p>
			<p>12</p>

Spezielle Kabelverschraubungen und -einführungen aus Messing Special cable glands and cable entries nickel-plated brass



Die **Progress® ultraFLAT** ist eine Kabelverschraubung für vier Anwendungsgebiete – den Reinraum, die Lebensmittelindustrie, den Antivandalismus und das Design. Die ultraflache Konstruktion der Kabelverschraubung **Progress® ultraFLAT** verhindert eine Manipulation von aussen. Sie bietet keine Angriffsfläche für eine Beeinträchtigung von Hand oder auch mit Werkzeugen. Ausserdem überzeugt die Kabelverschraubung durch ihre schlichte und überaus ansprechende Formgebung für den Einsatz in Design-Applikationen.

Die Kabelverschraubung **Progress® ultraFLAT** bietet wenig Oberfläche, an der sich Verschmutzungen ablagern können – die gute Reinigbarkeit für den Einsatz in Reinräumen oder der Lebensmittelindustrie wird durch die Zertifizierung bei der European Hygienic Engineering & Design Group (EHEDG) bestätigt. Ausführungen in Edelstahl und Dichteinsätze für Hochtemperaturen oder mit FDA Konformität sprechen für diese Wahl.

Sind bei der Kabelinstallation enge Raumverhältnisse gegeben, kann der Anwender auf die Vorteile von **Winkeln und Flanschwinkeln** bauen.

Hier werden Leitungen um die Ecke geführt und je nach der verwendeten Kabelverschraubung zu 100% vor der Knickstelle zugentlastet. Zur Auswahl stehen neben 90°-Winkeln auch 45°-Winkel für eine leichte Biegung des Kabels.

The **Progress® ultraFLAT** is a cable gland for four application areas: Clean rooms, food industry, anti vandalism and design. The ultra flat construction of the **Progress® ultraFLAT** cable gland prevents any manipulation from the outside. No contact surface for interference neither by hand or with a tool will be found. In addition, the cable gland convinces with an attractive shape and invites to be used for design applications.

The **Progress® ultraFLAT** cable gland offers very little surface for contamination – the good cleanability which is crucial for cleanroom and food applications is documented by a certificate of the EHEDG. Executions in steel and with high-temperature or FDA cleared sealing inserts are further arguments for this choice.

If space is at a premium the user can take advantage of the benefits of **elbows and flanged elbows** for cable installations.

The cables are run around the bend and, depending upon the type of cable gland used, completely relieved of any strain before the kinking point. Apart from 90° elbows, 45° elbows are also available to reduce the bend on the cable.

EHEDG Zertifizierung

Die **European Hygienic Engineering & Design Group** (EHEDG) ist eine Expertengemeinschaft von Maschinen- und Komponenten-Herstellern, Fachleuten aus der Nahrungsmittelindustrie sowie von Forschungsinstituten und Gesundheitsbehörden. Die Organisation wurde 1989 in der Absicht gegründet, das Bewusstsein für Hygiene bei der Verarbeitung und Verpackung von Nahrungsmitteln zu stärken.

Die Hauptaufgabe der EHEDG ist es, zur hygienegerechten Konstruktion und Gestaltung in allen Bereichen der Nahrungsmittelproduktion beizutragen und damit eine sichere Herstellung von Lebensmitteln zu gewährleisten.



EHEDG Certification

The **European Hygienic Engineering & Design Group** (EHEDG) is a consortium of equipment manufacturers, food industries, research institutes as well as public health authorities and was founded in 1989 with the aim to promote hygiene during the processing and packing of food products.

The principal goal of EHEDG is the promotion of safe food by improving hygienic engineering and design in all aspects of food manufacture.

Kabelverschraubungen Progress® ultraFLAT Messing

Cable glands Progress® ultraFLAT nickel-plated brass

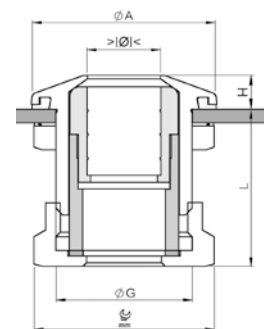

Anschlussgewinde metrisch | Entry thread metric

Frontring:	Messing halbglanz vernickelt	Front part:	semi-bright nickel-plated brass
Druckmutter:	Messing vernickelt	Push-down nut:	Nickel-plated brass
Dichtung:	TPE	Seal:	TPE
Dichtscheibe:	FPM	Sealing washer:	FPM
Zugentlastung:	Ausführung A nach EN 62444	Strain relief:	Version A acc. to EN 62444
Einsatztemperatur:	-40°C / +100°C	Temperature range:	-40°C / +100°C
Schutzart:	IP 68 (bis 10 bar)	Protection class:	IP 68 (up to 10 bar)
Weitere Schutzart:	IP 69	Further protection:	IP 69
Wandstärke:	max. 5 mm	Wall thickness:	max. 5 mm



Einteiliger Dichteinsatz
nicht durchgehend isolierend

One-piece sealing insert
not overall length insulated

G	> < < min mm	> < < max mm	 mm	ϕA mm	H mm	L mm	Art.-Nr. Art. No.	
M16x1.5	5.0	6.5	19	22	4.0	21	1040.17.40.065	25
M16x1.5	6.5	8.0	19	22	4.0	21	1040.17.40.080	25
M20x1.5	6.0	8.0	24	27	4.5	23	1040.20.40.080	25
M20x1.5	8.0	10.5	24	27	4.5	23	1040.20.40.105	25
M25x1.5	8.0	11.0	30	32	5.5	25	1040.25.40.110	20
M25x1.5	11.0	15.0	30	32	5.5	25	1040.25.40.150	20
M32x1.5	12.5	16.0	36	39	6.0	28	1040.32.40.160	10
M32x1.5	16.0	20.5	36	39	6.0	28	1040.32.40.205	10

Auf Anfrage lieferbar:

Available on request:

Rostfreier und säurebeständiger Stahl A4

Stainless and acid resistant steel A4



Kabelverschraubungen Progress® ultraFLAT rostfreier Stahl A2

Cable glands Progress® ultraFLAT stainless steel A2

Anschlussgewinde metrisch | Entry thread metric

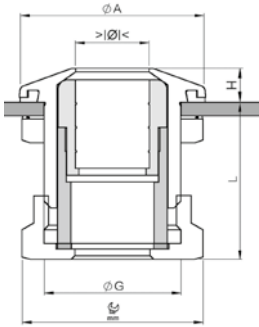

Fronting:	Rostfreier CrNi-Stahl A2 (DIN EN 1.4305 / AISI 303)	Front part:	CrNi stainless steel A2 (DIN EN 1.4305 / AISI 303)
Druckmutter:	Messing vernickelt	Push-down nut:	Nickel-plated brass
Dichtung:	FKM	Seal:	FKM
Dichtscheibe:	FKM	Sealing washer:	FKM
Zugentlastung:	Ausführung A nach EN 62444	Strain relief:	Version A acc. to EN 62444
Einsatztemperatur:	-40°C / +200°C	Temperature range:	-40°C / +200°C
Schutzart:	IP 68 (bis 10 bar)	Protection class:	IP 68 (up to 10 bar)
Weitere Schutzart:	IP 69	Further protection:	IP 69
Wandstärke:	max. 5 mm	Wall thickness:	max. 5 mm
Zertifikat:	EHEDG	Certificate:	EHEDG



Einteiliger Dichteinsatz nicht durchgehend isolierend		One-piece sealing insert not overall length insulated							
G	> \varnothing <	> \varnothing <	$\varnothing A$	H	L	i	Art.-Nr. Art. No.		
	min mm	max mm	mm	mm	mm	info			
M16x1.5	5.0	6.5	19	22	4.0	21	1	1040.17.96.30.065	25
M16x1.5	6.5	8.0	19	22	4.0	21	1	1040.17.96.30.080	25
M20x1.5	6.0	8.0	24	27	4.5	23	1	1040.20.96.30.080	25
M20x1.5	8.0	10.5	24	27	4.5	23	1	1040.20.96.30.105	25
M25x1.5	8.0	11.0	30	32	5.5	25	1	1040.25.96.30.110	20
M25x1.5	11.0	15.0	30	32	5.5	25	1	1040.25.96.30.150	20
M32x1.5	12.5	16.0	36	39	6.0	28	1	1040.32.96.30.160	10
M32x1.5	16.0	20.5	36	39	6.0	28	1	1040.32.96.30.205	10

1 = Lieferbar auf Anfrage 1 = Available on request
 FDA konforme Dichtungen FDA-cleared sealings



Anschlussgewinde metrisch | Entry thread metric

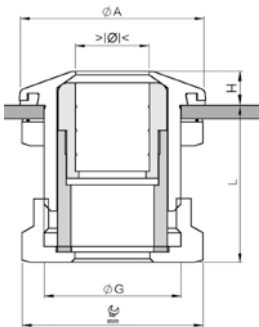

Fronting:	Rostfreier CrNi-Stahl A2 (DIN EN 1.4305 / AISI 303)	Front part:	CrNi stainless steel A2 (DIN EN 1.4305 / AISI 303)
Druckmutter:	Messing vernickelt	Push-down nut:	Nickel-plated brass
Dichtung:	FPM	Seal:	FPM
Dichtscheibe:	FPM	Sealing washer:	FPM
Zugentlastung:	Ausführung A nach EN 62444	Strain relief:	Version A acc. to EN 62444
Einsatztemperatur:	-40°C / +200°C	Temperature range:	-40°C / +200°C
Schutzart:	IP 68 (bis 10 bar)	Protection class:	IP 68 (up to 10 bar)
Weitere Schutzart:	IP 69	Further protection:	IP 69
Wandstärke:	max. 5 mm	Wall thickness:	max. 5 mm



Einteiliger Dichteinsatz nicht durchgehend isolierend		One-piece sealing insert not overall length insulated							
G	> \varnothing <	> \varnothing <	$\varnothing A$	H	L	i	Art.-Nr. Art. No.		
	min mm	max mm	mm	mm	mm	info			
M16x1.5	5.0	6.5	19	22	4.0	21	-	1040.17.96.70.065	25
M16x1.5	6.5	8.0	19	22	4.0	21	-	1040.17.96.70.080	25
M20x1.5	6.0	8.0	24	27	4.5	23	1	1040.20.96.70.080	25
M20x1.5	8.0	10.5	24	27	4.5	23	-	1040.20.96.70.105	25
M25x1.5	8.0	11.0	30	32	5.5	25	1	1040.25.96.70.110	20
M25x1.5	11.0	15.0	30	32	5.5	25	-	1040.25.96.70.150	20
M32x1.5	12.5	16.0	36	39	6.0	28	1	1040.32.96.70.160	10
M32x1.5	16.0	20.5	36	39	6.0	28	-	1040.32.96.70.205	10

1 = Lieferbar auf Anfrage 1 = Available on request



Kabelverschraubungen Progress® Messing Winkel 90°

Cable glands Progress® nickel-plated brass elbow 90°

Kurzes Anschlussgewinde metrisch | Short entry thread metric

Material: Messing vernickelt
 Dichtung: TPE
 Zugentlastung: Ausführung A nach EN 62444
 Einsatztemperatur: -40°C / +100°C
 Schutzart: IP 68
 Gewinde: IP 68, wenn Anschlussgewinde abgedichtet

Material: Nickel-plated brass
 Seal: TPE
 Strain relief: Version A acc. to EN 62444
 Temperature range: -40°C / +100°C
 Protection class: IP 68
 Entry thread: IP 68, if the entry thread is sealed

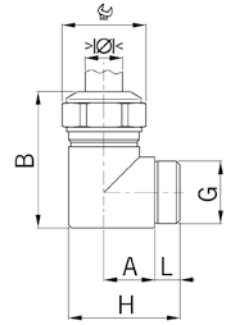

Progress MS W90



Einteiliger Dichteinsatz
 nicht durchgehend isolierend

One-piece sealing insert
 not overall length insulated

G	>Ø< min mm	>Ø< max mm	Ø mm	H mm	L mm	A mm	B mm	Art.-Nr. Art. No.	
M12x1.5	5.0	6.5	15	27	8	11	32	5200.12	50

Erhältlich mit Dichteinsatz gemäss EN 45545. Bei Anfragen oder Bestellung bitte ein F vor die Artikelnummer setzen.

Available with sealing inserts conformity with EN 45545. When placing an inquiry, prefix the article number by the capital F.



Progress MS W90



Zweiteiliger Dichteinsatz
 nicht durchgehend isolierend

Two-piece sealing insert
 not overall length insulated

G	>Ø< min mm	>Ø< max mm	>Ø< min mm	>Ø< max mm	Ø mm	H mm	L mm	A mm	B mm	Art.-Nr. Art. No.	
M16x1.5	6.0	8.0	8.0	10.5	18	30	8	13	36	5200.17	50
M20x1.5	8.0	11.0	11.0	15.0	24	35	8	16	44	5200.20	50
M25x1.5	12.5	16.0	16.0	20.5	30	44	10	20	52	5200.25	25
M32x1.5	17.0	21.0	21.0	25.5	36	50	10	23	60	5200.32	25
M40x1.5	24.0	28.5	28.5	33.0	46	60	10	28	72	5200.40	10

Erhältlich mit Dichteinsatz gemäss EN 45545. Bei Anfragen oder Bestellung bitte ein F vor die Artikelnummer setzen.

Available with sealing inserts conformity with EN 45545. When placing an inquiry, prefix the article number by the capital F.



Langes Anschlussgewinde metrisch | Long entry thread metric

Progress MS W90



Einteiliger Dichteinsatz
 nicht durchgehend isolierend

One-piece sealing insert
 not overall length insulated

G	>Ø< min mm	>Ø< max mm	Ø mm	H mm	L mm	A mm	B mm	Art.-Nr. Art. No.	
M12x1.5	5.0	6.5	15	30	12	11	32	5210.12	50

Erhältlich mit Dichteinsatz gemäss EN 45545. Bei Anfragen oder Bestellung bitte ein F vor die Artikelnummer setzen.

Available with sealing inserts conformity with EN 45545. When placing an inquiry, prefix the article number by the capital F.



Progress MS W90



Zweiteiliger Dichteinsatz
 nicht durchgehend isolierend

Two-piece sealing insert
 not overall length insulated

G	>Ø< min mm	>Ø< max mm	>Ø< min mm	>Ø< max mm	Ø mm	H mm	L mm	A mm	B mm	Art.-Nr. Art. No.	
M16x1.5	6.0	8.0	8.0	10.5	18	34	12	13	36	5210.17	50
M20x1.5	8.0	11.0	11.0	15.0	24	39	12	16	44	5210.20	50
M25x1.5	12.5	16.0	16.0	20.5	30	48	14	20	52	5210.25	25
M32x1.5	17.0	21.0	21.0	25.5	36	56	16	23	60	5210.32	25
M40x1.5	24.0	28.5	28.5	33.0	46	66	16	28	72	5210.40	10

Erhältlich mit Dichteinsatz gemäss EN 45545. Bei Anfragen oder Bestellung bitte ein F vor die Artikelnummer setzen.

Available with sealing inserts conformity with EN 45545. When placing an inquiry, prefix the article number by the capital F.



Kabelverschraubungen Progress® Messing Winkel 90°

Cable glands Progress® nickel-plated brass elbow 90°

Kurzes Anschlussgewinde Pg | Short entry thread Pg

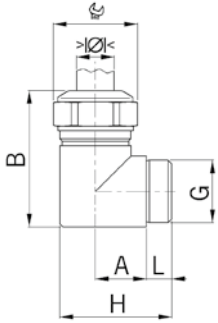

Material: Messing vernickelt
 Dichtung: TPE
 Einsatztemperatur: -40°C / +100°C
 Schutzart: IP 68
 Gewinde: IP 68, wenn Anschlussgewinde abgedichtet

Material: Nickel-plated brass
 Seal: TPE
 Temperature range: -40°C / +100°C
 Protection class: IP 68
 Entry thread: IP 68, if the entry thread is sealed



Progress MS W90

Einteiliger Dichteinsatz
 nicht durchgehend isolierend

One-piece sealing insert
 not overall length insulated

G	> Ø <	> Ø <	⌀	H	L	A	B	Art.-Nr. Art. No.	
	min mm	max mm	mm	mm	mm	mm	mm		
Pg 7	5.0	6.5	15	27	8	11	32	5200.07	50

Erhältlich mit Dichteinsatz gemäss EN 45545. Bei Anfragen oder Bestellung bitte ein F vor die Artikelnummer setzen.

Available with sealing inserts conformity with EN 45545. When placing an inquiry, prefix the article number by the capital F.



Progress MS W90

Zweiteiliger Dichteinsatz
 nicht durchgehend isolierend

Two-piece sealing insert
 not overall length insulated

G	> Ø <	> Ø <	> Ø <	> Ø <	⌀	H	L	A	B	Art.-Nr. Art. No.	
	min mm	max mm	min mm	max mm	mm	mm	mm	mm	mm		
Pg 9	6.0	8.0	8.0	10.5	18	30	8	13	36	5200.09	50
Pg 11	5.5	8.5	8.5	12.0	21	35	8	14	40	5200.11	50
Pg 13	8.0	11.0	11.0	15.0	24	41	10	16	44	5200.13	50
Pg 16	8.0	11.0	11.0	15.0	24	41	10	16	44	5200.16	50
Pg 21	12.5	16.0	16.0	20.5	30	44	10	20	52	5200.21	25
Pg 29	19.0	23.0	23.0	27.5	38	56	10	24	65	5200.29	10

Erhältlich mit Dichteinsatz gemäss EN 45545. Bei Anfragen oder Bestellung bitte ein F vor die Artikelnummer setzen.

Available with sealing inserts conformity with EN 45545. When placing an inquiry, prefix the article number by the capital F.

Langes Anschlussgewinde Pg | Long entry thread Pg



Progress MS W90

Einteiliger Dichteinsatz
 nicht durchgehend isolierend

One-piece sealing insert
 not overall length insulated

G	> Ø <	> Ø <	⌀	H	L	A	B	Art.-Nr. Art. No.	
	min mm	max mm	mm	mm	mm	mm	mm		
Pg 7	5.0	6.5	15	30	11	11	32	5210.07	50

Erhältlich mit Dichteinsatz gemäss EN 45545. Bei Anfragen oder Bestellung bitte ein F vor die Artikelnummer setzen.

Available with sealing inserts conformity with EN 45545. When placing an inquiry, prefix the article number by the capital F.



Progress MS W90

Zweiteiliger Dichteinsatz
 nicht durchgehend isolierend

Two-piece sealing insert
 not overall length insulated

G	> Ø <	> Ø <	> Ø <	> Ø <	⌀	H	L	A	B	Art.-Nr. Art. No.	
	min mm	max mm	min mm	max mm	mm	mm	mm	mm	mm		
Pg 9	6.0	8.0	8.0	10.5	18	34	11	13	36	5210.09	50
Pg 11	5.5	8.5	8.5	12.0	21	38	11	14	40	5210.11	50
Pg 13	8.0	11.0	11.0	15.0	24	44	13	16	44	5210.13	50
Pg 16	8.0	11.0	11.0	15.0	24	44	13	16	44	5210.16	50
Pg 21	12.5	16.0	16.0	20.5	30	48	14	20	52	5210.21	25
Pg 29	19.0	23.0	23.0	27.5	38	60	14	24	65	5210.29	10

Erhältlich mit Dichteinsatz gemäss EN 45545. Bei Anfragen oder Bestellung bitte ein F vor die Artikelnummer setzen.

Available with sealing inserts conformity with EN 45545. When placing an inquiry, prefix the article number by the capital F.

Kabelverschraubungen Progress® Messing Winkel 90°

Cable glands Progress® nickel-plated brass elbow 90°

Langes Anschlussgewinde metrisch mit Gegenmutter | Long entry thread metric with lock nut

Material: Messing vernickelt
 Dichtung: TPE
 O-Ring: NBR
 Zugentlastung: Ausführung A nach EN 62444
 Einsatztemperatur: -40°C / +100°C
 Schutzart: IP 68

Material: Nickel-plated brass
 Seal: TPE
 O-ring: NBR
 Strain relief: Version A acc. to EN 62444
 Temperature range: -40°C / +100°C
 Protection class: IP 68

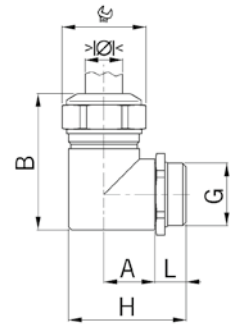

Progress MS W90



Einteiliger Dichteinsatz
 nicht durchgehend isolierend

One-piece sealing insert
 not overall length insulated

G	> Ø <	> Ø <	∅	H	L	A	B	Art.-Nr. Art. No.	
	min mm	max mm	mm	mm	mm	mm	mm		
M12x1.5	5.0	6.5	15	30	12	11	32	5215.12	50

Erhältlich mit Dichteinsatz gemäss EN 45545. Bei Anfragen oder Bestellung bitte ein F vor die Artikelnummer setzen.

Available with sealing inserts conformity with EN 45545. When placing an inquiry, prefix the article number by the capital F.



Progress MS W90



Zweiteiliger Dichteinsatz
 nicht durchgehend isolierend

Two-piece sealing insert
 not overall length insulated

G	> Ø <	> Ø <	> Ø <	> Ø <	∅	H	L	A	B	Art.-Nr. Art. No.	
	min mm	max mm	min mm	max mm	mm	mm	mm	mm	mm		
M16x1.5	6.0	8.0	8.0	10.5	18	34	12	13	36	5215.17	50
M20x1.5	8.0	11.0	11.0	15.0	24	39	12	16	44	5215.20	50
M25x1.5	12.5	16.0	16.0	20.5	30	48	14	20	52	5215.25	25
M32x1.5	17.0	21.0	21.0	25.5	36	56	16	23	60	5215.32	25
M40x1.5	24.0	28.5	28.5	33.0	46	66	16	28	72	5215.40	10

Erhältlich mit Dichteinsatz gemäss EN 45545. Bei Anfragen oder Bestellung bitte ein F vor die Artikelnummer setzen.

Available with sealing inserts conformity with EN 45545. When placing an inquiry, prefix the article number by the capital F.



Kabelverschraubungen Progress® Messing Winkel 90°

Cable glands Progress® nickel-plated brass elbow 90°

Langes Anschlussgewinde Pg mit Gegenmutter | Long entry thread Pg with lock nut

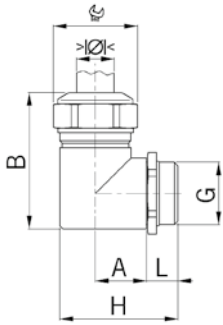

Material: Messing vernickelt
 Dichtung: TPE
 O-Ring: NBR
 Einsatztemperatur: -40°C / +100°C
 Schutzart: IP 68

Material: Nickel-plated brass
 Seal: TPE
 O-ring: NBR
 Temperature range: -40°C / +100°C
 Protection class: IP 68



Progress MS W90



Einteiliger Dichteinsatz
 nicht durchgehend isolierend

One-piece sealing insert
 not overall length insulated

G	> Ø < min mm	> Ø < max mm	⌀ mm	H mm	L mm	A mm	B mm	Art.-Nr. Art. No.	
Pg 7	5.0	6.5	15	30	11	11	32	5215.07	50

Erhältlich mit Dichteinsatz gemäss EN 45545. Bei Anfragen oder Bestellung bitte ein F vor die Artikelnummer setzen.

Available with sealing inserts conformity with EN 45545. When placing an inquiry, prefix the article number by the capital F.



Progress MS W90



Zweiteiliger Dichteinsatz
 nicht durchgehend isolierend

Two-piece sealing insert
 not overall length insulated

G	> Ø < min mm	> Ø < max mm	> Ø < min mm	> Ø < max mm	⌀ mm	H mm	L mm	A mm	B mm	Art.-Nr. Art. No.	
Pg 9	6.0	8.0	8.0	10.5	18	34	11	13	36	5215.09	50
Pg 11	5.5	8.5	8.5	12.0	21	38	11	14	40	5215.11	50
Pg 13	8.0	11.0	11.0	15.0	24	44	13	16	44	5215.13	50
Pg 16	8.0	11.0	11.0	15.0	24	44	13	16	44	5215.16	50
Pg 21	12.5	16.0	16.0	20.5	30	48	14	20	52	5215.21	25
Pg 29	19.0	23.0	23.0	27.5	38	60	14	24	65	5215.29	10

Erhältlich mit Dichteinsatz gemäss EN 45545. Bei Anfragen oder Bestellung bitte ein F vor die Artikelnummer setzen.

Available with sealing inserts conformity with EN 45545. When placing an inquiry, prefix the article number by the capital F.

Winkel 90° Messing mit Innen- und Aussengewinde

Elbow 90° nickel-plated brass with internal and external thread

Anschlussgewinde metrisch | Entry thread metric

Material:	Messing vernickelt	Material:	Nickel-plated brass
O-Ring:	NBR	O-ring:	NBR
Einsatztemperatur:	-40°C / +100°C	Temperature range:	-40°C / +100°C
Schutzart:	IP 54	Protection class:	IP 54
Weitere Schutzart:	IP 68, wenn Anschlussgewinde abgedichtet	Further protection:	IP 68, if the entry thread is sealed

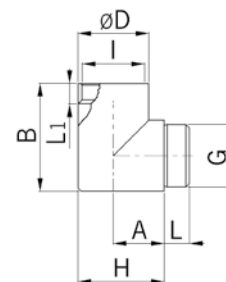

mit O-Ring								with O-ring		
G	I	D	L	L1	A	B	H	Art.-Nr. Art. No.		
		mm	mm	mm	mm	mm	mm			
M12x1.5	M12x1.5	15	5.0	7	13	25	20	5612	50	
M16x1.5	M16x1.5	19	6.5	7	16	29	26	5617	50	
M20x1.5	M20x1.5	24	6.0	10	19	37	31	5620	50	
M25x1.5	M25x1.5	29	7.5	10	23	42	37	5625	25	
M32x1.5	M32x1.5	36	8.5	11	26	50	44	5632	25	
M40x1.5	M40x1.5	46	9.5	17	34	67	57	5640	10	
M50x1.5	M50x1.5	56	9.0	17	41	77	69	5650	10	



Anschlussgewinde Pg | Entry thread Pg

mit O-Ring								with O-ring		
G	I	D	L	L1	A	B	H	Art.-Nr. Art. No.		
		mm	mm	mm	mm	mm	mm			
Pg 7	Pg 7	16	7.0	7	13	23	21	5607	50	
Pg 9	Pg 9	18	7.0	7	15	26	24	5609	50	
Pg 11	Pg 11	22	8.0	8	18	31	29	5611	50	
Pg 13	Pg 13	24	10.0	10	19	34	31	5613	50	
Pg 16	Pg 16	26	10.0	10	20	36	33	5616	50	
Pg 21	Pg 21	34	11.0	11	24	46	41	5621	25	
Pg 29	Pg 29	41	11.0	11	28	52	49	5629	20	
Pg 36	Pg 36	52	12.0	17	38	82	64	5636	10	



Anschlussgewinde metrisch | Entry thread metric

Material:	Messing vernickelt	Material:	Nickel-plated brass
O-Ring:	NBR	O-ring:	NBR
Einsatztemperatur:	-40°C / +100°C	Temperature range:	-40°C / +100°C
Schutzart:	IP 54	Protection class:	IP 54
Weitere Schutzart:	IP 68, wenn Anschlussgewinde abgedichtet	Further protection:	IP 68, if the entry thread is sealed

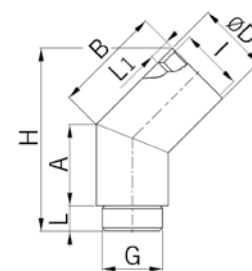

mit O-Ring								with O-ring		
G	I	D	L	L1	A	B	H	Art.-Nr. Art. No.		
		mm	mm	mm	mm	mm	mm			
M16x1.5	M16x1.5	19	6.5	7	13	18	26	5717	50	
M20x1.5	M20x1.5	24	6.0	10	17	23	33	5720	50	
M25x1.5	M25x1.5	29	7.5	10	18	25	36	5725	25	
M32x1.5	M32x1.5	36	8.5	11	21	28	41	5732	25	



Anschlussgewinde Pg | Entry thread Pg

mit O-Ring								with O-ring		
G	I	D	L	L1	A	B	H	Art.-Nr. Art. No.		
		mm	mm	mm	mm	mm	mm			
Pg 11	Pg 11	22	8	11	16	20	30	5711	50	
Pg 16	Pg 16	26	10	12	18	23	34	5716	50	
Pg 21	Pg 21	34	11	12	21	26	39	5721	25	
Pg 29	Pg 29	41	8	16	27	32	-	5729	25	



Flanschwinkel 90° Zinkdruckguss

Flanged elbow 90° zinc diecasting

Anschlussgewinde metrisch | Entry thread metric

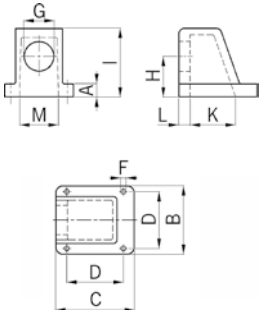

Material: Zinkdruckguss
 Dichtung: NBR
 Einsatztemperatur: -40°C / +100°C
 Schutzart: IP 65
 Eigenschaften: Für spritzwasserdichte Montage an der Gehäusewandung mit Anschlussgewinde für Kabelverschraubung oder Schlauchverschraubung

Material: Zinc diecasting
 Seal: NBR
 Temperature range: -40°C / +100°C
 Protection class: IP 65
 Properties: For splash water-proof mounting on casing walls with entry thread for cable glands or conduit glands



mit 1 Anschlussgewinde										with 1 entry thread		Art.-Nr. Art. No.	
G	B/C mm	D mm	F mm	A mm	H mm	I mm	K mm	L mm	M mm				
M16x1.5	45 x 48	37	4.3	8	15.5	30	28	10.5	24	5517	10		
M20x1.5	53 x 56	44	5.5	8	18.0	35	34	10.5	24	5520	10		
M25x1.5	63 x 65	54	5.5	8	22.5	42	43	11.0	35	5525	5		
M32x1.5	71 x 75	60	5.5	10	27.0	52	53	11.0	38	5532	5		
M40x1.5	71 x 75	60	5.5	10	27.0	52	53	11.0	38	5540	5		
M50x1.5	89 x 93	72	6.5	11	33.5	69	65	18.0	50	5550	2		
M63x1.5	96 x 114	84	4.3	10	37.0	74	86	14.0	67	5563	2		

Anschlussgewinde Pg | Entry thread Pg



mit 1 Anschlussgewinde										with 1 entry thread		Art.-Nr. Art. No.	
G	B/C mm	D mm	F mm	A mm	H mm	I mm	K mm	L mm	M mm				
Pg 9	45 x 48	37	4.3	8	15.5	30	28	10.5	24	5509	10		
Pg 13	53 x 56	44	5.5	8	19.0	35	34	10.5	24	5513	10		
Pg 16	53 x 56	44	5.5	8	19.0	35	34	10.5	24	5516	10		
Pg 21	63 x 65	54	5.5	8	23.0	42	43	11.0	35	5521	10		
Pg 29	71 x 75	60	5.5	10	27.0	52	53	11.0	38	5529	10		
Pg 36	89 x 94	72	6.5	11	34.0	69	65	18.0	50	5536	10		

Anschlussgewinde Pg | Entry thread Pg

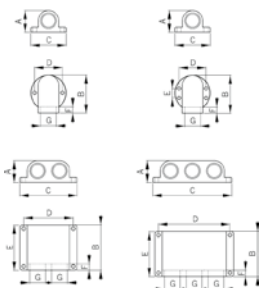

Material: Zinkdruckguss
 Farbe: Hammerschlaglackiert grau
 Dichtung: NBR
 Einsatztemperatur: -40°C / +100°C
 Schutzart: IP 65
 Eigenschaften: Für spritzwasserdichte Montage an der Gehäusewandung mit Anschlussgewinde für Kabelverschraubung oder Schlauchverschraubung

Material: Zinc diecasting
 Colour: Hammergrey enamel
 Seal: NBR
 Temperature range: -40°C / +100°C
 Protection class: IP 65
 Properties: For splash water-proof mounting on casing walls with entry thread for cable glands or conduit glands



Mit 1 bis 3 Anschlussgewinden										With 1 to 3 entry threads		Art.-Nr. Art. No.	
G	x	A mm	B mm	C mm	D mm	E mm	F mm	mm					
Pg 16	1 x	31	42	42	36.0	-	11	2x4.5	5516.10	10			
Pg 21	1 x	40	60	60	52.5	-	12	2x5.2	5521.10	10			
Pg 29	1 x	51.5	76	66	54.0	36	12	4x5.5	5529.10	10			
Pg 36	1 x	62	90	85	73.0	30	12	4x5.5	5536.10	10			
Pg 16	2 x	34	70	91	79.0	58	10	4x5.5	5516.12	10			
Pg 16	3 x	34	70	124	111.0	56	10	4x5.5	5516.13	10			

Universal Kabeleinführung für Flach- und Rundkabel

Universal cable entry for flat and round cables

Für Flach- und Rundkabel | For flat and round cables

Material: Alu (AlMgSi0.5)
 Eigenschaften: Universal für ein oder mehrere Kabel, auch mit verschiedenen Abmessungen und Durchmessern. Max. Einbau von Flachkabeln 70x12 mm.
 Dichtung: NBR
 Einsatztemperatur: -40°C / +100°C
 Schutzart: IP 54 - IP 68

Material: Alu (AlMgSi0.5)
 Properties: Universally applicable for one or several cable(s) with various dimensions and diameters. Max. cable dimension 70x12 mm.
 Seal: NBR
 Temperature range: -40°C / +100°C
 Protection class: IP 54 - IP 68

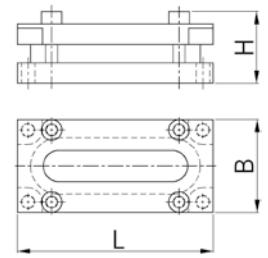

Aluminium Gehäuse zweiteilig
 Mit Dichtscheibe
 Universeller Dichtungseinsatz

Two-piece aluminium housing
 With sealing washer
 Universal sealing insert

L x B mm		H mm	Art.-Nr. Art. No.	
95x45	70.0x12.0	35	1370.15	5
95x45	49.0x4.5	35	1370.15.49.04	5
95x45	2x49.0x4.5	35	1370.15.49.45	5
95x45	63.0x12.0	35	1370.15.63.12	5
95x45	max.70.0x12.0	35	1370.15.30	5



Technischer Hinweis

Technical note

Vollgummi-Dichteinsätze auf die entsprechende Kabeldimension aufbohren (Rundkabel Ø +1 mm)

Drill solid rubber inserts to match the appropriate cable diameter (round cables Ø +1 mm)

Dichteinsätze ohne Bohrung lassen sich gut bearbeiten, wenn sie vorher auf mindestens -25°C gefroren wurden.

When frozen to at least -25°C, the solid sealing inserts are easy to drill.

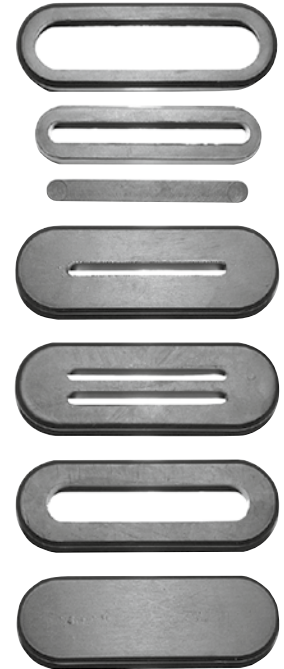
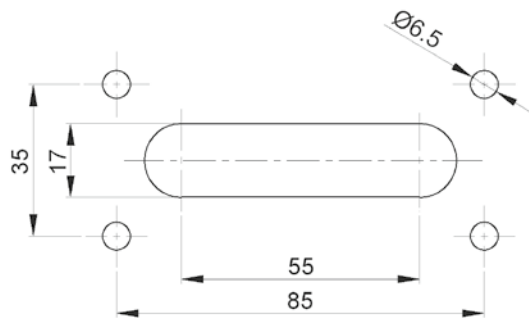

Stopfbuchsen Messing nach DIN 46320-C4-MS

Cable glands nickel-plated brass according to DIN 46320-C4-MS

Kurzes Anschlussgewinde metrisch | Short entry thread metric

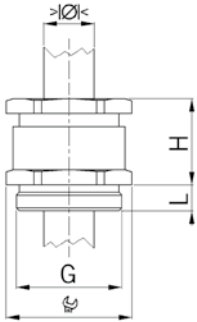

Material: Messing vernickelt
 Dichtung: NBR
 Einsatztemperatur: -20°C / +80°C
 Schutzart: IP 54

Material: Nickel-plated brass
 Seal: NBR
 Temperature range: -20°C / +80°C
 Protection class: IP 54



Einteiliger Einschnittring
 nicht durchgehend isolierend

One piece sealing ring
 not overall length insulated

G	> Ø < min mm	> Ø < max mm	Ø mm	H mm	L mm	Art.-Nr. Art. No.	
M12x1.5	5.0	7.0	14/13	15	5	B 112	100
M16x1.5	6.0	8.0	18/15	15	5	B 117	100
M20x1.5	8.0	10.0	22/18	19	6	B 120.10	50
M20x1.5	10.0	12.0	22/20	19	6	B 120.12	50
M20x1.5	12.0	14.0	22/20	19	6	B 120.14	50
M25x1.5	15.0	17.0	30/28	23	7	B 125	50
M32x1.5	24.0	26.0	40/37	26	8	B 132	25
M40x1.5	33.0	35.0	50/47	30	8	B 140	20
M50x1.5	39.0	41.0	57/54	34	9	B 150	10
M63x1.5	45.0	47.0	66/60	35	10	B 163	10

Langes Anschlussgewinde metrisch | Long entry thread metric



Einteiliger Einschnittring
 nicht durchgehend isolierend

One piece sealing ring
 not overall length insulated

G	> Ø < min mm	> Ø < max mm	Ø mm	H mm	L mm	Art.-Nr. Art. No.	
M12x1.5	5.0	7.0	14/13	15	10	B 212	100
M16x1.5	6.0	8.0	18/15	15	10	B 217	100
M20x1.5	8.0	10.0	22/18	19	10	B 220.10	50
M20x1.5	10.0	12.0	22/20	19	10	B 220.12	50
M20x1.5	12.0	14.0	22/20	19	10	B 220.14	50
M25x1.5	15.0	17.0	30/28	23	12	B 225	50
M32x1.5	24.0	26.0	40/37	26	12	B 232	25
M40x1.5	33.0	35.0	50/47	30	14	B 240	20
M50x1.5	39.0	41.0	57/54	34	14	B 250	10
M63x1.5	45.0	47.0	66/60	35	14	B 263	10

Stopfbuchsen Messing nach DIN 46320-C4-MS

Cable glands nickel-plated brass according to DIN 46320-C4-MS

Kurzes Anschlussgewinde Pg | Short entry thread Pg

Material: Messing vernickelt
 Dichtung: NBR
 Einsatztemperatur: -20°C / +80°C
 Schutzart: IP 54

Material: Nickel-plated brass
 Seal: NBR
 Temperature range: -20°C / +80°C
 Protection class: IP 54

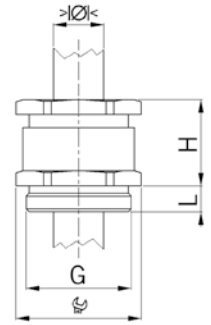

Einteiliger Einschnittring
 nicht durchgehend isolierend

One piece sealing ring
 not overall length insulated

G	$\gt;\varnothing<$ min mm	$\gt;\varnothing<$ max mm	 mm	H mm	L mm	Art.-Nr. Art. No.	
Pg 7	5.0	7.0	14/13	15	5	B 107	50
Pg 9	4.0	10.0	17/15	15	5	B 109	50
Pg 11	6.5	12.0	20/18	17	6	B 111	50
Pg 13	6.5	13.5	22/20	20	6	B 113	50
Pg 16	6.5	16.0	24/22	22	6	B 116	50
Pg 21	9.0	20.0	30/28	24	7	B 121	50
Pg 29	17.0	28.0	40/37	26	8	B 129	25
Pg 36	23.0	34.0	50/47	30	9	B 136	10
Pg 42	29.0	40.0	57/54	34	10	B 142	10
Pg 48	35.0	46.0	64/60	37	10	B 148.48	10

Langes Anschlussgewinde Pg | Long entry thread Pg

Einteiliger Einschnittring
 nicht durchgehend isolierend

One piece sealing ring
 not overall length insulated

G	$\gt;\varnothing<$ min mm	$\gt;\varnothing<$ max mm	 mm	H mm	L mm	Art.-Nr. Art. No.	
Pg 9	4.0	10.0	17/15	15	15	B 209	50
Pg 11	6.5	12.0	20/18	17	15	B 211	50
Pg 13	6.5	13.5	22/20	20	15	B 213	50
Pg 16	6.5	16.0	24/22	22	15	B 216	50
Pg 21	9.0	20.0	30/28	24	15	B 221	50
Pg 29	17.0	28.0	40/37	26	15	B 229	25
Pg 36	23.0	34.0	50/47	30	15	B 236	10
Pg 42	29.0	40.0	57/54	34	15	B 242	10
Pg 48	35.0	46.0	64/60	37	15	B 248.48	10



Stopfbuchsen Messing mit Klemmbacken

Cable glands nickel-plated brass with clamps

Kurzes Anschlussgewinde metrisch | Short entry thread metric

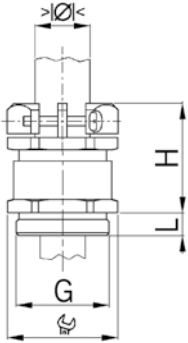

Material: Messing vernickelt
 Dichtung: NBR
 Einsatztemperatur: -20°C / +80°C
 Schutzart: IP 54

Material: Nickel-plated brass
 Seal: NBR
 Temperature range: -20°C / +80°C
 Protection class: IP 54



Einteiliger Einschnittring
 nicht durchgehend isolierend

One piece sealing ring
 not overall length insulated

G	$\gt;\varnothing<$ min mm	$\gt;\varnothing<$ max mm	\varnothing mm	H mm	L mm	Art.-Nr. Art. No.	
M12x1.5	5.0	7.0	14/17	22	5	1803.12	50
M16x1.5	6.0	8.0	17/20	25	6	1803.17	50
M20x1.5	8.0	10.0	24/27	26	6	1803.20	50
M25x1.5	15.0	17.0	30/35	28	6	1803.25	25
M32x1.5	24.0	26.0	40/43	29	6	1803.32	25
M40x1.5	33.0	35.0	50/55	33	7	1803.40	10

Kurzes Anschlussgewinde Pg | Short entry thread Pg



Einteiliger Einschnittring
 nicht durchgehend isolierend

One piece sealing ring
 not overall length insulated

G	$\gt;\varnothing<$ min mm	$\gt;\varnothing<$ max mm	\varnothing mm	H mm	L mm	Art.-Nr. Art. No.	
Pg 7	6.0	8.0	14/16	22	5	1803.07	50
Pg 9	8.0	10.0	17/19	25	6	1803.09	50
Pg 11	10.0	12.0	20/22	26	6	1803.11	50
Pg 13	12.0	14.0	22/24	27.5	6.5	1803.13	50
Pg 16	14.0	16.0	24/27	28.5	6.5	1803.16	50
Pg 21	14.0	16.0	30/34	33	7	1803.21	25
Pg 29	24.0	26.0	40/42	36	8	1803.29	25
Pg 36	30.0	32.0	50/52	41	9	1803.36	10
Pg 42	39.0	41.0	57/59	45	10	1803.42	10
Pg 48	45.0	47.0	64/64	48	10	1803.48.48	10

Stopfbuchsen Messing mit Trompete und Klemmbacken

Cable glands nickel-plated brass with trumpet and clamps

Kurzes Anschlussgewinde metrisch | Short entry thread metric

Material: Messing vernickelt
 Dichtung: NBR
 Einsatztemperatur: -20°C / +80°C
 Schutzart: IP 54

Material: Nickel-plated brass
 Seal: NBR
 Temperature range: -20°C / +80°C
 Protection class: IP 54

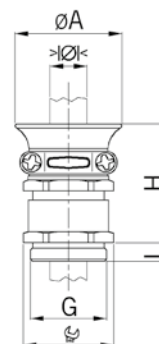

Einteiliger Einschnittring
 nicht durchgehend isolierend

One piece sealing ring
 not overall length insulated

G	> Ø < min mm	> Ø < max mm	 mm	H mm	L mm	ØA mm	Art.-Nr. Art. No.	
M16x1.5	6.0	8.0	18/17	29	5	22	1801.17	50
M20x1.5	8.0	10.0	22/20	31	6	26	1801.20.10	50
M20x1.5	10.0	12.0	22/22	32	6	29	1801.20.12	50
M20x1.5	12.0	14.0	22/24	34	6	32	1801.20.14	50
M25x1.5	15.0	17.0	30/30	37	7	38	1801.25	50
M32x1.5	24.0	26.0	40/41	43	8	50	1801.32	25



Kurzes Anschlussgewinde Pg | Short entry thread Pg

Einteiliger Einschnittring
 nicht durchgehend isolierend

One piece sealing ring
 not overall length insulated

G	> Ø < min mm	> Ø < max mm	 mm	H mm	L mm	ØA mm	Art.-Nr. Art. No.	
Pg 9	6.0	9.0	17	29	6	22	1801.09	50
Pg 11	8.0	12.0	20	31	6	26	1801.11	50
Pg 13	9.0	14.0	22	32	6	29	1801.13	50
Pg 16	10.0	16.0	24	34	6	32	1801.16	50
Pg 21	14.0	21.0	30	37	7	38	1801.21	50
Pg 29	18.0	30.0	40	43	8	50	1801.29	25



Stopfbuchsen Messing mit Schutztülle und Klemmbacken

Cable glands nickel-plated brass with antikink nozzle and clamps

Kurzes Anschlussgewinde metrisch | Short entry thread metric

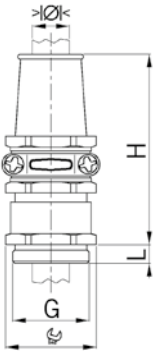



Material: Messing vernickelt
 Dichtung: NBR
 Knickschutztülle: NBR
 Einsatztemperatur: -20°C / +80°C
 Schutzart: IP 65 wenn Anschlussgewinde abgedichtet

Material: Nickel-plated brass
 Seal: NBR
 antikink nozzle: NBR
 Temperature range: -20°C / +80°C
 Protection class: IP 65 if the entry thread is sealed



Einteiliger Einschnittring
 nicht durchgehend isolierend

One piece sealing ring
 not overall length insulated

G	> Ø <		 mm	H mm	L mm	Art.-Nr. Art. No.	
	min mm	max mm					
M12x1.5	3.5	5.0	14/15	43	5	1852.12.05	25
M16x1.5	5.5	7.0	17/18	44	6	1852.16.07	25
M20x1.5	5.5	7.0	20/22	49	6	1852.20.07	25
M20x1.5	7.5	9.0	20/22	49	6	1852.20.09	25
M20x1.5	9.0	11.0	22/22	54	6	1852.20.11	25
M20x1.5	11.0	13.0	22/22	54	6	1852.20.13	25
M20x1.5	13.0	15.0	24/24	58	6	1852.20.15	25
M25x1.5	13.5	15.0	30/30	71	7	1852.25.15	25
M25x1.5	15.0	17.0	30/30	71	7	1852.25.17	25
M25x1.5	17.0	19.0	30/30	71	7	1852.25.19	25
M25x1.5	18.0	20.0	30/30	71	7	1852.25.20	25
M32x1.5	21.0	23.0	40/40	81	8	1852.32.23	1
M32x1.5	23.0	25.0	40/40	81	8	1852.32.25	1
M40x1.5	23.0	26.0	50/50	99	9	1852.40.26	1
M40x1.5	27.0	30.0	50/50	99	9	1852.40.30	1
M40x1.5	30.0	33.0	50/50	99	9	1852.40.33	1
M40x1.5	32.0	35.0	50/50	99	9	1852.40.35	1

Stopfbuchsen Messing mit Schutztülle und Klemmbacken

Cable glands nickel-plated brass with antikink nozzle and clamps

Kurzes Anschlussgewinde Pg | Short entry thread Pg

Material: Messing vernickelt
 Dichtung: NBR
 Knickschutztülle: NBR
 Einsatztemperatur: -20°C / +80°C
 Schutzart: IP 65 wenn Anschlussge-
 winde abgedichtet

Material: Nickel-plated brass
 Seal: NBR
 antikink nozzle: NBR
 Temperature range: -20°C / +80°C
 Protection class: IP 65 if the entry thread
 is sealed



Einteiliger Einschnittring
 nicht durchgehend isolierend

One piece sealing ring
 not overall length insulated







G	>Ø< min mm	>Ø< max mm	mm	H mm	L mm	Art.-Nr. Art. No.	
Pg 7	3.5	5.0	14/16	46	5	1852.07.05	50
Pg 9	5.5	7.0	17/19	45	6	1852.09.07	50
Pg 11	5.5	7.0	20/22	45	6	1852.11.07	50
Pg 11	7.5	9.0	20/22	49	6	1852.11.09	50
Pg 13	7.5	9.0	22/24	54	6	1852.13.09	25
Pg 13	9.0	11.0	22/24	54	6	1852.13.11	25
Pg 13	11.0	13.0	22/24	54	6	1852.13.13	25
Pg 16	11.5	13.0	24/27	58	6	1852.16.13	25
Pg 16	13.0	15.0	24/27	58	6	1852.16.15	25
Pg 21	13.5	15.0	30/34	71	7	1852.21.15	25
Pg 21	15.0	17.0	30/34	71	7	1852.21.17	25
Pg 21	17.0	19.0	30/34	71	7	1852.21.19	25
Pg 21	18.0	20.0	30/34	71	7	1852.21.20	25
Pg 29	18.0	20.0	40/42	71	8	1852.29.20	1
Pg 29	21.0	23.0	40/42	82	8	1852.29.23	1
Pg 29	23.0	25.0	40/42	82	8	1852.29.25	1
Pg 36	23.0	26.0	50/52	101	9	1852.36.26	1
Pg 36	27.0	30.0	50/52	101	9	1852.36.30	1
Pg 36	30.0	33.0	50/52	99	9	1852.36.33	1
Pg 36	32.0	35.0	50/52	99	9	1852.36.35	1
Pg 42	32.0	35.0	57/62	104	10	1852.42.35	1
Pg 42	35.0	38.0	57/62	104	10	1852.42.38	1
Pg 42	36.0	40.0	57/62	104	10	1852.42.40	1
Pg 48	36.0	40.0	64/68	110	10	1852.48.48.40	1
Pg 48	40.0	44.0	64/68	110	10	1852.48.48.44	1



	Progress® EMV Messing Progress® nickel-plated brassCEIM	EMV Rapid EMC Rapid	EMV easyCONNECT EMC easyCONNECT	EMV Standard EMC Standard	EMV powerCONNECT EMC powerCONNECT	EMV Serie 85 EMC Serie 85	EMV mit Knickschutzfeder EMC with anti-kink spring	EMV für Hochtemperatur EMC for high temperatures	EMV Kombi-Schlauchverschraubung EMC combination conduit gland	EMV Hohlgeflechtsverschraubung EMC conduit gland for braiddings	EMV-Adapter EMC Adapter	EMV Zubehör EMC Accessories	EMV Gegenmutter mit Schneidzähnen EMC locknut with cutting teeth	Erdungsflaschen Grounding strap
Ausführung / Version														
Kompressionstechnik Compression technology	•	•	•	•	•	•	•	•	•	-	•	-	-	-
EMV Technik / EMC tapping bonding technology														
Kontaktscheibe Contact disc	•	-	-	-	-	-	-	-	-	-	-	-	-	-
Kontaktfeder Contact spring	-	•	-	-	-	-	-	-	-	-	-	-	-	-
Kontaktbüchse Contact bushing	•	-	•	-	-	•	•	•	•	•	-	-	-	-
Presshülse Compression sleeve	-	-	-	•	-	-	-	-	-	-	-	-	-	-
Spannzange Collet chuck	-	-	-	-	•	-	-	-	-	-	-	-	-	-
Gewinde / Thread														
Anschlussgewinde metrisch Entry thread metric	•	•	•	•	•	•	•	•	•	•	•	-	•	•
Anschlussgewinde Pg Entry thread Pg	•	A	•	A	A	•	•	•	A	•	-	•	•	-
Kurzes Anschlussgewinde (Standard) Short entry thread (standard)	•	•	•	•	•	•	•	A	A	-	-	-	-	-
Langes Anschlussgewinde Long entry thread	•	•	•	•	A	A	•	•	•	•	-	-	-	-
Dichteinsatz / Sealing ring														
für Rundkabel for round cables	•	•	•	•	•	•	•	•	•	•	-	-	-	-
für Schläuche for conduits	-	-	-	-	-	-	-	•	•	•	-	-	-	-
einteiliger Dichteinsatz one-piece sealing insert	•	A	•	A	A	•	•	•	A	•	-	-	-	-
zweiteiliger Dichteinsatz two-piece sealing insert	-	•	-	•	•	-	-	-	-	-	-	-	-	-
Multi-Dichteinsatz sealing insert for several cables	-	•	-	-	-	-	A	-	-	-	-	-	-	-
TPE-Dichteinsatz (Standard) standard sealing insert (TPE)	•	•	•	•	•	•	-	•	-	•	-	-	-	-
FPM-Dichteinsatz FPM sealing insert	A	A	-	A	A	A	•	A	-	A	-	-	-	-
Dichteinsatz nach EN 45545 Sealing insert acc. to EN 45545	A	A	A	A	A	A	-	-	-	A	-	-	-	-
Anwendung / Characteristics														
Zugentlastung Strain relief	•	•	•	•	•	•	•	•	-	•	-	-	-	-
Knickschutz Anti-kink protection	-	-	-	-	-	•	-	-	-	-	-	-	-	-
Schirmgeflecht wird weitergeführt Continuation of braided shield	•	•	-	-	•	-	-	-	-	-	-	-	-	-
Schirmgeflecht wird nicht weitergeführt Without continuation of braided shield	•	•	•	•	•	•	•	•	•	•	-	-	-	-
variabler Schirm-Klemmbereich Extent of clamping range for the shield	++	+++	+	+++	+	+	+	+	+	+	-	-	-	-
niedrige Transferimpedanz Minimal transfer impedance	+	++	++	+++	+++	++	++	++	++	++	-	-	-	-
hohe Ableitströme (1.6 kA - 3 kA) High leakage currents	-	-	-	+++	+++	-	-	-	-	-	-	-	-	-
Demontierbarkeit ohne Beschädigung des Kabelschirms Can be dismantled without damaging the shield	-	+++	+	++	++	+	+	-	-	-	-	-	-	-
Installationsfreundlichkeit (kleiner Zeitaufwand) Easy installation (quick assembly)	+++	++	+	+	+	+	+	+	+	+	-	-	-	-

• trifft zu / lieferbar applicable / available - trifft nicht zu / nicht lieferbar not applicable / not available +++ hervorragend geeignet very well suited ++ sehr gut geeignet well suited + gut geeignet suited A auf Anfrage upon request



<p>Kabelverschraubungen Progress® EMV easyCONNECT Messing mit Kontaktfeder Cable glands Progress® EMC easyCONNECT nickel-plated brass with contact spring</p>		<p>91</p>	<p>1</p>
<p>Kabelverschraubungen Progress® EMV Rapid Messing mit Kontaktscheibe Cable glands Progress® EMC Rapid nickel-plated brass with contact disc</p>		<p>92 - 93</p>	<p>2</p>
<p>Kabelverschraubungen Progress® EMV Messing mit Kontakthülse Cable glands Progress® EMC nickel-plated brass with contact sleeve</p>		<p>94 - 97</p>	<p>3</p>
<p>Kabelverschraubungen Progress® EMV Messing mit Kontakthülse für hohe Temperaturen Cable glands Progress® EMC nickel-plated brass with contact sleeve for high temperature applications</p>		<p>98 - 99</p>	<p>4</p>
<p>Kabelverschraubungen Progress® EMV Messing mit Knickschutzfeder Cable glands Progress® EMC nickel-plated brass with antikink spring</p>		<p>100 - 101</p>	<p>5</p>
<p>Kabelverschraubungen Progress® EMV powerCONNECT Messing Cable glands Progress® EMC powerCONNECT nickel-plated brass</p>		<p>102 - 103</p>	<p>6</p>
<p>Kabelverschraubungen Progress® EMV Serie 85 Messing mit Spannzange Cable glands Progress® EMC Series 85 nickel-plated brass with collet chuck</p>		<p>104 - 105</p>	<p>7</p>
<p>Zubehör zu EMV-Kabelverschraubungen EMC cable glands accessories</p>		<p>106 - 107</p>	<p>8</p>

9

10

11

12



Die elektromagnetische Verträglichkeit (EMV) im industriellen Umfeld besitzt einen besonderen Stellenwert, da gerade komplexe Maschinen und Anlagen äusserst anfällig für elektromagnetische Störungen sind. Den unerwünschten EMV-Effekten lässt sich jedoch mit einer wirkungsvollen Schirmung aller Komponenten entgegensteuern. Eine gute Schirmung reduziert einerseits die Störaussendung eines elektrischen Betriebsmittels und verringert gleichzeitig dessen Anfälligkeit für elektromagnetische Beeinträchtigungen.

Allerdings müssen nicht nur die Kabel selbst, sondern auch die restlichen Installationskomponenten einen Schirmcharakter aufweisen. Kabelverschraubungen als passive Bauteile müssen sicherstellen, dass die Qualität der Schirmung an den sensiblen Verbindungsstellen erhalten bleibt und es keine Schirmungsverluste gibt. Insofern ist es notwendig, nicht nur eine maximal geschirmte Leitung zu verwenden, sondern auch EMV-gerechte Kabelverschraubungen einzusetzen. Obwohl für diese Bauteile keine eigenständige EMV-Norm existiert, tragen sie wesentlich dazu bei, dass die vorgeschriebenen EMV-Auflagen der Hersteller erfüllt werden können.

Mit sechs unterschiedlichen, EMV-gerechten Kabelverschraubungen bieten wir dem Kunden das passende Produkt und die ideale Kontaktierungsvariante für jeden Anwendungsfall. Bei der Kabelverschraubung Progress® EMV easyCONNECT und auch easyCONNECT Multi Messing erfolgt die Kontaktierung über eine innovative Federklammer. Bei der neuen Progress® EMV powerCONNECT garantiert die fortschrittliche Presshülse eine sichere 360° Schirmkontaktierung auf kleinstem Raum.

Alle Produktreihen zeichnen sich durch eine leichte Montage aus. Das renommierte Schweizer EMV-Labor MONTENA EMC SA bescheinigt den AGRO Kabelverschraubungen ausserdem eine niedrige Transferimpedanz und hohe Strombelastbarkeit. Beides sind gängige Gütekriterien für die Qualität einer Schirmung. Um hier Bestwerte zu erzielen, bezieht AGRO den EMV-Spezialisten bei der Entwicklung neuer Produkte schon von Beginn an ein.

The electromagnetic compatibility (EMC) in the industrial sector plays a key role because complex machines and systems are extremely susceptible to electromagnetic interference. Such undesired EMC effects, however, can be counteracted with the effective shielding of all components. On the one hand, good shielding reduces the amount of interference emitted by an electrical apparatus while at the same time reducing its susceptibility to impaired performance due to electromagnetic effects.

Not only cables themselves but also all other components that are part of the installation must provide shielding characteristics. As passive components, cable glands must ensure that the quality of the shielding at sensitive interconnection points remains intact and that there are no losses due to the shielding. For this reason, it's necessary to not only use a maximally shielded cable but also add EMC-compliant cable glands. Although there is no separate EMC standard for these components, they play a large contribution towards making it possible to meet the EMC characteristics prescribed by manufacturers.

With six different EMC-compatible cable glands, AGRO offers its customers the appropriate product and the ideal types of contact for each type of application. With the Progress® EMC easyCONNECT and easyCONNECT Multi brass cable gland, contact is established through an innovative spring clip. The new Progress® EMC powerCONNECT with its advanced compression sleeve ensures reliable 360° shield contact in a very compact unit.

All these product lines stand out due to their easy assembly. Furthermore, the renowned Swiss EMC laboratory MONTENA EMC SA has certified AGRO cable glands for lowest transfer impedance and high current carrying capacity. Both are established criteria for the quality of shielding. In order to achieve a top grade, AGRO involves EMC specialists from the very beginning of new-product development.



Progress® EMV easyCONNECT Messing

Die **Kabelverschraubung Progress® EMV easyCONNECT** gewährleistet volle Installationskontrolle und gleicht Toleranzen in den Schirmdicken für einen sicheren Schirmabgriff aus. Das Federsystem ermöglicht eine gute und sichere Schirmkontaktierung sowohl bei partiell abisolierten Abschirmkabeln als auch bei vollständig freigelegten Kabelschirmen.

1 Optimale Schirmkontaktierung

Die kraftvolle, schonende Klemmung des Kabelschirms garantiert einen hervorragenden Schirmkontakt und sorgt für extrem niedrige Transferimpedanzen. Durch die spezielle Formgebung der Kontaktfeder ist nicht nur ein grosser Schirmklemmbereich sondern auch die Demontierbarkeit der Kabelverschraubung ohne Zerstörung des EMV-Geflechtes gegeben.

Progress® EMC easyCONNECT nickel-plated brass

The **cable glands Progress® EMC easyCONNECT** guarantees full control during installation and compensates for tolerances in shielding thicknesses to make a secure screened tap connection. The spring system provides for a very good contact of partially stripped shielding cables equally as well as for the contact of completely exposed cable shields which can be directed further.

1 Optimal shield contact

The powerful, protective clamping of the cable shield guarantees excellent shield contact and provides for the smallest possible transfer impedance. The shape of the contact spring not only allows for a large clamping range to the shield but also for easy disassembly without damaging the EMC braid.

Progress® EMV easyCONNECT Multi

Die **Progress® easyCONNECT Multi** ist die erste Kabelverschraubung, die das Einführen von mehreren geschirmten Kabeln in ein Gehäuse erlaubt – und dies mit kraftvollem und sicherem Schirmabgriff. Bei einem kleinen Installationsraum für geschirmte Leitungen ist Progress® EMV easyConnect Multi genau das richtige. Egal, ob die zu verarbeitenden Kabel Durchmesser immer den gleichen oder unterschiedliche Durchmesser aufweisen, ob es sich um vorkonfektionierte oder unkonfektionierte Leitungen oder Hybridkabel handelt: Durch die innovative Kontaktfeder ist eine problemlose Erdung möglich. Anhand der aufgeführten Bilder sehen Sie nur einen kleinen Ausschnitt der vielen Möglichkeiten.

Progress® EMC easyCONNECT Multi

The **Progress® easyCONNECT Multi** is the first cable gland that allows for the entry of several shielded cables into a housing – at any moment granting a strong and safe tap connection.

For shielded cables in limited space conditions, Progress® EMV easyConnect Multi is the perfect solution. Whether for cables of the same or different diameters, or for preassembled, non-preassembled or hybrid cables: The innovative contact spring facilitates problem-free earthing. The presented pictures show only a small selection of the many possibilities.

Sechs unterschiedliche Kontaktierungsvarianten

Six different types of contact

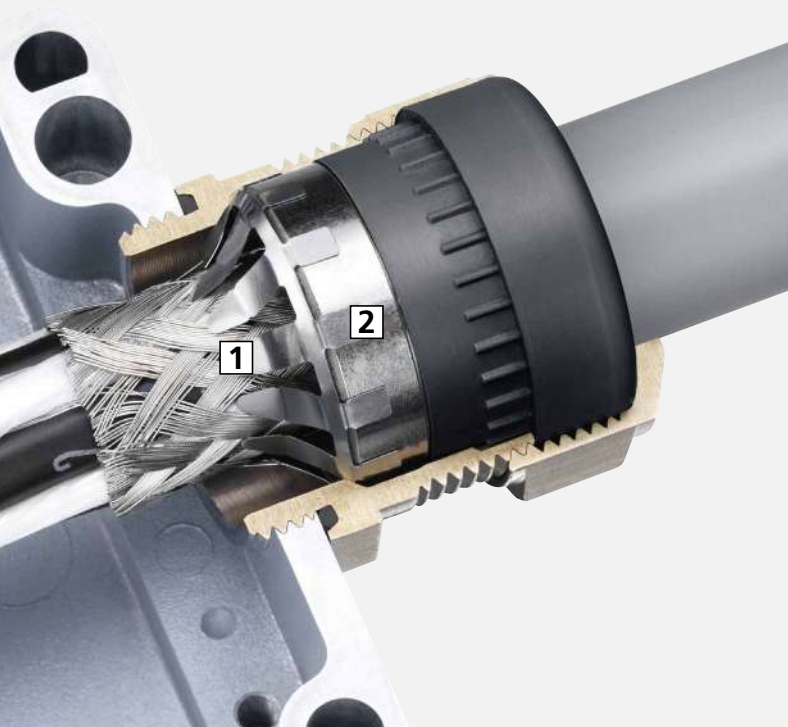

Progress® EMV Rapid Messing

Die **Kabelverschraubung mit den zwei Kontaktierungsvarianten** für eine sehr schnelle und einfache Schirmkontaktierung durch eine integrierte Kontaktscheibe. Sie ermöglicht die gute Kontaktierung sowohl von partiell abisolierten Abschirmkabeln als auch von vollständig freigelegten Kabelschirmen, die auch weitergeführt werden können.

1 Niedriger Übergangswiderstand

Die grossflächigen, flexiblen Zungen der Kontaktscheibe maximieren die Abgriffsfläche am Schirmgeflecht und erlauben eine zeitsparende Montage.

2 Flexible Kontaktierungsmöglichkeiten

Für eine höherwertige 360° Schirmkontaktierung, kann die Kontaktscheibe ausgestossen werden und das zugeschnittene Schirmgeflecht über die Kontakthülse direkt mit der Kontaktfläche im Unterteil der Kabelverschraubung kontaktiert werden.

Progress® EMC Rapid nickel-plated brass

The cable gland with two contact options. An integrated contact disc allows for easy and fast contact to the shield of partially stripped cables as well as of fully stripped cables which shields are being extended.

1 Low contact resistance

The flexible coils on the contact disc, with their large surface area, maximise the gripping surface on the braided shield.

2 Flexible terminating methods

If a 360° contact is required, the contact disc can be extruded and the trimmed shield can be connected to the contact bushing. The interlocking "sealing insert/contact sleeve" combination ensures that the contact washer continually presses on the bottom part.

Progress® EMV Messing

Kabelverschraubungen Progress® EMV aus Messing mit der bewährten Kontakthülse ermöglichen eine Schirmkontaktierung von 360° bei in der Kabelverschraubung endendem Schirmgeflecht. Die massgebende Kantengeometrie der Kontakthülse verhindert hierbei ein Abscheren des Schirmgeflechts.

1 Kleinste Übergangswiderstände

Der konzentrische Schirmabgriff von 360° bürgt für kleinste Übergangswiderstände.

2 Permanenter Kontaktdruck

Die ineinandergreifende Kombination „Dichteinsatz-Kontakthülse“ garantiert einen permanenten Kontaktdruck des Schirmgeflechts am Unterteil.

Progress® EMC nickel-plated brass

Progress® EMC cable glands made of brass and with the time-proven contact sleeve make 360° contact with braided shield which terminates at the cable gland. The decisive edge geometry of the contact sleeve prevents any shearing of the braided shield.

1 Low contact resistance

The immense 360° contact surface ensures low contact resistance.

2 Permanent contact pressure

The interlocking "sealing insert/contact sleeve" combination ensures permanent contact pressure of the braided shield against the lower part.

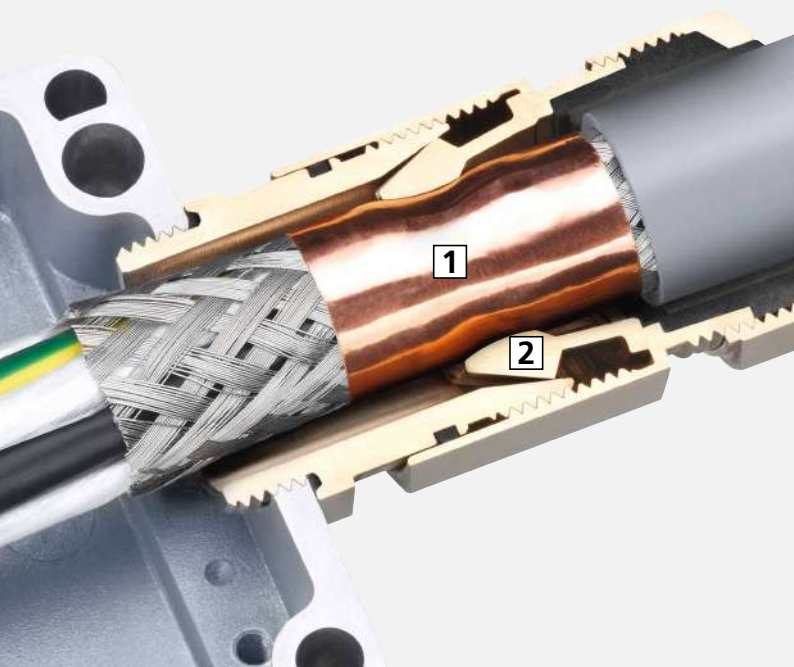

Progress® EMV Serie 85 Messing

Die patentierten Kabelverschraubungen **Progress® EMV Serie 85** aus Messing sorgen für eine besonders niederimpedante Verbindung zwischen Schirmgeflecht und Metallgehäuse bei gleichzeitig sicherer Kabeleinführung.

1 Optimale Schirmkontaktierung

Das Zwischenstück mit den grossen Schlüsselflächen ermöglicht eine einwandfreie Kontaktierung des Schirmgeflechtes durch die wegverstärkenden Spannzangensegmente über 360°. Das Kupferband sorgt für eine gleichmässige Kraftverteilung des Schirmgeflechtes.

2 Höchste Ableitströme

Die massive Spannzange gewährleistet einen konzentrischen, niederimpedanten Schirmabgriff und bewältigt dauerhaft Ableitströme bis 1.6 kA – kurzzeitig 3 kA.

Progress® EMC Series 85 nickel-plated brass

The patented **cable glands Progress® EMC Series 85** made of brass provide an especially low-impedance connection between the braided shield and the metal cabinet as well as safe cable entry.

1 Optimal shield contact

The connector piece, which is secured with the help of large wrenching surfaces, enables perfect contact of the braided shield by means of a collet chuck with segments that slide together around 360°. The copper tap grants equal transmission of the compression power.

2 Highest leakage currents

The massive collet guarantees a concentric, low-impedance screened tap connection and handles leakage currents of up to 1.6 kA continuous – and short term to 3 kA.

Progress® EMV powerCONNECT

Die **Progress® EMV powerCONNECT** mit der neuartigen fortschrittlichen Presshülse garantiert eine sichere 360° Schirmkontaktierung. Der direkte Übergang vom Geflecht auf das Unterteil der Kabelverschraubung gewährleistet einen erstaunlich niedrigen Übergangswiderstand. Dank geringer Bauhöhe eignet sich die Verschraubung ideal für den Einsatz in kleinstem Raum.

1 Geringe Übergangswiderstände

Durch den direkten Kontakt Geflecht-Kabelverschraubungskonus ergeben sich äusserst geringe Übergangswiderstände.

2 Höchste Ableitströme

Dauerhaft hoher Kontaktdruck durch die fixierte Presshülse und das Anziehen des Zwischenstücks auf Block ermöglichen höchste Ableitströme welche nur durch den Schirmquerschnitt begrenzt werden.

3 Grosse Flexibilität

Hohe Dichtigkeit bei grosser Flexibilität. Die zweiteiligen Dichteinsätze ermöglichen eine grosse Bandbreite im Klemmbereich bei unveränderter Schutzart (IP 68 / IP 69).

Progress® EMC powerCONNECT

Progress® EMC powerCONNECT, with its new, advanced compression sleeve, ensures reliable 360° shield contact in a very compact unit. The direct transfer from the shielding to the cable gland's lower part ensures extremely low transfer resistance.

1 Low transfer resistance

As a result of the direct contact between the cable's shielding and the cable gland's cone, transfer resistance is very low.

2 High leakage currents

Lasting high contact pressure, which results from the fixed compression sleeve and the complete tightening of the middle piece, maximises grounding of leakage currents, the extent of which is limited only by the shield's cross-sectional area.

3 High flexibility

Excellent sealing performance with high flexibility. The two-part sealing inserts facilitate a large spectrum in the clamping range at a particular protection class (IP 68 / IP 69).

Progress EMV easyCONNECT Multi

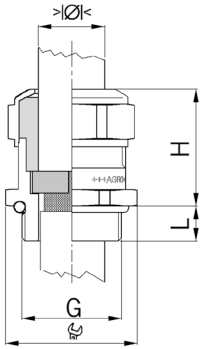

Material: Messing vernickelt
 Kontaktfeder: Federstahl 1.4310
 Dichtung: TPE
 O-Ring: NBR
 Zugentlastung: Ausführung A nach EN 62444
 Einsatztemperatur: -40°C / +100°C
 Schutzart: IP 68 (bis 10 bar)
 Weitere Schutzart: IP 69
 Eigenschaften: Für zeitsparende und sichere Montage von partiell abisolierten sowie durchgehend geschirmten Kabeln

Material: Nickel-plated brass
 Contact spring: Spring steel 1.4310
 Seal: TPE
 O-ring: NBR
 Strain relief: Version A acc. to EN 62444
 Temperature range: -40°C / +100°C
 Protection class: IP 68 (up to 10 bar)
 Further protection: IP 69
 Properties: For a quick installation of partially dismantled cables as well as thoroughly shielded cables



Einteiliger Dichteinsatz
 nicht durchgehend isolierend

One-piece sealing insert
 not overall length insulated

Bei einem kleinen Installationsraum für geschirmte Leitungen ist Progress® EMV easyConnect Multi genau das richtige. Egal, ob die zu verarbeitenden Kabeldurchmesser immer den gleichen oder unterschiedliche Durchmesser aufweisen, ob es sich um vorkonfektionierte oder unkonfektionierte Leitungen oder Hybridkabel handelt: Durch die innovative Kontaktfeder ist eine problemlose Erdung möglich. Anhand der aufgeführten Bilder sehen Sie nur einen kleinen Ausschnitt der vielen Möglichkeiten.

For shielded cables in limited space conditions, Progress® EMC easyConnect Multi is the perfect solution. Whether for cables of the same or different diameters, or for preassembled, non-preassembled or hybrid cables: The innovative contact spring facilitates problem-free earthing. The presented pictures show only a small selection of the many possibilities.

You specify the number of cable entries and the relevant diameters, and we will supply the EMC Multi cable gland to meet your needs.

Sie definieren Anzahl und Durchmesser der Kabeleinführungen – wir liefern Ihnen Ihre individuelle EMV Multi Kabelverschraubung.

Auf Anfrage lieferbar:
 Ausführungen in Stahl A2 und A4
 Anschlussgewinde Pg und NPT
 Mit FPM-Dichteinsätzen für hohe Temperaturen
 Mit F-Dichteinsätzen nach EN 45545

Available on request:
 Executions in steel A2 and A4
 Entry thread Pg and NPT
 With FPM sealing inserts for high temperatures
 With sealing inserts of type F in accordance with EN 45545



Mit Standard Bohrungen
 With standard hole layouts



Mit individuellen Bohrungen
 With customized hole layouts

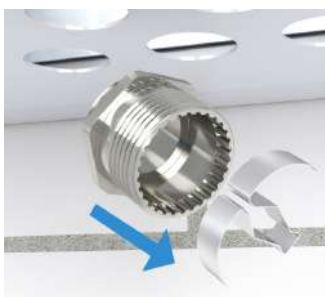

Kabelverschraubungen Progress® EMV easyCONNECT Messing mit Kontaktfeder

Cable glands Progress® EMC easyCONNECT nickel-plated brass with contact spring

Kurzes Anschlussgewinde metrisch | Short entry thread metric

Material: Messing vernickelt
 Kontaktfeder: Federstahl 1.4310
 Dichtung: TPE
 O-Ring: NBR
 Zugentlastung: Ausführung A nach EN 62444
 Einsatztemperatur: -60°C / +100°C
 Schutzart: IP 68 (bis 10 bar)
 Weitere Schutzart: IP 69
 Eigenschaften: Für zeitsparende und sichere Montage von partiell abisolierten sowie durchgehend geschirmten Kabeln

Material: Nickel-plated brass
 Contact spring: Spring steel 1.4310
 Seal: TPE
 O-ring: NBR
 Strain relief: Version A acc. to EN 62444
 Temperature range: -60°C / +100°C
 Protection class: IP 68 (up to 10 bar)
 Further protection: IP 69
 Properties: For a quick and safe installation of partially dismantled cables as well as thoroughly shielded cables

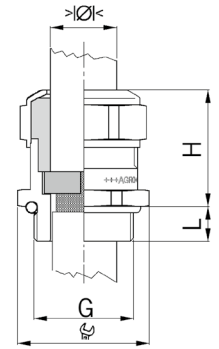

Progress MS EMV easyCONNECT



Zweiteiliger Dichteinsatz nicht durchgehend isolierend		Two-piece sealing insert not overall length insulated									
G	>Ø< min mm	>Ø< max mm	>Ø< min mm	>Ø< max mm	Ø mm	H mm	L mm	i info	Art.-Nr. Art. No.		
M12x1.5	-	-	3.5	5.0	15	22	5	1	1083.12.050	50	
M12x1.5	-	-	5.0	6.5	15	22	5	1	1083.12.065	50	
M16x1.5	6.0	8.0	8.0	10.5	18	25	5	-	1083.17	50	
M20x1.5	8.0	11.0	11.0	15.0	24	27	6	-	1083.20	50	
M25x1.5	12.5	16.0	16.0	20.5	30	33	7	-	1083.25	25	
M32x1.5	17.0	21.0	21.0	25.5	36	33	8	-	1083.32	25	
M40x1.5	24.0	28.5	28.5	33.0	46	38	8	2	1083.40	10	
M50x1.5	33.0	37.0	37.0	42.0	55	42	9	2	1083.50	10	
M63x1.5	40.0	46.0	46.0	52.0	70	42	10	2	1083.63	5	

1 = Einteiliger Dichteinsatz
 2 = Zulassungen in Vorbereitung

Erhältlich mit Dichteinsatz gemäss EN 45545. Bei Anfragen oder Bestellung bitte ein F vor die Artikelnummer setzen.

Auf Anfrage lieferbar:
 Anschlussgewinde Pg und NPT
 Ausführungen in Stahl A2 und A4



Langes Anschlussgewinde metrisch | Long entry thread metric

Progress MS EMV easyCONNECT



Zweiteiliger Dichteinsatz nicht durchgehend isolierend		Two-piece sealing insert not overall length insulated									
G	>Ø< min mm	>Ø< max mm	>Ø< min mm	>Ø< max mm	Ø mm	H mm	L mm	i info	Art.-Nr. Art. No.		
M12x1.5	-	-	3.5	5.0	15	22	10	1	1183.12.050	50	
M12x1.5	-	-	5.0	6.5	15	22	10	1	1183.12.065	50	
M16x1.5	6.0	8.0	8.0	10.5	18	25	10	-	1183.17	50	
M20x1.5	8.0	11.0	11.0	15.0	24	27	10	-	1183.20	50	
M25x1.5	12.5	16.0	16.0	20.5	30	33	11	-	1183.25	25	
M32x1.5	17.0	21.0	21.0	25.5	36	33	13	-	1183.32	25	
M40x1.5	24.0	28.5	28.5	33.0	46	38	13	2	1183.40	10	
M50x1.5	33.0	37.0	37.0	42.0	55	42	14	2	1183.50	10	
M63x1.5	40.0	46.0	46.0	52.0	70	42	14	2	1183.63	5	

1 = Einteiliger Dichteinsatz
 2 = Zulassungen in Vorbereitung

Erhältlich mit Dichteinsatz gemäss EN 45545. Bei Anfragen oder Bestellung bitte ein F vor die Artikelnummer setzen.

Auf Anfrage lieferbar:
 Anschlussgewinde Pg und NPT
 Ausführungen in Stahl A2 und A4



Kabelverschraubungen Progress® EMV Rapid Messing mit Kontaktscheibe

Cable glands Progress® EMC Rapid nickel-plated brass with contact disc

Kurzes Anschlussgewinde metrisch | Short entry thread metric

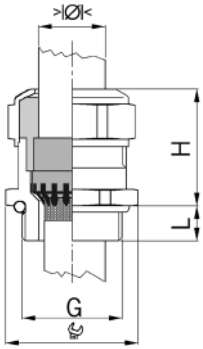

Material: Messing vernickelt
 Kontakthülse: Messing vernickelt
 Kontaktscheibe: Rostfreier Stahl A2
 Dichtung: TPE
 O-Ring: NBR
 Zugentlastung: Ausführung A nach EN 62444
 Einsatztemperatur: -40°C / +100°C
 Schutzart: IP 68 (bis 10 bar)
 Weitere Schutzart: IP 69
 Eigenschaften: Für zeitsparende Montage von partiell abisolierten sowie durchgehend geschirmten Kabeln

Material: Nickel-plated brass
 Contact sleeve: Nickel-plated brass
 Contact disc: Stainless steel A2
 Seal: TPE
 O-ring: NBR
 Strain relief: Version A acc. to EN 62444
 Temperature range: -40°C / +100°C
 Protection class: IP 68 (up to 10 bar)
 Further protection: IP 69
 Properties: For a quick installation of partially dismantled cables as well as thoroughly shielded cables

Progress MS EMC Rapid



Einteiliger Dichteinsatz
 nicht durchgehend isolierend

One-piece sealing insert
 not overall length insulated

G	>math>\varnothing</math> min mm	>math>\varnothing</math> max mm	 mm	H mm	L mm	Art.-Nr. Art. No.	
M12x1.5	4.5	6.0	15	20	5	1081.12.060	50
M12x1.5	6.0	7.5	15	20	5	1081.12.075	50
M16x1.5	6.0	8.0	18	23	5	1081.17.080	50
M16x1.5	8.0	10.0	18	25	5	1081.17.100	50
M20x1.5	8.0	11.0	24	25	6	1081.20.110	50
M20x1.5	11.0	14.0	24	27	6	1081.20.140	50
M25x1.5	13.0	16.0	30	30	7	1081.25.160	25
M25x1.5	16.0	19.0	30	33	7	1081.25.190	25
M32x1.5	18.0	21.0	36	32	8	1081.32.210	25
M32x1.5	21.0	25.0	36	32	8	1081.32.250	25

Langes Anschlussgewinde metrisch | Long entry thread metric



Progress MS EMC Rapid

Einteiliger Dichteinsatz
 nicht durchgehend isolierend

One-piece sealing insert
 not overall length insulated

G	>math>\varnothing</math> min mm	>math>\varnothing</math> max mm	 mm	H mm	L mm	Art.-Nr. Art. No.	
M12x1.5	4.5	6.0	15	20	10	1181.12.060	50
M12x1.5	6.0	7.5	15	20	10	1181.12.075	50
M16x1.5	6.0	8.0	18	23	10	1181.17.080	50
M16x1.5	8.0	10.0	18	25	10	1181.17.100	50
M20x1.5	8.0	11.0	24	25	10	1181.20.110	50
M20x1.5	11.0	14.0	24	27	10	1181.20.140	50
M25x1.5	13.0	16.0	30	30	11	1181.25.160	25
M25x1.5	16.0	19.0	30	33	11	1181.25.190	25
M32x1.5	18.0	21.0	36	32	13	1181.32.210	25
M32x1.5	21.0	25.0	36	32	13	1181.32.250	25

Kabelverschraubungen Progress® EMV Rapid Messing mit Kontaktscheibe

Cable glands Progress® EMC Rapid nickel-plated brass with contact disc

Kurzes Anschlussgewinde Pg | Short entry thread Pg

Material: Messing vernickelt
 Kontakthülse: Messing vernickelt
 Kontaktscheibe: Rostfreier Stahl A2
 Dichtung: TPE
 O-Ring: NBR
 Einsatztemperatur: -40°C / +100°C
 Schutzart: IP 68 (bis 10 bar)
 Weitere Schutzart: IP 69
 Eigenschaften: Für zeitsparende Montage von partiell abisolierten sowie durchgehend geschirmten Kabeln

Material: Nickel-plated brass
 Contact sleeve: Nickel-plated brass
 Contact disc: Stainless steel A2
 Seal: TPE
 O-ring: NBR
 Temperature range: -40°C / +100°C
 Protection class: IP 68 (up to 10 bar)
 Further protection: IP 69
 Properties: For a quick installation of partially dismantled cables as well as thoroughly shielded cables

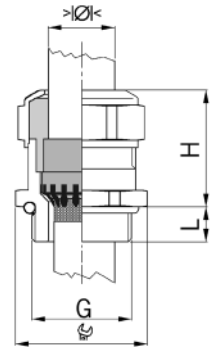

Progress MS EMC Rapid



Einteiliger Dichteinsatz
 nicht durchgehend isolierend

One-piece sealing insert
 not overall length insulated

G	> Ø < min mm	> Ø < max mm	 mm	H mm	L mm	Art.-Nr. Art. No.	
Pg 7	4.5	6.0	15	20	6	1081.07.060	50
Pg 7	6.0	7.5	15	20	6	1081.07.075	50
Pg 9	6.0	8.0	18	23	6	1081.09.080	50
Pg 9	8.0	10.0	18	25	6	1081.09.100	50
Pg 11	5.5	8.5	21	25	6	1081.11.085	50
Pg 11	8.5	12.0	21	25	6	1081.11.120	50
Pg 13	8.0	11.0	24	25	6	1081.13.110	50
Pg 13	11.0	14.0	24	27	6	1081.13.140	50
Pg 16	8.0	11.0	24	24	6	1081.16.110	50
Pg 16	11.0	14.0	24	27	6	1081.16.140	50
Pg 21	13.0	16.0	30	30	7	1081.21.160	25
Pg 21	16.0	19.0	30	33	7	1081.21.190	25
Pg 29	19.0	23.0	38	33	8	1081.29.230	25
Pg 29	23.0	25.5	38	32	8	1081.29.255	25



Langes Anschlussgewinde Pg | Long entry thread Pg

Progress MS EMC Rapid



Einteiliger Dichteinsatz
 nicht durchgehend isolierend

One-piece sealing insert
 not overall length insulated

G	> Ø < min mm	> Ø < max mm	 mm	H mm	L mm	Art.-Nr. Art. No.	
Pg 7	4.5	6.0	15	20	10	1181.07.060	50
Pg 7	6.0	7.5	15	20	10	1181.07.075	50
Pg 9	6.0	8.0	18	23	10	1181.09.080	50
Pg 9	8.0	10.0	18	25	10	1181.09.100	50
Pg 11	5.5	8.5	21	25	10	1181.11.085	50
Pg 11	8.5	12.0	21	25	10	1181.11.120	50
Pg 13	8.0	11.0	24	25	10	1181.13.110	50
Pg 13	11.0	14.0	24	27	10	1181.13.140	50
Pg 16	8.0	11.0	24	24	10	1181.16.110	50
Pg 16	11.0	14.0	24	27	10	1181.16.140	50
Pg 21	13.0	16.0	30	30	12	1181.21.160	25
Pg 21	16.0	19.0	30	33	12	1181.21.190	25
Pg 29	19.0	23.0	38	33	12	1181.29.230	25
Pg 29	23.0	25.5	38	32	12	1181.29.255	25



Kabelverschraubungen Progress® EMV Messing mit Kontakthülse

Cable glands Progress® EMC nickel-plated brass with contact sleeve

Kurzes Anschlussgewinde metrisch | Short entry thread metric

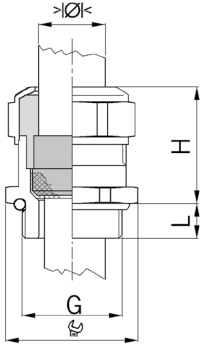

Material:	Messing vernickelt	Material:	Nickel-plated brass
Kontakthülse:	Messing vernickelt	Contact sleeve:	Nickel-plated brass
Dichtung:	TPE	Seal:	TPE
O-Ring:	NBR	O-ring:	NBR
Zugentlastung:	Ausführung A nach EN 62444	Strain relief:	Version A acc. to EN 62444
Einsatztemperatur:	-40°C / +100°C	Temperature range:	-40°C / +100°C
Schutzart:	IP 68 (bis 10 bar)	Protection class:	IP 68 (up to 10 bar)
Weitere Schutzart:	IP 69	Further protection:	IP 69
Eigenschaften:	Sehr guter Schirmkontakt über die Kontakthülse bei in der Kabelverschraubung endendem Schirmgeflecht	Properties:	Excellent shield contact through the contact sleeve with the braided shield terminating in the screwed cable gland

Progress MS EMC



Einteiliger Dichteinsatz
nicht durchgehend isolierend

One-piece sealing insert
not overall length insulated

G	>Ø< min mm	>Ø< max mm	Ø mm	H mm	L mm	i info	Art.-Nr. Art. No.	
M8x1.25	2.5	3.5	11	15	5	1	1080.08.035	50
M8x1.25	3.0	4.0	11	15	5	1	1080.08.040	50
M10x1.5	3.0	4.0	13	16	5	1	1080.10.040	50
M10x1.5	4.0	6.0	13	16	5	1	1080.10.060	50
M12x1.5	4.5	6.0	15	20	5	-	1080.12.060	50
M12x1.5	6.0	7.5	15	20	5	-	1080.12.075	50
M16x1.5	6.0	8.0	18	23	5	-	1080.17.080	50
M16x1.5	8.0	10.0	18	25	5	-	1080.17.100	50
M20x1.5	8.0	11.0	24	25	6	-	1080.20.110	50
M20x1.5	11.0	14.0	24	27	6	-	1080.20.140	50
M25x1.5	13.0	16.0	30	30	7	-	1080.25.160	25
M25x1.5	16.0	19.0	30	33	7	-	1080.25.190	25
M32x1.5	18.0	21.0	36	32	8	-	1080.32.210	25
M32x1.5	21.0	25.0	36	32	8	-	1080.32.250	25
M40x1.5	24.0	28.5	46	34	8	-	1080.40.285	10
M40x1.5	28.5	32.0	46	34	8	-	1080.40.320	10
M50x1.5	33.0	37.0	55	36	9	-	1080.50.370	10
M50x1.5	37.0	41.0	55	36	9	-	1080.50.410	10
M63x1.5	40.0	46.0	70	39	10	-	1080.63.460	5
M63x1.5	46.0	50.0	70	39	10	-	1080.63.500	5
M75x1.5	50.0	56.0	80	40	11	-	1080.75.560	1
M80x2.0	56.0	65.0	95	45	18	-	1080.80.650	1
M85x2.0	63.0	70.0	95	45	18	-	1080.85.700	1
M95x2.0	68.0	75.0	110	52	20	-	1080.95.750	1

1 = Metrisches Regelgewinde (mit VDE Testreport)

1 = Metric coarse-pitch thread (with VDE test report)

Erhältlich mit Dichteinsatz gemäss EN 45545. Bei Anfragen oder Bestellung bitte ein F vor die Artikelnummer setzen.

Available with sealing inserts conformity with EN 45545. When placing an inquiry, prefix the article number by the capital F.

Kabelverschraubungen Progress® EMV Messing mit Kontakthülse

Cable glands Progress® EMC nickel-plated brass with contact sleeve

Langes Anschlussgewinde metrisch | Long entry thread metric

Material: Messing vernickelt
 Kontakthülse: Messing vernickelt
 Dichtung: TPE
 O-Ring: NBR
 Zugentlastung: Ausführung A nach EN 62444
 Einsatztemperatur: -40°C / +100°C
 Schutzart: IP 68 (bis 10 bar)
 Weitere Schutzart: IP 69
 Eigenschaften: Sehr guter Schirmkontakt über die Kontakthülse bei in der Kabelverschraubung endendem Schirmgeflecht

Material: Nickel-plated brass
 Contact sleeve: Nickel-plated brass
 Seal: TPE
 O-ring: NBR
 Strain relief: Version A acc. to EN 62444
 Temperature range: -40°C / +100°C
 Protection class: IP 68 (up to 10 bar)
 Further protection: IP 69
 Properties: Excellent shield contact through the contact sleeve with the braided shield terminating in the screwed cable gland

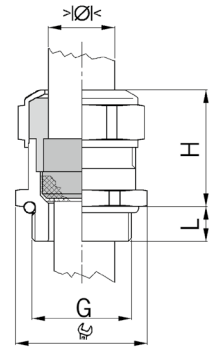

Progress MS EMC



Einteiliger Dichteinsatz
 nicht durchgehend isolierend

One-piece sealing insert
 not overall length insulated

G	>Ø< min mm	>Ø< max mm	 mm	H mm	L mm	i info	Art.-Nr. Art. No.	
M8x1.25	2.5	3.5	11	15	10	1	1180.08.035	50
M8x1.25	3.0	4.0	11	15	10	1	1180.08.040	50
M10x1.5	3.0	4.0	13	16	10	1	1180.10.040	50
M10x1.5	4.0	6.0	13	16	10	1	1180.10.060	50
M12x1.5	4.5	6.0	15	20	10	-	1180.12.060	50
M12x1.5	6.0	7.5	15	20	10	-	1180.12.075	50
M16x1.5	6.0	8.0	18	23	10	-	1180.17.080	50
M16x1.5	8.0	10.0	18	25	10	-	1180.17.100	50
M20x1.5	8.0	11.0	24	25	10	-	1180.20.110	50
M20x1.5	11.0	14.0	24	27	10	-	1180.20.140	50
M25x1.5	13.0	16.0	30	30	11	-	1180.25.160	25
M25x1.5	16.0	19.0	30	33	11	-	1180.25.190	25
M32x1.5	18.0	21.0	36	32	13	-	1180.32.210	25
M32x1.5	21.0	25.0	36	32	13	-	1180.32.250	25
M40x1.5	24.0	28.5	46	34	13	-	1180.40.285	10
M40x1.5	28.5	32.0	46	34	13	-	1180.40.320	10
M50x1.5	33.0	37.0	55	36	14	-	1180.50.370	10
M50x1.5	37.0	41.0	55	36	14	-	1180.50.410	10
M63x1.5	40.0	46.0	70	39	14	-	1180.63.460	5
M63x1.5	46.0	50.0	70	39	14	-	1180.63.500	5



1 = Metrisches Regelgewinde (mit VDE Testreport)

1 = Metric coarse-pitch thread (with VDE test report)

Erhältlich mit Dichteinsatz gemäß EN 45545. Bei Anfragen oder Bestellung bitte ein F vor die Artikelnummer setzen.

Available with sealing inserts conformity with EN 45545. When placing an inquiry, prefix the article number by the capital F.

Kabelverschraubungen Progress® EMV Messing mit Kontakthülse

Cable glands Progress® EMC nickel-plated brass with contact sleeve

Kurzes Anschlussgewinde Pg | Short entry thread Pg

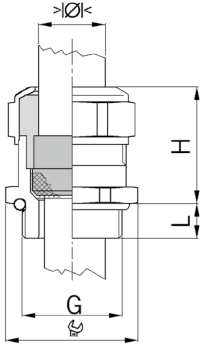

Material: Messing vernickelt
 Kontakthülse: Messing vernickelt
 Dichtung: TPE
 O-Ring: NBR
 Einsatztemperatur: -40°C / +100°C
 Schutzart: IP 68 (bis 10 bar)
 Weitere Schutzart: IP 69
 Eigenschaften: Sehr guter Schirmkontakt über die Kontakthülse bei in der Kabelverschraubung endendem Schirmgeflecht

Material: Nickel-plated brass
 Contact sleeve: Nickel-plated brass
 Seal: TPE
 O-ring: NBR
 Temperature range: -40°C / +100°C
 Protection class: IP 68 (up to 10 bar)
 Further protection: IP 69
 Properties: Excellent shield contact through the contact sleeve with the braided shield terminating in the screwed cable gland



Progress MS EMC



Einteiliger Dichteinsatz
 nicht durchgehend isolierend

One-piece sealing insert
 not overall length insulated

G	>Ø< min mm	>Ø< max mm	Ø mm	H mm	L mm	Art.-Nr. Art. No.	
Pg 7	4.5	6.0	15	20	6	1080.07.060	50
Pg 7	6.0	7.5	15	20	6	1080.07.075	50
Pg 9	6.0	8.0	18	23	6	1080.09.080	50
Pg 9	8.0	10.0	18	25	6	1080.09.100	50
Pg 11	5.5	8.5	21	23	6	1080.11.085	50
Pg 11	8.5	12.0	21	23	6	1080.11.120	50
Pg 13	8.0	11.0	24	25	6	1080.13.110	50
Pg 13	11.0	14.0	24	27	6	1080.13.140	50
Pg 16	8.0	11.0	24	24	6	1080.16.110	50
Pg 16	11.0	14.0	24	27	6	1080.16.140	50
Pg 21	13.0	16.0	30	30	7.5	1080.21.160	25
Pg 21	16.0	19.0	30	33	7.5	1080.21.190	25
Pg 29	19.0	23.0	38	33	8	1080.29.230	25
Pg 29	23.0	25.5	38	32	8	1080.29.255	25
Pg 36	25.0	30.5	50	36	8	1080.36.305	10
Pg 36	30.5	35.0	50	34	8	1080.36.350	10
Pg 42	33.0	37.0	55	37	10	1080.42.370	10
Pg 42	37.0	41.0	55	36	10	1080.42.410	10
Pg 48	39.0	43.0	65	42	11	1080.48.430	10
Pg 48	43.0	46.5	65	40	11	1080.48.465	10

Erhältlich mit Dichteinsatz gemäss EN 45545. Bei Anfragen oder Bestellung bitte ein F vor die Artikelnummer setzen.

Available with sealing inserts conformity with EN 45545. When placing an inquiry, prefix the article number by the capital F.

Kabelverschraubungen Progress® EMV Messing mit Kontakthülse

Cable glands Progress® EMC nickel-plated brass with contact sleeve

Langes Anschlussgewinde Pg | Long entry thread Pg

Material: Messing vernickelt
 Kontakthülse: Messing vernickelt
 Dichtung: TPE
 O-Ring: NBR
 Einsatztemperatur: -40°C / +100°C
 Schutzart: IP 68 (bis 10 bar)
 Weitere Schutzart: IP 69
 Eigenschaften: Sehr guter Schirmkontakt über die Kontakthülse bei in der Kabelverschraubung endendem Schirmgeflecht

Material: Nickel-plated brass
 Contact sleeve: Nickel-plated brass
 Seal: TPE
 O-ring: NBR
 Temperature range: -40°C / +100°C
 Protection class: IP 68 (up to 10 bar)
 Further protection: IP 69
 Properties: Excellent shield contact through the contact sleeve with the braided shield terminating in the screwed cable gland

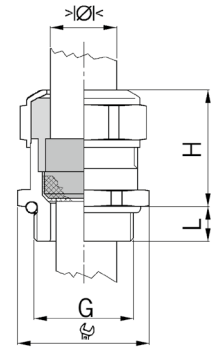

Progress MS EMC



Einteiliger Dichteinsatz
 nicht durchgehend isolierend

One-piece sealing insert
 not overall length insulated

G	>Ø< min mm	>Ø< max mm	 mm	H mm	L mm	Art.-Nr. Art. No.	
Pg 7	4.5	6.0	15	20	10	1180.07.060	50
Pg 7	6.0	7.5	15	20	10	1180.07.075	50
Pg 9	6.0	8.0	18	23	10	1180.09.080	50
Pg 9	8.0	10.0	18	25	10	1180.09.100	50
Pg 11	5.5	8.5	21	23	10	1180.11.085	50
Pg 11	8.5	12.0	21	23	10	1180.11.120	50
Pg 13	8.0	11.0	24	25	10	1180.13.110	50
Pg 13	11.0	14.0	24	27	10	1180.13.140	50
Pg 16	8.0	11.0	24	24	10	1180.16.110	50
Pg 16	11.0	14.0	24	27	10	1180.16.140	50
Pg 21	13.0	16.0	30	30	12	1180.21.160	25
Pg 21	16.0	19.0	30	33	12	1180.21.190	25
Pg 29	19.0	23.0	38	33	12	1180.29.230	25
Pg 29	23.0	25.5	38	32	12	1180.29.255	25
Pg 36	25.0	30.5	50	36	15	1180.36.305	10
Pg 36	30.5	35.0	50	34	15	1180.36.350	10
Pg 42	33.0	37.0	55	37	15	1180.42.370	10
Pg 42	37.0	41.0	55	36	15	1180.42.410	10
Pg 48	39.0	43.0	65	42	15	1180.48.430	10
Pg 48	43.0	46.5	65	40	15	1180.48.465	10

Erhältlich mit Dichteinsatz gemäss EN 45545. Bei Anfragen oder Bestellung bitte ein F vor die Artikelnummer setzen.

Available with sealing inserts conformity with EN 45545. When placing an inquiry, prefix the article number by the capital F.



Kabelverschraubungen Progress® EMV Messing mit Kontakthülse für hohe Temperaturen

Cable glands Progress® EMC nickel-plated brass with contact sleeve for high temperature applications

Kurzes Anschlussgewinde metrisch | Short entry thread metric

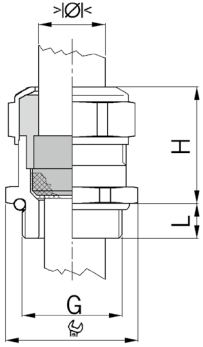

Material: Messing vernickelt
 Kontakthülse: Messing vernickelt
 Dichtung: FPM
 O-Ring: FPM
 Zugentlastung: Ausführung A nach EN 62444
 Einsatztemperatur: -40°C / +200°C
 Schutzart: IP 68 (bis 10 bar)
 Weitere Schutzart: IP 69
 Eigenschaften: Sehr guter Schirmkontakt über die Kontakthülse bei in der Kabelverschraubung endendem Schirmgeflecht

Material: Nickel-plated brass
 Contact sleeve: Nickel-plated brass
 Seal: FPM
 O-ring: FPM
 Strain relief: Version A acc. to EN 62444
 Temperature range: -40°C / +200°C
 Protection class: IP 68 (up to 10 bar)
 Further protection: IP 69
 Properties: Excellent shield contact through the contact sleeve with the braided shield terminating in the screwed cable gland



Einteiliger Dichteinsatz
 nicht durchgehend isolierend

One-piece sealing insert
 not overall length insulated

G	>Ø< min mm	>Ø< max mm	 mm	H mm	L mm	i info	Art.-Nr. Art. No.	
M10x1.5	3.0	4.0	13	16	5	1	1080.10.91.040	50
M10x1.5	4.0	6.0	13	16	5	1	1080.10.91.060	50
M12x1.5	4.5	6.0	15	20	5	-	1080.12.91.060	50
M12x1.5	6.0	7.5	15	20	5	-	1080.12.91.075	50
M16x1.5	6.0	8.0	18	23	5	-	1080.17.91.080	50
M16x1.5	8.0	10.0	18	25	5	-	1080.17.91.100	50
M20x1.5	8.0	11.0	24	25	6	-	1080.20.91.110	50
M20x1.5	11.0	14.0	24	27	6	-	1080.20.91.140	50
M25x1.5	13.0	16.0	30	30	7	-	1080.25.91.160	25
M25x1.5	16.0	19.0	30	33	7	-	1080.25.91.190	25
M32x1.5	18.0	21.0	36	32	8	-	1080.32.91.210	25
M32x1.5	21.0	25.0	36	32	8	-	1080.32.91.250	25

1 = Metrisches Regelgewinde

1 = Metric coarse-pitch thread

Langes Anschlussgewinde metrisch | Long entry thread metric



Einteiliger Dichteinsatz
 nicht durchgehend isolierend

One-piece sealing insert
 not overall length insulated

G	>Ø< min mm	>Ø< max mm	 mm	H mm	L mm	i info	Art.-Nr. Art. No.	
M10x1.5	3.0	4.0	13	16	10	1	1180.10.91.040	50
M10x1.5	4.0	6.0	13	16	10	1	1180.10.91.060	50
M12x1.5	4.5	6.0	15	20	10	-	1180.12.91.060	50
M12x1.5	6.0	7.5	15	20	10	-	1180.12.91.075	50
M16x1.5	6.0	8.0	18	23	10	-	1180.17.91.080	50
M16x1.5	8.0	10.0	18	25	10	-	1180.17.91.100	50
M20x1.5	8.0	11.0	24	25	10	-	1180.20.91.110	50
M20x1.5	11.0	14.0	24	27	10	-	1180.20.91.140	50
M25x1.5	13.0	16.0	30	30	11	-	1180.25.91.160	25
M25x1.5	16.0	19.0	30	33	11	-	1180.25.91.190	25
M32x1.5	18.0	21.0	36	32	13	-	1180.32.91.210	25
M32x1.5	21.0	25.0	36	32	13	-	1180.32.91.250	25

1 = Metrisches Regelgewinde

1 = Metric coarse-pitch thread

Kabelverschraubungen Progress® EMV Messing mit Kontakthülse für hohe Temperaturen

Cable glands Progress® EMC nickel-plated brass with contact sleeve for high temperature applications

Kurzes Anschlussgewinde Pg | Short entry thread Pg

Material: Messing vernickelt
 Kontakthülse: Messing vernickelt
 Dichtung: FPM
 O-Ring: FPM
 Einsatztemperatur: -40°C / +200°C
 Schutzart: IP 68 (bis 10 bar)
 Weitere Schutzart: IP 69
 Eigenschaften: Sehr guter Schirmkontakt über die Kontakthülse bei in der Kabelverschraubung endendem Schirmgeflecht

Material: Nickel-plated brass
 Contact sleeve: Nickel-plated brass
 Seal: FPM
 O-ring: FPM
 Temperature range: -40°C / +200°C
 Protection class: IP 68 (up to 10 bar)
 Further protection: IP 69
 Properties: Excellent shield contact through the contact sleeve with the braided shield terminating in the screwed cable gland

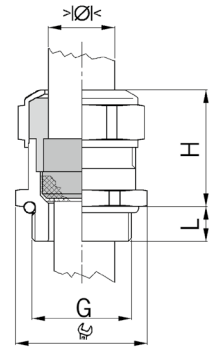

Einteiliger Dichteinsatz
 nicht durchgehend isolierend

One-piece sealing insert
 not overall length insulated

G	>Ø< min mm	>Ø< max mm	mm	H mm	L mm	Art.-Nr. Art. No.	
Pg 9	6.0	8.0	18	23	6	1080.09.91.080	50
Pg 9	8.0	10.0	18	25	6	1080.09.91.100	50
Pg 11	5.5	8.5	21	23	6	1080.11.91.085	50
Pg 11	8.5	12.0	21	23	6	1080.11.91.120	50
Pg 13	8.0	11.0	24	25	6	1080.13.91.110	50
Pg 13	11.0	14.0	24	27	6	1080.13.91.140	50
Pg 16	8.0	11.0	24	24	6	1080.16.91.110	50
Pg 16	11.0	14.0	24	27	6	1080.16.91.140	50
Pg 21	13.0	16.0	30	30	7.5	1080.21.91.160	25
Pg 21	16.0	19.0	30	33	7.5	1080.21.91.190	25
Pg 29	19.0	23.0	38	33	8	1080.29.91.230	25
Pg 29	23.0	25.5	38	32	8	1080.29.91.255	25



Langes Anschlussgewinde Pg | Long entry thread Pg



Einteiliger Dichteinsatz
 nicht durchgehend isolierend

One-piece sealing insert
 not overall length insulated

G	>Ø< min mm	>Ø< max mm	mm	H mm	L mm	Art.-Nr. Art. No.	
Pg 9	6.0	8.0	18	23	10	1180.09.91.080	50
Pg 9	8.0	10.0	18	25	10	1180.09.91.100	50
Pg 11	5.5	8.5	21	23	10	1180.11.91.085	50
Pg 11	8.5	12.0	21	23	10	1180.11.91.120	50
Pg 13	8.0	11.0	24	25	10	1180.13.91.110	50
Pg 13	8.5	12.0	24	27	10	1180.13.91.140	50
Pg 16	8.0	11.0	24	24	10	1180.16.91.110	50
Pg 16	11.0	14.0	24	27	10	1180.16.91.140	50
Pg 21	13.0	16.0	30	30	12	1180.21.91.160	25
Pg 21	16.0	19.0	30	33	12	1180.21.91.190	25
Pg 29	19.0	23.0	38	33	12	1180.29.91.230	25
Pg 29	23.0	25.5	38	32	12	1180.29.91.255	25



Kabelverschraubungen Progress® EMV Messing mit Knickschutzfeder

Cable glands Progress® EMC nickel-plated brass with antikink spring

Kurzes Anschlussgewinde metrisch | Short entry thread metric

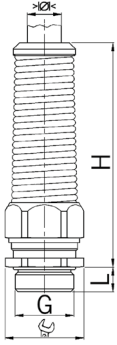

Material:	Messing vernickelt	Material:	Nickel-plated brass
Knickschutzfeder:	Rostfreier Stahl A2	Antikink spring:	Stainless steel A2
Dichtung:	TPE	Seal:	TPE
O-Ring:	NBR	O-ring:	NBR
Zugentlastung:	Ausführung A nach EN 62444	Strain relief:	Version A acc. to EN 62444
Einsatztemperatur:	-40°C / +100°C	Temperature range:	-40°C / +100°C
Schutzart:	IP 68	Protection class:	IP 68
Weitere Schutzart:	IP 69	Further protection:	IP 69
Eigenschaften:	Sehr guter Schirmkontakt über die Kontakthülse bei in der Kabelverschraubung endendem Schirmgeflecht	Properties:	Excellent shield contact through the contact sleeve with the braided shield terminating in the screwed cable gland

Progress MS EMC FKN



Einteiliger Dichteinsatz
nicht durchgehend isolierend

One-piece sealing insert
not overall length insulated

G	>Ø< min mm	>Ø< max mm	mm	H mm	L mm	i info	Art.-Nr. Art. No.	
M8x1.25	2.5	3.5	11	50	5	1	1080.08.52.035	10
M8x1.25	3.0	4.0	11	50	5	1	1080.08.52.040	10
M10x1.5	3.0	4.0	13	54	5	1	1080.10.52.040	10
M10x1.5	4.0	6.0	13	54	5	1	1080.10.52.060	10
M12x1.5	4.5	6.0	15	60	5	-	1080.12.52.060	10
M12x1.5	6.0	7.5	15	60	5	-	1080.12.52.075	10
M16x1.5	6.0	8.0	18	69	5	-	1080.17.52.080	10
M16x1.5	8.0	10.0	18	69	5	-	1080.17.52.100	10
M20x1.5	8.0	11.0	24	88	6	-	1080.20.52.110	10
M20x1.5	11.0	14.0	24	88	6	-	1080.20.52.140	10
M25x1.5	13.0	16.0	30	104	7	-	1080.25.52.160	10
M25x1.5	16.0	19.0	30	104	7	-	1080.25.52.190	10
M32x1.5	18.0	21.0	36	112	8	-	1080.32.52.210	5
M32x1.5	21.0	24.5	36	112	8	-	1080.32.52.245	5

1 = Metrisches Regelgewinde (mit VDE Testreport)

1 = Metric coarse-pitch thread (with VDE test report)

Erhältlich mit Dichteinsatz gemäss EN 45545. Bei Anfragen oder Bestellung bitte ein F vor die Artikelnummer setzen.

Available with sealing inserts conformity with EN 45545. When placing an inquiry, prefix the article number by the capital F.

Langes Anschlussgewinde auf Anfrage

Long entry thread available on request

Kabelverschraubungen Progress® EMV Messing mit Knickschutzfeder Cable glands Progress® EMC nickel-plated brass with antikink spring

Kurzes Anschlussgewinde Pg | Filet de raccordement Pg court

Material: Messing vernickelt
Knickschutzfeder: Rostfreier Stahl A2
Dichtung: TPE
O-Ring: NBR
Einsatztemperatur: -40°C / +100°C
Schutzart: IP 68
Eigenschaften: Sehr guter Schirmkontakt über die Kontakthülse bei in der Kabelverschraubung endendem Schirmgeflecht

Material: Nickel-plated brass
Antikink spring: Stainless steel A2
Seal: TPE
O-ring: NBR
Temperature range: -40°C / +100°C
Protection class: IP 68
Properties: Excellent shield contact through the contact sleeve with the braided shield terminating in the screwed cable gland

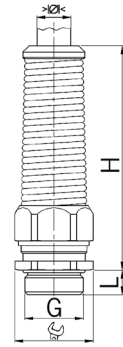

Progress MS EMC FKN



Einteiliger Dichteinsatz
nicht durchgehend isolierend

One-piece sealing insert
not overall length insulated

G	$\gt;\varnothing<$ min mm	$\gt;\varnothing<$ max mm	\varnothing mm	H mm	L mm	Art.-Nr. Art. No.	
Pg 7	4.5	6.0	15	60	6	1080.07.52.060	10
Pg 7	6.0	7.5	15	60	6	1080.07.52.075	10
Pg 9	6.0	8.0	18	69	6	1080.09.52.080	10
Pg 9	8.0	10.0	18	69	6	1080.09.52.100	10
Pg 11	6.0	8.0	18/21	69	6	1080.11.52.080	10
Pg 11	8.0	10.0	18/21	69	6	1080.11.52.100	10
Pg 13	8.0	11.0	24	88	6	1080.13.52.110	10
Pg 13	11.0	14.0	24	88	6	1080.13.52.140	10
Pg 16	8.0	11.0	24	88	6	1080.16.52.110	10
Pg 16	11.0	14.0	24	88	6	1080.16.52.140	10
Pg 21	13.0	16.0	30	104	7	1080.21.52.160	5
Pg 21	16.0	19.0	30	104	7	1080.21.52.190	5



Erhältlich mit Dichteinsatz gemäss EN 45545. Bei Anfragen oder Bestellung bitte ein F vor die Artikelnummer setzen.

Available with sealing inserts conformity with EN 45545. When placing an inquiry, prefix the article number by the capital F.

Langes Anschlussgewinde auf Anfrage

Long entry thread available on request

Kabelverschraubungen Progress® EMV powerCONNECT Messing

Cable glands Progress® EMC powerCONNECT nickel-plated brass

Kurzes Anschlussgewinde metrisch | Short entry thread metric

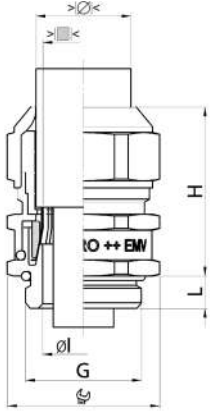

Material: Messing vernickelt
 Dichtung: TPE
 O-Ring: NBR
 Zugentlastung: Ausführung A nach EN 62444
 Einsatztemperatur: -60°C / +100°C
 Schutzart: IP 68 (bis 10 bar)
 Weitere Schutzart: IP 69
 Eigenschaften: Für hohe Ableitströme, konzentrische Schirmkontaktierung 360° mit tiefstem Übergangswiderstand und Transferimpedanz. Sehr geringe Bauhöhe.

Material: Nickel-plated brass
 Seal: TPE
 O-ring: NBR
 Strain relief: Version A acc. to EN 62444
 Temperature range: -60°C / +100°C
 Protection class: IP 68 (up to 10 bar)
 Further protection: IP 69
 Properties: For high leakage currents, concentric 360° shield contact ensure extremely low transfer resistance and transfer impedance. Compact design.



Zweiteiliger Dichteinsatz
 nicht durchgehend isolierend
 2 = Zulassungen in Vorbereitung

Two-piece sealing insert
 not overall length insulated
 2 = Approvals in preparation

G	> Ø < min mm	> Ø < max mm	> Ø < min mm	> Ø < max mm	> ■ < mm	Øl mm	H mm	L mm	i info	Art.-Nr. Art. No.		
M16x1.5	6.0	8.0	8.0	10.5	9.3	8.2	18	28	5	2	1084.17	25
M20x1.5	8.0	11.0	11.0	15.0	13.4	11.9	24	0	6	2	1084.20	25
M25x1.5	12.5	16.0	16.0	20.5	18.7	17.6	30	0	7	2	1084.25	25
M32x1.5	17.0	21.0	21.0	25.5	23.8	22.1	36	0	8	2	1084.32	25
M40x1.5	24.0	28.5	28.5	33.0	30.4	29.5	46	0	8	2	1084.40	10
M50x1.5	33.0	37.0	37.0	42.0	38.7	37.7	55	0	9	2	1084.50	10
M63x1.5	40.0	46.0	46.0	52.0	48.6	46.6	70	0	10	2	1084.63	5
M75x1.5	50.0	56.0	56.0	63.0	59.7	57.9	80	0	11	2	1084.75	1
M80x2.0	-	-	58.0	65.0	62.0	59.8	95	0	12	1+2	1084.80.650	1
M85x2.0	-	-	63.0	70.0	67.0	64.7	95	0	12	1+2	1084.85.700	1

1 = Einteiliger Dichteinsatz

1 = One-piece sealing insert

Auf Anfrage lieferbar:

Available on request:

Erhältlich mit Dichteinsatz gemäss EN 45545. Bei Anfragen oder Bestellung bitte ein F vor die Artikelnummer setzen.

Available with sealing inserts conformity with EN 45545. When placing an inquiry, prefix the article number by the capital F.

Rostfreier Stahl A2 oder A4

Stainless steel A2 or A4

Anschlussgewinde Pg und NPT

Entry thread Pg and NPT

Kabelverschraubungen Progress® EMV powerCONNECT Messing

Cable glands Progress® EMC powerCONNECT nickel-plated brass

Langes Anschlussgewinde metrisch | Filet de raccordement métrique long

Material: Messing vernickelt
 Dichtung: TPE
 O-Ring: NBR
 Zugentlastung: Ausführung A nach EN 62444
 Einsatztemperatur: -60°C / +100°C
 Schutzart: IP 68 (bis 10 bar)
 Weitere Schutzart: IP 69
 Eigenschaften: Für hohe Ableitströme, konzentrische Schirmkontaktierung 360° mit tiefstem Übergangswiderstand und Transferimpedanz. Sehr geringe Bauhöhe.

Material: Nickel-plated brass
 Seal: TPE
 O-ring: NBR
 Strain relief: Version A acc. to EN 62444
 Temperature range: -60°C / +100°C
 Protection class: IP 68 (up to 10 bar)
 Further protection: IP 69
 Properties: For high leakage currents, concentric 360° shield contact ensure extremely low transfer resistance and transfer impedance. Compact design.

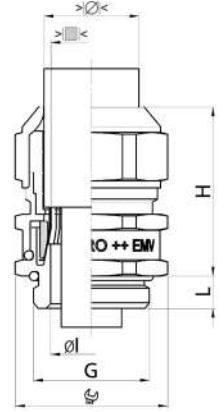

Zweiteiliger Dichteinsatz
 nicht durchgehend isolierend
 2 = Zulassungen in Vorbereitung

Two-piece sealing insert
 not overall length insulated
 2 = Approvals in preparation

G	>Ø< min mm	>Ø< max mm	>Ø< min mm	>Ø< max mm	>■< mm	ØI mm	mm	H mm	L mm	i info	Art.-Nr. Art. No.	
M16x1.5	6.0	8.0	8.0	10.5	9.3	8.2	18	0	10	2	1184.17	25
M20x1.5	8.0	11.0	11.0	15.0	13.4	11.9	24	0	10	2	1184.20	25
M25x1.5	12.5	16.0	16.0	20.5	18.7	17.6	30	0	11	2	1184.25	25
M32x1.5	17.0	21.0	21.0	25.5	23.8	22.1	36	0	13	2	1184.32	25
M40x1.5	24.0	28.5	28.5	33.0	30.4	29.5	46	0	13	2	1184.40	10
M50x1.5	33.0	37.0	37.0	42.0	38.7	37.7	55	0	14	2	1184.50	10
M63x1.5	40.0	46.0	52.0	46.0	48.6	46.6	70	0	14	2	1184.63	5
M75x1.5	50.0	56.0	56.0	63.0	59.7	57.9	80	0	15	2	1184.75	1
M80x2.0	-	-	58.0	65.0	62.0	59.8	95	0	18	1+2	1184.80.650	1
M85x2.0	-	-	63.0	70.0	67.0	64.7	95	0	18	1+2	1184.85.700	1

1 = Einteiliger Dichteinsatz

1 = One-piece sealing insert

Auf Anfrage lieferbar:

Available on request:

Erhältlich mit Dichteinsatz gemäss EN 45545. Bei Anfragen oder Bestellung bitte ein F vor die Artikelnummer setzen.

Available with sealing inserts conformity with EN 45545. When placing an inquiry, prefix the article number by the capital F.

Rostfreier Stahl A2 oder A4

Stainless steel A2 or A4

Anschlussgewinde Pg und NPT

Entry thread Pg and NPT



Kabelverschraubungen Progress® EMV Serie 85 Messing mit Spannzange

Cable glands Progress® EMC Series 85 nickel-plated brass with collet chuck

Anschlussgewinde metrisch | Entry thread metric

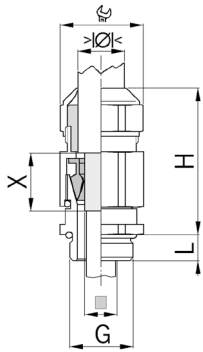

Material: Messing vernickelt
 Dichtung: TPE
 O-Ring: NBR
 Zugentlastung: Ausführung A nach EN 62444
 Einsatztemperatur: -40°C / +100°C
 Schutzart: IP 68 (bis 10 bar)
 Weitere Schutzart: IP 69
 Eigenschaften: Für hohe Ableitströme, konzentrische Schirmkontaktierung mit tiefsten Übergangswiderständen und Transferimpedanzen

Material: Nickel-plated brass
 Seal: TPE
 O-ring: NBR
 Strain relief: Version A acc. to EN 62444
 Temperature range: -40°C / +100°C
 Protection class: IP 68 (up to 10 bar)
 Further protection: IP 69
 Properties: For high leakage currents, concentric shield contact with minimal transfer resistances and transfer impedances

Progress MS EMV Serie 85



Zweiteiliger Dichteinsatz nicht durchgehend isolierend

Two-piece sealing insert not overall length insulated

G	> Ø < min mm	> Ø < max mm	> Ø < min mm	> Ø < max mm	> ■ < mm	mm	H mm	L mm	X mm	Art.-Nr. Art. No.	
M16x1.5	-	-	4.5	6.0	3.0-4.5	18	40	6	14	1000.17.85.045	25
M16x1.5	6.0	8.0	8.0	10.5	4.5-8.0	18	42	8	16	1000.17.85.080	25
M16x1.5	8.0	11.0	11.0	15.0	7.5-10.0	24	47	8	20	1000.17.85.100	25
M20x1.5	8.0	11.0	11.0	15.0	7.5-12.0	24	47	8	20	1000.20.85.120	25
M20x1.5	12.5	16.0	16.0	20.5	10.0-14.0	30	59	8	21	1000.20.85.140	20
M25x1.5	12.5	16.0	16.0	20.5	10.0-16.0	30	59	8	21	1000.25.85.160	20
M25x1.5	17.0	21.0	21.0	25.5	14.0-19.0	36	66	8	24	1000.25.85.190	25
M32x1.5	17.0	21.0	21.0	25.5	14.0-22.0	36	66	10	24	1000.32.85.220	25
M32x1.5	24.0	28.5	28.5	33.0	21.0-25.0	46	68	10	24	1000.32.85.250	5
M40x1.5	24.0	28.5	28.5	33.0	21.0-30.0	46	68	12	24	1000.40.85.300	5
M50x1.5	33.0	37.0	37.0	42.0	29.0-38.0	55	82	13	30	1000.50.85.380	5
M63x1.5	33.0	37.0	37.0	42.0	29.0-38.0	70/55	82	15	30	1000.63.85.380	5
M63x1.5	40.0	46.0	46.0	52.0	35.0-44.0	70	78	15	26	1000.63.85.440	1

Erhältlich mit Dichteinsatz gemäss EN 45545. Bei Anfragen oder Bestellung bitte ein F vor die Artikelnummer setzen.

Available with sealing inserts conformity with EN 45545. When placing an inquiry, prefix the article number by the capital F.

Wichtig!

Important!

Um den Kabelschirm und die Kabellitzen optimal zu schützen ist es erforderlich, das der Kabelverschraubung beiliegende Kupfer-EMV-Tape zu montieren.

To provide the best possible protection for the cable shield and the cable, it is necessary to install a copper EMC tape.

Das Kupfer-Tape muss zwingend gemäß Illustration montiert werden! (Beispiel: Tape Scotch 3M Typ 1181)

The copper tape must be fixed according to the illustration! (example: Tape Scotch 3M Typ 1181)

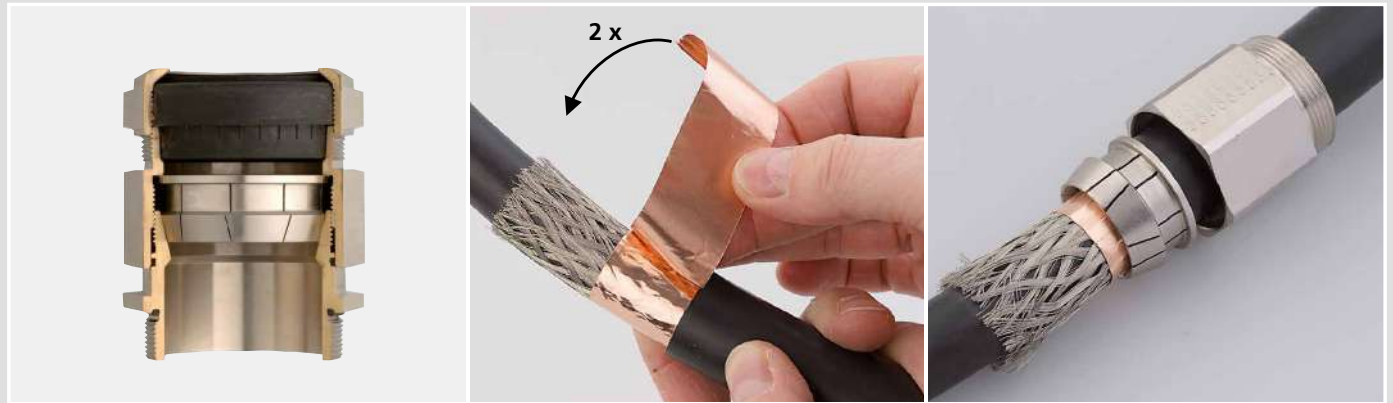

Kabelverschraubungen Progress® EMV Serie 85 Messing mit Spannzange

Cable glands Progress® EMC Series 85 nickel-plated brass with collet chuck

Anschlussgewinde Pg | Entry thread Pg

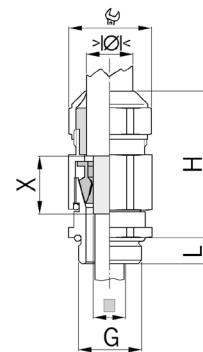

Material: Messing vernickelt
 Dichtung: TPE
 O-Ring: NBR
 Einsatztemperatur: -40°C / +100°C
 Schutzart: IP 68 (bis 10 bar)
 Weitere Schutzart: IP 69
 Eigenschaften: Für hohe Ableitströme, konzentrische Schirmkontaktierung mit tiefsten Übergangswiderständen und Transferimpedanzen

Material: Nickel-plated brass
 Seal: TPE
 O-ring: NBR
 Temperature range: -40°C / +100°C
 Protection class: IP 68 (up to 10 bar)
 Further protection: IP 69
 Properties: For high leakage currents, concentric shield contact with minimal transfer resistances and transfer impedances



Zweiteiliger Dichteinsatz
 nicht durchgehend isolierend

Two-piece sealing insert
 not overall length insulated

G	> Ø < min mm	> Ø < max mm	> Ø < min mm	> Ø < max mm	> ■ < mm	 mm	H mm	L mm	X mm	Art.-Nr. Art. No.	
Pg 11	6.0	8.0	8.0	10.5	4.5-8.0	21/18	42	8	16	1000.11.85.080	25
Pg 11	8.0	11.0	11.0	15.0	7.5-12.0	24	47	8	20	1000.11.85.120	25
Pg 16	8.0	11.0	11.0	15.0	7.5-12.0	24	47	8	20	1000.16.85.120	25
Pg 16	12.5	16.0	16.0	20.5	10.0-15.0	30	59	8	21	1000.16.85.150	25
Pg 21	12.5	16.0	16.0	20.5	10.0-16.0	30	59	8	21	1000.21.85.160	20
Pg 21	17.0	21.0	21.0	25.5	14.0-19.0	36	66	8	24	1000.21.85.190	25
Pg 29	17.0	21.0	21.0	25.5	14.0-22.0	38/36	66	10	24	1000.29.85.220	20
Pg 29	24.0	28.5	28.5	33.0	21.0-25.0	46	68	10	24	1000.29.85.250	5



Erhältlich mit Dichteinsatz gemäss EN 45545. Bei Anfragen oder Bestellung bitte ein F vor die Artikelnummer setzen.

Available with sealing inserts conformity with EN 45545. When placing an inquiry, prefix the article number by the capital F.

Wichtig!

Important!

Um den Kabelschirm und die Kabellitzen optimal zu schützen ist es erforderlich, das der Kabelverschraubung beiliegende Kupfer-EMV-Tape zu montieren.

To provide the best possible protection for the cable shield and the cable, it is necessary to install a copper EMC tape.

Weitere Abmessungen auf Anfrage

Further dimensions upon request

Das Kupfer-Tape muss zwingend gemäß Illustration montiert werden! (Beispiel: Tape Scotch 3M Typ 1181)

The copper tape must be fixed according to the illustration! (example: Tape Scotch 3M Typ 1181)

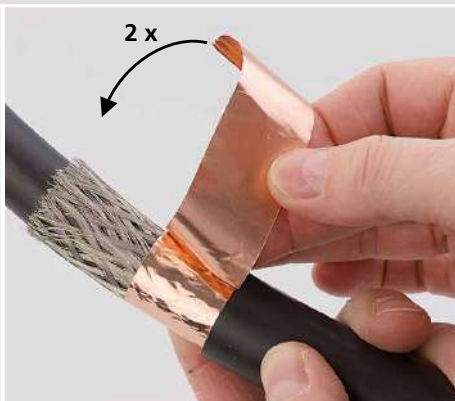

Zubehör zu EMV-Kabelverschraubungen

EMC cable glands accessories

Anschlussgewinde metrisch | Entry thread metric

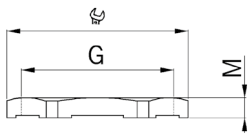



EMV-Gegenmuttern Messing mit Schneidezähnen

Material: Messing vernickelt
 Ausführung: EMV-Gegenmutter Messing mit Schneidezähnen für eine optimale Kontaktierung
 Einsatztemperatur: -60°C / +200°C

EMC lock nuts nickel-plated brass with cutter teeth

Material: Nickel-plated brass
 Execution: EMC lock nut brass with cutting teeth for optimised shield contact
 Temperature range: -60°C / +200°C





G	 mm	M mm	i info	Art.-Nr. Art. No.	
M8x1.25	11	3.3	1	8008.85	25
M10x1.5	13	3.3	1	8010.85	25
M12x1.5	15	3.5	-	8012.85	25
M16x1.5	19	3.5	-	8017.85	25
M20x1.5	24	4.0	-	8020.85	25
M25x1.5	30	4.0	-	8025.85	10
M32x1.5	36	5.0	-	8032.85	10
M40x1.5	46	5.3	-	8040.85	10
M50x1.5	55	6.3	-	8050.85	10
M63x1.5	70	7.0	-	8063.85	10

1 = Metrisches Regelgewinde 1 = Metric coarse-pitch thread

Anschlussgewinde Pg | Entry thread Pg



G	 mm	M mm	Art.-Nr. Art. No.	
Pg 7	15	3.3	8007.85	25
Pg 9	18	3.3	8009.85	25
Pg 11	21	3.5	8011.85	25
Pg 13	24	3.5	8013.85	25
Pg 16	26	3.5	8016.85	25
Pg 21	32	4.0	8021.85	10
Pg 29	41	4.6	8029.85	10
Pg 36	50	5.8	8036.85	10
Pg 42	60	5.8	8042.85	10
Pg 48	65	6.5	8048.85	10

passend zu Kabelverschraubungen Progress® | suitable for cable glands Progress®

Erdungslaschen zu Kabelverschraubungen Grounding straps suitable for cable glands

Material: Messing roh
 Einsatztemperatur: -60°C / +200°C
 Einsatzbereich: Löt- oder steckbar
 6,3 x 1,0 mm

Material: Brass raw
 Temperature range: -60°C / +200°C
 Application: Solderable or pluggable
 6,3 x 1,0 mm

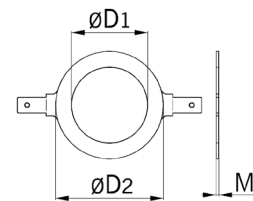

Erdungslaschen zu Kabelverschraubungen Anschlussgewinde metrisch				Grounding straps suitable for cable glands Entry thread metric	
G	ØD1 mm	ØD2 mm	M mm	Art.-Nr. Art. No.	
M12 / Pg 7	13.0	24	1	1007.80.10	100
M16 / Pg 9	16.5	24	1	1017.80.10	100
M20 / Pg 13	20.7	28	1	1020.80.10	100
M25	25.5	32	1	1025.80.10	100
M32	33.0	40	1	1032.80.10	100
M40	40.5	52	1	1040.80.10	100
M50	50.5	62	1	1050.80.10	50
M63	63.5	78	1	1063.80.10	50



Erdungslaschen zu Kabelverschraubungen Anschlussgewinde Pg				Grounding straps suitable for cable glands Entry thread Pg	
G	ØD1 mm	ØD2 mm	M mm	Art.-Nr. Art. No.	
M12 / Pg 7	13.0	24	1	1007.80.10	100
M16 / Pg 9	16.5	24	1	1017.80.10	100
Pg 11	19.0	28	1	1011.80.10	100
M20 / Pg 13	20.7	28	1	1020.80.10	100
Pg 16	23.0	32	1	1016.80.10	100
Pg 21	29.0	37	1	1021.80.10	100
Pg 29	38.0	52	1	1029.80.10	50
Pg 36	48.0	62	1	1036.80.10	50



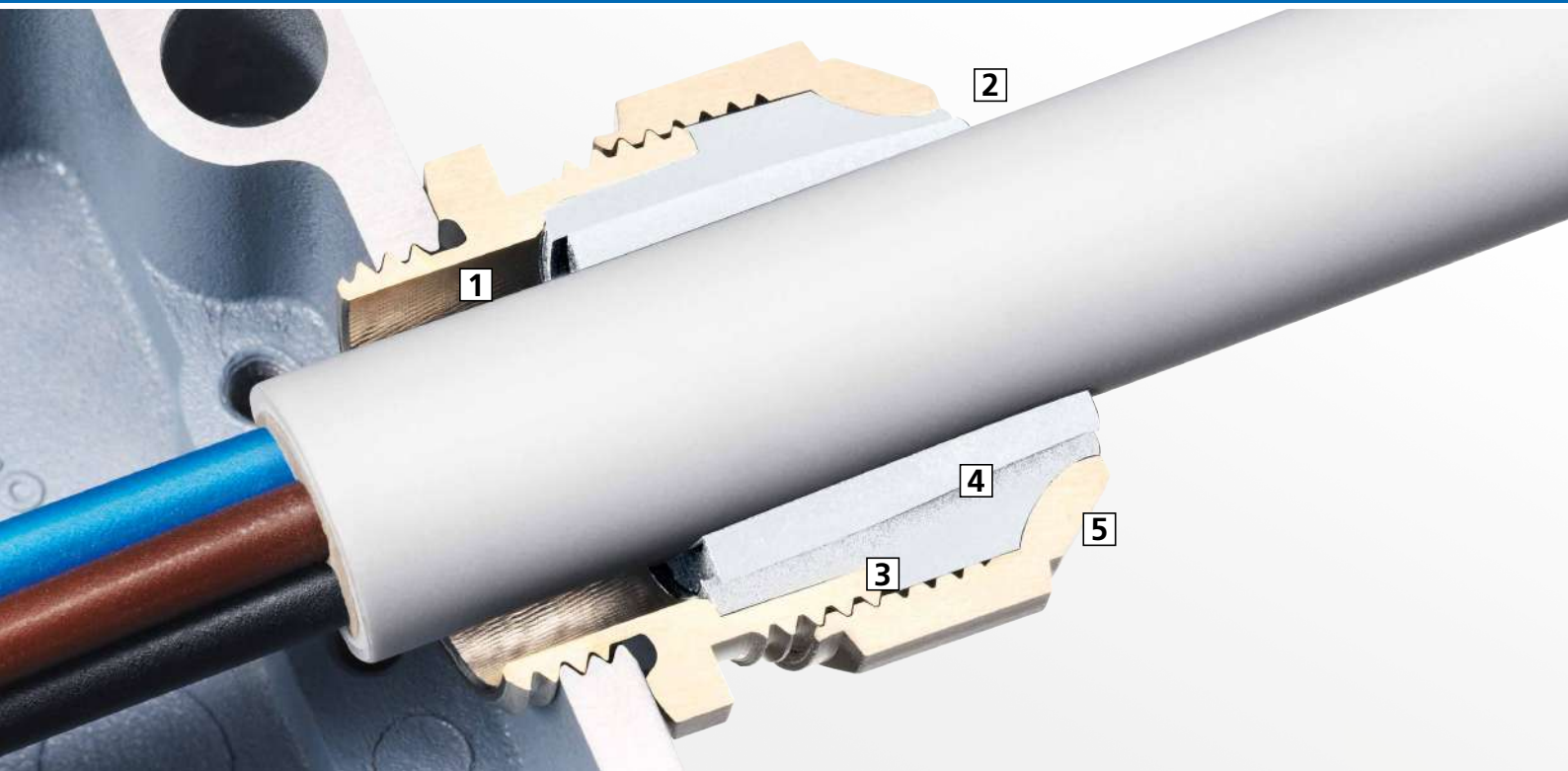

AGRO Kabelverschraubungen Progress® in Metall für den Einsatz in Schienenfahrzeugen

AGRO Progress® Kabelverschraubungen aus Metall können mit Dichteinsätzen aus einem speziellem TPE bestückt werden. In dieser Ausführung sind sie zertifiziert nach EN 45545 sowie NFPA 130 und können bedenkenlos für alle Anwendungen und Anordnungen im Schienenfahrzeugbau eingesetzt werden.

1 Kurze, lange oder Spezial-Anschlussgewinde

Kabelverschraubungen Progress® mit kurzem oder langem Anschlussgewinde in metrischer oder Ausführung können bei vorhandenem Öffnungsgewinde oder mit Gegenmutter verwendet werden.

2 Sichtbare Sicherheit

Der kleine Wulst des Dichteinsatzes bestätigt das richtige Anzugsdrehmoment.

3 Hoher Verdrehschutz

Die im Unterteil integrierte Längsrandrierung sorgt über den Dichteinsatz für eine hohe Verdrehsicherheit.

4 Kompressionstechnik

Die ein- oder zweiteiligen Dichteinsätze werden durch die Druckmutter verpresst und eine ausserordentlich Kabel schonende Zugentlastung wird erreicht. Der Kabelmantel bleibt selbst bei dynamischen Anwendungen langfristig intakt.

5 Garantierte Dichtigkeit

Auf den Dichteinsatz abgestimmte Innenkonturen sorgen für eine zielgerichtete Verformung des Dichteinsatzes und garantieren somit dessen perfekte Abdichtung. Die Schutzart IP 68 bis 10 bar sowie IP 69 ermöglichen eine breite Anwendung.

AGRO metal cable glands Progress® for rolling stock applications

AGRO Progress® metal cable glands can be equipped with sealing inserts made of a special TPE. These versions are certified according to EN 45545 and NFPA 130 and can be used with confidence for any rolling stock application.

1 Short, long or special entry thread

Cable glands Progress® with short or long entry thread designed as metric or Pg can be used with existing opening threads or with a counter nut.

2 Visible safety

The small bulge in the sealing insert confirms the correct tightening torque.

3 High distortion protection

The integrated retaining grooves in the lower part and in the sealing insert grant against twisting.

4 Compression technology

The one or two-part sealing inserts are being compressed by a compression nut. A very cable-protecting strain relief is produced. The cable jacket will not be harmed, even on the occasion of long-term dynamic stress.

5 Guaranteed seal

Inner contours matched to the sealing insert ensure a targeted deformation of the insert and thus guarantee its tightness in compliance with protection class IP 68 up to 10 bar and IP 69 for a wide range of applications.



Kabelverschraubungen Progress® Metall nach EN 45545 und NFPA 130
 Cable glands Progress® metal according to EN 45545 and NFPA 130



110 - 111

- Progress® Messing
Progress® nickel-plated brass
- Standard
Standard
- EMV Kabelverschraubungen
EMC cable glands
- Kombi-Schlauchverschraubungen
Combination conduit glands
- Winkel
Elbows
- für mehrere Kabel
for installation of multiple cables
- mit Dichteinsatz ohne Bohrung
with sealing insert without drilled hole
- für spezielle Kabel
for special cables
- mit Knickschutzfeder
with antikink spring
- mit Trompete und / oder Klemmbacken
with trumpet and / or clamps

Ausführung / Version	Progress® Messing Progress® nickel-plated brass	Standard Standard	EMV Kabelverschraubungen EMC cable glands	Kombi-Schlauchverschraubungen Combination conduit glands	Winkel Elbows	für mehrere Kabel for installation of multiple cables	mit Dichteinsatz ohne Bohrung with sealing insert without drilled hole	für spezielle Kabel for special cables	mit Knickschutzfeder with antikink spring	mit Trompete und / oder Klemmbacken with trumpet and / or clamps
Kompressionstechnik Compression technology	•	•	•	•	•	•	•	•	•	•
Gewinde / Thread										
Anschlussgewinde metrisch Entry thread metric	•	•	•	•	•	•	•	•	•	•
Anschlussgewinde Pg Entry thread Pg	•	•	•	•	•	•	•	•	•	•
Kurzes Anschlussgewinde (Standard) Short entry thread (standard)	•	•	•	•	•	•	•	•	•	•
Langes Anschlussgewinde Long entry thread	•	•	•	•	•	•	•	•	•	•
Sondergewinde (extra lang, Innengewinde) Special thread (extra long, internal thread)	•	-	-	-	-	-	-	-	-	-
Dichteinsatz / Sealing insert										
Für Rundkabel For round cables	•	•	•	•	•	-	-	•	•	•
Für Flachkabel For flat cables	•	-	-	-	-	-	•	-	-	-
Für mehrere Kabel (Multi-Dichteinsatz) For several cables	•	•	-	-	•	-	-	-	-	-
Vollgummi-Dichteinsatz Solid rubber sealing insert	•	•	-	-	-	•	-	-	-	-
Einteiliger Dichteinsatz One-piece sealing insert	•	•	-	-	•	•	•	•	-	-
Zweiteiliger Dichteinsatz Two-piece sealing insert	•	•	•	•	-	-	-	•	•	•
Technische Besonderheiten / Technical features										
Vibrationsschutz Vibration resistance	•	•	•	•	•	•	•	•	•	•
Material / Material										
Messing vernickelt Nickel-plated brass	•	•	•	•	•	•	•	•	•	•
Rostfreier Stahl A2 Stainless steel A2	•	-	-	-	•	•	•	-	-	-

1
2
3
4
5
6
7
8
9
10
11
12

AGRO Kabelverschraubungen Progress® nach EN 45545-2 und NFPA 130

AGRO Cable glands Progress® according to EN 45545-2 and NFPA 130



Beste Resultate bei Prüfungen nach EN 45545-2 (Komponenten)

Die Dichteinsätze der Progress® Kabelverschraubung sind aus einem speziellen TPE gefertigt und sind im anspruchsvollsten **Hazard Level 3 (R22/R23) zertifiziert**.

Die geforderten Werte für Hazard Level 3 wurden sowohl im Ausen- als auch im Innenbereich deutlich übertroffen:

Best results in testing according to EN 45545-2 (Components)

The seal inserts of Progress® cable glands are made of a special TPE and **certified to the demanding Hazard Level 3 (R22/R23)**.

The stipulated values for Hazard Level 3 were exceeded, for both indoor and outdoor areas

	Normwert für HL 3 aussen Requirement for HL 3 outdoor	Normwert für HL 3 innen Requirement for HL 3 indoor	AGRO Resultat AGRO result
Sauerstoffindex Oxygen index	Min. 32%	Min. 32%	39%
Rauchgasdichte Ds Smoke gas density Ds	Max. 300	Max. 150	110
Toxizität CIT Toxicity CIT	Max. 1.5	Max. 0.75	0.16

Vorgaben der EN 45545-3 übertroffen!

Ziel der **EN 45545-3** ist es, die Brandausbreitung durch Materialanforderungen zu begrenzen. Wenn Kabel durch Feuerschutzabschlüsse geführt werden, gelten diese Anforderungen auch für Kabelverschraubungen.

AGRO Progress® Kabelverschraubungen aus Metall übertreffen die Vorgaben der **EN 45545-3** bei weitem und erreichen die sehr hohe Feuerwiderstandsklasse **E30**. Die Dichteinsätze sind mindestens 30 Minuten lang dicht und verhindern einen Flammenübertrag auf die dem Feuer abgewandte Seite und es bilden sich keine Spalten. Sie können aus brandschutztechnischer Sicht bedenkenlos in allen Schienenfahrzeugen eingesetzt werden.

Exceeding the demands of EN 45545-3!

The aim of **EN 45545-3** is to limit fire spread by specifying the performance of materials and components. If cables are directed through fire barriers, the requirements apply also to the cable glands used.

AGRO Progress® metal cable glands easily exceed the requirements of EN 45545-3 and satisfy the very high demands of fire resistance class **E30**. This means that the seal inserts remain impervious and prevent the spread of fire through the gland for at least 30 minutes. They do not crack or fissure. From a fire protection perspective, they can be used without hesitation in all railway vehicles.

	Einbaulage vertikal Vertical installation	Einbaulage horizontal Horizontal installation	Klassierung Classification
AGRO Resultat AGRO Result	44 min	41 min	E30

AGRO Kabelverschraubungen Progress® nach EN 45545 und NFPA 130

AGRO Cable glands Progress® according to EN 45545 and NPFA 130

Lange und kurze Anschlussgewinde metrisch | Long and short entry threads metric, Pg

Material: Messing vernickelt
Material Dichteinsatz: Spezial AGRO TPE
Farbe Dichteinsatz: Hellgrau RAL 7035
Gewinde: M12 bis M63
Pg 7 bis Pg48
Einsatztemperatur -50°C / +105°C
Schutzart IP 68 / IP 69
Weitere Normen: EN 62444

Material: Nickel-plated brass
Material sealing insert: Special AGRO TPE
Colour sealing insert: RAL 7035
Threads: M12 M63
Pg 7 Pg48
Temperature range: -50°C / +105°C
Protection class: IP 68 / IP 69
Norms: EN 62444



Alle Kabelverschraubungen, welche mit Dichteinsätzen für Bahnapplikationen gemäss EN 45545 und NFPA 130 erhältlich sind, sind im Katalog mit einem entsprechenden Vermerk gekennzeichnet.

Suchen Sie im Katalog oder auf der Website die Standard-Kabelverschraubung mit dem gewünschten Klemmbereich und dem benötigten Gewinde. Stellen Sie der betreffenden Artikel Nummer den Grossbuchstaben „F“ voran und sie werden die Variante mit Dichteinsatz in Spezial TPE erhalten.

Eine Kabelverschraubung M20 mit einem langen metrischen Anschlussgewinde und einem Klemmbereich von 8.0 - 14.5 mm erhält die Artikel Nummer F1160.20. Zur Vereinfachung benutzen Sie den Produktfinder auf unserer Website www.agro.ch.

All cable glands, which are available with sealing inserts for railway applications according to EN 45545 and NFPA 130 are marked in the catalogue with an appropriate note.

Search the standard cable gland with the desired clamping range as well as with the required entry thread in our catalogue or on the website. When placing an order or inquiry, prefix the article number by the capital "F" and you will get the version with sealing insert made of special TPE.

A cable gland M20 with a long metric entry thread and a clamping range of 8.0 - 14.5 mm gets the item number F1160.20. The Product Finder on our website www.agro.ch simplifies your research.

AGRO Cable Glands

Navigation path →

OVERVIEW

PRODUCT SEARCH

Type of installation (2)

ALL ▼

Material (1)

Nickel-plated brass ▼

Thread (1)

M20x1.5 ▼

Minimum operation temperature (4)

ALL ▼

Maximum operation temperature (4)

ALL ▼

Cable diameter (mm)

14 ▼

63 Products

RESET FILTER

ProduktProduct

Artikelnummer-
Article number



Cable gland Progress® nickel-plated brass

Thread: M20x1.5
 minimum clamping range: 8.0
 maximum clamping range: 14.5

F 1160.20

NOTE

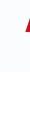

Ex Kabelverschraubungen

Ex cable glands

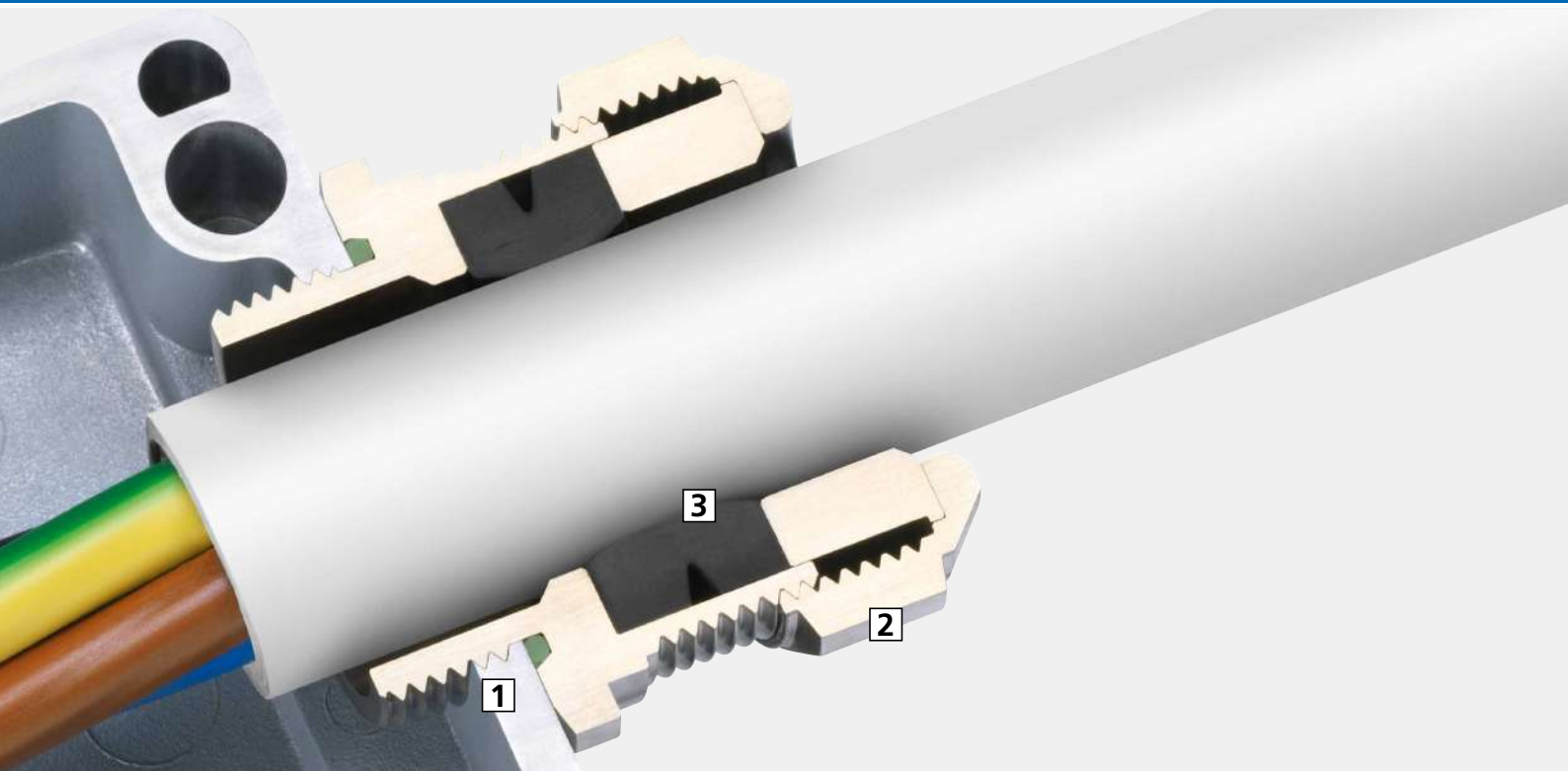

In vielen Bereichen wie zum Beispiel der Chemischen Industrie, Lackierereien, Offshore, Raffinerien, Tankstellen, Textil- und Papierindustrie, Nahrungsmittelindustrie, Glas- und/oder Keramikindustrie, Holzverarbeitung und in vielen weiteren Industrien, werden Geräte in explosionsgefährdeten Bereichen betrieben. Aufgrund der hohen Gefährdung von Personen sowie Sachwerten im Falle einer Explosion gelten speziell in explosionsgefährdeten Bereichen besonders strenge rechtliche und technische Anforderungen. AGRO Ex-Kabelverschraubungen aus Messing oder Kunststoff erfüllen die strengsten Anforderungen und sorgen in explosionsgefährdeten Bereichen für eine sichere Kabeleinführung. Alle Kabelverschraubungen sind zertifiziert und haben eine entsprechende EU-Baumusterprüfbescheinigung. Durch die IECEx Zertifizierung ist ein weltweiter Einsatz möglich.

1 Kurze, lange oder Spezial-Anschlussgewinde

Ex Kabelverschraubungen Progress® mit kurzem oder langem Anschlussgewinde in metrischer, Pg-, Gasrohr oder NPT-Ausführung können bei vorhandenem Gewinde oder Durchgangsbohrung mit Gegenmutter verwendet werden.

2 Stabile Schlüsselflächen

Grosse, stabile Schlüsselflächen an der Druckmutter vereinfachen das Anziehen mit dem Montagewerkzeug.

3 Garantierte Dichtigkeit

Auf den Dichteinsatz abgestimmte Innenkonturen sorgen für eine zielgerichtete Verformung des Dichteinsatzes und garantieren somit dessen perfekte Abdichtung. Die Schutzart IP 68 bis 10 bar (druckfeste Kapselung 30 bar) sowie IP 69 ermöglichen eine breite Anwendung.

In many areas such as the chemical industry, paint shops, offshore refineries, petrol stations, the textile and paper industry, the food industry, glass and / or ceramics industry, wood processing and many other industries, equipment are operated in explosive areas. Due to the high risk to persons and property in case of an explosion, especially strict legal and technical requirements apply to explosive areas in particular. AGRO Ex cable glands made of brass or plastic comply with the strictest requirements and ensure safe cable entry in explosive areas. All cable glands are certified accordingly and come with an EC type-examination certificate. IECEx certification allows for worldwide use.

1 Short, long or special entry thread

Ex Cable glands Progress® with short or long entry thread designed as metric, Pg, gas-pipe or NPT can be used with existing opening threads or with a counter nut.















2 Stable spanner flats

Large, stable spanner flats on the nut simplify tightening using the assembly tool.

3 Guaranteed seal

Inner contours matched to the sealing insert ensure a targeted deformation of the insert and thus guarantee its tightness in compliance with protection class IP 68 up to 10 bar (flameproof enclosure 30 bar) and IP 69 for a wide range of applications.

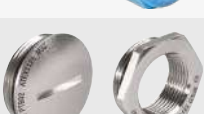

<p>Kabelverschraubungen Messing druckfeste Kapselung Ex d IIC Cable glands nickel-plated brass for flameproof enclosure Ex d IIC</p>		<p>119 - 121</p>	<p>1</p>
<p>Kabelverschraubungen Ex Compact Messing druckfeste Kapselung Ex d IIC / Ex e II Cable glands Ex Compact nickel-plated brass for flameproof enclosure Ex d IIC / Ex e II</p>		<p>122 - 124</p>	<p>2</p>
<p>Zubehör zu Kabelverschraubungen Messing druckfeste Kapselung Ex d IIC Cable gland accessoires nickel-plated brass for flameproof enclosure Ex d IIC</p>		<p>125 - 126</p>	<p>3</p>
<p>Kabelverschraubungen Progress® Messing erhöhte Sicherheit Ex e II Cable glands Progress® nickel-plated brass increased safety Ex e II</p>		<p>127 - 130</p>	<p>4</p>
<p>Kabelverschraubungen Progress® Messing für mehrere Kabel erhöhte Sicherheit Ex e II Cable glands Progress® nickel-plated brass for installation of multiple cables increased safety Ex e II</p>		<p>131 - 132</p>	<p>5</p>
<p>Kabelverschraubungen Progress® Messing mit Klemmbacken erhöhte Sicherheit Ex e II Cable glands Progress® nickel-plated brass with clamps increased safety Ex e II</p>		<p>133 - 134</p>	<p>6</p>
<p>Kabelverschraubungen Progress® Messing mit Trompete und Klemmbacken erhöhte Sicherheit Ex e II Cable glands Progress® nickel-plated brass with trumpet and clamps increased safety Ex e II</p>		<p>135 - 136</p>	<p>7</p>
<p>Kabelverschraubungen Progress® EMV Rapid Messing mit Kontaktscheibe, erhöhte Sicherheit Ex e II Cable glands Progress® EMC Rapid nickel-plated brass with contact disc increased safety Ex e II</p>		<p>137</p>	<p>8</p>
<p>Kabelverschraubungen Progress® EMV Messing mit Kontakthülse erhöhte Sicherheit Ex e II Cable glands Progress® EMC nickel-plated brass with contact sleeve increased safety Ex e II</p>		<p>138 - 139</p>	<p>9</p>
<p>Kabelverschraubungen Progress® EMV Messing mit Kontakthülse und Klemmbacken erhöhte Sicherheit Ex e II Cable glands Progress® EMC nickel-plated brass with contact sleeve and clamps increased safety Ex e II</p>		<p>140 - 141</p>	<p>10</p>
<p>Kombi-Schlauchverschraubung Progress® Messing erhöhte Sicherheit Ex e II Combination conduit glands Progress® nickel-plated brass increased safety Ex e II</p>		<p>142</p>	<p>11</p>
<p>Kabelverschraubungen Progress® Kunststoff GFK erhöhte Sicherheit Ex e II Synthetic cable glands Progress® GFK increased safety Ex e II</p>		<p>143 - 146</p>	<p>12</p>
<p>Kabelverschraubungen Progress® Kunststoff GFK für mehrere Kabel erhöhte Sicherheit Ex e II Synthetic cable glands Progress® GFK for installation of multiple cables increased safety Ex e II</p>		<p>147 - 148</p>	<p>13</p>
<p>Kabelverschraubungen Progress® Kunststoff GFK erhöhte Sicherheit Ex e II und Eigensicherheit Ex i IIC Synthetic cable glands Progress® GFK increased safety Ex e II and intrinsic safety Ex i IIC</p>		<p>149 - 150</p>	<p>14</p>
<p>Zubehör zu Kabelverschraubungen Messing und Kunststoff erhöhte Sicherheit Ex e II Cable gland accessoires nickel-plated brass and synthetic for increased safety Ex e II</p>		<p>151 - 157</p>	<p>15</p>

Richtlinien & Vorschriften

Richtlinie 2014/34/EU

Die Richtlinie 2014/34/EU des Europäischen Parlamentes und des Rates vom 26. Februar 2014 zur Harmonisierung der Rechtsvorschriften dient als Basis, welche für Hersteller und Benutzer von Geräten oder Schutzsystemen für den Einsatz in explosionsgefährdeten Bereichen verbindlich ist.

Seit dem 20.04.2016 dürfen nur noch Produkte gemäss den neuen Richtlinien und entsprechender EU-Konformitätserklärung auf den Markt gebracht werden. Die alten Zertifikate nach Richtlinie 94/9/EG behalten ihre Gültigkeit. Eine Neuzertifizierung nach den aktuellen Richtlinien 2014/34/EU ist nicht erforderlich.

Die Richtlinie 2014/34 EU definiert im Anhang verschiedene Module für die Inverkehrbringung von Geräten für den Einsatz in explosionsgefährdeten Bereichen. Oft verwendet, so auch bei AGRO, werden die Module B (Anhang III) und D (Anhang IV), woraus folgende Zertifikate resultieren:

- Die EU-Baumusterprüfbescheinigung
- Die Anerkennung Qualitätssicherung Produktion

Beide Zertifikate werden von akkreditierten Prüfstellen nach erfolgreich absolvierten Prüfungen/Audits ausgestellt.

EU-Baumusterprüfbescheinigung

Modul B regelt die EU-Baumusterprüfung. Darauf basiert die EU-Baumusterprüfbescheinigung. Sie wird auf Grund der erfolgreichen technischen Produkteprüfungen ausgestellt.

Anerkennung Qualitätssicherung Produktion

Modul D fordert die geprüfte und überwachte Produktion. Sie stellt sicher, dass die in Verkehr gebrachten Produkte mit den Prüfmustern der EU-Baumusterprüfbescheinigung übereinstimmen. Ein vorhandenes QM-System wird nach EN/ISO/IEC 80079-34 geprüft und zertifiziert.

EU-Konformitätserklärung

Die EU-Konformitätserklärung basiert auf der EU-Baumusterprüfbescheinigung und der Mitteilung Qualitätssicherung Produktion. Damit erklärt der Hersteller die Einhaltung der geltenden Normen, Richtlinien und Vorschriften. Sichtbar wird dies durch die CE-Kennzeichnung.

Installation



Für das Errichten und Betreiben sind die Vorschriften gemäss IEC / EN 60079-14, das Gerätesicherheitsgesetz, die allgemein anerkannten Regeln der Technik und die Betriebsanleitung massgebend. Damit der geforderte IP-Schutzgrad gemäss EN 60529:2014 erreicht wird, müssen die Verschraubungen sachgerecht im elektrischen Betriebsmittel eingebaut werden.

Bei Montage von Erweiterung oder Reduzierung ist darauf zu achten, dass maximal 1 Stk. eingebaut wird. Das Ineinanderschrauben mehrerer Reduktionen / Erweiterungen ist nach Norm nicht zulässig!

Bitte beachten Sie unbedingt unsere Montage-, Betriebs- und Wartungsanleitungen!

Beim Einsatz in Kunststoffgehäuse müssen die Kabelverschraubungen in den Potentialausgleich einbezogen werden. Die auf der Tabelle für die jeweiligen Grössen angegebenen Anzugsdrehmomente für die Druckmutter und die Klemmbackenschrauben sowie die ergänzenden Hinweise sind zu beachten.

Instandhaltung



Die für Wartung, Instandhaltung und Prüfung geltenden Bestimmungen der IEC / EN 60079-14 sind einzuhalten. Im Rahmen der Wartung sind vor allem die für die Zündschutzart massgebenden Teile zu prüfen.

Directives & Regulations

Directive 2014/34 EC

The directives 2014/34/EC of the European Parliament and of the Council of 26 February 2014 on the harmonisation of the laws of the Member States address manufacturers and users of equipment and protective systems for use in potentially explosive atmospheres.

Since 20 April 2016 only products approved according to the new directions and with EC declaration of conformity can be brought to the market. The old certificates according to the former directives 94/9/EC remain valid. A recertification according to the directives 2014/34/EU is not necessary.

In the annex of directives 2014/34 EC various modules for the commercialisation of equipment intended for use in potentially explosive atmospheres are defined. Modules III and IV are often used and applied at AGRO as well, and from them two certificates result:

- EC type-examination certificate
- Recognition of production quality assurance

Both certificates are issued by accredited testing facilities after tests have been successfully completed.

EC type-examination certificate

The EC type-examination certificate is the document which is issued on the base of successfully passed technical testing according to the requirements of module B.

Recognition of production quality assurance

Module D demands tested and monitored production. It ensures that products placed on the market are identical with the test samples used for the EC type-examination certificate. The quality management system must be tested and certified acc. to EN/ISO/IEC 80079-34.

CE declaration of conformity

The CE declaration of conformity is based on the EC type-examination certificate and QS approval. With it, a manufacturer declares that it has observed all applicable standards, instructions and regulations. This is made visible with the CE symbol, which is a part of the marking.

Installation



The regulations according to IEC / EN 60079-14, the equipment safety law, the generally acknowledged rules of the industry and these operating instructions are applicable for installation and operation. In order to ensure the required IP protection category according to EN 60529:1991 is achieved, the cable glands must be properly installed in the electrical equipment.

When installing enlarging or reduction fittings, make sure to install one piece only. The norm interdicts to screw several reduction / enlarging fittings into each other!

Please unconditionally take into account our assembly, instruction and maintenance guidelines.

When used in enclosures made of plastic, the cable glands must be included in the equipotential bonding system. The tightening torques stated in the table for the respective sizes of compression cap nuts and clamps and the additional information must be taken into account.

Maintenance



The provisions of IEC / EN 60079-14 which are applicable for service, maintenance and testing must be complied with. During maintenance, in particular the parts critical for the ignition protection category must be tested.

In Produktions- und Arbeitsstätten können sich Gefahrenbereiche für Explosionen ausbilden, wenn die ersten zwei Voraussetzungen für eine Explosion erfüllt sind. Typische Gefahrenbereiche entstehen in chemischen Fabriken, Raffinerien, Lackfabriken, Lackierereien, Reinigungsanlagen, Mühlen und Lagern für Mahlprodukte, Grossbäckereien und anderen brennbaren Stäuben, in Tank- und Verladeanlagen für brennbare Gase, Flüssigkeiten und Feststoffe.

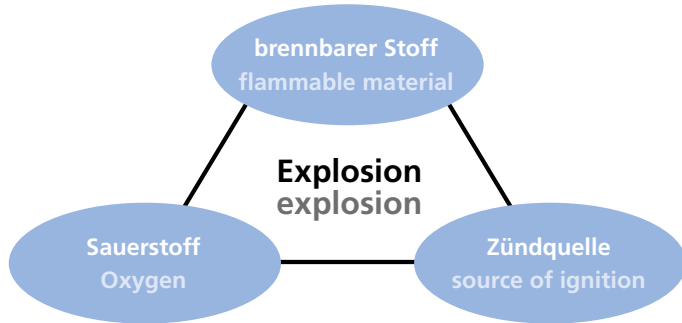

In production and work places, explosive areas may arise when the first two preconditions for an explosion are met. Typical danger zones are created in chemical factories, refineries, paint and varnish factories, paint shops, cleaning plants, mills and storehouses for mill products, large bakeries and other flammable dusts, in tank and loading facilities for inflammable gases, liquids and solid matter.

Beispiele für Zoneneinteilungen im Ex-Bereich

Examples for zone classifications in hazardous area

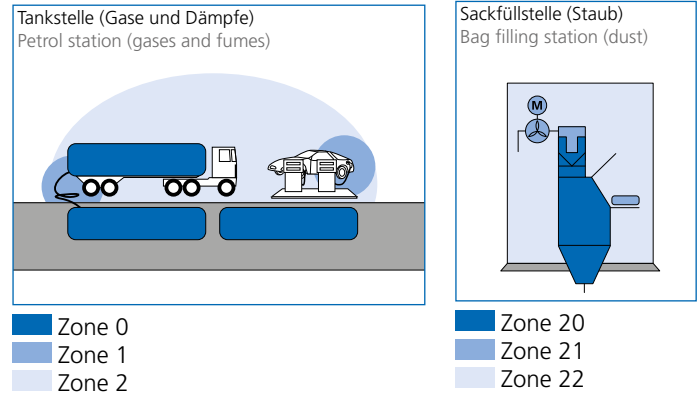

Weiterhin spielt für das Entstehen einer Explosion die Konstellation dieser Faktoren eine Rolle. So kann z.B. eine übersättigte Atmosphäre nicht zünden (Gemisch zu fett) ebenso eine Atmosphäre mit zu hohem Sauerstoffanteil (Gemisch zu mager).

Furthermore, for the appearance of an explosion, the constellation of these factors is important. If the atmosphere is saturated (rich mixture) it cannot ignite, also if the proportion of oxygen is too high (lean mixture).

Die Gerätekennzeichnung – unterschieden durch Buchstaben – sagt etwas über die explosionsfähigen Stoffe aus:

The marking of devices, varied by letters, gives information about the flammable material:

- M** vorangestellt steht für untertägige Bergwerke
- G** nachgestellt steht für brennbare Gase, Nebel oder Dämpfe und
- D** nachgestellt für Stäube

- M** mining
- G** flammable gas, fog, steam
- D** flammable dust

Ziffern drücken den Grad aus.

Figures express the level.

- 1** steht für ein sehr hohes Mass an Sicherheit
- 2** steht für ein hohes Mass an Sicherheit
- 3** steht für ein normales Mass an Sicherheit

- 1** very high degree of safety
- 2** high degree of safety
- 3** normal degree of safety

Damit ergibt sich die Zuordnung der Gerätekategorien zu den Zonen.

The outcome of this is the assignment of devices by zones.

Die Definition der Ex-Zonen und der Zusammenhang der explosionsgefährdeten Bereiche mit der Häufigkeit der Zündquellen im Übertagebetrieb.

The definition of the hazardous area and the combination between explosive areas and frequency by sources of ignition (no mining)

Zoneneinteilung / Zone classification						
	Gas / gas			Staub / dust		
	Zone 0	Zone 1	Zone 2	Zone 20	Zone 21	Zone 22
Häufigkeit der Explosionsgefahr	ständig oder langfristig	gelegentlich	selten und kurzfristig	wie Zone 0 Staubablagerungen allein bilden keine Zone 20	wie Zone 1	wie Zone 2 oder wenn Staubanhäufungen vorhanden sind
frequency of explosion risk	allways or long-term	casual	rare and for a short time	like zone 0 dust deposit alone is not generate zone 20	like zone 1	like zone 2 or if dust deposit occurs
Häufigkeit der Zündquellen von elektrischen Betriebsmitteln	niemals (auch nicht bei seltenen Betriebsstörungen)	sehr selten (auch nicht bei häufiger zu erwartenden Betriebsstörungen)	gelegentlich (z.B. bei Betriebsstörung)	wie Zone 0	wie Zone 1	wie Zone 2
frequency sources of ignition in electrical equipment	never (also not on rare breakdowns)	very rare (also not on frequently expected disturbances)	casual (e.g. on disturbances)	like zone 0	like zone 1	like zone 2

Generelle Informationen Explosionsschutz

Information about explosion protection

Gerätezuordnung nach Zonen Device assignment by zones			
Bereich Range	Stufe Explosionsgefahr Level explosion risk	Erforderliche Kennzeichnung der einsetzbaren Betriebsmittel Required marking of applicable equipment	
		Gerätegruppe* / Device*	Kategorie / Category
Gruppe II group II	Zone 0	II	1 G
Gruppe II group II	Zone 1	II	2 G oder / or 1 G
Gruppe II group II	Zone 2	II	3 G oder / or 2 G
Gruppe II group II	Zone 20	II	1 D
Gruppe II group II	Zone 21	II	2 D oder / or 1 D
Gruppe II group II	Zone 22	II	3 D oder wie / or like 2 D

* Die Geräte werden in zwei Gruppen unterteilt. Gruppe 1 gilt für schlagwettergefährdete Geräte zur Verwendung im Bergbau und wird hier nicht weiter beschrieben.
The equipment is divided into two groups. Group 1 is applicable to equipment at risk from firedamp and intended for use in mining and will not be describe further here.



Für elektrische Betriebsmittel der Gruppe II wird weiter eine Unterteilung in Explosionsgruppen und Temperaturklassen vorgenommen.

For electrical equipment of group II a further classification in explosion group and temperature classes has been taken.

Einteilung in Temperaturklassen Classification by temeratur class		
Zündtemperatur in °C Ignition temperature in °C	Temperaturklasse Temperature class	max. Oberflächentemperatur in °C des Betriebsmittels max. surface temperature in °C
≥ 450	T1	450
300-450	T2	300
200-300	T3	200
135-200	T4	135
100-135	T5	100
85-100	T6	85



Einteilung von Explosionsgruppen bei Gas- Ex-Schutz

Brennbare Gase/Dämpfe/Nebel unterscheiden sich in ihrem Zünddurchschlagsvermögen. Daher unterteilt man sie in Explosionsgruppen. Durch Versuchsreihen wurde hierbei die Grenzspaltweite MESG (Maximum Experimental Safe Gap) und der Mindestzündstrom MIC (Minimum Ignition Current) ermittelt. Die Gefährlichkeit der Gase nimmt hierbei von IIA nach IIC zu.

Classification of explosion groups for gas protection

Flamable gas/steam/fog differs in it's ignition breakdown capacity. Therefore they are classified in explosion groups. Test series showed the MESG (Maximum Experimental Safe Gap) and the MIC (Minimum Ignition Current) The risikness riscs from IIA to IIC.

Explosionsgruppe Explosions group	Grenzspaltwerte MESG Maximum experimental safe gap	Mindestzündstromverhältnis bezogen auf Methan Minimum ignition current relating to methane
II A	> 0.9 mm	> 0.8
II B	0.5 mm bis 0.9 mm	0.45 bis 0.8
II C	< 0.9 mm	< 0.45

Schematische Darstellung der Funktionsprinzipien von einzelnen Zündschutzarten für die AGRO Kabelverschraubungen anbietet

Schematical diagram of functional principle of some protection types, for which offers AGRO cable glands

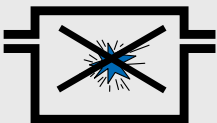
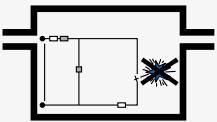
Zündschutzart nach IEC bzw. EN type of protection by IEC and/or EN	Grundprinzip basic principle	Schematische Darstellung schematic view
IEC / EN 60079-1	<p>Ex d druckfeste Kapselung Kommt es im Innern eines druckfest gekapselten Gehäuses zu einer Explosion wird eine Übertragung der Explosion nach aussen ausgeschlossen</p> <p>Ex d flameproof enclosures If an explosion occurs within a flameproof enclosure the escape to outside atmosphere will be prevented</p>	
IEC / EN 60079-7	<p>Ex e erhöhte Sicherheit Die Entstehung von Funken und hohen Temperaturen wird mit einem erhöhten Grad an Sicherheit ausgeschlossen</p> <p>Ex e increased safety The appearance of sparks ignitions and / or high temperatur is prevented by an increased level of security standard.</p>	
IEC / EN 60079-11	<p>Ex i Eigensicherheit Die Energie im Stromkreis wird so gering gehalten, dass zündfähige Funken, Lichtbögen oder hohe Temperaturen nicht entstehen können</p> <p>Ex i intrinsic safety The curcuit energy has to be kept under a certain level to prevent the appearance of ignitable sparks, electrical arcs and high temperature</p>	



Anwendungen

Die AGRO Kabelverschraubungen für explosionsgeschützte Geräte sind somit für die meisten Anwendungen an explosionsgeschützten Motoren, Schalt- und Steuergeräten, Gehäusen usw. geeignet, die in der Industrie, in der chemischen und petrochemischen Industrie eingesetzt werden.

Applications

The AGRO cable glands for explosion-protected equipment are therefore suitable for most of the applications in explosion-hazardous motors, switch and control gears, housings etc. used in industrial fields such as in the machinery and automation industry, in the chemical and petrochemical industry.



Kabelverschraubung Messing
Cable glands nickel-plated brass
druckfeste Kapselung (Serie 18)
flameproof enclosure (Serie 18)
druckfeste Kapselung (Serie 18)
flameproof enclosure (Serie 18)
Progress® Messing (Ex Compact)
Standard
für mehrere Kabel
for installation of multiple cables
mit Klemmbacken
with clamps
mit Trompete und Klemmbacken
with trumpet and clamps
EMV
EMC
Progress® Kunststoff (GFK)
Standard
für mehrere Kabel
for installation of multiple cables
Zubehör
Accessories
Reduktoren Messing
Reducers nickel-plated brass
Erweiterungen Messing
Expanders nickel-plated brass
Adapter Messing
Adapters nickel-plated brass
Verschlusschrauben
Locking screw

Ausführung / Version																	
Kompressionstechnik Compression technology		•	•		•	•	•	•	•		•	•		-	-	-	-
Zündschutzart Ignition protection categories		d	d		e	e	e	e	e		e/i	e/i		e	e	e	d/e
EMV Technik / EMC technology																	
Kontakthülse Contact sleeve		-	-		-	-	-	-	•		-	-		-	-	-	-
Kontaktscheibe Contact disc		-	-		-	-	-	-	•		-	-		-	-	-	-
Gewinde / Thread																	
Anschlussgewinde metrisch Entry thread metric		•	•		•	•	•	•	•		•	•		-	-	-	•
Anschlussgewinde Pg Entry thread Pg		•	-		•	•	•	•	•		•	•		-	-	-	•
Anschlussgewinde NPT Entry thread NPT		•	•		-	-	-	-	-		-	-		-	-	-	-
Anschlussgewinde Gasrohr Entry thread gas pipe		•	-		-	-	-	-	-		-	-		-	-	-	-
Aussengewinde metrisch - Innengewinde metrisch External thread metric - internal thread metric		-	-		-	-	-	-	-		-	-		•	•	-	-
Aussengewinde Pg - Innengewinde metrisch External thread Pg - internal thread metric		-	-		-	-	-	-	-		-	-		-	-	•	-
Kurzes Anschlussgewinde Short entry thread		-	-		•	•	•	•	•		•	•		•	•	•	•
Langes Anschlussgewinde Long entry thread		•	•		•	-	-	•	-		-	-		-	-	-	-
Dichteinsatz / Sealing insert																	
einteiliger Dichteinsatz One-piece sealing insert		•	•		•	•	-	-	•		•	•		-	-	-	-
zweiteiliger Dichteinsatz Two-piece sealing insert		-	-		-	-	•	•	-		-	-		-	-	-	-
für mehrere Kabel for installation of multiple cables		-	-		-	•	-	-	-		-	•		-	-	-	-
Standard-Dichteinsatz (TPE / NBR) Standard sealing insert (TPE/NBR)		•	•		•	•	•	•	•		•	•		-	-	-	-
Technische Besonderheiten / Technical features																	
Zugentlastung Strain relief		•	•		•	•	•	•	•		•	•		-	-	-	-
Vibrationsschutz Vibration resistance		•	•		•	•	•	•	•		•	•		-	-	-	-
mechanische Zugentlastung mechanical strain relief		•	•		-	-	•	-	•		-	-		-	-	-	-
mit Biegeschutz und mecha- nischer Zugentlastung with bending protection and mechanical strain relief		•	-		-	-	-	•	-		-	-		-	-	-	-

AGRO Ex Kabelverschraubungen Messing druckfeste Kapselung Ex d IIC

AGRO Ex cable glands nickel-plated brass for flameproof enclosure Ex d IIC

Anschlussgewinde metrisch | Entry thread metric

Material: Messing vernickelt
 Schrauben: Rostfreier Stahl A2
 Dichtung: NBR
 O-Ring: FPM
 Einsatztemperatur: -40°C / +100°C
 Schutzart: IP 68 (30 bar)
 Prüfnorm: IEC EN 60079-0 / IEC EN 60079-1 / IEC EN 60079-31
 Gas: II 2G Ex db eb IIC
 Staub: II 2D Ex ta IIIC
 Zone: Gas 1 und 2 / Staub 21 und 22
 Zertifikat: PTB 00 ATEX 1059
 IECEx Zertifikat: IECEx PTB 12.0056

Material: Nickel-plated brass
 Screws: Stainless steel A2
 Seal: NBR
 O-ring: FPM
 Temperature range: -40°C / +100°C
 Protection class: IP 68 (30 bar)
 Test standard: IEC EN 60079-0 / IEC EN 60079-1 / IEC EN 60079-31
 Gas: II 2G Ex db eb IIC
 Dust: II 2D Ex ta IIIC
 Zone: Gas 1 and 2 / dust 21 and 22
 Certificate: PTB 00 ATEX 1059
 IECEx Certificate: IECEx PTB 12.0056

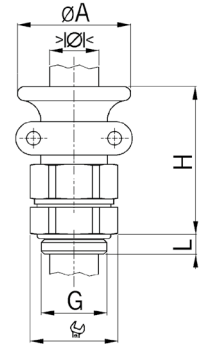

Serie 18



Einteiliger Dichteinsatz
 nicht durchgehend isolierend

One-piece sealing insert
 not overall length insulated

G	> Ø < min mm	> Ø < max mm	mm	ØA mm	H mm	L mm	Art.-Nr. Art. No.	
M16x1.5	7.0	9.0	20	27	57	12	1817.09.26	25
M20x1.5	9.0	11.0	24	30	57	12	1820.11.26	25
M20x1.5	11.0	13.0	26	32	57	14	1820.16.26	25
M25x1.5	13.0	16.5	32	40	67	16	1825.21.26	10
M25x1.5	16.5	20.0	36	44	67	16	1825.21.27	10
M32x1.5	20.0	24.0	46	48	78	17	1832.29.26	5
M40x1.5	24.0	28.0	46	52	78	17	1840.29.27	5
M50x1.5	28.0	32.0	55	60	85	17	1850.36.26	5
M50x1.5	32.0	36.0	55	64	85	17	1850.36.27	5
M63x1.5	36.0	40.0	70	75	88	20	1863.48.26	1
M63x1.5	40.0	44.0	70	80	88	20	1863.48.27	1



AGRO Ex Kabelverschraubungen Messing druckfeste Kapselung Ex d IIC

AGRO Ex cable glands nickel-plated brass for flameproof enclosure Ex d IIC

Anschlussgewinde Pg | Entry thread Pg

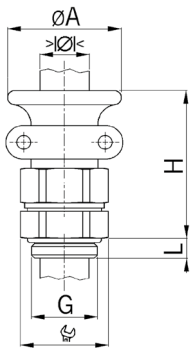

Material: Messing vernickelt
 Schrauben: Rostfreier Stahl A2
 Dichtung: NBR
 O-Ring: FPM
 Einsatztemperatur: -40°C / +100°C
 Schutzart: IP 68 (30 bar)
 Prüfnorm: IEC EN 60079-0 / IEC EN 60079-1 / IEC EN 60079-31
 Gas: II 2G Ex db eb IIC
 Staub: II 2D Ex ta IIIC
 Zone: Gas 1 und 2 / Staub 21 und 22
 Zertifikat: PTB 00 ATEX 1059
 IECEx Zertifikat: IECEx PTB 12.0056

Material: Nickel-plated brass
 Screws: Stainless steel A2
 Seal: NBR
 O-ring: FPM
 Temperature range: -40°C / +100°C
 Protection class: IP 68 (30 bar)
 Test standard: IEC EN 60079-0 / IEC EN 60079-1 / IEC EN 60079-31
 Gas: II 2G Ex db eb IIC
 Dust: II 2D Ex ta IIIC
 Zone: Gas 1 and 2 / dust 21 and 22
 Certificate: PTB 00 ATEX 1059
 IECEx Certificate: IECEx PTB 12.0056

Serie 18



Einteiliger Dichteinsatz
 nicht durchgehend isolierend

One-piece sealing insert
 not overall length insulated

G	> Ø < min mm	> Ø < max mm	mm	ØA mm	H mm	L mm	Art.-Nr. Art. No.	
Pg 9	7.0	9.0	20	27	57	12	1809.26	25
Pg 11	9.0	11.0	24	30	57	12	1811.26	25
Pg 13	11.0	13.0	26	32	57	14	1813.26	25
Pg 16	11.0	13.0	26	32	57	14	1816.26	25
Pg 21	13.0	16.5	32	40	67	16	1821.26	10
Pg 21	16.5	20.0	36	44	67	16	1821.27	10
Pg 29	20.0	24.0	45	48	78	17	1829.26	5
Pg 29	24.0	28.0	45	52	78	17	1829.27	5
Pg 36	28.0	32.0	55	60	85	17	1836.26	5
Pg 36	32.0	36.0	55	64	85	17	1836.27	5
Pg 48	36.0	40.0	64	75	88	20	1848.48.26	1
Pg 48	40.0	44.0	64	80	88	20	1848.48.27	1

Anschlussgewinde Gasrohr | Gas-pipe entry thread

Serie 18



Einteiliger Dichteinsatz
 nicht durchgehend isolierend

One-piece sealing insert
 not overall length insulated

G	> Ø < min mm	> Ø < max mm	mm	ØA mm	H mm	L mm	Art.-Nr. Art. No.	
G 3/8"	7.0	9.0	20	27	57	12	183/8G.09.26	25
G 1/2"	9.0	11.0	24	30	57	14	181/2G.11.26	25
G 1/2"	11.0	13.0	26	32	57	14	181/2G.16.26	25
G 3/4"	13.0	16.5	32	40	67	16	183/4G.21.26	10
G 3/4"	16.5	20.0	36	44	67	16	183/4G.21.27	10
G 1"	20.0	24.0	45	48	78	17	181G.29.26	5
G 1 1/4"	24.0	28.0	45	52	78	17	1811/4G.29.27	5
G 1 1/2"	28.0	32.0	55	60	85	17	1811/2G.36.26	5
G 2"	36.0	40.0	64	75	88	20	1848.26	1
G 2"	40.0	44.0	64	80	88	20	1848.27	1

AGRO Ex Kabelverschraubungen Messing druckfeste Kapselung Ex d IIC

AGRO Ex cable glands nickel-plated brass for flameproof enclosure Ex d IIC

Anschlussgewinde NPT | Entry thread NPT

Material: Messing vernickelt
 Schrauben: Rostfreier Stahl A2
 Dichtung: NBR
 O-Ring: FPM
 Einsatztemperatur: -40°C / +100°C
 Schutzart: IP 68, wenn Anschlussgewinde abgedichtet
 Prüfnorm: IEC EN 60079-0 / IEC EN 60079-1 / IEC EN 60079-31
 Gas: II 2G Ex db eb IIC
 Staub: II 2D Ex ta IIIC
 Zone: Gas 1 und 2 / Staub 21 und 22
 Zertifikat: PTB 00 ATEX 1059
 IECEx Zertifikat: IECEx PTB 12.0056

Material: Nickel-plated brass
 Screws: Stainless steel A2
 Seal: NBR
 O-ring: FPM
 Temperature range: -40°C / +100°C
 Protection class: IP 68, if the entry thread is sealed
 Test standard: IEC EN 60079-0 / IEC EN 60079-1 / IEC EN 60079-31
 Gas: II 2G Ex db eb IIC
 Dust: II 2D Ex ta IIIC
 Zone: Gas 1 and 2 / dust 21 and 22
 Certificate: PTB 00 ATEX 1059
 IECEx Certificate: IECEx PTB 12.0056

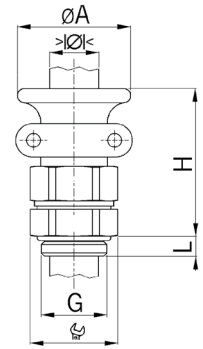

Serie 18



Einteiliger Dichteinsatz
 nicht durchgehend isolierend

One-piece sealing insert
 not overall length insulated

G	> Ø < min mm	> Ø < max mm	mm	ØA mm	H mm	L mm	Art.-Nr. Art. No.	
NPT 3/8"	7.0	9.0	20	27	57	15.5	183/8NPT.09.26	25
NPT 1/2"	9.0	11.0	24	30	57	20	181/2NPT.11.26	25
NPT 1/2"	11.0	13.0	26	32	57	20	181/2NPT.16.26	25
NPT 3/4"	9.0	11.0	27	30	57	20	183/4NPT.11.26	25
NPT 3/4"	11.0	13.0	26	32	57	20	183/4NPT.16.26	25
NPT 3/4"	13.0	16.5	32	40	67	20	183/4NPT.21.26	10
NPT 1"	13.0	16.5	32/34	40	67	25	181NPT.21.26	10
NPT 1"	16.5	20.0	36	44	67	25	181NPT.21.27	10
NPT 1 1/4"	20.0	24.0	45	48	78	26	1811/4NPT.29.26	5
NPT 1 1/4"	24.0	28.0	45	52	78	26	1811/4NPT.29.27	5
NPT 1 1/2"	28.0	32.0	55	60	85	26	1811/2NPT.36.26	5
NPT 1 1/2"	32.0	36.0	55	64	85	26	1811/2NPT.36.27	5



Anschlussgewinde metrisch | Entry thread metric

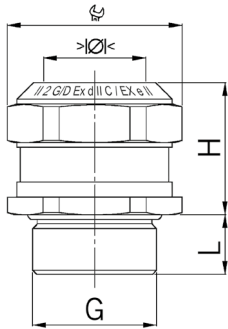

Material: Messing vernickelt
 Dichtung: NBR
 O-Ring: FPM
 Einsatztemperatur: -60°C / +105°C
 Schutzart: IP 68 (30 bar)
 Prüfnorm: IEC EN 60079-0 / IEC EN 60079-1 / IEC EN 60079-7 / IEC EN 60079-31
 Gas: II 2G Ex db eb IIC
 Staub: II 2D Ex ta IIIC
 Zone: Gas 1 und 2 / Staub 21 und 22
 Zertifikat: PTB 10 ATEX 1034X
 IECEx Zertifikat: IECEx PTB 12.0055X

Material: Nickel-plated brass
 Seal: NBR
 O-ring: FPM
 Temperature range: -60°C / +105°C
 Protection class: IP 68 (30 bar)
 Test standard: IEC EN 60079-0 / IEC EN 60079-1 / IEC EN 60079-7 / IEC EN 60079-31
 Gas: II 2G Ex db eb IIC
 Dust: II 2D Ex ta IIIC
 Zone: Gas 1 and 2 / dust 21 and 22
 Certificate: PTB 10 ATEX 1034X
 IECEx Certificate: IECEx PTB 12.0055X



EX Compact MS



Einteiliger Dichteinsatz
 nicht durchgehend isolierend

One-piece sealing insert
 not overall length insulated

G	> Ø < min mm	> Ø < max mm	Ø mm	H mm	L mm	Art.-Nr. Art. No.	
M16x1.5	3.0	7.0	21	26	12	EX1126.17.070	25
M16x1.5	5.0	10.0	24	26	12	EX1126.17.100	25
M20x1.5	5.0	11.0	24	26	12	EX1126.20.110	25
M20x1.5	9.0	14.0	30	26	12	EX1126.20.140	25
M25x1.5	7.5	15.0	32	28	12	EX1126.25.150	20
M25x1.5	12.5	18.0	32	28	12	EX1126.25.180	20
M32x1.5	17.0	23.0	41	33	12	EX1126.32.230	10
M32x1.5	21.0	26.0	41	33	12	EX1126.32.260	10
M40x1.5	21.0	26.0	41	33	14	EX1126.40.260	10
M40x1.5	24.0	32.0	50	34	14	EX1126.40.320	10
M50x1.5	28.0	36.0	55	34	14	EX1126.50.360	5
M50x1.5	35.0	42.0	60	35	14	EX1126.50.420	5
M63x1.5	36.0	44.0	65	35	14	EX1126.63.440	1
M63x1.5	43.0	50.0	70	35	14	EX1126.63.500	1

Auf Anfrage lieferbar:
 Ausführungen in Stahl A2 und A4

Available on request:
 Executions in steel A2 and A4

Anschlussgewinde metrisch | Entry thread metric

AGRO Kabelverschraubungen Ex Compact Messing mit Klemmbacken Ex d IIC und Ex e II **AGRO cable glands Ex Compact nickel-plated brass with clamps Ex d IIC and Ex e II**

Material: Messing vernickelt
 Dichtung: NBR
 O-Ring: FPM
 Einsatztemperatur: -60°C / +105°C
 Schutzart: IP 68 (30 bar)
 Prüfnorm: IEC EN 60079-0 / IEC EN 60079-1 / IEC EN 60079-7 / IEC EN 60079-31

Material: Nickel-plated brass
 Seal: NBR
 O-ring: FPM
 Temperature range: -60°C / +105°C
 Protection class: IP 68 (30 bar)
 Test standard: IEC EN 60079-0 / IEC EN 60079-1 / IEC EN 60079-7 / IEC EN 60079-31

Gas: II 2G Ex db eb IIC Gb
 Staub: II 2D Ex tb IIIC Db
 Zone: Gas 1 und 2 / Staub 21 und 22

Gas: II 2G Ex db eb IIC Gb
 Dust: II 2D Ex tb IIIC Db
 Zone: Gas 1 and 2 / dust 21 and 22

Zertifikat: SEV 17 ATEX 0153
 IECEx Zertifikat: IECEx SEV 17.0017

Certificate: SEV 17 ATEX 0153
 IECEx Certificate: IECEx SEV 17.0017

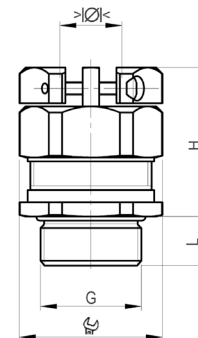

EX Compact MS KB



Einteiliger Dichteinsatz
 nicht durchgehend isolierend

One-piece sealing insert
 not overall length insulated

G	> Ø < min mm	> Ø < max mm	 mm	H mm	L mm	Art.-Nr. Art. No.	
M16x1.5	3.0	7.0	21	34	12	EX1826.17.070	25
M16x1.5	5.0	10.0	24	35	12	EX1826.17.100	25
M20x1.5	5.0	11.0	24	35	12	EX1826.20.110	25
M20x1.5	9.0	14.0	30	35	12	EX1826.20.140	25
M25x1.5	7.5	15.0	32	37	12	EX1826.25.150	20
M25x1.5	12.5	18.0	32	37	12	EX1826.25.180	20
M32x1.5	17.0	23.0	41	42	12	EX1826.32.230	10
M32x1.5	21.0	26.0	41	42	12	EX1826.32.260	10
M40x1.5	21.0	26.0	41	42	14	EX1826.40.260	10
M40x1.5	24.0	32.0	50	47	14	EX1826.40.320	10
M50x1.5	28.0	36.0	55	48	14	EX1826.50.360	5
M50x1.5	35.0	42.0	60	50	14	EX1826.50.420	5
M63x1.5	36.0	44.0	65	51	14	EX1826.63.440	1
M63x1.5	43.0	50.0	70	51	14	EX1826.63.500	1

Auf Anfrage lieferbar:
 Anschlussgewinde Pg und NPT
 Rostfreier Stahl A2 oder A4

Available on request:
 Entry thread Pg and NPT
 Stainless steel A2 or A4



Anschlussgewinde NPT | Entry thread NPT

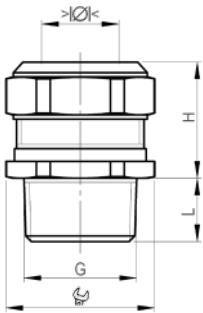

Material: Messing vernickelt
 Dichtung: NBR
 Einsatztemperatur: -60°C / +105°C
 Schutzart: IP 68 (30 bar)
 Prüfnorm: IEC EN 60079-0 / IEC EN 60079-1 / IEC EN 60079-7 / IEC EN 60079-31
 Gas: II 2G Ex db eb IIC
 Staub: II 2D Ex ta IIIC
 Zone: Gas 1 und 2 / Staub 21 und 22
 Zertifikat: PTB 10 ATEX 1034X
 IECEx Zertifikat: IECEx PTB 12.0055X

Material: Nickel-plated brass
 Seal: NBR
 Temperature range: -60°C / +105°C
 Protection class: IP 68 (30 bar)
 Test standard: IEC EN 60079-0 / IEC EN 60079-1 / IEC EN 60079-7 / IEC EN 60079-31
 Gas: II 2G Ex db eb IIC
 Dust: II 2D Ex ta IIIC
 Zone: Gas 1 and 2 / dust 21 and 22
 Certificate: PTB 10 ATEX 1034X
 IECEx Certificate: IECEx PTB 12.0055X

EX Compact MS



Einteiliger Dichteinsatz
 nicht durchgehend isolierend

One-piece sealing insert
 not overall length insulated

G	> Ø < min mm	> Ø < max mm	mm	H mm	L mm	Art.-Nr. Art. No.	
NPT 3/8"	3.0	7.0	21	26	15	EX1126.3/8NPT.070	25
NPT 3/8"	5.0	10.0	24	26	15	EX1126.3/8NPT.100	25
NPT 1/2"	5.0	11.0	24	26	15	EX1126.1/2NPT.110	25
NPT 1/2"	9.0	14.0	30	26	15	EX1126.1/2NPT.140	25
NPT 3/4"	7.5	15.0	32	28	15	EX1126.3/4NPT.150	20
NPT 3/4"	12.5	18.0	32	28	15	EX1126.3/4NPT.180	20
NPT 1"	17.0	23.0	41	33	20	EX1126.1NPT.230	10
NPT 1"	21.0	26.0	41	33	20	EX1126.1NPT.260	10
NPT 1 1/4"	24.0	32.0	50	34	20	EX1126.11/4NPT.320	10
NPT 1 1/2"	28.0	36.0	55	34	20	EX1126.11/2NPT.360	5
NPT 2"	36.0	44.0	65	35	22	EX1126.2NPT.440	5

Auf Anfrage lieferbar:
 Ausführungen in Stahl A2 und A4

Available on request:
 Executions in steel A2 and A4

Zubehör zu Kabelverschraubungen Messing druckfeste Kapselung Ex d IIC

Accessories for cable glands nickel-plated brass for flameproof enclosure Ex d IIC

Anschlussgewinde metrisch | Entry thread metric



Verschlusschrauben Messing druckfeste Kapselung Ex d IIC

Material:	Messing vernickelt
O-Ring:	FPM
Einsatztemperatur:	-40°C / +100°C
Schutzart:	IP 68 (30 bar)
Prüfnorm:	IEC EN 60079-0 / IEC EN 60079-1 / IEC EN 60079-31
Gas:	II 2G Ex db eb IIC
Staub:	II 2D Ex ta IIIC
Zone:	Gas 1 und 2 / Staub 21 und 22
Zertifikat:	PTB 00 ATEX 1059
IECEx Zertifikat:	IECEx PTB 12.0056

Locking plugs nickel-plated brass flameproof enclosure Ex d IIC

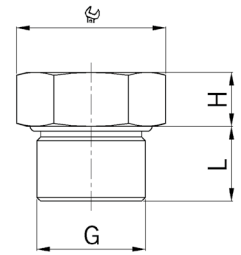
Material:	Nickel-plated brass
O-ring:	FPM
Temperature range:	-40°C / +100°C
Protection class:	IP 68 (30 bar)
Test standard:	IEC EN 60079-0 / IEC EN 60079-1 / IEC EN 60079-31
Gas:	II 2G Ex db eb IIC
Dust:	II 2D Ex ta IIIC
Zone:	Gas 1 and 2 / dust 21 and 22
Certificate:	PTB 00 ATEX 1059
IECEx Certificate:	IECEx PTB 12.0056





mit O-Ring				with O-ring		
G	 mm	H mm	L mm	Art.-Nr. Art. No.		
M12x1.5	15	5	15	8710.12	10	
M16x1.5	18	6	15	8710.17	10	
M20x1.5	24	8	15	8710.20	10	
M25x1.5	30	10	15	8710.25	10	
M32x1.5	36	12	15	8710.32	10	
M40x1.5	46	12	15	8710.40	10	
M50x1.5	55	12	15	8710.50	10	
M63x1.5	70	12	15	8710.63	10	



Anschlussgewinde Pg | Entry thread Pg



mit O-Ring				with O-ring		
G	 mm	H mm	L mm	Art.-Nr. Art. No.		
Pg 7	16	6.4	10.5	8710.07	10	
Pg 9	18	7.5	12	8710.09	10	
Pg 11	21	8.8	12	8710.11	10	
Pg 13	24	10.0	14	8710.13	10	
Pg 16	27	11.5	14	8710.16	10	
Pg 21	32	14.0	16	8710.21	10	
Pg 29	41	17.0	17	8710.29	10	
Pg 36	55	22.5	17	8710.36	10	



Zubehör zu Kabelverschraubungen Messing druckfeste Kapselung Ex d IIC

Accessories for cable glands nickel-plated brass for flameproof enclosure Ex d IIC

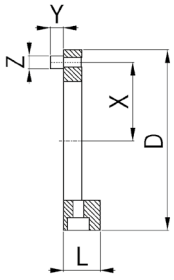

Sicherungsringe zu Kabelverschraubungen für druckfeste Kapselung Ex d IIC

Material: Messing vernickelt
 Schrauben: Rostfreier Stahl A2
 Einsatztemperatur: -60°C / +200°C
 Einsatzbereich: Zusätzlicher Schutz gegen Selbstlockerung bei Vibrationen

Locking rings suitable for cable glands for flameproof enclosure Ex d IIC

Material: Nickel-plated brass
 Screws: Stainless steel A2
 Temperature range: -60°C / +200°C
 Application: Additional safety against self-opening due to vibrations



Sicherungsring nach Schlüsselweite der Ex d IIC Kabelverschraubung bestimmen

The dimension of the locking ring has to match the wrench size of the Ex d IIC cable gland

W mm	D mm	L mm	X mm	Y mm	ØZ mm	Art.-Nr. Art. No.	
20	40	13	15	5	5	1809.26.50	50
24	47	13	18	5	5	1811.26.50	50
26	50	13	20	5	5	1816.26.50	50
32	56	13	23	5	5	1821.26.50	50
36	60	13	25	5	5	1821.27.50	50
45	69	14	30	5	5	1829.26.50	50

AGRO Kabelverschraubungen Progress® Messing erhöhte Sicherheit Ex e II

AGRO cable glands Progress® nickel-plated brass increased safety Ex e II

Kurzes Anschlussgewinde metrisch | Short entry thread metric

Material: Messing vernickelt
 Dichtung: TPE
 O-Ring: FPM
 Einsatztemperatur: -60°C / +100°C
 Schutzart: IP 66 / IP 68 (bis 10 bar)
 Prüfnorm: IEC EN 60079-0 / IEC EN 60079-7 / IEC EN 60079-31
 Gas: II 2G Ex eb IIC Gb
 Staub: II 2D Ex tb IIIC Db
 Zone: Gas 1 und 2 / Staub 21 und 22
 Zertifikat: SEV 15 ATEX 0152X
 IECEx Zertifikat: IECEx SEV 15.0019X

Material: Nickel-plated brass
 Seal: TPE
 O-ring: FPM
 Temperature range: -60°C / +100°C
 Protection class: IP 66 / IP 68 (up to 10 bar)
 Test standard: IEC EN 60079-0 / IEC EN 60079-7 / IEC EN 60079-31
 Gas: II 2G Ex eb IIC Gb
 Dust: II 2D Ex tb IIIC Db
 Zone: Gas 1 and 2 / dust 21 and 22
 Certificate: SEV 15 ATEX 0152X
 IECEx Certificate: IECEx SEV 15.0019X

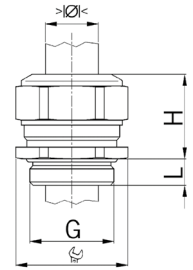

Progress MS EX



Einteiliger Dichteinsatz
 nicht durchgehend isolierend

One-piece sealing insert
 not overall length insulated

G	>Ø< min mm	>Ø< max mm	Ø mm	H mm	L mm	i info	Art.-Nr. Art. No.	
M8x1.25	3.0	3.5	11	14	5	1	EX1000.08.035	50
M8x1.25	4.0	5.0	11	14	5	1	EX1000.08.050	50
M10x1.5	3.0	4.0	13	15	5	1	EX1000.10.040	50
M10x1.5	4.5	6.0	13	15	5	1	EX1000.10.060	50
M12x1.5	5.0	6.5	15	17	5	-	EX1000.12.065	50
M12x1.5	6.5	8.0	15	17	5	-	EX1000.12.080	50
M16x1.5	4.5	6.0	18	20	5	-	EX1000.17.060	50
M16x1.5	6.0	8.0	18	20	5	-	EX1000.17.080	50
M20x1.5	6.0	8.0	24	21	6	-	EX1000.20.080	50
M20x1.5	8.0	11.0	24	21	6	-	EX1000.20.110	50
M25x1.5	9.5	12.5	30	25	7	-	EX1000.25.125	25
M25x1.5	12.5	16.0	30	27	7	-	EX1000.25.160	25
M32x1.5	14.0	17.0	36	28	8	-	EX1000.32.170	25
M32x1.5	17.0	21.0	36	28	8	-	EX1000.32.210	25
M40x1.5	20.0	24.0	46	31	8	-	EX1000.40.240	10
M40x1.5	24.0	28.5	46	31	8	-	EX1000.40.285	10



1 = Metrisches Regelgewinde (mit VDE Testreport)

1 = Metric coarse-pitch thread (with VDE test report)

Auf Anfrage lieferbar:

Available on request:

Ausführungen in Stahl A2 und A4, Anschlussgewinde NPT

Executions in steel A2 and A4, entry thread NPT

AGRO Kabelverschraubungen Progress® Messing erhöhte Sicherheit Ex e II

AGRO cable glands Progress® nickel-plated brass increased safety Ex e II

Langes Anschlussgewinde metrisch | Long entry thread metric

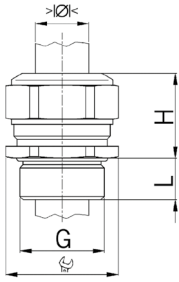

Material: Messing vernickelt
 Dichtung: TPE
 O-Ring: FPM
 Einsatztemperatur: -60°C / +100°C
 Schutzart: IP 66 / IP 68 (bis 10 bar)
 Prüfnorm: IEC EN 60079-0 / IEC EN 60079-7 / IEC EN 60079-31
 Gas: II 2G Ex eb IIC Gb
 Staub: II 2D Ex tb IIIC Db
 Zone: Gas 1 und 2 / Staub 21 und 22
 Zertifikat: SEV 15 ATEX 0152X
 IECEx Zertifikat: IECEx SEV 15.0019X

Material: Nickel-plated brass
 Seal: TPE
 O-ring: FPM
 Temperature range: -60°C / +100°C
 Protection class: IP 66 / IP 68 (up to 10 bar)
 Test standard: IEC EN 60079-0 / IEC EN 60079-7 / IEC EN 60079-31
 Gas: II 2G Ex eb IIC Gb
 Dust: II 2D Ex tb IIIC Db
 Zone: Gas 1 and 2 / dust 21 and 22
 Certificate: SEV 15 ATEX 0152X
 IECEx Certificate: IECEx SEV 15.0019X



Progress MS EX



Einteiliger Dichteinsatz
 nicht durchgehend isolierend

One-piece sealing insert
 not overall length insulated

G	> Ø < min mm	> Ø < max mm	mm	H mm	L mm	i info	Art.-Nr. Art. No.	
M8x1.25	3.0	3.5	11	14	10	1	EX1100.08.035	50
M8x1.25	4.0	5.0	11	14	10	1	EX1100.08.050	50
M10x1.5	3.0	4.0	13	15	10	1	EX1100.10.040	50
M10x1.5	4.5	6.0	13	15	10	1	EX1100.10.060	50
M12x1.5	5.0	6.5	15	17	10	-	EX1100.12.065	50
M12x1.5	6.5	8.0	15	17	10	-	EX1100.12.080	50
M16x1.5	4.5	6.0	18	20	10	-	EX1100.17.060	50
M16x1.5	6.0	8.0	18	20	10	-	EX1100.17.080	50
M20x1.5	6.0	8.0	24	21	10	-	EX1100.20.080	50
M20x1.5	8.0	11.0	24	21	10	-	EX1100.20.110	50
M25x1.5	9.5	12.5	30	25	11	-	EX1100.25.125	25
M25x1.5	12.5	16.0	30	27	11	-	EX1100.25.160	25
M32x1.5	14.0	17.0	36	28	13	-	EX1100.32.170	25
M32x1.5	17.0	21.0	36	28	13	-	EX1100.32.210	25
M40x1.5	20.0	24.0	46	31	13	-	EX1100.40.240	10
M40x1.5	24.0	28.5	46	31	13	-	EX1100.40.285	10

1 = Metrisches Regelgewinde (mit VDE Testreport)

1 = Metric coarse-pitch thread (with VDE test report)

Auf Anfrage lieferbar:

Available on request:

Ausführungen in Stahl A2 und A4, Anschlussgewinde NPT

Executions in steel A2 and A4, entry thread NPT

AGRO Kabelverschraubungen Progress® Messing erhöhte Sicherheit Ex e II

AGRO cable glands Progress® nickel-plated brass increased safety Ex e II

Kurzes Anschlussgewinde Pg | Short entry thread Pg

Material: Messing vernickelt
 Dichtung: TPE
 O-Ring: FPM
 Einsatztemperatur: -60°C / +100°C
 Schutzart: IP 66 / IP 68 (bis 10 bar)
 Prüfnorm: IEC EN 60079-0 / IEC EN 60079-7 / IEC EN 60079-31
 Gas: II 2G Ex eb IIC Gb
 Staub: II 2D Ex tb IIIC Db
 Zone: Gas 1 und 2 / Staub 21 und 22
 Zertifikat: SEV 15 ATEX 0152X
 IECEx Zertifikat: IECEx SEV 15.0019X

Material: Nickel-plated brass
 Seal: TPE
 O-ring: FPM
 Temperature range: -60°C / +100°C
 Protection class: IP 66 / IP 68 (up to 10 bar)
 Test standard: IEC EN 60079-0 / IEC EN 60079-7 / IEC EN 60079-31
 Gas: II 2G Ex eb IIC Gb
 Dust: II 2D Ex tb IIIC Db
 Zone: Gas 1 and 2 / dust 21 and 22
 Certificate: SEV 15 ATEX 0152X
 IECEx Certificate: IECEx SEV 15.0019X

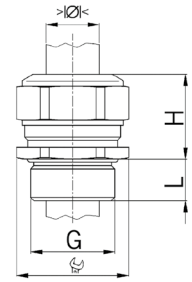

Progress MS EX



Einteiliger Dichteinsatz
 nicht durchgehend isolierend

One-piece sealing insert
 not overall length insulated

G	>D1< min mm	>D1< max mm	 mm	H mm	L mm	Art.-Nr. Art. No.	
Pg 7	5.0	6.5	15	17	6	EX1000.07.065	50
Pg 7	6.5	8.0	15	17	6	EX1000.07.080	50
Pg 9	4.5	6.0	18	20	6	EX1000.09.060	50
Pg 9	6.0	8.0	18	20	6	EX1000.09.080	50
Pg 11	4.0	5.5	21	21	6	EX1000.11.055	50
Pg 11	5.5	8.5	21	21	6	EX1000.11.085	50
Pg 13	6.0	8.0	24	21	6	EX1000.13.080	50
Pg 13	8.0	11.0	24	21	6	EX1000.13.110	50
Pg 16	6.0	8.0	24	21	6	EX1000.16.080	50
Pg 16	8.0	11.0	24	21	6	EX1000.16.110	50
Pg 21	9.5	12.5	30	25	7.5	EX1000.21.125	25
Pg 21	12.5	16.0	30	25	7.5	EX1000.21.160	25
Pg 29	16.0	19.0	38	28	8	EX1000.29.190	25
Pg 29	19.0	23.0	38	28	8	EX1000.29.230	25
Pg 36	21.5	26.0	50	32	8	EX1000.36.260	10
Pg 36	26.0	30.5	50	32	8	EX1000.36.305	10



Auf Anfrage lieferbar:

Available on request:

Ausführungen in Stahl A2 und A4, Anschlussgewinde NPT

Executions in steel A2 and A4, entry thread NPT

AGRO Kabelverschraubungen Progress® Messing erhöhte Sicherheit Ex e II

AGRO cable glands Progress® nickel-plated brass increased safety Ex e II

Langes Anschlussgewinde Pg | Long entry thread Pg

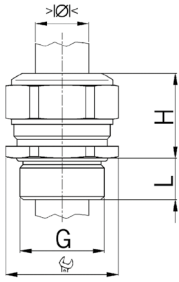

Material: Messing vernickelt
 Dichtung: TPE
 O-Ring: FPM
 Einsatztemperatur: -60°C / +100°C
 Schutzart: IP 66 / IP 68 (bis 10 bar)
 Prüfnorm: IEC EN 60079-0 / IEC EN 60079-7 / IEC EN 60079-31
 Gas: II 2G Ex eb IIC Gb
 Staub: II 2D Ex tb IIIC Db
 Zone: Gas 1 und 2 / Staub 21 und 22
 Zertifikat: SEV 15 ATEX 0152X
 IECEx Zertifikat: IECEx SEV 15.0019X

Material: Nickel-plated brass
 Seal: TPE
 O-ring: FPM
 Temperature range: -60°C / +100°C
 Protection class: IP 66 / IP 68 (up to 10 bar)
 Test standard: IEC EN 60079-0 / IEC EN 60079-7 / IEC EN 60079-31
 Gas: II 2G Ex eb IIC Gb
 Dust: II 2D Ex tb IIIC Db
 Zone: Gas 1 and 2 / dust 21 and 22
 Certificate: SEV 15 ATEX 0152X
 IECEx Certificate: IECEx SEV 15.0019X



Progress MS EX



Einteiliger Dichteinsatz
 nicht durchgehend isolierend

One-piece sealing insert
 not overall length insulated

G	> Ø < min mm	> Ø < max mm	mm	H mm	L mm	Art.-Nr. Art. No.	
Pg 7	5.0	6.5	15	17	10	EX1100.07.065	50
Pg 7	6.5	8.0	15	17	10	EX1100.07.080	50
Pg 9	4.5	6.0	18	20	10	EX1100.09.060	50
Pg 9	6.0	8.0	18	20	10	EX1100.09.080	50
Pg 11	4.0	5.5	21	21	10	EX1100.11.055	50
Pg 11	5.5	8.5	21	21	10	EX1100.11.085	50
Pg 13	6.0	8.0	24	21	10	EX1100.13.080	50
Pg 13	8.0	11.0	24	21	10	EX1100.13.110	50
Pg 16	6.0	8.0	24	21	10	EX1100.16.080	50
Pg 16	8.0	11.0	24	21	10	EX1100.16.110	50
Pg 21	9.5	12.5	30	25	12	EX1100.21.125	25
Pg 21	12.5	16.0	30	25	12	EX1100.21.160	25
Pg 29	16.0	19.0	38	28	12	EX1100.29.190	25
Pg 29	19.0	23.0	38	28	12	EX1100.29.230	25
Pg 36	21.5	26.0	50	32	15	EX1100.36.260	10
Pg 36	26.0	30.5	50	32	15	EX1100.36.305	10

Auf Anfrage lieferbar:

Available on request:

Ausführungen in Stahl A2 und A4, Anschlussgewinde NPT

Executions in steel A2 and A4, entry thread NPT

AGRO Kabelverschraubungen Progress® Messing erhöhte Sicherheit Ex e II für mehrere Kabel AGRO cable glands Progress® nickel-plated brass increased safety Ex e II for installation of multiple cables

Kurzes Anschlussgewinde metrisch | Short entry thread metric

Material: Messing vernickelt
Dichtung: TPE / NBR
O-Ring: FPM
Einsatztemperatur: -60°C / +100°C
Schutzart: IP 66 / IP 68
Prüfnorm: IEC EN 60079-0 / IEC EN 60079-7 / IEC EN 60079-31
Gas: II 2G Ex eb IIC Gb
Staub: II 2D Ex tb IIIC Db
Zone: Gas 1 und 2 / Staub 21 und 22
Zertifikat: SEV 15 ATEX 0152X
IECEx Zertifikat: IECEx SEV 15.0019X

Material: Nickel-plated brass
Seal: TPE / NBR
O-ring: FPM
Temperature range: -60°C / +100°C
Protection class: IP 66 / IP 68
Test standard: IEC EN 60079-0 / IEC EN 60079-7 / IEC EN 60079-31
Gas: II 2G Ex eb IIC Gb
Dust: II 2D Ex tb IIIC Db
Zone: Gas 1 and 2 / dust 21 and 22
Certificate: SEV 15 ATEX 0152X
IECEx Certificate: IECEx SEV 15.0019X

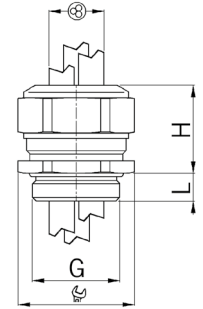

Progress MS Multi EX



Einteiliger Dichteinsatz
nicht durchgehend isolierend

One-piece sealing insert
not overall length insulated

G	>Ø< min mm	>Ø< max mm	⊗	⊗ mm	H mm	L mm	i info	Art.-Nr. Art. No.	
M12x1.5	0.6	1.0	3	15	17	5	3	EX1310.12.3.010	50
M16x1.5	1.0	1.5	4	18	20	5	3	EX1310.17.4.015	50
M16x1.5	2.0	3.0	2	18	20	5	-	EX1310.17.2.030	50
M20x1.5	2.5	3.0	6	24	21	6	-	EX1310.20.6.030	50
M20x1.5	3.5	5.0	2	24	21	6	-	EX1310.20.2.050	50
M20x1.5	3.5	5.0	4	24	21	6	-	EX1310.20.4.050	50
M20x1.5	4.5	6.0	3	24	21	6	-	EX1310.20.3.060	50
M20x1.5	5.5	7.5	2	24	21	6	-	EX1310.20.2.075	50
M25x1.5	5.0	6.0	6	30	25	7	-	EX1310.25.6.060	25
M25x1.5	6.0	7.0	3	30	25	7	-	EX1310.25.3.070	25
M25x1.5	5.5	7.0	4	30	25	7	-	EX1310.25.4.070	25
M25x1.5	7.5	9.0	3	30	25	7	-	EX1310.25.3.090	25
M25x1.5	8.0	10.0	2	30	25	7	-	EX1310.25.2.100	25
M32x1.5	6.0	7.0	6	36	28	8	-	EX1310.32.6.070	25
M32x1.5	7.5	9.0	4	36	28	8	-	EX1310.32.4.090	25
M40x1.5	8.0	9.0	7	46	31	8	3	EX1310.40.7.090	10
M40x1.5	14.0	15.0	2	46	31	8	3	EX1310.40.2.150	10
M50x1.5	9.0	10.0	4	55	34	9	3	EX1310.50.4.100	10
M63x1.5	11.0	12.0	6	70	37	10	3	EX1310.63.6.120	5
M63x1.5	17.0	18.0	3	70	37	10	3	EX1310.63.3.180	5

3 = Material Dichteinsatz NBR

3 = Material sealing insert NBR

Auf Anfrage lieferbar:

Available on request:

Ausführungen in Stahl A2 und A4, Anschlussgewinde NPT

Executions in steel A2 and A4, entry thread NPT



AGRO Kabelverschraubungen Progress® Messing erhöhte Sicherheit Ex e II für mehrere Kabel AGRO cable glands Progress® nickel-plated brass increased safety Ex e II for installation of multiple cables

Kurzes Anschlussgewinde Pg | Short entry thread Pg

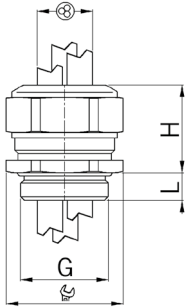

Material: Messing vernickelt
 Dichtung: TPE / NBR
 O-Ring: FPM
 Einsatztemperatur: -60°C / +100°C
 Schutzart: IP 66 / IP 68
 Prüfnorm: IEC EN 60079-0 / IEC EN 60079-7 / IEC EN 60079-31
 Gas: II 2G Ex eb IIC Gb
 Staub: II 2D Ex tb IIIC Db
 Zone: Gas 1 und 2 / Staub 21 und 22
 Zertifikat: SEV 15 ATEX 0152X
 IECEx Zertifikat: IECEx SEV 15.0019X

Material: Nickel-plated brass
 Seal: TPE / NBR
 O-ring: FPM
 Temperature range: -60°C / +100°C
 Protection class: IP 66 / IP 68
 Test standard: IEC EN 60079-0 / IEC EN 60079-7 / IEC EN 60079-31
 Gas: II 2G Ex eb IIC Gb
 Dust: II 2D Ex tb IIIC Db
 Zone: Gas 1 and 2 / dust 21 and 22
 Certificate: SEV 15 ATEX 0152X
 IECEx Certificate: IECEx SEV 15.0019X



Progress MS Multi EX



Einteiliger Dichteinsatz
 nicht durchgehend isolierend

One-piece sealing insert
 not overall length insulated

G	>Ø< min mm	>Ø< max mm	⊗	⊗ mm	H mm	L mm	i info	Art.-Nr. Art. No.	⊞
Pg 9	1.0	1.5	4	18	20	6	3	EX1310.09.4.015	50
Pg 9	2.0	3.0	2	18	20	6	-	EX1310.09.2.030	50
Pg 11	2.0	3.0	3	21	21	6	3	EX1310.11.3.030	50
Pg 11	3.0	4.0	2	21	21	6	3	EX1310.11.2.040	50
Pg 11	3.5	5.0	2	21	21	6	-	EX1310.11.2.050	50
Pg 13	2.5	4.0	3	24	23	6	3	EX1310.13.3.040	50
Pg 13	3.5	5.0	2	24	23	6	-	EX1310.13.2.050	50
Pg 16	2.5	3.0	6	24	23	6	-	EX1310.16.6.030	50
Pg 16	3.0	4.0	6	24	23	6	3	EX1310.16.6.040	50
Pg 16	4.5	6.0	2	24	23	6	-	EX1310.16.2.060	50
Pg 16	4.5	6.0	3	24	23	6	-	EX1310.16.3.060	50
Pg 21	5.5	7.0	4	30	28	7	-	EX1310.21.4.070	25
Pg 21	7.5	9.0	3	30	28	7	-	EX1310.21.3.090	25
Pg 29	5.5	6.5	6	38	28	8	3	EX1310.29.6.065	25
Pg 29	8.0	9.0	3	38	28	8	-	EX1310.29.3.090	25
Pg 36	9.0	10.0	4	50	32	8	3	EX1310.36.4.100	10
Pg 36	14.0	15.0	2	50	32	8	3	EX1310.36.2.150	10
Pg 48	11.0	12.0	6	65	37	11	3	EX1310.48.6.120	10
Pg 48	17.0	18.0	3	65	37	11	3	EX1310.48.3.180	10

3 = Material Dichteinsatz NBR

3 = Material sealing insert NBR

Auf Anfrage lieferbar:

Available on request:

Ausführungen in Stahl A2 und A4, Anschlussgewinde NPT

Executions in steel A2 and A4, entry thread NPT

AGRO Kabelverschraubungen Progress® Messing mit Klemmbacken erhöhte Sicherheit Ex e II

AGRO cable glands Progress® nickel-plated brass with clamps increased safety Ex e II

Kurzes Anschlussgewinde metrisch | Short entry thread metric

Material:	Messing vernickelt	Material:	Nickel-plated brass
Schrauben:	Rostfreier Stahl A2	Screws:	Stainless steel A2
Dichtung:	TPE	Seal:	TPE
O-Ring:	FPM	O-ring:	FPM
Einsatztemperatur:	-60°C / +100°C	Temperature range:	-60°C / +100°C
Schutzart:	IP 66 / IP 68 (bis 10 bar)	Protection class:	IP 66 / IP 68 (up to 10 bar)
Prüfnorm:	IEC EN 60079-0 / IEC EN 60079-7 / IEC EN 60079-31	Test standard:	IEC EN 60079-0 / IEC EN 60079-7 / IEC EN 60079-31
Gas:	II 2G Ex eb IIC Gb	Gas:	II 2G Ex eb IIC Gb
Staub:	II 2D Ex tb IIIC Db	Dust:	II 2D Ex tb IIIC Db
Zone:	Gas 1 und 2 / Staub 21 und 22	Zone:	Gas 1 and 2 / dust 21 and 22
Zertifikat:	SEV 15 ATEX 0151	Certificate:	SEV 15 ATEX 0151
IECEx Zertifikat:	IECEx SEV 15.0018	IECEx Certificate:	IECEx SEV 15.0018

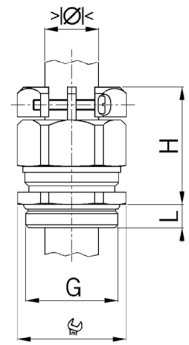

Progress MS KB EX



Einteiliger Dichteinsatz
nicht durchgehend isolierend

One-piece sealing insert
not overall length insulated

G	>Ø< min mm	>Ø< max mm	mm	H mm	L mm	i info	Art.-Nr. Art. No.	
M12x1.5	5.0	6.5	15/16	26	5	2	EX1803.12.03.065	50
M12x1.5	6.5	8.0	15/16	26	5	2	EX1803.12.03.080	50



2 = Zertifikat SEV 15 ATEX 0152X / IECEx SEV 15.0019X

2 = Certificate SEV 15 ATEX 0152X / IECEx SEV 15.0019X

Folgende EX-Kabelverschraubungen mit Klemmbacken Ex e II sind auf Anfrage erhältlich:

The following cable glands with clamps Ex e II are available on request:

- Kabelverschraubungen Messing mit langem Anschlussgewinde
- Kabelverschraubungen aus rostfreiem Stahl A2 oder A4

- Cable glands nickel-plated brass with long entry thread
- Cable glands stainless steel A2 or A4

Progress MS KB EX



Zweiteiliger Dichteinsatz
nicht durchgehend isolierend

Two-piece sealing insert
not overall length insulated

G	>Ø< min mm	>Ø< max mm	>Ø< min mm	>Ø< max mm	mm	H mm	L mm	i info	Art.-Nr. Art. No.	
M16x1.5	6.0	8.0	8.0	10.5	18/19	30	5	-	EX1803.17	50
M20x1.5	8.0	11.0	11.0	15.0	24	31	6	-	EX1803.20	50
M25x1.5	12.5	16.0	16.0	20.5	30	35	7	-	EX1803.25	25
M32x1.5	17.0	21.0	21.0	25.5	36	40	8	-	EX1803.32	25
M40x1.5	24.0	28.5	28.5	33.0	46	44	8	-	EX1803.40	10
M50x1.5	33.0	37.0	37.0	42.0	55	49	9	-	EX1803.50	10
M63x1.5	40.0	46.0	46.0	52.0	70	55	10	-	EX1803.63	5



Folgende EX-Kabelverschraubungen mit Klemmbacken Ex e II sind auf Anfrage erhältlich:

The following cable glands with clamps Ex e II are available on request:

- Kabelverschraubungen Messing mit langem Anschlussgewinde
- Kabelverschraubungen aus rostfreiem Stahl A2 oder A4

- Cable glands nickel-plated brass with long entry thread
- Cable glands stainless steel A2 or A4

AGRO Kabelverschraubungen Progress® Messing mit Klemmbacken erhöhte Sicherheit Ex e II

AGRO cable glands Progress® nickel-plated brass with clamps increased safety Ex e II

Kurzes Anschlussgewinde Pg | Short entry thread Pg

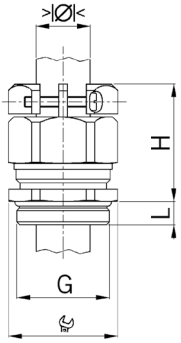

Material:	Messing vernickelt
Schrauben:	Rostfreier Stahl A2
Dichtung:	TPE
O-Ring:	FPM
Einsatztemperatur:	-60°C / +100°C
Schutzart:	IP 66 / IP 68 (bis 10 bar)
Prüfnorm:	IEC EN 60079-0 / IEC EN 60079-7 / IEC EN 60079-31
Gas:	II 2G Ex eb IIC Gb
Staub:	II 2D Ex tb IIIC Db
Zone:	Gas 1 und 2 / Staub 21 und 22
Zertifikat:	SEV 15 ATEX 0151
IECEX Zertifikat:	IECEX SEV 15.0018

Material:	Nickel-plated brass
Screws:	Stainless steel A2
Seal:	TPE
O-ring:	FPM
Temperature range:	-60°C / +100°C
Protection class:	IP 66 / IP 68 (up to 10 bar)
Test standard:	IEC EN 60079-0 / IEC EN 60079-7 / IEC EN 60079-31
Gas:	II 2G Ex eb IIC Gb
Dust:	II 2D Ex tb IIIC Db
Zone:	Gas 1 and 2 / dust 21 and 22
Certificate:	SEV 15 ATEX 0151
IECEX Certificate:	IECEX SEV 15.0018



Progress MS KB EX



Einteiliger Dichteinsatz
nicht durchgehend isolierend

One-piece sealing insert
not overall length insulated

G	> Ø < min mm	> Ø < max mm	mm	H mm	L mm	i info	Art.-Nr. Art. No.	
Pg 7	5.0	6.5	15/16	26	6	2	EX1803.07.03.065	50
Pg 7	6.5	8.0	15/16	26	6	2	EX1803.07.03.080	50

2 = Zertifikat SEV 15 ATEX 0152X / IECEx SEV 15.0019X

2 = Certificate SEV 15 ATEX 0152X / IECEx SEV 15.0019X

Folgende EX-Kabelverschraubungen mit Klemmbacken Ex e II sind auf Anfrage erhältlich:

The following cable glands with clamps Ex e II are available on request:

- Kabelverschraubungen Messing mit langem Anschlussgewinde
- Kabelverschraubungen aus rostfreiem Stahl A2 oder A4

- Cable glands nickel-plated brass with long entry thread
- Cable glands stainless steel A2 or A4

Progress MS KB EX



Zweiteiliger Dichteinsatz
nicht durchgehend isolierend

Two-piece sealing insert
not overall length insulated

G	> Ø < min mm	> Ø < max mm	> Ø < min mm	> Ø < max mm	mm	H mm	L mm	i info	Art.-Nr. Art. No.	
Pg 9	6.0	8.0	8.0	10.5	18/19	30	6	-	EX1803.09	50
Pg 11	5.5	8.5	8.5	12.0	21	31	6	-	EX1803.11	50
Pg 13	8.0	11.0	11.0	15.0	24	31	6	-	EX1803.13	50
Pg 16	8.0	11.0	11.0	15.0	24	31	6	-	EX1803.16	50
Pg 21	12.5	16.0	16.0	20.5	30	35	7.5	-	EX1803.21	25
Pg 29	19.0	23.0	23.0	27.5	38	40	8	-	EX1803.29	25
Pg 36	26.0	30.5	30.5	35.0	50	47	8	-	EX1803.36	10
Pg 42	33.0	37.0	37.0	42.0	55	49	10	-	EX1803.42	10
Pg 48	37.0	43.0	43.0	49.0	65	51	11	-	EX1803.48	5

Folgende EX-Kabelverschraubungen mit Klemmbacken Ex e II sind auf Anfrage erhältlich:

The following cable glands with clamps Ex e II are available on request:

- Kabelverschraubungen Messing mit langem Anschlussgewinde
- Kabelverschraubungen aus rostfreiem Stahl A2 oder A4

- Cable glands nickel-plated brass with long entry thread
- Cable glands stainless steel A2 or A4

Kurzes Anschlussgewinde metrisch | Short entry thread metric

Material: Messing vernickelt
 Schrauben: Rostfreier Stahl A2
 Dichtung: TPE
 O-Ring: FPM
 Einsatztemperatur: -60°C / +100°C
 Schutzart: IP 66 / IP 68 (bis 10 bar)
 Prüfnorm: IEC EN 60079-0 / IEC EN 60079-7 / IEC EN 60079-31
 Gas: II 2G Ex eb IIC Gb
 Staub: II 2D Ex tb IIIC Db
 Zone: Gas 1 und 2 / Staub 21 und 22
 Zertifikat: SEV 15 ATEX 0151
 IECEx Zertifikat: IECEx SEV 15.0018

Material: Nickel-plated brass
 Screws: Stainless steel A2
 Seal: TPE
 O-ring: FPM
 Temperature range: -60°C / +100°C
 Protection class: IP 66 / IP 68 (up to 10 bar)
 Test standard: IEC EN 60079-0 / IEC EN 60079-7 / IEC EN 60079-31
 Gas: II 2G Ex eb IIC Gb
 Dust: II 2D Ex tb IIIC Db
 Zone: Gas 1 and 2 / dust 21 and 22
 Certificate: SEV 15 ATEX 0151
 IECEx Certificate: IECEx SEV 15.0018

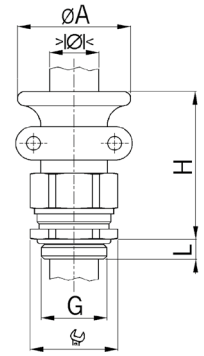

Progress MS T+KB EX



Zweiteiliger Dichteinsatz nicht durchgehend isolierend		Two-piece sealing insert not overall length insulated									
G	> \varnothing < min mm	> \varnothing < max mm	> \varnothing < min mm	> \varnothing < max mm	\varnothing mm	$\varnothing A$ mm	H mm	L mm	Art.-Nr. Art. No.		
M16x1.5	6.0	8.0	8.0	10.5	18	28	43	5	EX1801.17	50	
M20x1.5	8.0	11.0	11.0	15.0	24	34	46	6	EX1801.20	50	
M25x1.5	12.5	16.0	16.0	20.5	30	44	52	7	EX1801.25	25	
M32x1.5	17.0	21.0	21.0	25.5	36	50	59	8	EX1801.32	10	
M40x1.5	24.0	28.5	28.5	33.0	46	57	59	8	EX1801.40	5	



Langes Anschlussgewinde metrisch | Long entry thread metric

Progress MS T+KB EX



Zweiteiliger Dichteinsatz nicht durchgehend isolierend		Two-piece sealing insert not overall length insulated									
G	> \varnothing < min mm	> \varnothing < max mm	> \varnothing < min mm	> \varnothing < max mm	\varnothing mm	$\varnothing A$ mm	H mm	L mm	Art.-Nr. Art. No.		
M16x1.5	6.0	8.0	8.0	10.5	18	28	43	10	EX1811.17	50	
M20x1.5	8.0	11.0	11.0	15.0	24	34	46	10	EX1811.20	50	
M25x1.5	12.5	16.0	16.0	20.5	30	44	52	11	EX1811.25	25	
M32x1.5	17.0	21.5	21.5	25.5	36	50	59	13	EX1811.32	10	
M40x1.5	24.0	28.5	28.5	33.0	46	57	59	13	EX1811.40	5	



Kurzes Anschlussgewinde Pg | Short entry thread Pg

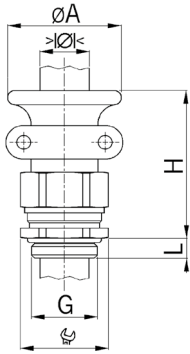

Material:	Messing vernickelt	Material:	Nickel-plated brass
Schrauben:	Rostfreier Stahl A2	Screws:	Stainless steel A2
Dichtung:	TPE	Seal:	TPE
O-Ring:	FPM	O-ring:	FPM
Einsatztemperatur:	-60°C / +100°C	Temperature range:	-60°C / +100°C
Schutzart:	IP 66 / IP 68 (bis 10 bar)	Protection class:	IP 66 / IP 68 (up to 10 bar)
Prüfnorm:	IEC EN 60079-0 / IEC EN 60079-7 / IEC EN 60079-31	Test standard:	IEC EN 60079-0 / IEC EN 60079-7 / IEC EN 60079-31
Gas:	II 2G Ex eb IIC Gb	Gas:	II 2G Ex eb IIC Gb
Staub:	II 2D Ex tb IIIC Db	Dust:	II 2D Ex tb IIIC Db
Zone:	Gas 1 und 2 / Staub 21 und 22	Zone:	Gas 1 and 2 / dust 21 and 22
Zertifikat:	SEV 15 ATEX 0151	Certificate:	SEV 15 ATEX 0151
IECEX Zertifikat:	IECEX SEV 15.0018	IECEX Certificate:	IECEX SEV 15.0018

Progress MS T+KB EX



Zweiteiliger Dichteinsatz
nicht durchgehend isolierend

Two-piece sealing insert
not overall length insulated

G	> Ø < min mm	> Ø < max mm	> Ø < min mm	> Ø < max mm	mm	ØA mm	H mm	L mm	Art.-Nr. Art. No.	
Pg 9	6.0	8.0	8.0	10.5	18	28	43	6	EX1801.09	50
Pg 11	5.5	8.5	8.5	12.0	21	30	43	6	EX1801.11	50
Pg 13	8.0	11.0	11.0	15.0	24	34	46	6	EX1801.13	50
Pg 16	8.0	11.0	11.0	15.0	24	34	46	6	EX1801.16	50
Pg 21	12.5	16.0	16.0	20.5	30	44	52	7.5	EX1801.21	25
Pg 29	19.0	23.0	23.0	27.5	38	50	59	8	EX1801.29	10

Langes Anschlussgewinde Pg | Long entry thread Pg

Progress MS T+KB EX



Zweiteiliger Dichteinsatz
nicht durchgehend isolierend

Two-piece sealing insert
not overall length insulated

G	> Ø < min mm	> Ø < max mm	> Ø < min mm	> Ø < max mm	mm	ØA mm	H mm	L mm	Art.-Nr. Art. No.	
Pg 9	6.0	8.0	8.0	10.5	18	28	43	10	EX1811.09	50
Pg 11	5.5	8.5	8.5	12.0	21	30	43	10	EX1811.11	50
Pg 13	8.0	11.0	11.0	15.0	24	34	46	10	EX1811.13	50
Pg 16	8.0	11.0	11.0	15.0	24	34	46	10	EX1811.16	50
Pg 21	12.5	16.0	16.0	20.5	30	44	52	12	EX1811.21	25
Pg 29	19.0	23.0	23.0	27.5	38	50	59	12	EX1811.29	10

AGRO Kabelverschraubungen Progress® EMV Rapid Messing mit Kontaktscheibe erhöhte Sicherheit Ex e II

AGRO cable glands Progress® EMC Rapid nickel-plated brass with contact disc increased safety EX e II

Kurzes Anschlussgewinde metrisch | Short entry thread metric

Material: Messing vernickelt
 Dichtung: TPE
 O-Ring: FPM
 Einsatztemperatur: -60°C / +100°C
 Schutzart: IP 66 / IP 68 (bis 10 bar)
 Prüfnorm: IEC EN 60079-0 / IEC EN 60079-7 / IEC EN 60079-31
 Gas: II 2G Ex eb IIC Gb
 Staub: II 2D Ex tb IIIC Db
 Zone: Gas 1 und 2 / Staub 21 und 22
 Zertifikat: SEV 15 ATEX 0152X
 IECEx Zertifikat: IECEx SEV 15.0019X
 Eigenschaften: Für zeitsparende Montage von partiell abisolierten sowie durchgehend geschirmten Kabeln

Material: Nickel-plated brass
 Seal: TPE
 O-ring: FPM
 Temperature range: -60°C / +100°C
 Protection class: IP 66 / IP 68 (up to 10 bar)
 Test standard: IEC EN 60079-0 / IEC EN 60079-7 / IEC EN 60079-31
 Gas: II 2G Ex eb IIC Gb
 Dust: II 2D Ex tb IIIC Db
 Zone: Gas 1 and 2 / dust 21 and 22
 Certificate: SEV 15 ATEX 0152X
 IECEx Certificate: IECEx SEV 15.0019X
 Properties: For a quick installation of partially dismantled cables as well as thoroughly shielded cables

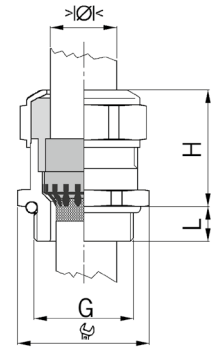

Progress MS EMC Rapid EX



Einteiliger Dichteinsatz
 nicht durchgehend isolierend

One-piece sealing insert
 not overall length insulated

G	> Ø < min mm	> Ø < max mm	mm	H mm	L mm	Art.-Nr. Art. No.	
M12x1.5	4.5	6.0	15	20	5	EX1081.12.060	50
M12x1.5	6.0	7.5	15	20	5	EX1081.12.075	50
M16x1.5	6.0	8.0	18	23	5	EX1081.17.080	50
M16x1.5	8.0	10.0	18	25	5	EX1081.17.100	50
M20x1.5	8.0	11.0	24	25	6	EX1081.20.110	50
M20x1.5	11.0	14.0	24	27	6	EX1081.20.140	50
M25x1.5	13.0	16.0	30	30	7	EX1081.25.160	25
M25x1.5	17.0	19.0	30	33	7	EX1081.25.190	25
M32x1.5	18.0	21.0	36	32	8	EX1081.32.210	25



Langes Anschlussgewinde auf Anfrage

Long entry thread available on request

Kurzes Anschlussgewinde Pg | Short entry thread Pg

Progress MS EMC Rapid EX



Einteiliger Dichteinsatz
 nicht durchgehend isolierend

One-piece sealing insert
 not overall length insulated

G	> Ø < min mm	> Ø < max mm	mm	H mm	L mm	Art.-Nr. Art. No.	
Pg 7	4.5	6.0	15	20	6	EX1081.07.060	50
Pg 7	6.0	7.5	15	20	6	EX1081.07.075	50
Pg 9	6.0	8.0	18	23	6	EX1081.09.080	50
Pg 9	8.0	10.0	18	25	6	EX1081.09.100	50
Pg 11	5.5	8.5	21	25	6	EX1081.11.085	50
Pg 11	8.5	12.0	21	25	6	EX1081.11.120	50
Pg 13	8.0	11.0	24	25	6	EX1081.13.110	50
Pg 13	12.5	14.0	24	27	6	EX1081.13.140	50
Pg 16	8.0	11.0	24	24	6	EX1081.16.110	50
Pg 16	12.5	14.0	24	27	6	EX1081.16.140	50
Pg 21	13.0	16.0	30	30	7	EX1081.21.160	25
Pg 21	17.0	19.0	30	33	7	EX1081.21.190	25
Pg 29	19.0	23.0	38	33	8	EX1081.29.230	25
Pg 29	23.0	25.5	38	32	8	EX1081.29.255	25



Langes Anschlussgewinde auf Anfrage

Long entry thread available on request

AGRO Kabelverschraubungen Progress® EMV Messing mit Kontakthülse erhöhte Sicherheit Ex e II

AGRO EMC cable glands Progress® nickel-plated brass with contact sleeve increased safety Ex e II

Kurzes Anschlussgewinde metrisch | Short entry thread metric

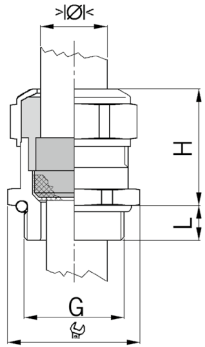

Material:	Messing vernickelt	Material:	Nickel-plated brass
Dichtung:	TPE	Seal:	TPE
O-Ring:	FPM	O-ring:	FPM
Einsatztemperatur:	-60°C / +100°C	Temperature range:	-60°C / +100°C
Schutzart:	IP 66 / IP 68 (bis 10 bar)	Protection class:	IP 66 / IP 68 (up to 10 bar)
Prüfnorm:	IEC EN 60079-0 / IEC EN 60079-7 / IEC EN 60079-31	Test standard:	IEC EN 60079-0 / IEC EN 60079-7 / IEC EN 60079-31
Gas:	II 2G Ex eb IIC Gb	Gas:	II 2G Ex eb IIC Gb
Staub:	II 2D Ex tb IIIC Db	Dust:	II 2D Ex tb IIIC Db
Zone:	Gas 1 und 2 / Staub 21 und 22	Zone:	Gas 1 and 2 / dust 21 and 22
Zertifikat:	SEV 15 ATEX 0152X	Certificate:	SEV 15 ATEX 0152X
IECEx Zertifikat:	IECEx SEV 15.0019X	IECEx Certificate:	IECEx SEV 15.0019X
Eigenschaften:	Sehr guter Schirmkontakt über die Kontakthülse bei in der Kabelver- schraubung endendem Schirmgeflecht	Properties:	Excellent shield contact through the contact sleeve with the braided shield terminating in the screwed cable gland

Progress MS EMC EX



Einteiliger Dichteinsatz
nicht durchgehend isolierend

One-piece sealing insert
not overall length insulated

G	>Ø< min mm	>Ø< max mm	Ø mm	H mm	L mm	i info	Art.-Nr. Art. No.	
M8x1.25	2.5	3.5	11	15	5	1	EX1080.08.035	50
M8x1.25	3.0	4.0	11	15	5	1	EX1080.08.040	50
M10x1.5	3.0	4.0	13	16	5	1	EX1080.10.040	50
M10x1.5	4.0	6.0	13	16	5	1	EX1080.10.060	50
M12x1.5	4.5	6.0	15	20	5	-	EX1080.12.060	50
M12x1.5	6.0	7.5	15	20	5	-	EX1080.12.075	50
M16x1.5	6.0	8.0	18	23	5	-	EX1080.17.080	50
M16x1.5	8.0	10.0	18	25	5	-	EX1080.17.100	50
M20x1.5	8.0	11.0	24	25	6	-	EX1080.20.110	50
M20x1.5	12.5	14.0	24	27	6	-	EX1080.20.140	50
M25x1.5	13.0	16.0	30	30	7	-	EX1080.25.160	25
M25x1.5	17.0	19.0	30	33	7	-	EX1080.25.190	25
M32x1.5	17.0	21.0	36	32	8	-	EX1080.32.210	25
M40x1.5	24.0	28.5	46	34	8	-	EX1080.40.285	10

1 = Metrisches Regelgewinde (mit VDE Testreport)

1 = Metric coarse-pitch thread (with VDE test report)

Langes Anschlussgewinde auf Anfrage

Long entry thread available on request

AGRO Kabelverschraubungen Progress® EMV Messing mit Kontakthülse erhöhte Sicherheit Ex e II

AGRO EMC cable glands Progress® nickel-plated brass with contact sleeve increased safety Ex e II

Kurzes Anschlussgewinde Pg | Short entry thread Pg

Material: Messing vernickelt
 Dichtung: TPE
 O-Ring: FPM
 Einsatztemperatur: -60°C / +100°C
 Schutzart: IP 66 / IP 68 (bis 10 bar)
 Prüfnorm: IEC EN 60079-0 / IEC EN 60079-7 / IEC EN 60079-31
 Gas: II 2G Ex eb IIC Gb
 Staub: II 2D Ex tb IIIC Db
 Zone: Gas 1 und 2 / Staub 21 und 22
 Zertifikat: SEV 15 ATEX 0152X
 IECEx Zertifikat: IECEx SEV 15.0019X
 Eigenschaften: Sehr guter Schirmkontakt über die Kontakthülse bei in der Kabelverschraubung endendem Schirmgeflecht

Material: Nickel-plated brass
 Seal: TPE
 O-ring: FPM
 Temperature range: -60°C / +100°C
 Protection class: IP 66 / IP 68 (up to 10 bar)
 Test standard: IEC EN 60079-0 / IEC EN 60079-7 / IEC EN 60079-31
 Gas: II 2G Ex eb IIC Gb
 Dust: II 2D Ex tb IIIC Db
 Zone: Gas 1 and 2 / dust 21 and 22
 Certificate: SEV 15 ATEX 0152X
 IECEx Certificate: IECEx SEV 15.0019X
 Properties: Excellent shield contact through the contact sleeve with the braided shield terminating in the screwed cable gland

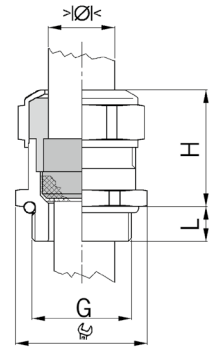

Progress MS EMC EX



Einteiliger Dichteinsatz
 nicht durchgehend isolierend

One-piece sealing insert
 not overall length insulated

G	>Ø < min mm	>Ø < max mm	Ø mm	H mm	L mm	Art.-Nr. Art. No.	
Pg 7	4.5	6.0	15	20	6	EX1080.07.060	50
Pg 7	6.0	7.5	15	20	6	EX1080.07.075	50
Pg 9	6.0	8.0	18	23	6	EX1080.09.080	50
Pg 9	8.0	10.0	18	25	6	EX1080.09.100	50
Pg 11	5.5	8.5	21	23	6	EX1080.11.085	50
Pg 11	9.5	12.0	21	23	6	EX1080.11.120	50
Pg 13	8.0	11.0	24	25	6	EX1080.13.110	50
Pg 13	12.5	14.0	24	27	6	EX1080.13.140	50
Pg 16	8.0	11.0	24	24	6	EX1080.16.110	50
Pg 16	12.5	14.0	24	27	6	EX1080.16.140	50
Pg 21	13.0	16.0	30	30	7.5	EX1080.21.160	25
Pg 21	17.0	19.0	30	33	7.5	EX1080.21.190	25
Pg 29	19.0	23.0	38	33	8	EX1080.29.230	25
Pg 29	24.0	25.5	38	32	8	EX1080.29.255	25
Pg 36	25.0	30.5	50	36	8	EX1080.36.305	10

Langes Anschlussgewinde auf Anfrage

Long entry thread available on request



1
2
3
4
5
6
7
8
9
10
11
12

Kurzes Anschlussgewinde metrisch | Short entry thread metric

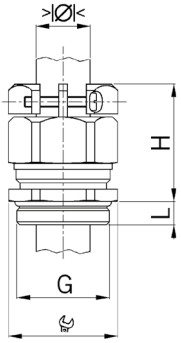

Material: Messing vernickelt
 Schrauben: Rostfreier Stahl A2
 Dichtung: TPE
 O-Ring: FPM
 Einsatztemperatur: -60°C / +100°C
 Schutzart: IP 66 / IP 68 (bis 10 bar)
 Prüfnorm: IEC EN 60079-0 / IEC EN 60079-7 / IEC EN 60079-31
 Gas: II 2G Ex eb IIC Gb
 Staub: II 2D Ex tb IIIC Db
 Zone: Gas 1 und 2 / Staub 21 und 22
 Zertifikat: SEV 15 ATEX 0151
 IECEx Zertifikat: IECEx SEV 15.0018

Material: Nickel-plated brass
 Screws: Stainless steel A2
 Seal: TPE
 O-ring: FPM
 Temperature range: -60°C / +100°C
 Protection class: IP 66 / IP 68 (up to 10 bar)
 Test standard: IEC EN 60079-0 / IEC EN 60079-7 / IEC EN 60079-31
 Gas: II 2G Ex eb IIC Gb
 Dust: II 2D Ex tb IIIC Db
 Zone: Gas 1 and 2 / dust 21 and 22
 Certificate: SEV 15 ATEX 0151
 IECEx Certificate: IECEx SEV 15.0018

Progress MS EMC KB EX



Einteiliger Dichteinsatz
 nicht durchgehend isolierend

One-piece sealing insert
 not overall length insulated

G	> Ø < min mm	> Ø < max mm	 mm	H mm	L mm	i info	Art.-Nr. Art. No.	
M12x1.5	4.5	6.0	15/16	26	5	1	EX1803.80.12.060	50
M12x1.5	6.0	7.5	15/16	26	5	1	EX1803.80.12.075	50
M16x1.5	6.0	8.0	18/19	30	5	-	EX1803.80.17.080	50
M16x1.5	8.0	10.0	18/19	30	5	-	EX1803.80.17.100	50
M20x1.5	8.0	11.0	24	31	6	-	EX1803.80.20.110	50
M20x1.5	11.0	14.0	24	31	6	-	EX1803.80.20.140	50
M25x1.5	13.0	16.0	30	35	7	-	EX1803.80.25.160	25
M25x1.5	16.0	19.0	30	35	7	-	EX1803.80.25.190	25
M32x1.5	18.0	21.0	36	40	8	-	EX1803.80.32.210	25
M32x1.5	21.0	25.0	36	40	8	-	EX1803.80.32.250	25
M40x1.5	24.0	28.5	46	44	8	-	EX1803.80.40.285	10
M40x1.5	28.5	32.0	46	44	8	-	EX1803.80.40.320	10
M50x1.5	33.0	37.0	55	49	9	-	EX1803.80.50.370	10
M50x1.5	37.0	41.0	55	49	9	-	EX1803.80.50.410	10
M63x1.5	40.0	46.0	70	55	10	-	EX1803.80.63.460	5
M63x1.5	46.0	50.0	70	55	10	-	EX1803.80.63.500	5

1 = Zertifikat SEV 15 ATEX 0152X / IECEx SEV 15.0019X

1 = Certificate SEV 15 ATEX 0152X / IECEx SEV 15.0019X

Langes Anschlussgewinde auf Anfrage

Long entry thread available on request

AGRO Kabelverschraubungen Progress® EMV Messing mit Kontakthülse und Klemmbacken erhöhte Sicherheit Ex e II

AGRO EMC cable glands Progress® nickel-plated brass with contact sleeve and clamps increased safety Ex e II

Kurzes Anschlussgewinde Pg | Short entry thread Pg

Material:	Messing vernickelt
Schrauben:	Rostfreier Stahl A2
Dichtung:	TPE
O-Ring:	FPM
Einsatztemperatur:	-60°C / +100°C
Schutzart:	IP 66 / IP 68 (bis 10 bar)
Prüfnorm:	IEC EN 60079-0 / IEC EN 60079-7 / IEC EN 60079-31
Gas:	II 2G Ex eb IIC Gb
Staub:	II 2D Ex tb IIIC Db
Zone:	Gas 1 und 2 / Staub 21 und 22
Zertifikat:	SEV 15 ATEX 0151
IECEX Zertifikat:	IECEX SEV 15.0018

Material:	Nickel-plated brass
Screws:	Stainless steel A2
Seal:	TPE
O-ring:	FPM
Temperature range:	-60°C / +100°C
Protection class:	IP 66 / IP 68 (up to 10 bar)
Test standard:	IEC EN 60079-0 / IEC EN 60079-7 / IEC EN 60079-31
Gas:	II 2G Ex eb IIC Gb
Dust:	II 2D Ex tb IIIC Db
Zone:	Gas 1 and 2 / dust 21 and 22
Certificate:	SEV 15 ATEX 0151
IECEX Certificate:	IECEX SEV 15.0018

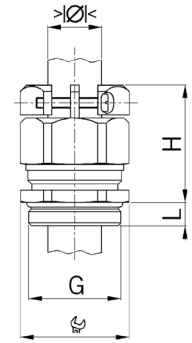

Progress MS EMC KB EX



Einteiliger Dichteinsatz
nicht durchgehend isolierend

One-piece sealing insert
not overall length insulated

G	> Ø < min mm	> Ø < max mm	 mm	H mm	L mm	i info	Art.-Nr. Art. No.	
Pg 7	4.5	6.0	15/16	26	6	1	EX1803.80.07.060	50
Pg 7	6.0	7.5	15/16	26	6	1	EX1803.80.07.075	50
Pg 9	6.0	8.0	18/19	30	6	-	EX1803.80.09.080	50
Pg 9	8.0	10.0	18/19	30	6	-	EX1803.80.09.100	50
Pg 11	5.5	8.5	21	31	6	-	EX1803.80.11.085	50
Pg 11	8.5	12.0	21	31	6	-	EX1803.80.11.120	50
Pg 13	8.0	11.0	24	31	6	-	EX1803.80.13.110	50
Pg 13	11.0	14.0	24	31	6	-	EX1803.80.13.140	50
Pg 16	8.0	11.0	24	31	6	-	EX1803.80.16.110	50
Pg 16	11.0	14.0	24	31	6	-	EX1803.80.16.140	50
Pg 21	13.0	16.0	30	35	7.5	-	EX1803.80.21.160	25
Pg 21	16.0	19.0	30	35	7.5	-	EX1803.80.21.190	25
Pg 29	19.0	23.0	38	40	8	-	EX1803.80.29.230	25
Pg 29	23.0	25.5	38	40	8	-	EX1803.80.29.255	25
Pg 36	25.0	30.5	50	47	8	-	EX1803.80.36.305	10
Pg 36	30.5	35.0	50	47	8	-	EX1803.80.36.350	10
Pg 42	33.0	37.0	55	49	10	-	EX1803.80.42.370	10
Pg 42	37.0	41.0	55	49	10	-	EX1803.80.42.410	10
Pg 48	39.0	43.0	65	51	11	-	EX1803.80.48.430	5
Pg 48	43.0	46.5	65	51	11	-	EX1803.80.48.465	5



1 = Zertifikat SEV 15 ATEX 0152X / IECEx SEV 15.0019X

1 = Certificate SEV 15 ATEX 0152X / IECEx SEV 15.0019X

Langes Anschlussgewinde auf Anfrage

Long entry thread available on request

AGRO Kombi-Schlauchverschraubungen Progress® Messing erhöhte Sicherheit Ex e II

AGRO combination conduit glands Progress® nickel-plated brass increased safety Ex e II

Kurzes Anschlussgewinde metrisch | Short entry thread metric

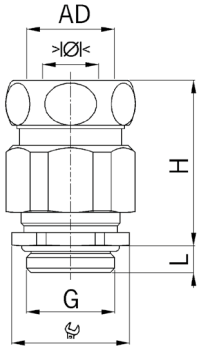

Material: Messing vernickelt
 Dichtung: TPE
 O-Ring: FPM
 Einsatztemperatur: -60°C / +100°C
 Schutzart: IP 66 / IP 68
 Prüfnorm: IEC EN 60079-0 / IEC EN 60079-7 / IEC EN 60079-31
 Gas: II 2G Ex eb IIC Gb
 Staub: II 2D Ex tb IIIC Db
 Zone: Gas 1 und 2 / Staub 21 und 22
 Zertifikat: SEV 15 ATEX 0152X
 IECEx Zertifikat: IECEx SEV 15.0019X

Material: Nickel-plated brass
 Seal: TPE
 O-ring: FPM
 Temperature range: -60°C / +100°C
 Protection class: IP 66 / IP 68
 Test standard: IEC EN 60079-0 / IEC EN 60079-7 / IEC EN 60079-31
 Gas: II 2G Ex eb IIC Gb
 Dust: II 2D Ex tb IIIC Db
 Zone: Gas 1 and 2 / dust 21 and 22
 Certificate: SEV 15 ATEX 0152X
 IECEx Certificate: IECEx SEV 15.0019X



Progress MS Kombi EX



Einteiliger Dichteinsatz
 nicht durchgehend isolierend

One-piece sealing insert
 not overall length insulated

G	AD mm	> Ø < min mm	> Ø < max mm	⌀ mm	H mm	L mm	Art.-Nr. Art. No.	
M12x1.5	10	4.0	6.5	15/17	33	5	EX1700.12.10.065	50
M16x1.5	14	4.5	6.0	18/21	38	5	EX1700.17.14.060	50
M16x1.5	14	6.0	8.0	18/21	38	5	EX1700.17.14.080	50
M16x1.5	14	8.5	10.5	18/21	38	5	EX1700.17.14.105	50
M20x1.5	17	6.5	8.0	24/25	38	6	EX1700.20.17.080	25
M20x1.5	17	9.5	11.0	24/25	38	6	EX1700.20.17.110	25
M20x1.5	19	6.5	8.0	24/27	39	6	EX1700.20.19.080	25
M20x1.5	19	9.5	11.0	24/27	39	6	EX1700.20.19.110	25
M20x1.5	19	12.0	15.0	24/27	39	6	EX1700.20.19.150	25
M20x1.5	21	6.5	8.0	24/29	39	6	EX1700.20.21.080	25
M20x1.5	21	9.5	11.0	24/29	39	6	EX1700.20.21.110	25
M20x1.5	21	12.0	15.0	24/29	39	6	EX1700.20.21.150	25
M25x1.5	21	10.5	12.5	30/29	43	7	EX1700.25.21.125	25
M25x1.5	21	13.0	16.0	30/29	43	7	EX1700.25.21.160	25
M25x1.5	27	10.5	12.5	30/36	50	7	EX1700.25.27.125	25
M25x1.5	27	13.0	16.0	30/36	50	7	EX1700.25.27.160	25
M25x1.5	27	17.0	20.5	30/36	50	7	EX1700.25.27.205	25
M32x1.5	27	19.0	21.0	36/36	52	8	EX1700.32.27.210	25
M40x1.5	36	25.0	28.5	45/45	56	8	EX1700.40.36.285	10
M50x1.5	45	35.0	37.0	55/54	60	9	EX1700.50.45.370	10
M63x1.5	56	44.0	46.0	70/66	67	10	EX1700.63.56.460	5

Langes Anschlussgewinde auf Anfrage

Long entry thread available on request

Je nach Schlauchtyp muss die passende Stabilisierungshülse separat bestellt werden.

Depending on the type of conduit, the stabilising bush must be ordered separately.

Achtung: Es dürfen nur metallische oder metallisch umflochtene Schutzschläuche verwendet werden!

Warning: Only metallic conduits or conduits with metallic braiding may be applied!

AGRO Kabelverschraubungen Progress® Kunststoff GFK erhöhte Sicherheit Ex e II

AGRO synthetic cable glands Progress® GFK increased safety Ex e II

Anschlussgewinde metrisch | Entry thread metric

Material: Polyamid glasfaserverstärkt
 Eigenschaften: halogenfrei
 Dichtung: TPE / NBR
 Einsatztemperatur: -20°C / +85°C
 Schutzart: IP 66 / IP 68
 Prüfnorm: IEC EN 60079-0 / IEC EN 60079-7 / IEC EN 60079-31
 Gas: II 2G Ex eb IIC Gb
 Staub: II 2D Ex tb IIIC Db
 Zone: Gas 1 und 2 / Staub 21 und 22
 Zertifikat: SEV 15 ATEX 0152X
 IECEx Zertifikat: IECEx SEV 15.0019X

Material: Polyamide glass fiber reinforced
 Properties: halogen-free
 Seal: TPE / NBR
 Temperature range: -20°C / +85°C
 Protection class: IP 66 / IP 68
 Test standard: IEC EN 60079-0 / IEC EN 60079-7 / IEC EN 60079-31
 Gas: II 2G Ex eb IIC Gb
 Dust: II 2D Ex tb IIIC Db
 Zone: Gas 1 and 2 / dust 21 and 22
 Certificate: SEV 15 ATEX 0152X
 IECEx Certificate: IECEx SEV 15.0019X

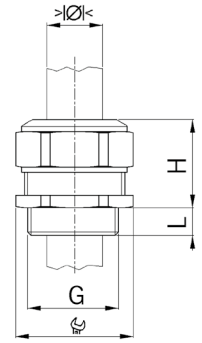

Progress GFK EX



Hellgrau RAL 7035 Light grey RAL 7035
 Einteiliger Dichteinsatz One-piece sealing insert

G	>Ø< min mm	>Ø< max mm	Ø mm	H mm	L mm	i info	Art.-Nr. Art. No.	
M16x1.5	4.5	6.0	21	26	12	-	EX1571.17.060	50
M16x1.5	6.0	8.0	21	26	12	-	EX1571.17.080	50
M20x1.5	6.0	8.0	27	28	13	-	EX1571.20.080	50
M20x1.5	8.0	11.0	27	28	13	-	EX1571.20.110	50
M25x1.5	9.5	12.5	34	33	13	-	EX1571.25.125	25
M25x1.5	12.5	16.0	34	33	13	-	EX1571.25.160	25
M25x1.5	16.0	19.0	34	33	13	-	EX1571.25.190	25
M25x1.5	19.0	20.5	34	33	13	-	EX1571.25.205	25
M32x1.5	20.0	21.0	41	35	15	-	EX1571.32.210	25
M32x1.5	21.0	22.0	41	35	15	3	EX1571.32.220	25
M32x1.5	22.0	23.0	41	35	15	3	EX1571.32.230	25
M32x1.5	23.0	25.5	41	35	15	-	EX1571.32.255	25
M40x1.5	25.5	27.0	50	40	15	3	EX1571.40.270	10
M40x1.5	27.0	28.5	50	40	15	-	EX1571.40.285	10
M40x1.5	28.5	30.0	50	40	15	3	EX1571.40.300	10
M40x1.5	30.0	33.0	50	40	15	-	EX1571.40.330	10
M50x1.5	33.0	35.0	60	42	16	3	EX1571.50.350	10
M50x1.5	35.0	37.0	60	42	16	-	EX1571.50.370	10
M50x1.5	37.0	39.0	60	42	16	3	EX1571.50.390	10
M50x1.5	39.0	42.0	60	42	16	-	EX1571.50.420	10
M63x1.5	42.0	44.0	75	48	16	3	EX1571.63.440	5
M63x1.5	44.0	46.0	75	48	16	-	EX1571.63.460	5
M63x1.5	46.0	48.0	75	48	16	3	EX1571.63.480	5
M63x1.5	48.0	52.0	75	48	16	-	EX1571.63.520	5

3 = Material Dichteinsatz NBR

3 = Material sealing insert NBR



1
2
3
4
5
6
7
8
9
10
11
12

AGRO Kabelverschraubungen Progress® Kunststoff GFK erhöhte Sicherheit Ex e II

AGRO synthetic cable glands Progress® GFK increased safety Ex e II

Anschlussgewinde metrisch | Entry thread metric

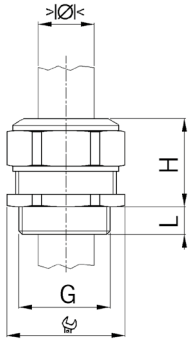

Material: Polyamid glasfaserverstärkt
 Eigenschaften: halogenfrei
 Dichtung: TPE / NBR
 Einsatztemperatur: -20°C / +85°C
 Schutzart: IP 66 / IP 68
 Prüfnorm: IEC EN 60079-0 / IEC EN 60079-7 / IEC EN 60079-31
 Gas: II 2G Ex eb IIC Gb
 Staub: II 2D Ex tb IIIC Db
 Zone: Gas 1 und 2 / Staub 21 und 22
 Zertifikat: SEV 15 ATEX 0152X
 IECEx Zertifikat: IECEx SEV 15.0019X

Material: Polyamide glass fiber reinforced
 Properties: halogen-free
 Seal: TPE / NBR
 Temperature range: -20°C / +85°C
 Protection class: IP 66 / IP 68
 Test standard: IEC EN 60079-0 / IEC EN 60079-7 / IEC EN 60079-31
 Gas: II 2G Ex eb IIC Gb
 Dust: II 2D Ex tb IIIC Db
 Zone: Gas 1 and 2 / dust 21 and 22
 Certificate: SEV 15 ATEX 0152X
 IECEx Certificate: IECEx SEV 15.0019X



Progress GFK EX



Schwarz RAL 9005
 Einteiliger Dichteinsatz

Black RAL 9005
 One-piece sealing insert

G	> Ø < min mm	> Ø < max mm	 mm	H mm	L mm	i info	Art.-Nr. Art. No.	
M16x1.5	4.5	6.0	21	26	12	-	EX1540.17.060	50
M16x1.5	6.0	8.0	21	26	12	-	EX1540.17.080	50
M20x1.5	6.0	8.0	27	28	13	-	EX1540.20.080	50
M20x1.5	8.0	11.0	27	28	13	-	EX1540.20.110	50
M25x1.5	9.5	12.5	34	33	13	-	EX1540.25.125	25
M25x1.5	12.5	16.0	34	33	13	-	EX1540.25.160	25
M25x1.5	16.0	19.0	34	33	13	-	EX1540.25.190	25
M25x1.5	19.0	20.5	34	33	13	-	EX1540.25.205	25
M32x1.5	20.0	21.0	41	35	15	-	EX1540.32.210	25
M32x1.5	21.0	22.0	41	35	15	3	EX1540.32.220	25
M32x1.5	22.0	23.0	41	35	15	3	EX1540.32.230	25
M32x1.5	23.0	25.5	41	35	15	-	EX1540.32.255	25
M40x1.5	25.5	27.0	50	40	15	3	EX1540.40.270	10
M40x1.5	27.0	28.5	50	40	15	-	EX1540.40.285	10
M40x1.5	28.5	30.0	50	40	15	3	EX1540.40.300	10
M40x1.5	30.0	33.0	50	40	15	-	EX1540.40.330	10
M50x1.5	33.0	35.0	60	42	16	3	EX1540.50.350	10
M50x1.5	35.0	37.0	60	42	16	-	EX1540.50.370	10
M50x1.5	37.0	39.0	60	42	16	3	EX1540.50.390	10
M50x1.5	39.0	42.0	60	42	16	-	EX1540.50.420	10
M63x1.5	42.0	44.0	75	48	16	3	EX1540.63.440	5
M63x1.5	44.0	46.0	75	48	16	-	EX1540.63.460	5
M63x1.5	46.0	48.0	75	48	16	3	EX1540.63.480	5
M63x1.5	48.0	52.0	75	48	16	-	EX1540.63.520	5

3 = Material Dichteinsatz NBR

3 = Material sealing insert NBR

AGRO Kabelverschraubungen Progress® Kunststoff GFK erhöhte Sicherheit Ex e II

AGRO synthetic cable glands Progress® GFK increased safety Ex e II

Anschlussgewinde Pg | Entry thread Pg

Material: Polyamid glasfaserverstärkt
 Eigenschaften: halogenfrei
 Dichtung: TPE / NBR
 Einsatztemperatur: -20°C / +85°C
 Schutzart: IP 66 / IP 68
 Prüfnorm: IEC EN 60079-0 / IEC EN 60079-7 / IEC EN 60079-31
 Gas: II 2G Ex eb IIC Gb
 Staub: II 2D Ex tb IIIC Db
 Zone: Gas 1 und 2 / Staub 21 und 22
 Zertifikat: SEV 15 ATEX 0152X
 IECEx Zertifikat: IECEx SEV 15.0019X

Material: Polyamide glass fiber reinforced
 Properties: halogen-free
 Seal: TPE / NBR
 Temperature range: -20°C / +85°C
 Protection class: IP 66 / IP 68
 Test standard: IEC EN 60079-0 / IEC EN 60079-7 / IEC EN 60079-31
 Gas: II 2G Ex eb IIC Gb
 Dust: II 2D Ex tb IIIC Db
 Zone: Gas 1 and 2 / dust 21 and 22
 Certificate: SEV 15 ATEX 0152X
 IECEx Certificate: IECEx SEV 15.0019X

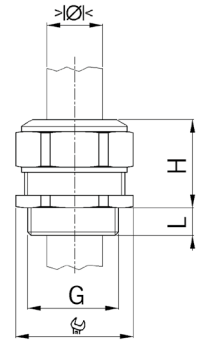

Progress GFK EX



Hellgrau RAL 7035

Light grey RAL 7035

Einteiliger Dichteinsatz

One-piece sealing insert

G	>Ø< min mm	>Ø< max mm	 mm	H mm	L mm	i info	Art.-Nr. Art. No.	
Pg 9	4.5	6.0	21	26	12	-	EX1571.09.060	50
Pg 9	6.0	8.0	21	26	12	-	EX1571.09.080	50
Pg 11	4.0	5.5	24	28	12	-	EX1571.11.055	50
Pg 11	5.5	8.5	24	28	12	-	EX1571.11.085	50
Pg 13	6.0	8.0	27	28	13	-	EX1571.13.080	50
Pg 13	8.0	11.0	27	28	13	-	EX1571.13.110	50
Pg 16	6.0	8.0	27	28	13	-	EX1571.16.080	50
Pg 16	8.0	11.0	27	28	13	-	EX1571.16.110	50
Pg 21	9.5	12.5	34	33	13	-	EX1571.21.125	25
Pg 21	12.5	16.0	34	33	13	-	EX1571.21.160	25
Pg 21	16.0	19.0	34	33	13	-	EX1571.21.190	25
Pg 21	19.0	20.5	34	33	13	-	EX1571.21.205	25
Pg 29	19.5	21.0	41	36	13	3	EX1571.29.210	25
Pg 29	21.0	23.0	41	36	13	-	EX1571.29.230	25
Pg 29	23.0	25.0	41	36	13	3	EX1571.29.250	25
Pg 29	25.0	27.5	41	36	13	-	EX1571.29.275	25
Pg 36	27.0	28.5	55	42	16	3	EX1571.36.285	10
Pg 36	28.5	30.5	55	42	16	-	EX1571.36.305	10
Pg 36	30.5	32.5	55	42	16	3	EX1571.36.325	10
Pg 36	32.5	35.0	55	42	16	-	EX1571.36.350	10
Pg 42	33.0	35.0	60	42	16	3	EX1571.42.350	10
Pg 42	35.0	37.0	60	42	16	-	EX1571.42.370	10
Pg 42	37.0	39.0	60	42	16	3	EX1571.42.390	10
Pg 42	39.0	42.0	60	42	16	-	EX1571.42.420	10
Pg 48	41.0	43.0	70	46	16	-	EX1571.48.430	5
Pg 48	43.0	45.0	70	46	16	3	EX1571.48.450	5
Pg 48	45.0	47.0	70	46	16	3	EX1571.48.470	25
Pg 48	47.0	49.0	70	46	16	-	EX1571.48.490	5

3 = Material Dichteinsatz NBR

3 = Material sealing insert NBR



AGRO Kabelverschraubungen Progress® Kunststoff GFK erhöhte Sicherheit Ex e II

AGRO synthetic cable glands Progress® GFK increased safety Ex e II

Anschlussgewinde Pg | Entry thread Pg

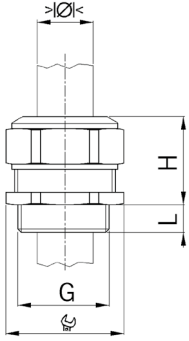

Material: Polyamid glasfaserverstärkt
 Eigenschaften: halogenfrei
 Dichtung: TPE / NBR
 Einsatztemperatur: -20°C / +85°C
 Schutzart: IP 66 / IP 68
 Prüfnorm: IEC EN 60079-0 / IEC EN 60079-7 / IEC EN 60079-31
 Gas: II 2G Ex eb IIC Gb
 Staub: II 2D Ex tb IIIC Db
 Zone: Gas 1 und 2 / Staub 21 und 22
 Zertifikat: SEV 15 ATEX 0152X
 IECEx Zertifikat: IECEx SEV 15.0019X

Material: Polyamide glass fiber reinforced
 Properties: halogen-free
 Seal: TPE / NBR
 Temperature range: -20°C / +85°C
 Protection class: IP 66 / IP 68
 Test standard: IEC EN 60079-0 / IEC EN 60079-7 / IEC EN 60079-31
 Gas: II 2G Ex eb IIC Gb
 Dust: II 2D Ex tb IIIC Db
 Zone: Gas 1 and 2 / dust 21 and 22
 Certificate: SEV 15 ATEX 0152X
 IECEx Certificate: IECEx SEV 15.0019X



Progress GFK EX



Schwarz RAL 9005

Black RAL 9005

Einteiliger Dichteinsatz

One-piece sealing insert

G	> Ø < min mm	> Ø < max mm	mm	H mm	L mm	i info	Art.-Nr. Art. No.	
Pg 9	4.5	6.0	21	26	12	-	EX1540.09.060	50
Pg 9	6.0	8.0	21	26	12	-	EX1540.09.080	50
Pg 11	4.0	5.5	24	28	12	-	EX1540.11.055	50
Pg 11	5.5	8.5	24	28	12	-	EX1540.11.085	50
Pg 13	6.0	8.0	27	28	13	-	EX1540.13.080	50
Pg 13	8.0	11.0	27	28	13	-	EX1540.13.110	50
Pg 16	6.0	8.0	27	28	13	-	EX1540.16.080	50
Pg 16	8.0	11.0	27	28	13	-	EX1540.16.110	50
Pg 21	9.5	12.5	34	33	13	-	EX1540.21.125	25
Pg 21	12.5	16.0	34	33	13	-	EX1540.21.160	25
Pg 21	16.0	19.0	34	33	13	-	EX1540.21.190	25
Pg 21	19.0	20.5	34	33	13	-	EX1540.21.205	25
Pg 29	19.5	21.0	41	36	13	3	EX1540.29.210	25
Pg 29	21.0	23.0	41	36	13	-	EX1540.29.230	25
Pg 29	23.0	25.0	41	36	13	3	EX1540.29.250	25
Pg 29	25.0	27.5	41	36	13	-	EX1540.29.275	25
Pg 36	27.0	28.5	55	42	16	3	EX1540.36.285	10
Pg 36	28.5	30.5	55	42	16	-	EX1540.36.305	10
Pg 36	30.5	32.5	55	42	16	3	EX1540.36.325	10
Pg 36	32.5	35.0	55	42	16	-	EX1540.36.350	10
Pg 42	33.0	35.0	60	42	16	3	EX1540.42.350	10
Pg 42	35.0	37.0	60	42	16	-	EX1540.42.370	10
Pg 42	37.0	39.0	60	42	16	3	EX1540.42.390	10
Pg 42	39.0	42.0	60	42	16	-	EX1540.42.420	10
Pg 48	41.0	43.0	70	46	16	-	EX1540.48.430	5
Pg 48	43.0	45.0	70	46	16	3	EX1540.48.450	5
Pg 48	45.0	47.0	70	46	16	3	EX1540.48.470	5
Pg 48	47.0	49.0	70	46	16	-	EX1540.48.490	5

3 = Material Dichteinsatz NBR

3 = Material sealing insert NBR

AGRO Kabelverschraubungen Progress® Kunststoff GFK erhöhte Sicherheit Ex e II für mehrere Kabel AGRO synthetic cable glands Progress® GFK for increased safety Ex e II with sealing insert for multiple cables

Anschlussgewinde metrisch | Entry thread metric

Material: Polyamid glasfaserverstärkt
Eigenschaften: halogenfrei
Dichtung: TPE / NBR
Einsatztemperatur: -20°C / +85°C
Schutzart: IP 66 / IP 68
Prüfnorm: IEC EN 60079-0 / IEC EN 60079-7 / IEC EN 60079-31
Gas: II 2G Ex eb IIC Gb
Staub: II 2D Ex tb IIIC Db
Zone: Gas 1 und 2 / Staub 21 und 22
Zertifikat: SEV 15 ATEX 0152X
IECEX Zertifikat: IECEX SEV 15.0019X

Material: Polyamide glass fiber reinforced
Properties: halogen-free
Seal: TPE / NBR
Temperature range: -20°C / +85°C
Protection class: IP 66 / IP 68
Test standard: IEC EN 60079-0 / IEC EN 60079-7 / IEC EN 60079-31
Gas: II 2G Ex eb IIC Gb
Dust: II 2D Ex tb IIIC Db
Zone: Gas 1 and 2 / dust 21 and 22
Certificate: SEV 15 ATEX 0152X
IECEX Certificate: IECEX SEV 15.0019X

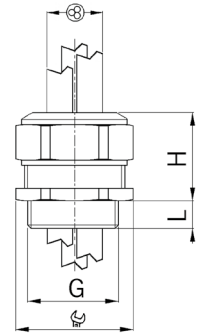

Progress GFK Multi EX



Hellgrau RAL 7035 Einteiliger Dichteinsatz		Light grey RAL 7035 One-piece sealing insert							
G	>Ø< min mm	>Ø< max mm	⊗	Ⓜ mm	H mm	L mm	i info	Art.-Nr. Art. No.	📦
M16x1.5	1.0	1.5	4	21	26	12	3	EX1571.17.4.015	50
M16x1.5	2.0	3.0	2	21	26	12	-	EX1571.17.2.030	50
M20x1.5	2.5	3.0	6	27	28	13	-	EX1571.20.6.030	50
M20x1.5	3.5	5.0	2	27	28	13	-	EX1571.20.2.050	50
M25x1.5	5.0	6.0	6	34	33	13	-	EX1571.25.6.060	25
M25x1.5	5.5	7.0	4	34	33	13	-	EX1571.25.4.070	25
M25x1.5	7.5	9.0	3	34	33	13	-	EX1571.25.3.090	25
M25x1.5	8.0	10.0	2	34	33	13	-	EX1571.25.2.100	25
M32x1.5	6.0	7.0	6	41	35	15	-	EX1571.32.6.070	25
M32x1.5	7.5	9.0	4	41	35	15	-	EX1571.32.4.090	25
M40x1.5	8.0	9.0	7	50	40	15	3	EX1571.40.7.090	10
M40x1.5	14.0	15.0	2	50	40	15	3	EX1571.40.2.150	10
M50x1.5	9.0	10.0	4	60	42	16	3	EX1571.50.4.100	10
M63x1.5	11.0	12.0	6	75	48	16	3	EX1571.63.6.120	5
M63x1.5	17.0	18.0	3	75	48	16	3	EX1571.63.3.180	5

3 = Material Dichteinsatz NBR 3 = Material sealing insert NBR



Progress GFK Multi EX



Schwarz RAL 9005 Einteiliger Dichteinsatz		Black RAL 9005 One-piece sealing insert							
G	>Ø< min mm	>Ø< max mm	⊗	Ⓜ mm	H mm	L mm	i info	Art.-Nr. Art. No.	📦
M16x1.5	1.0	1.5	4	21	26	12	3	EX1540.17.4.015	50
M16x1.5	2.0	3.0	2	21	26	12	-	EX1540.17.2.030	50
M20x1.5	2.5	3.0	6	27	28	13	-	EX1540.20.6.030	50
M20x1.5	3.5	5.0	2	27	28	13	-	EX1540.20.2.050	50
M25x1.5	5.0	6.0	6	34	33	13	-	EX1540.25.6.060	25
M25x1.5	5.5	7.0	4	34	33	13	-	EX1540.25.4.070	25
M25x1.5	7.5	9.0	3	34	33	13	-	EX1540.25.3.090	25
M25x1.5	8.0	10.0	2	34	33	13	-	EX1540.25.2.100	25
M32x1.5	6.0	7.0	6	41	33	13	-	EX1540.32.6.070	25
M32x1.5	7.5	9.0	4	41	35	15	-	EX1540.32.4.090	25
M40x1.5	8.0	9.0	7	50	40	15	3	EX1540.40.7.090	10
M40x1.5	14.0	15.0	2	50	40	15	3	EX1540.40.2.150	10
M50x1.5	9.0	10.0	4	60	42	16	3	EX1540.50.4.100	10
M63x1.5	11.0	12.0	6	75	48	16	3	EX1540.63.6.120	5
M63x1.5	17.0	18.0	3	75	48	16	3	EX1540.63.3.180	5

3 = Material Dichteinsatz NBR 3 = Material sealing insert NBR



Anschlussgewinde Pg | Entry thread Pg

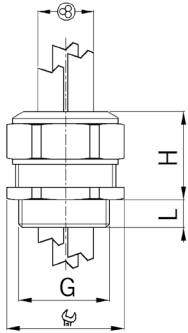

Material: Polyamid glasfaserverstärkt
 Eigenschaften: halogenfrei
 Dichtung: TPE / NBR
 Einsatztemperatur: -20°C / +85°C
 Schutzart: IP 66 / IP 68
 Prüfnorm: IEC EN 60079-0 / IEC EN 60079-7 / IEC EN 60079-31
 Gas: II 2G Ex eb IIC Gb
 Staub: II 2D Ex tb IIIC Db
 Zone: Gas 1 und 2 / Staub 21 und 22
 Zertifikat: SEV 15 ATEX 0152X
 IECEx Zertifikat: IECEx SEV 15.0019X

Material: Polyamide glass fiber reinforced
 Properties: halogen-free
 Seal: TPE / NBR
 Temperature range: -20°C / +85°C
 Protection class: IP 66 / IP 68
 Test standard: IEC EN 60079-0 / IEC EN 60079-7 / IEC EN 60079-31
 Gas: II 2G Ex eb IIC Gb
 Dust: II 2D Ex tb IIIC Db
 Zone: Gas 1 and 2 / dust 21 and 22
 Certificate: SEV 15 ATEX 0152X
 IECEx Certificate: IECEx SEV 15.0019X

Progress GFK Multi EX



Hellgrau RAL 7035
 Einteiliger Dichteinsatz
 Light grey RAL 7035
 One-piece sealing insert

G	>∅<	>∅<	⊗	mm	H	L	i	Art.-Nr. Art. No.	☐
	min mm	max mm		mm	mm	mm	info		
Pg 9	1.0	1.5	4	21	26	12	3	EX1571.09.4.015	50
Pg 9	2.0	3.0	2	21	26	12	-	EX1571.09.2.030	50
Pg 11	3.5	5.0	2	24	28	12	-	EX1571.11.2.050	50
Pg 11	2.0	3.0	3	24	28	12	3	EX1571.11.3.030	50
Pg 13	2.5	4.0	3	27	28	13	3	EX1571.13.3.040	50
Pg 13	3.5	5.0	2	27	28	13	-	EX1571.13.2.050	50
Pg 16	2.5	3.0	6	27	28	13	-	EX1571.16.6.030	50
Pg 16	4.5	6.0	3	27	28	13	-	EX1571.16.3.060	50
Pg 21	5.5	7.0	4	34	33	13	-	EX1571.21.4.070	25
Pg 21	7.5	9.0	3	34	33	13	-	EX1571.21.3.090	25
Pg 29	5.5	6.5	6	41	36	13	3	EX1571.29.6.065	25
Pg 29	8.0	9.0	3	41	36	13	3	EX1571.29.3.090	25
Pg 36	9.0	10.0	4	55	42	16	3	EX1571.36.4.100	10
Pg 36	14.0	15.0	2	55	42	16	3	EX1571.36.2.150	10
Pg 42	9.0	10.0	4	60	42	16	3	EX1571.42.4.100	10
Pg 48	11.0	12.0	6	70	46	16	3	EX1571.48.6.120	5
Pg 48	17.0	18.0	3	70	46	16	3	EX1571.48.3.180	5

3 = Material Dichteinsatz NBR

3 = Material sealing insert NBR

Progress GFK Multi EX



Schwarz RAL 9005
 Einteiliger Dichteinsatz
 Black RAL 9005
 One-piece sealing insert

G	>∅<	>∅<	⊗	mm	H	L	i	Art.-Nr. Art. No.	☐
	min mm	max mm		mm	mm	mm	info		
Pg 9	1.0	1.5	4	21	26	12	3	EX1540.09.4.015	50
Pg 9	2.0	3.0	2	21	26	12	-	EX1540.09.2.030	50
Pg 11	2.0	3.0	3	24	28	12	3	EX1540.11.3.030	50
Pg 11	3.5	5.0	2	24	28	12	-	EX1540.11.2.050	50
Pg 13	2.5	4.0	3	27	28	13	3	EX1540.13.3.040	50
Pg 13	3.5	5.0	2	27	28	13	-	EX1540.13.2.050	50
Pg 16	2.5	3.0	6	27	28	13	-	EX1540.16.6.030	50
Pg 16	4.5	6.0	3	27	28	13	-	EX1540.16.3.060	50
Pg 21	5.5	7.0	4	34	33	13	-	EX1540.21.4.070	25
Pg 21	7.5	9.0	3	34	33	13	-	EX1540.21.3.090	25
Pg 29	5.5	6.5	6	41	36	13	3	EX1540.29.6.065	25
Pg 29	8.0	9.0	3	41	36	13	3	EX1540.29.3.090	25
Pg 36	14.0	15.0	2	55	42	16	3	EX1540.36.2.150	10
Pg 36	9.0	10.0	4	55	42	16	3	EX1540.36.4.100	10
Pg 42	9.0	10.0	4	60	42	16	3	EX1540.42.4.100	10
Pg 48	11.0	12.0	6	70	46	16	3	EX1540.48.6.120	5
Pg 48	17.0	18.0	3	70	46	16	3	EX1540.48.3.180	5

3 = Material Dichteinsatz NBR

3 = Material sealing insert NBR

AGRO Kabelverschraubungen Progress® Kunststoff GFK erhöhte Sicherheit Ex e II und Eigensicherheit Ex i II

AGRO synthetic cable glands Progress® GFK increased safety Ex e II and intrinsic safety Ex i II

Anschlussgewinde metrisch | Filet de raccordement métrique

Material: Polyamid glasfaserverstärkt
 Eigenschaften: halogenfrei
 Dichtung: TPE / NBR
 Einsatztemperatur: -20°C / +85°C
 Schutzart: IP 68
 Prüfnorm: IEC EN 60079-0 / IEC EN 60079-7 / IEC EN 60079-31
 Gas: II 2G Ex eb IIC Gb
 Staub: II 2D Ex tb IIIC Db
 Eigensicherheit Gas: II 2G Ex ia IIC Ga
 Eigensicherheit Staub: II 2D Ex ia IIIC Da
 Zone: Gas 0, 1 und 2 / Staub 20, 21 und 22
 Zertifikat: SEV 15 ATEX 0152X
 IECEx Zertifikat: IECEx SEV 15.0019X

Material: Polyamide glass fiber reinforced
 Properties: halogen-free
 Seal: TPE / NBR
 Temperature range: -20°C / +85°C
 Protection class: IP 66 / IP 68 (up to 10 bar)
 Test standard: IEC EN 60079-0 / IEC EN 60079-7 / IEC EN 60079-31
 Gas: II 2G Ex eb IIC Gb
 Dust: II 2D Ex tb IIIC Db
 Intrinsic safety gas: II 2G Ex ia IIC Ga
 Intrinsic safety dust: II 2D Ex ia IIIC Da
 Zone: Gas 0, 1 and 2 / dust 20, 21 and 22
 Certificate: SEV 15 ATEX 0152X
 IECEx Certificate: IECEx SEV 15.0019X

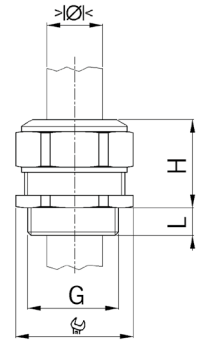

Progress GFK EX



Schwarz / Lichtblau RAL 5012
 Einteiliger Dichteinsatz

Black / light blue RAL 5012
 One-piece sealing insert

G	>Ø< min mm	>Ø< max mm	 mm	H mm	L mm	i info	Art.-Nr. Art. No.	
M16x1.5	4.5	6.0	21	26	12	-	EX1530.17.060	50
M16x1.5	6.0	8.0	21	26	12	-	EX1530.17.080	50
M20x1.5	6.0	8.0	27	28	13	-	EX1530.20.080	50
M20x1.5	8.0	11.0	27	28	13	-	EX1530.20.110	50
M25x1.5	9.5	12.5	34	33	13	-	EX1530.25.125	25
M25x1.5	12.5	16.0	34	33	13	-	EX1530.25.160	25
M25x1.5	16.0	19.0	34	33	13	-	EX1530.25.190	25
M25x1.5	19.0	20.5	34	33	13	-	EX1530.25.205	25
M32x1.5	20.0	21.0	41	35	15	-	EX1530.32.210	25
M32x1.5	21.0	22.0	41	35	15	3	EX1530.32.220	25
M32x1.5	22.0	23.0	41	35	15	3	EX1530.32.230	25
M32x1.5	23.0	25.5	41	35	15	-	EX1530.32.255	25
M40x1.5	25.5	27.0	50	40	15	3	EX1530.40.270	10
M40x1.5	27.0	28.5	50	40	15	-	EX1530.40.285	10
M40x1.5	28.5	30.0	50	40	15	3	EX1530.40.300	10
M40x1.5	30.0	33.0	50	40	15	-	EX1530.40.330	10
M50x1.5	33.0	35.0	60	42	16	3	EX1530.50.350	10
M50x1.5	35.0	37.0	60	42	16	-	EX1530.50.370	10
M50x1.5	37.0	39.0	60	42	16	3	EX1530.50.390	10
M50x1.5	39.0	42.0	60	42	16	-	EX1530.50.420	10
M63x1.5	42.0	44.0	75	48	16	3	EX1530.63.440	5
M63x1.5	44.0	46.0	75	48	16	-	EX1530.63.460	5
M63x1.5	46.0	48.0	75	48	16	3	EX1530.63.480	5
M63x1.5	48.0	52.0	75	48	16	-	EX1530.63.520	5



3 = Material Dichteinsatz NBR

3 = Material sealing insert NBR

Auf Anfrage lieferbar:

Available on request:

Für mehrere Kabel

For installation of multiple cables

Anschlussgewinde Pg | Entry thread Pg

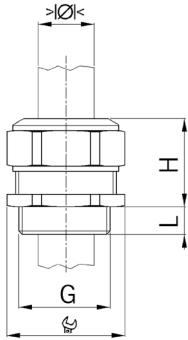

Material: Polyamid glasfaserverstärkt
 Eigenschaften: halogenfrei
 Dichtung: TPE / NBR
 Einsatztemperatur: -20°C / +85°C
 Schutzart: IP 68
 Prüfnorm: IEC EN 60079-0 / IEC EN 60079-7 / IEC EN 60079-31
 Gas: II 2G Ex eb IIC Gb
 Staub: II 2D Ex tb IIIC Db
 Eigensicherheit Gas: II 2G Ex ia IIC Ga
 Eigensicherheit Staub: II 2D Ex ia IIIC Da
 Zone: Gas 0, 1 und 2 / Staub 20, 21 und 22
 Zertifikat: SEV 15 ATEX 0152X
 IECEx Zertifikat: IECEx SEV 15.0019X

Material: Polyamide glass fiber reinforced
 Properties: halogen-free
 Seal: TPE / NBR
 Temperature range: -20°C / +85°C
 Protection class: IP 68
 Test standard: IEC EN 60079-0 / IEC EN 60079-7 / IEC EN 60079-31
 Gas: II 2G Ex eb IIC Gb
 Dust: II 2D Ex tb IIIC Db
 Intrinsic safety gas: II 2G Ex ia IIC Ga
 Intrinsic safety dust: II 2D Ex ia IIIC Da
 Zone: Gas 0, 1 and 2 / dust 20, 21 and 22
 Certificate: SEV 15 ATEX 0152X
 IECEx Certificate: IECEx SEV 15.0019X



Progress GFK EX



Schwarz / Lichtblau RAL 5012
 Einteiliger Dichteinsatz

Black / light blue RAL 5012

One-piece sealing insert

G	>math>\varnothing</math> min mm	>math>\varnothing</math> max mm	>math>\varnothing</math> mm	H mm	L mm	i info	Art.-Nr. Art. No.	
Pg 9	4.5	6.0	21	26	12	-	EX1530.09.060	50
Pg 9	6.0	8.0	21	26	12	-	EX1530.09.080	50
Pg 11	4.0	5.5	24	28	12	-	EX1530.11.055	50
Pg 11	5.5	8.5	24	28	12	-	EX1530.11.085	50
Pg 13	6.0	8.0	27	28	13	-	EX1530.13.080	50
Pg 13	8.0	11.0	27	28	13	-	EX1530.13.110	50
Pg 16	6.0	8.0	27	28	13	-	EX1530.16.080	50
Pg 16	8.0	11.0	27	28	13	-	EX1530.16.110	50
Pg 21	9.5	12.5	34	33	13	-	EX1530.21.125	25
Pg 21	12.5	16.0	34	33	13	-	EX1530.21.160	25
Pg 21	16.0	19.0	34	33	13	-	EX1530.21.190	25
Pg 21	19.0	20.5	34	33	13	-	EX1530.21.205	25
Pg 29	19.5	21.0	41	36	13	3	EX1530.29.210	25
Pg 29	21.0	23.0	41	36	13	-	EX1530.29.230	25
Pg 29	23.0	25.0	41	36	13	3	EX1530.29.250	25
Pg 29	25.0	27.5	41	36	13	-	EX1530.29.275	25
Pg 36	27.0	28.5	55	42	16	3	EX1530.36.285	10
Pg 36	28.5	30.5	55	42	16	-	EX1530.36.305	10
Pg 36	30.5	32.5	55	42	16	3	EX1530.36.325	10
Pg 36	32.5	35.0	55	42	16	-	EX1530.36.350	10
Pg 42	33.0	35.0	60	42	16	3	EX1530.42.350	10
Pg 42	35.0	37.0	60	42	16	-	EX1530.42.370	10
Pg 42	37.0	39.0	60	42	16	3	EX1530.42.390	10
Pg 42	39.0	42.0	60	42	16	-	EX1530.42.420	10
Pg 48	41.0	43.0	70	46	16	-	EX1530.48.430	5
Pg 48	43.0	45.0	70	46	16	3	EX1530.48.450	5
Pg 48	45.0	47.0	70	46	16	3	EX1530.48.470	5
Pg 48	47.0	49.0	70	46	16	-	EX1530.48.490	5

3 = Material Dichteinsatz NBR

3 = Material sealing insert NBR

Auf Anfrage lieferbar:

Available on request:

Für mehrere Kabel

For installation of multiple cables

Zubehör zu Kabelverschraubungen Messing und Kunststoff erhöhte Sicherheit Ex e II

Accessories for cable glands brass and synthetic for increased safety Ex e II

Anschlussgewinde metrisch | Entry thread metric

Druckausgleichselement mit Membrane erhöhte Sicherheit Ex e II

Material:	Messing vernickelt
Membrane:	PES Polyethersulfon
O-Ring:	FPM
Einsatztemperatur:	-60°C / +100°C
Schutzart:	Produkt-Eigenschaften
Prüfnorm:	IEC EN 60079-0 / IEC EN 60079-7 / IEC EN 60079-31
Gas:	II 2G Ex eb IIC Gb
Staub:	II 2D Ex tb IIIC Db
Zone:	Gas 1 und 2 / Staub 21 und 22
Zertifikat:	SEV 16 ATEX 0143
IECEx Zertifikat:	IECEx SEV 16.0010

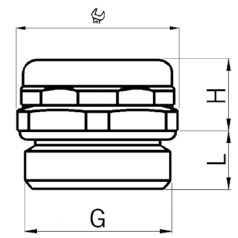

Pressure balance element with membrane increased safety Ex e II

Material:	Nickel-plated brass
Membrane:	PES polyethersulfone
O-ring:	FPM
Temperature range:	-60°C / +100°C
Protection class:	Produkt-Eigenschaften
Test standard:	IEC EN 60079-0 / IEC EN 60079-7 / IEC EN 60079-31
Gas:	II 2G Ex eb IIC Gb
Dust:	II 2D Ex tb IIIC Db
Zone:	Gas 1 and 2 / dust 21 and 22
Certificate:	SEV 16 ATEX 0143
IECEx Certificate:	IECEx SEV 16.0010



EX DAE



mit Membrane mit O-Ring				with membrane with O-ring	
G	 mm	H mm	L mm	Art.-Nr. Art. No.	
M12x1.5	18	9.5	8	EX2450.12.34	25
M16x1.5	18	9.5	8	EX2450.17.34	20
M20x1.5	22	10.0	8	EX2450.20.34	20
Auf Anfrage lieferbar:				Available on request:	
Rostfreier Stahl A2 oder A4				Stainless steel A2 or A4	
Anschlussgewinde Pg				Entry thread Pg	



1
2
3
4
5
6
7
8
9
10
11
12

Zubehör zu Kabelverschraubungen Messing und Kunststoff erhöhte Sicherheit Ex e II

Accessories for cable glands brass and synthetic for increased safety Ex e II

Zubehör | Accessoires

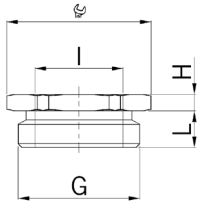

Reduktionen Messing erhöhte Sicherheit Ex e II

Material:	Messing vernickelt
O-Ring:	FPM
Einsatztemperatur:	-60°C / +100°C
Schutzart:	IP 66 / IP 68
Prüfnorm:	IEC EN 60079-0 / IEC EN 60079-7 / IEC EN 60079-31
Gas:	II 2G Ex eb IIC Gb
Staub:	II 2D Ex tb IIIC Db
Zone:	Gas 1 und 2 / Staub 21 und 22
Zertifikat:	SEV 15 ATEX 0151
IECEX Zertifikat:	IECEX SEV 15.0018

Reduction fittings nickel-plated brass increased safety Ex e II

Material:	Nickel-plated brass
O-ring:	FPM
Temperature range:	-60°C / +100°C
Protection class:	IP 66 / IP 68
Test standard:	IEC EN 60079-0 / IEC EN 60079-7 / IEC EN 60079-31
Gas:	II 2G Ex eb IIC Gb
Dust:	II 2D Ex tb IIIC Db
Zone:	Gas 1 and 2 / dust 21 and 22
Certificate:	SEV 15 ATEX 0151
IECEX Certificate:	IECEX SEV 15.0018



Reduktion MS EX



Aussengewinde metrisch
Innengewinde metrisch
mit O-Ring

Outer thread metric
Inner thread metric
with O-ring

G	I	i info	 mm	H mm	L mm	i info	Art.-Nr. Art. No.	
M10x1.5	M 8x1.25	1	13	8.0	5	2	EX3500.10.08	50
M12x1.5	M 8x1.25	1	15	3.0	5	2	EX3500.12.08	50
M12x1.5	M10x1.5	1	15	8.0	5	2	EX3500.12.10	50
M16x1.5	M10x1.5	1	18	3.0	5	-	EX3500.17.10	50
M16x1.5	M12x1.5	-	18	3.0	5	-	EX3500.17.12	50
M20x1.5	M12x1.5	-	24	3.0	6	-	EX3500.20.12	50
M20x1.5	M16x1.5	-	24	3.0	6	-	EX3500.20.17	50
M25x1.5	M16x1.5	-	30	3.5	7	-	EX3500.25.17	25
M25x1.5	M20x1.5	-	30	3.5	7	-	EX3500.25.20	25
M32x1.5	M20x1.5	-	36	4.0	8	-	EX3500.32.20	20
M32x1.5	M25x1.5	-	36	4.0	8	-	EX3500.32.25	20
M40x1.5	M25x1.5	-	46	4.5	8	-	EX3500.40.25	10
M40x1.5	M32x1.5	-	46	4.5	8	-	EX3500.40.32	10
M50x1.5	M32x1.5	-	55	5.0	9	-	EX3500.50.32	10
M50x1.5	M40x1.5	-	55	5.0	9	-	EX3500.50.40	10
M63x1.5	M40x1.5	-	70	5.5	10	-	EX3500.63.40	5
M63x1.5	M50x1.5	-	70	5.5	10	-	EX3500.63.50	5

1 = Metrisches Regelgewinde (mit VDE Testreport)

1 = Metric coarse-pitch thread (with VDE test report)

2 = Zertifikat SEV 15 ATEX 0152X / IECEx SEV 15.0019X

2 = Certificate SEV 15 ATEX 0152X / IECEx SEV 15.0019X

Das Ineinanderschrauben mehrerer Reduktionen/Erweiterungen ist nach Norm nicht zulässig!

The norm interdicts to screw several reduction/enlarging fittings into each other!

Zubehör zu Kabelverschraubungen Messing und Kunststoff erhöhte Sicherheit Ex e II

Accessories for cable glands brass and synthetic for increased safety Ex e II

Zubehör | Accessories

Reduktionen Messing erhöhte Sicherheit Ex e II

Material:	Messing vernickelt
O-Ring:	FPM
Einsatztemperatur:	-60°C / +100°C
Schutzart:	IP 66 / IP 68
Prüfnorm:	IEC EN 60079-0 / IEC EN 60079-7 / IEC EN 60079-31
Gas:	II 2G Ex eb IIC Gb
Staub:	II 2D Ex tb IIIC Db
Zone:	Gas 1 und 2 / Staub 21 und 22
Zertifikat:	SEV 15 ATEX 0151
IECEX Zertifikat:	IECEX SEV 15.0018

Reduction fittings nickel-plated brass increased safety Ex e II

Material:	Nickel-plated brass
O-ring:	FPM
Temperature range:	-60°C / +100°C
Protection class:	IP 66 / IP 68
Test standard:	IEC EN 60079-0 / IEC EN 60079-7 / IEC EN 60079-31
Gas:	II 2G Ex eb IIC Gb
Dust:	II 2D Ex tb IIIC Db
Zone:	Gas 1 and 2 / dust 21 and 22
Certificate:	SEV 15 ATEX 0151
IECEX Certificate:	IECEX SEV 15.0018

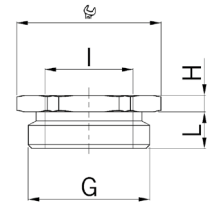

Reduktion MS EX



Aussengewinde Pg
Innengewinde metrisch
mit O-Ring

Outer thread Pg
Inner thread metric
with O-ring

G	I	i info	 mm	H mm	L mm	i info	Art.-Nr. Art. No.	
Pg 7	M 8x1.25	1	15	3.0	6	2	EX3500.07.08	50
Pg 7	M10x1.5	1	15	7.0	6	2	EX3500.07.10	50
Pg 9	M 8x1.25	1	18	3.0	6	-	EX3500.09.08	50
Pg 9	M10x1.5	1	18	3.0	6	-	EX3500.09.10	50
Pg 9	M12x1.5	-	18	8.0	6	-	EX3500.09.12	50
Pg 11	M 8x1.25	1	21	3.0	6	-	EX3500.11.08	50
Pg 11	M10x1.5	1	21	3.0	6	-	EX3500.11.10	50
Pg 11	M12x1.5	-	21	3.0	6	-	EX3500.11.12	50
Pg 11	M16x1.5	-	21	8.0	6	-	EX3500.11.17	50
Pg 13	M12x1.5	-	24	3.0	6	-	EX3500.13.12	50
Pg 13	M16x1.5	-	24	3.0	6	-	EX3500.13.17	50
Pg 16	M12x1.5	-	24	3.0	6	-	EX3500.16.12	25
Pg 16	M16x1.5	-	24	3.0	6	-	EX3500.16.17	25
Pg 16	M20x1.5	-	24	10.5	6	-	EX3500.16.20	25
Pg 21	M16x1.5	-	30	3.5	7.5	-	EX3500.21.17	25
Pg 21	M20x1.5	-	30	3.5	7.5	-	EX3500.21.20	25
Pg 21	M25x1.5	-	30	10.5	7.5	-	EX3500.21.25	25
Pg 29	M25x1.5	-	38	4.0	8	-	EX3500.29.25	20
Pg 29	M32x1.5	-	38	13.0	8	-	EX3500.29.32	20
Pg 36	M32x1.5	-	50	4.5	8	-	EX3500.36.32	10
Pg 36	M40x1.5	-	50	4.5	8	-	EX3500.36.40	10
Pg 42	M32x1.5	-	55	5.0	10	-	EX3500.42.32	10
Pg 42	M40x1.5	-	55	5.0	10	-	EX3500.42.40	10
Pg 42	M50x1.5	-	55	15.0	10	-	EX3500.42.50	10
Pg 48	M40x1.5	-	65	5.5	11	-	EX3500.48.40	5
Pg 48	M50x1.5	-	65	5.5	11	-	EX3500.48.50	5



1 = Metrisches Regelgewinde (mit VDE Testreport)

1 = Metric coarse-pitch thread (with VDE test report)

2 = Zertifikat SEV 15 ATEX 0152X / IECEx SEV 15.0019X

2 = Certificate SEV 15 ATEX 0152X / IECEx SEV 15.0019X

Das Ineinanderschrauben mehrerer Reduktionen/Erweiterungen ist nach Norm nicht zulässig!

The norm interdicts to screw several reduction/enlarging fittings into each other!

Zubehör zu Kabelverschraubungen Messing und Kunststoff erhöhte Sicherheit Ex e II

Accessories for cable glands brass and synthetic for increased safety Ex e II

Zubehör | Accessories

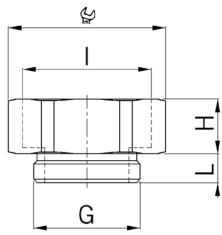

Erweiterungen Messing erhöhte Sicherheit Ex e II

Material:	Messing vernickelt
O-Ring:	FPM
Einsatztemperatur:	-60°C / +100°C
Schutzart:	IP 66 / IP 68
Prüfnorm:	IEC EN 60079-0 / IEC EN 60079-7 / IEC EN 60079-31
Gas:	II 2G Ex eb IIC Gb
Staub:	II 2D Ex tb IIIC Db
Zone:	Gas 1 und 2 / Staub 21 und 22
Zertifikat:	SEV 15 ATEX 0151
IECEX Zertifikat:	IECEX SEV 15.0018

Enlarging fittings nickel-plated brass increased safety Ex e II

Material:	Nickel-plated brass
O-ring:	FPM
Temperature range:	-60°C / +100°C
Protection class:	IP 66 / IP 68
Test standard:	IEC EN 60079-0 / IEC EN 60079-7 / IEC EN 60079-31
Gas:	II 2G Ex eb IIC Gb
Dust:	II 2D Ex tb IIIC Db
Zone:	Gas 1 and 2 / dust 21 and 22
Certificate:	SEV 15 ATEX 0151
IECEX Certificate:	IECEX SEV 15.0018



Erweiterung MS EX

Aussengewinde metrisch
Innengewinde metrisch
mit O-Ring

Outer thread metric
Inner thread metric
with O-ring



G	I	i info	 mm	H mm	L mm	i info	Art.-Nr. Art. No.	
M 8x1.25	M10x1.5	1	13	9	5	2	EX3600.08.10	50
M10x1.5	M12x1.5	1	15	9	5	2	EX3600.10.12	50
M12x1.5	M16x1.5	-	18	9	5	2	EX3600.12.17	50
M16x1.5	M20x1.5	-	24	10	5	-	EX3600.17.20	50
M20x1.5	M25x1.5	-	30	11.5	6	-	EX3600.20.25	25
M25x1.5	M32x1.5	-	36	14	7	-	EX3600.25.32	25
M32x1.5	M40x1.5	-	46	14	8	-	EX3600.32.40	25
M40x1.5	M50x1.5	-	55	16	8	-	EX3600.40.50	10
M50x1.5	M63x1.5	-	70	17	9	-	EX3600.50.63	10

1 = Metrisches Regelgewinde (mit VDE Testreport)

1 = Metric coarse-pitch thread (with VDE test report)

2 = Zertifikat SEV 15 ATEX 0152X / IECEx SEV 15.0019X

2 = Certificate SEV 15 ATEX 0152X / IECEx SEV 15.0019X

Das Ineinanderschrauben mehrerer Reduktionen/Erweiterungen ist nach Norm nicht zulässig!

The norm interdicts to screw several reduction/enlarging fittings into each other!

Zubehör zu Kabelverschraubungen Messing und Kunststoff erhöhte Sicherheit Ex e II

Accessories for cable glands brass and synthetic for increased safety Ex e II

Zubehör | Accessories

Erweiterungen Messing erhöhte Sicherheit Ex e II

Material:	Messing vernickelt
O-Ring:	FPM
Einsatztemperatur:	-60°C / +100°C
Schutzart:	IP 66 / IP 68
Prüfnorm:	IEC EN 60079-0 / IEC EN 60079-7 / IEC EN 60079-31
Gas:	II 2G Ex eb IIC Gb
Staub:	II 2D Ex tb IIIC Db
Zone:	Gas 1 und 2 / Staub 21 und 22
Zertifikat:	SEV 15 ATEX 0151
IECEX Zertifikat:	IECEX SEV 15.0018

Enlarging fittings nickel-plated brass increased safety Ex e II

Material:	Nickel-plated brass
O-ring:	FPM
Temperature range:	-60°C / +100°C
Protection class:	IP 66 / IP 68
Test standard:	IEC EN 60079-0 / IEC EN 60079-7 / IEC EN 60079-31
Gas:	II 2G Ex eb IIC Gb
Dust:	II 2D Ex tb IIIC Db
Zone:	Gas 1 and 2 / dust 21 and 22
Certificate:	SEV 15 ATEX 0151
IECEX Certificate:	IECEX SEV 15.0018

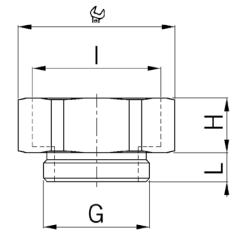



Erweiterung MS EX



Aussengewinde Pg
Innengewinde metrisch
mit O-Ring

Outer thread Pg
Inner thread metric
with O-ring

G	I	 mm	H mm	L mm	i info	Art.-Nr. Art. No.	
Pg 7	M12x1.5	15	9.0	6	2	EX3600.07.12	50
Pg 7	M16x1.5	18	9.0	6	2	EX3600.07.17	50
Pg 9	M16x1.5	18	9.5	6	-	EX3600.09.17	50
Pg 9	M20x1.5	24	10.5	6	-	EX3600.09.20	50
Pg 11	M20x1.5	24	10.5	6	-	EX3600.11.20	50
Pg 11	M25x1.5	30	11.5	6	-	EX3600.11.25	25
Pg 13	M20x1.5	24	10.5	6	-	EX3600.13.20	50
Pg 13	M25x1.5	30	11.5	6	-	EX3600.13.25	25
Pg 16	M25x1.5	30	11.5	6	-	EX3600.16.25	25
Pg 16	M32x1.5	36	13.5	6	-	EX3600.16.32	25
Pg 21	M32x1.5	36	14.0	7.5	-	EX3600.21.32	25
Pg 21	M40x1.5	46	14.0	7.5	-	EX3600.21.40	20
Pg 29	M40x1.5	46	14.0	8	-	EX3600.29.40	20
Pg 29	M50x1.5	55	16.0	8	-	EX3600.29.50	10
Pg 36	M50x1.5	55	16.0	8	-	EX3600.36.50	10
Pg 36	M63x1.5	70	17.0	8	-	EX3600.36.63	10
Pg 42	M63x1.5	70	17.0	10	-	EX3600.42.63	10
Pg 48	M63x1.5	70	17.0	11	-	EX3600.48.63	10



1 = Metrisches Regelgewinde (mit VDE Testreport)

1 = Metric coarse-pitch thread (with VDE test report)

2 = Zertifikat SEV 15 ATEX 0152X / IECEx SEV 15.0019X

2 = Certificate SEV 15 ATEX 0152X / IECEx SEV 15.0019X

Das Ineinanderschrauben mehrerer Reduktionen/Erweiterungen ist nach Norm nicht zulässig!

The norm interdicts to screw several reduction/enlarging fittings into each other!

Zubehör zu Kabelverschraubungen Messing und Kunststoff erhöhte Sicherheit Ex e II

Accessories for cable glands brass and synthetic for increased safety Ex e II

Kurzes Anschlussgewinde metrisch | Short entry thread metric

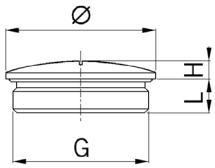

Verschlusschrauben Messing erhöhte Sicherheit Ex e II

Material:	Messing vernickelt
O-Ring:	FPM
Einsatztemperatur:	-60°C / +100°C
Schutzart:	IP 66 / IP 68
Prüfnorm:	IEC EN 60079-0 / IEC EN 60079-7 / IEC EN 60079-31
Gas:	II 2G Ex eb IIC Gb
Staub:	II 2D Ex tb IIIC Db
Zone:	Gas 1 und 2 / Staub 21 und 22
Zertifikat:	SEV 15 ATEX 0151
IECEx Zertifikat:	IECEx SEV 15.0018

Locking plugs nickel-plated brass increased safety Ex e II

Material:	Nickel-plated brass
O-ring:	FPM
Temperature range:	-60°C / +100°C
Protection class:	IP 66 / IP 68
Test standard:	IEC EN 60079-0 / IEC EN 60079-7 / IEC EN 60079-31
Gas:	II 2G Ex eb IIC Gb
Dust:	II 2D Ex tb IIIC Db
Zone:	Gas 1 and 2 / dust 21 and 22
Certificate:	SEV 15 ATEX 0151
IECEx Certificate:	IECEx SEV 15.0018



Verschlusszapfen MS EX



mit O-Ring					with O-ring	
G	Ø mm	H mm	L mm	i info	Art.-Nr. Art. No.	
M8x1.25	10	3	5	1	EX8708.08	50
M10x1.5	12	3	5	1	EX8710.08	50
M12x1.5	14	3	5	-	EX8712.08	50
M16x1.5	19	3	5	-	EX8717.08	50
M20x1.5	24	3	6	-	EX8720.08	25
M25x1.5	28	4	7	-	EX8725.08	25
M32x1.5	35	4	8	-	EX8732.08	10
M40x1.5	45	6	8	-	EX8740.08	10
M50x1.5	55	6	9	-	EX8750.08	10
M63x1.5	70	6	10	-	EX8763.08	10

1 = Metrisches Regelgewinde (mit VDE Testreport) 1 = Metric coarse-pitch thread (with VDE test report)

Auf Anfrage lieferbar: Available on request:

- Langes Anschlussgewinde - Long entry thread
- Verschlusschrauben aus rostfreiem Stahl A2 oder rostfreiem und säurebeständigem Stahl A4 mit kurzem oder langem Anschlussgewinde metrisch - Locking plugs in stainless steel A2 or acid-proof stainless steel A4 with short or long metric entry thread

Kurzes Anschlussgewinde Pg | Short entry thread Pg



Verschlusszapfen MS EX



mit O-Ring					with O-ring	
G	Ø mm	H mm	L mm		Art.-Nr. Art. No.	
Pg 7	14	3	5		EX8707.08	50
Pg 9	17	3	6		EX8709.08	50
Pg 11	20	3	6		EX8711.08	50
Pg 13	22	3	6.5		EX8713.08	50
Pg 16	24	3	6.5		EX8716.08	50
Pg 21	30	4	7		EX8721.08	10
Pg 29	39	4	8		EX8729.08	10
Pg 36	50	6	9		EX8736.08	10
Pg 48	65	6	10		EX8748.08	10

Auf Anfrage lieferbar: Available on request:

- Langes Anschlussgewinde - Long entry thread
- Verschlusschrauben aus rostfreiem Stahl A2 oder rostfreiem und säurebeständigem Stahl A4 mit kurzem oder langem Anschlussgewinde metrisch - Locking plugs in stainless steel A2 or acid-proof stainless steel A4 with short or long metric entry thread

Zubehör zu Kabelverschraubungen Messing und Kunststoff erhöhte Sicherheit Ex e II

Accessories for cable glands brass and synthetic for increased safety Ex e II

Anschlussgewinde metrisch | Entry thread metric

Verschlusschrauben Kunststoff erhöhte Sicherheit Ex e II

Material:	Polyamid
O-Ring:	NBR
Einsatztemperatur:	-20°C / +90°C
Schutzart:	IP 68
Prüfnorm:	IEC EN 60079-0 / IEC EN 60079-7 / IEC EN 60079-31
Gas:	II 2G Ex eb IIC Gb
Staub:	II 2D Ex tb IIIC Db
Zone:	Gas 1 und 2 / Staub 21 und 22
Zertifikat:	DMT 03 ATEX E 049
IECEx Zertifikat:	IECEx BVS 07.0021

Synthetic locking plugs for increased safety Ex e II

Material:	Polyamide
O-ring:	NBR
Temperature range:	-20°C / +90°C
Protection class:	IP 68
Test standard:	IEC EN 60079-0 / IEC EN 60079-7 / IEC EN 60079-31
Gas:	II 2G Ex eb IIC Gb
Dust:	II 2D Ex tb IIIC Db
Zone:	Gas 1 and 2 / dust 21 and 22
Certificate:	DMT 03 ATEX E 049
IECEx Certificate:	IECEx BVS 07.0021

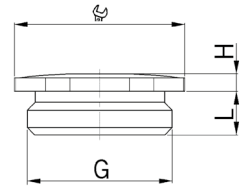

Schwarz RAL 9005 mit O-Ring					Black RAL 9005 with O-ring		
G			H	L	Art.-Nr. Art. No.		
	mm	mm	mm	mm			
M12x1.5	15	6	13.0	8.5	8841.12	100	
M16x1.5	19	8	13.0	8.5	8841.17	100	
M20x1.5	24	8	14.5	9.0	8841.20	100	
M25x1.5	28	8	16.0	10.5	8841.25	100	
M32x1.5	36	8	17.5	11.5	8841.32	100	
M40x1.5	46	8	18.0	11.5	8841.40	50	
M50x1.5	55	8	20.0	13.5	8841.50	25	
M63x1.5	70	8	21.0	14.5	8841.63	10	



Anschlussgewinde Pg | Entry thread Pg



Schwarz RAL 9005 mit O-Ring					Black RAL 9005 with O-ring		
G			H	L	Art.-Nr. Art. No.		
	mm	mm	mm	mm			
Pg 7	15	6	13.0	8.5	8841.07	100	
Pg 9	19	8	13.0	8.5	8841.09	100	
Pg 11	24	8	14.5	9.0	8841.11	100	
Pg 13	24	8	14.5	9.0	8841.13	100	
Pg 16	28	8	16.0	10.5	8841.16	100	
Pg 21	36	8	17.5	11.5	8841.21	100	
Pg 29	46	8	18.0	11.5	8841.29	50	
Pg 36	55	8	20.0	13.5	8841.36	25	
Pg 42	60	8	20.0	13.5	8841.42	10	
Pg 48	70	8	21.0	14.5	8841.48	10	



AGRO Kombi-Schlauchverschraubung aus Messing

AGRO Combination conduit glands nickel-plated brass

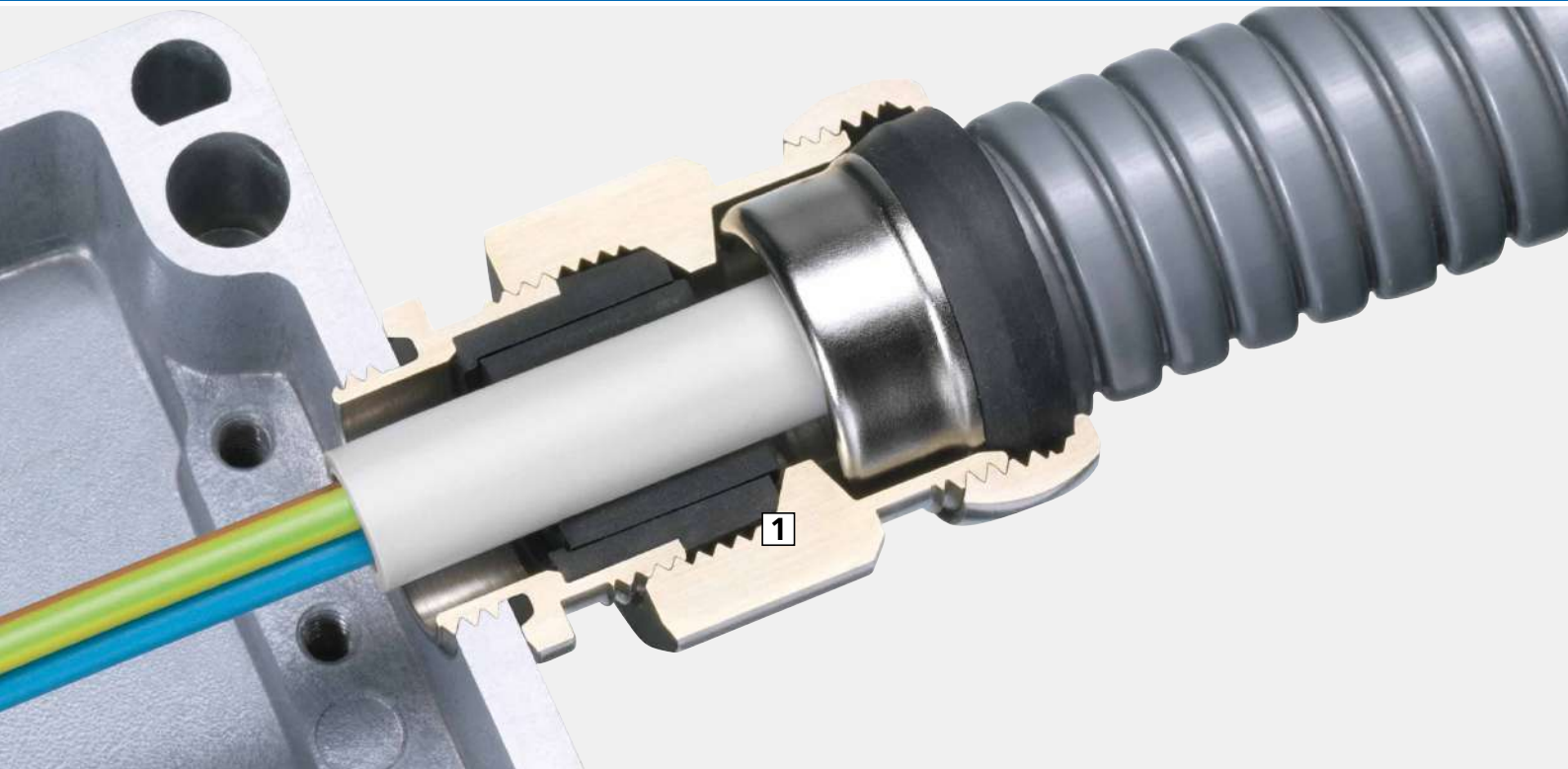

AGRO Kombi-Schlauchverschraubungen sind eine optimale Lösung, wenn Sie Kabel in einem Schutzschlauch in ein Gehäuse einführen wollen und gleichzeitig eine sichere Abdichtung und Zugentlastung des Kabels möchten.

1 Dichtheit

Mit der integrierten Kabelverschraubung erzielen Sie eine hervorragende Dichtheit (IP 68) im Innenbereich des Schutzschlauchs. So verhindern Sie das Eindringen von Flüssigkeiten und Kondenswasser.

Integrierte EMV Kabelverschraubung

Die Kombi-Schlauchverschraubung gibt es auch als kombinierte Variante für geschirmte Kabel.

Kommen Kombi-Schlauchverschraubungen in **Bahnapplikationen** zum Einsatz – etwa weil Kabel in Schutzschläuchen geführt werden, um sie vor Schlägen oder Manipulation zu schützen – so gelten für sie die selben Anforderungen wie für Kabelverschraubungen: sie müssen mit einem Dichteinsatz aus Spezial-TPE gemäss **EN 45545** bestückt werden.

AGRO Combination conduit glands are an optimal solution if you want to introduce cables inside a conduit into an enclosure and at the same time want a secure seal and strain relief for the cables.

1 Sealing capability





The integrated cable gland achieves excellent sealing (IP 68) inside the conduit. In this way, you make certain that water and condensate cannot make its way inside.

Integrated EMC cable gland

The combination conduit gland is also available in a special version for shielded cables.

In cases where combination conduit glands are used for **railway applications** – for instance when cables are laid in conduits in order to protect them from impacts or manipulation – the same requirements apply as for cable glands: the combination conduit glands must be equipped with a sealing insert made of special TPE according to the requirements of **EN 45545**.

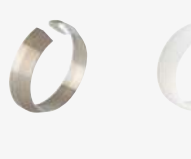

<p>AGRO Kombi-Schlauchverschraubung Progress® Messing mit integrierter Kabelverschraubung AGRO Combination conduit glands Progress® nickel-plated brass with integrated cable gland</p>	 <p>160 - 162</p>	<p>1</p>
<p>AGRO Adapter Progress® Messing mit integrierter Kabelverschraubung AGRO Adapter Progress® nickel-plated brass with integrated cable gland</p>	 <p>163 - 164</p>	<p>2</p>
<p>AGRO Kombi-Schlauchverschraubung Progress® EMV Messing mit integrierter Kabelverschraubung AGRO Combination conduit glands Progress® EMC nickel-plated brass with integrated cable gland</p>	 <p>165 - 167</p>	<p>3</p>
<p>AGRO Adapter Progress® Messing mit integrierter EMV-Kabelverschraubung AGRO Adapters Progress® nickel-plated brass with integrated EMC cable gland</p>	 <p>168 - 169</p>	<p>4</p>
<p>AGRO Kombi-EMV-Schlauchverschraubung für Kupfer-Hohlgeflechte AGRO Combination EMC conduit gland for copper braidings</p>	 <p>170</p>	<p>5</p>
<p>Zubehör zu Schlauchverschraubungen Conduit glands accessories</p>	 <p>171</p>	<p>6</p>

AGRO Kombi-Schlauchverschraubung Progress® Messing mit integrierter Kabelverschraubung

AGRO combination conduit glands Progress® nickel-plated brass with integrated cable gland

Kurzes Anschlussgewinde metrisch | Filet de raccordement métrique court

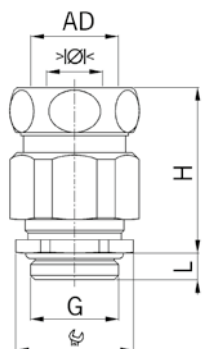

Material: Messing vernickelt
 Dichtung: TPE
 O-Ring: NBR
 Zugentlastung: Ausführung A nach EN 62444
 Schutzart: Kabelverschraubung IP 68
 Einsatztemperatur: -40°C / +100°C
 Hinweis: Der max. Klemmbereich ist abhängig vom Schlauch-Innendurchmesser

Material: Nickel-plated brass
 Seal: TPE
 O-ring: NBR
 Strain relief: Version A acc. to EN 62444
 Protection class: Cable gland IP 68
 Temperature range: -40°C / +100°C
 Note: The max. clamping range depends on the conduit inner diameter



Progress MS Kombi



Für Schlauchanschluss AD mm
 Zweiteiliger Dichteinsatz
 nicht durchgehend isolierend

Connector for tubing with AD mm
 Two-piece sealing insert
 not overall length insulated

G	AD mm	>Ø< min mm	>Ø< max mm	>Ø< min mm	>Ø< max mm	Ø mm	H mm	L mm	Art.-Nr. Art. No.	Icon
M12x1.5	10	-	-	5.0	6.5	15/17	33	5	1700.12.10	50
M16x1.5	14	6.0	8.0	8.0	10.5	18/21	38	5	1700.17.14	50
M20x1.5	17	8.0	11.0	11.0	15.0	24/25	38	6	1700.20.17	25
M20x1.5	19	8.0	11.0	11.0	15.0	24/27	39	6	1700.20.19	25
M20x1.5	21	8.0	11.0	11.0	15.0	24/29	39	6	1700.20.21	25
M25x1.5	21	12.5	16.0	16.0	20.5	30/29	43	7	1700.25.21	25
M25x1.5	27	12.5	16.0	16.0	20.5	30/36	50	7	1700.25.27	25
M32x1.5	27	17.0	21.0	21.0	25.5	36/36	52	8	1700.32.27	25
M40x1.5	36	24.0	28.5	28.5	33.0	46/45	56	8	1700.40.36	10
M50x1.5	45	33.0	37.0	37.0	42.0	55/54	60	9	1700.50.45	10
M63x1.5	56	40.0	46.0	46.0	52.0	70/66	67	10	1700.63.56	5

Je nach Schlauchtyp muss die passende Stabilisierungshülse separat bestellt werden.

Depending on the type of conduit, the stabilising bush must be ordered separately.

Erhältlich mit Dichteinsatz gemäss EN 45545. Bei Anfragen oder Bestellung bitte ein F vor die Artikelnummer setzen.

Available with sealing inserts conformity with EN 45545. When placing an inquiry, prefix the article number by the capital F.



Progress MS Kombi



Für Schlauchanschluss AD Zoll
 Zweiteiliger Dichteinsatz
 nicht durchgehend isolierend

Connector for tubing with AD in inches
 Two-piece sealing insert
 not overall length insulated

G	AD mm	>Ø< min mm	>Ø< max mm	>Ø< min mm	>Ø< max mm	Ø mm	H mm	L mm	Art.-Nr. Art. No.	Icon
M12x1.5	1/4"	-	-	5.0	6.5	15/19	35	5	1700.12.1/4	50
M20x1.5	3/8"	8.0	11.0	11.0	15.0	24/27	42	6	1700.20.3/8	25
M20x1.5	1/2"	8.0	11.0	11.0	15.0	24/29	38	6	1700.20.1/2	25
M25x1.5	3/4"	12.5	16.0	16.0	20.5	30/36	52	7	1700.25.3/4	25
M32x1.5	1"	17.0	21.0	21.0	25.5	36/45	55	8	1700.32.1	25
M40x1.5	1 1/4"	24.0	28.5	28.5	33.0	46/54	62	8	1700.40.11/4	10
M63x1.5	2"	40.0	46.0	46.0	52.0	70/70	74	10	1700.63.2	5

Je nach Schlauchtyp muss die passende Stabilisierungshülse separat bestellt werden.

Depending on the type of conduit, the stabilising bush must be ordered separately.

Erhältlich mit Dichteinsatz gemäss EN 45545. Bei Anfragen oder Bestellung bitte ein F vor die Artikelnummer setzen.

Available with sealing inserts conformity with EN 45545. When placing an inquiry, prefix the article number by the capital F.

AGRO Kombi-Schlauchverschraubung Progress® Messing mit integrierter Kabelverschraubung

AGRO combination conduit glands Progress® nickel-plated brass with integrated cable gland

Langes Anschlussgewinde metrisch | Long entry thread metric

Material: Messing vernickelt
 Dichtung: TPE
 O-Ring: NBR
 Zugentlastung: Ausführung A nach EN 62444
 Schutzart: Kabelverschraubung IP 68
 Einsatztemperatur: -40°C / +100°C
 Hinweis: Der max. Klemmbereich ist abhängig vom Schlauch-Innendurchmesser

Material: Nickel-plated brass
 Seal: TPE
 O-ring: NBR
 Strain relief: Version A acc. to EN 62444
 Protection class: Cable gland IP 68
 Temperature range: -40°C / +100°C
 Note: The max. clamping range depends on the conduit inner diameter

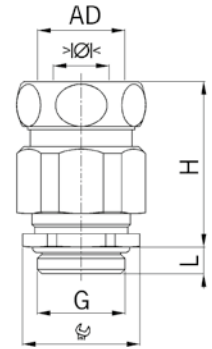

Progress MS Kombi

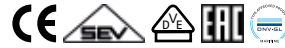

Für Schlauchanschluss AD mm
 Zweiteiliger Dichteinsatz durchgehend isolierend

Connector for tubing with AD mm
 Two-piece sealing insert overall length insulated

G	AD mm	> Ø < min mm	> Ø < max mm	> Ø < min mm	> Ø < max mm	Ø mm	H mm	L mm	Art.-Nr. Art. No.	
M12x1.5	10	-	-	5.0	6.5	15/17	33	10	1710.60.12.10	50
M16x1.5	14	6.0	8.0	8.0	10.5	18/21	38	10	1710.60.17.14	50
M20x1.5	17	8.0	11.0	11.0	14.5	24/25	38	10	1710.60.20.17	25
M20x1.5	19	8.0	11.0	11.0	14.5	24/27	39	10	1710.60.20.19	25
M20x1.5	21	8.0	11.0	11.0	14.5	24/29	39	10	1710.60.20.21	25
M25x1.5	21	12.5	16.0	16.0	19.0	30/29	43	11	1710.60.25.21	25
M25x1.5	27	12.5	16.0	16.0	19.0	30/36	50	11	1710.60.25.27	25
M32x1.5	27	17.0	21.0	21.0	25.5	36/36	52	13	1710.60.32.27	25
M40x1.5	36	24.0	28.5	28.5	33.0	46/45	56	13	1710.60.40.36	10
M50x1.5	45	33.0	37.0	37.0	42.0	55/54	60	14	1710.60.50.45	10
M63x1.5	56	40.0	46.0	46.0	52.0	70/66	67	14	1710.60.63.56	5



Je nach Schlauchtyp muss die passende Stabilisierungshülse separat bestellt werden.

Depending on the type of conduit, the stabilising bush must be ordered separately.

Erhältlich mit Dichteinsatz gemäss EN 45545. Bei Anfragen oder Bestellung bitte ein F vor die Artikelnummer setzen.

Available with sealing inserts conformity with EN 45545. When placing an inquiry, prefix the article number by the capital F.

Progress MS Kombi



Für Schlauchanschluss AD Zoll
 Zweiteiliger Dichteinsatz durchgehend isolierend

Connector for tubing with AD in inches
 Two-piece sealing insert overall length insulated

G	AD mm	> Ø < min mm	> Ø < max mm	> Ø < min mm	> Ø < max mm	Ø mm	H mm	L mm	Art.-Nr. Art. No.	
M12x1.5	1/4"	-	-	5.0	6.5	15/19	35	10	1710.60.12.1/4	50
M20x1.5	3/8"	8.0	11.0	11.0	14.5	24/27	42	10	1710.60.20.3/8	25
M20x1.5	1/2"	8.0	11.0	11.0	14.5	24/29	38	10	1710.60.20.1/2	25
M25x1.5	3/4"	12.5	16.0	16.0	19.0	30/36	52	11	1710.60.25.3/4	25
M32x1.5	1"	12.5	16.0	16.0	19.0	36/45	55	13	1710.60.32.1	25
M40x1.5	1 1/4"	24.0	28.5	28.5	33.0	46/54	62	13	1710.60.40.11/4	10
M63x1.5	2"	40.0	46.0	46.0	52.0	70/70	74	14	1710.60.63.2	5



Je nach Schlauchtyp muss die passende Stabilisierungshülse separat bestellt werden.

Depending on the type of conduit, the stabilising bush must be ordered separately.

Erhältlich mit Dichteinsatz gemäss EN 45545. Bei Anfragen oder Bestellung bitte ein F vor die Artikelnummer setzen.

Available with sealing inserts conformity with EN 45545. When placing an inquiry, prefix the article number by the capital F.

AGRO Kombi-Schlauchverschraubung Progress® Messing mit integrierter Kabelverschraubung

AGRO combination conduit glands Progress® nickel-plated brass with integrated cable gland

Kurzes Anschlussgewinde Pg | Short entry thread Pg

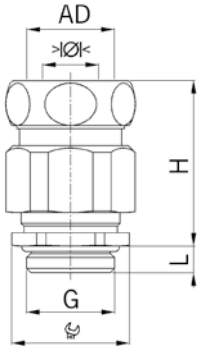

Material: Messing vernickelt
 Dichtung: TPE
 O-Ring: NBR
 Schutzart: Kabelverschraubung IP 68
 Einsatztemperatur: -40°C / +100°C
 Hinweis: Der max. Klemmbereich ist abhängig vom Schlauch-Innendurchmesser

Material: Nickel-plated brass
 Seal: TPE
 O-ring: NBR
 Protection class: Cable gland IP 68
 Temperature range: -40°C / +100°C
 Note: The max. clamping range depends on the conduit inner diameter



Progress MS Kombi

Für Schlauchanschluss AD mm
 Zweiteiliger Dichteinsatz
 nicht durchgehend isolierend

Connector for tubing with AD mm
 Two-piece sealing insert
 not overall length insulated

G	AD mm	> Ø < min mm	> Ø < max mm	> Ø < min mm	> Ø < max mm	⌀ mm	H mm	L mm	Art.-Nr. Art. No.	
Pg 7	10	-	-	5.0	6.5	15/17	33	6	1700.07.10	50
Pg 9	14	6.0	8.0	8.0	10.5	18/21	38	6	1700.09.14	50
Pg 11	14	5.5	8.5	8.5	12.0	21/21	39	6	1700.11.14	50
Pg 11	17	5.5	8.5	8.5	12.0	21/25	39	6	1700.11.17	50
Pg 13	19	8.0	11.0	11.0	15.0	24/27	39	6	1700.13.19	25
Pg 16	17	8.0	11.0	11.0	15.0	24/25	38	6	1700.16.17	25
Pg 16	21	8.0	11.0	11.0	15.0	24/29	39	6	1700.16.21	25
Pg 21	27	12.5	16.0	16.0	20.5	30/36	50	7.5	1700.21.27	25
Pg 29	36	19.0	23.0	23.0	27.5	38/45	55	8	1700.29.36	25
Pg 36	45	26.0	30.5	30.5	35.0	50/54	60	8	1700.36.45	10
Pg 42	45	33.0	37.0	37.0	42.0	55/54	60	10	1700.42.45	10
Pg 48	56	37.0	43.0	43.0	49.0	65/66	67	11	1700.48.56	10

Je nach Schlauchtyp muss die passende Stabilisierungshülse separat bestellt werden.

Depending on the type of conduit, the stabilising bush must be ordered separately.

Erhältlich mit Dichteinsatz gemäss EN 45545. Bei Anfragen oder Bestellung bitte ein F vor die Artikelnummer setzen.

Available with sealing inserts conformity with EN 45545. When placing an inquiry, prefix the article number by the capital F.

Langes Anschlussgewinde Pg | Long entry thread Pg



Progress MS Kombi

Für Schlauchanschluss AD mm
 Zweiteiliger Dichteinsatz
 durchgehend isolierend

Connector for tubing with AD mm
 Two-piece sealing insert
 overall length insulated

G	AD mm	> Ø < min mm	> Ø < max mm	> Ø < min mm	> Ø < max mm	⌀ mm	H mm	L mm	Art.-Nr. Art. No.	
Pg 7	10	-	-	5.0	6.5	15/17	33	10	1710.60.07.10	50
Pg 9	14	6.0	8.0	8.0	10.5	18/21	38	10	1710.60.09.14	50
Pg 11	14	5.5	8.5	8.5	12.0	21/21	39	10	1710.60.11.14	50
Pg 11	17	5.5	8.5	8.5	12.0	21/25	39	10	1710.60.11.17	50
Pg 13	19	8.0	11.0	11.0	14.5	24/27	39	10	1710.60.13.19	25
Pg 16	17	8.0	11.0	11.0	14.5	24/25	38	10	1710.60.16.17	25
Pg 16	21	8.0	11.0	11.0	14.5	24/29	39	10	1710.60.16.21	25
Pg 21	27	12.5	16.0	16.0	19.0	30/36	50	12	1710.60.21.27	25
Pg 29	36	19.0	23.0	23.0	27.5	38/45	55	12	1710.60.29.36	25
Pg 36	45	26.0	30.5	30.5	35.0	50/54	60	15	1710.60.36.45	10
Pg 42	45	33.0	37.0	37.0	42.0	55/54	60	15	1710.60.42.45	10
Pg 48	56	37.0	43.0	43.0	49.0	65/66	67	15	1710.60.48.56	10

Je nach Schlauchtyp muss die passende Stabilisierungshülse separat bestellt werden.

Depending on the type of conduit, the stabilising bush must be ordered separately.

Erhältlich mit Dichteinsatz gemäss EN 45545. Bei Anfragen oder Bestellung bitte ein F vor die Artikelnummer setzen.

Available with sealing inserts conformity with EN 45545. When placing an inquiry, prefix the article number by the capital F.

AGRO Adapter Progress® Messing mit integrierter Kabelverschraubung

AGRO Adapter Progress® nickel-plated brass with integrated cable gland

Langes Anschlussgewinde metrisch | Long entry thread metric

Material: Messing vernickelt
 Dichtung: TPE
 O-Ring: NBR
 Zugentlastung: Ausführung A nach EN 62444
 Schutzart: Kabelverschraubung IP 68
 Einsatztemperatur: -40°C / +100°C
 Hinweis: Der max. Klemmbereich ist abhängig vom Schlauch-Innendurchmesser

Material: Nickel-plated brass
 Seal: TPE
 O-ring: NBR
 Strain relief: Version A acc. to EN 62444
 Protection class: Cable gland IP 68
 Temperature range: -40°C / +100°C
 Note: The max. clamping range depends on the conduit inner diameter

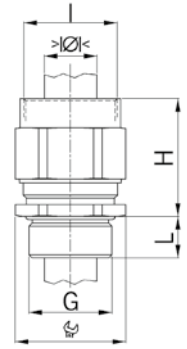

Progress MS Adapter

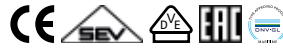

Einteiliger Dichteinsatz durchgehend isolierend

One-piece sealing insert overall length insulated

G	I	>Ø< min mm	>Ø< max mm	Ø mm	H mm	L mm	i info	Art.-Nr. Art. No.	
M10x1.5	M10x1.5	4.0	6.0	13	30	10	1	1165.10	50
M12x1.5	M12x1.5	5.0	6.5	15	32	10	-	1165.12	50

1 = Metrisches Regelgewinde (mit VDE Testreport)

1 = Metric coarse-pitch thread (with VDE test report)

Erhältlich mit Dichteinsatz gemäss EN 45545. Bei Anfragen oder Bestellung bitte ein F vor die Artikelnummer setzen.

Available with sealing inserts conformity with EN 45545. When placing an inquiry, prefix the article number by the capital F.



Progress MS Adapter



Zweiteiliger Dichteinsatz durchgehend isolierend

Two-piece sealing insert overall length insulated

G	I	>Ø< min mm	>Ø< max mm	>Ø< min mm	>Ø< max mm	Ø mm	H mm	L mm	Art.-Nr. Art. No.	
M16x1.5	M16x1.5	6.0	8.0	8.0	10.5	18	35	10	1165.17	50
M20x1.5	M20x1.5	8.0	11.0	11.0	14.5	24	36	10	1165.20	25
M25x1.5	M25x1.5	12.5	16.0	16.0	19.0	30	41	11	1165.25	25
M32x1.5	M32x1.5	17.0	21.0	21.0	25.5	36	46	13	1165.32	25
M40x1.5	M40x1.5	24.0	28.5	28.5	33.0	46	48	13	1165.40	10
M50x1.5	M50x1.5	33.0	37.0	37.0	42.0	55	53	14	1165.50	5
M63x1.5	M63x1.5	40.0	46.0	46.0	52.0	70	56	14	1165.63	5

Erhältlich mit Dichteinsatz gemäss EN 45545. Bei Anfragen oder Bestellung bitte ein F vor die Artikelnummer setzen.

Available with sealing inserts conformity with EN 45545. When placing an inquiry, prefix the article number by the capital F.



AGRO Adapter Progress® Messing mit integrierter Kabelverschraubung

AGRO Adapter Progress® nickel-plated brass with integrated cable gland

Langes Anschlussgewinde Pg | Long entry thread Pg

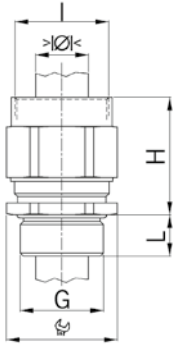

Material: Messing vernickelt
 Dichtung: TPE
 O-Ring: NBR
 Schutzart: Kabelverschraubung IP 68
 Einsatztemperatur: -40°C / +100°C
 Hinweis: Der max. Klemmbereich ist abhängig vom Schlauch-Innendurchmesser

Material: Nickel-plated brass
 Seal: TPE
 O-ring: NBR
 Protection class: Cable gland IP 68
 Temperature range: -40°C / +100°C
 Note: The max. clamping range depends on the conduit inner diameter

Progress MS Adapter



Einteiliger Dichteinsatz durchgehend isolierend

One-piece sealing insert overall length insulated

G	I	>Ø< min mm	>Ø< max mm	Ø mm	H mm	L mm	Art.-Nr. Art. No.	
Pg 7	Pg 7	5.0	6.5	15	30	10	1165.07	50

Erhältlich mit Dichteinsatz gemäss EN 45545. Bei Anfragen oder Bestellung bitte ein F vor die Artikelnummer setzen.

Available with sealing inserts conformity with EN 45545. When placing an inquiry, prefix the article number by the capital F.

Progress MS Adapter



Zweiteiliger Dichteinsatz durchgehend isolierend

Two-piece sealing insert overall length insulated

G	I	>Ø< min mm	>Ø< max mm	>Ø< min mm	>Ø< max mm	Ø mm	H mm	L mm	Art.-Nr. Art. No.	
Pg 9	Pg 9	6.0	8.0	8.0	10.5	18	35	10	1165.09	50
Pg 11	Pg 11	5.5	8.5	8.5	12.0	21	36	10	1165.11	50
Pg 13	Pg 13	8.0	11.0	11.0	14.5	24	36	10	1165.13	25
Pg 16	Pg 16	8.0	11.0	11.0	14.5	24	37	10	1165.16	25
Pg 21	Pg 21	12.5	16.0	16.0	19.0	30	42	12	1165.21	25
Pg 29	Pg 29	19.0	23.0	23.0	27.5	38/40	45	12	1165.29	25
Pg 36	Pg 36	26.0	30.5	30.5	35.0	50	52	15	1165.36	10
Pg 48	Pg 48	37.0	43.0	43.0	49.0	65	56	15	1165.48	5

Erhältlich mit Dichteinsatz gemäss EN 45545. Bei Anfragen oder Bestellung bitte ein F vor die Artikelnummer setzen.

Available with sealing inserts conformity with EN 45545. When placing an inquiry, prefix the article number by the capital F.

AGRO Kombi-Schlauchverschraubung Progress® EMV Messing mit integrierter Kabelverschraubung

AGRO combination conduit glands Progress® EMC nickel-plated brass with integrated cable gland

Langes Anschlussgewinde metrisch | Long entry thread metric

Material:	Messing vernickelt	Material:	Nickel-plated brass
Dichtung:	TPE	Seal:	TPE
O-Ring:	NBR	O-ring:	NBR
Zugentlastung:	Ausführung A nach EN 62444	Strain relief:	Version A acc. to EN 62444
Schutzart:	Kabelverschraubung IP 68	Protection class:	Cable gland IP 68
Einsatztemperatur:	-40°C / +100°C	Temperature range:	-40°C / +100°C
Hinweis:	Der max. Klemmbe- reich ist abhängig vom Schlauch-Innendurch- messer	Note:	The max. clamping range depends on the conduit inner diameter
Eigenschaften:	Sehr guter Schirmkontakt über die Kontakthülse bei in der Kabelver- schraubung endendem Schirmgeflecht	Properties:	Excellent shield contact through the contact sleeve with the braided shield terminating in the screwed cable gland

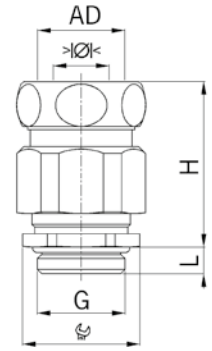

Progress MS Kombi EMC



Einteiliger Dichteinsatz
nicht durchgehend isolierend

One-piece sealing insert
not overall length insulated

G	AD mm	>Ø< min mm	>Ø< max mm	Ø mm	H mm	L mm	Art.-Nr. Art. No.	
M12x1.5	10	4.5	6.0	15-17	35	10	1710.80.12.060.1	25
M16x1.5	14	6.0	8.0	18/21	40	10	1710.80.17.080.1	25
M16x1.5	14	8.0	10.0	18/21	40	10	1710.80.17.100.1	25
M20x1.5	17	8.0	11.0	24/25	42	10	1710.80.20.110.1	25
M20x1.5	17	11.0	14.0	24/25	42	10	1710.80.20.140.1	25
M20x1.5	19	8.0	11.0	24/27	43	10	1710.80.20.110.2	25
M20x1.5	19	11.0	14.0	24/27	43	10	1710.80.20.140.2	25
M25x1.5	21	13.0	16.0	30/29	48	11	1710.80.25.160.1	25
M25x1.5	27	16.0	19.0	30/36	52	11	1710.80.25.190.1	25
M32x1.5	27	18.0	21.0	36/36	55	13	1710.80.32.210.1	10
M32x1.5	27	21.0	25.0	36/36	55	13	1710.80.32.250.1	10
M40x1.5	36	24.0	28.5	46/45	60	13	1710.80.40.285.1	10
M40x1.5	36	28.5	32.0	46/45	60	13	1710.80.40.320.1	10
M50x1.5	45	33.0	37.0	55/54	62	14	1710.80.50.370.1	5
M50x1.5	45	37.0	41.0	55/54	62	14	1710.80.50.410.1	5
M63x1.5	56	40.0	46.0	70/66	69	14	1710.80.63.460.1	5
M63x1.5	56	46.0	50.0	70/66	69	14	1710.80.63.500.1	5



Je nach Schlauchtyp muss die passende Stabilisierungshülse separat bestellt werden.

Depending on the type of conduit, the stabilising bush must be ordered separately.

Erhältlich mit Dichteinsatz gemäss EN 45545. Bei Anfragen oder Bestellung bitte ein F vor die Artikelnummer setzen.

Available with sealing inserts conformity with EN 45545. When placing an inquiry, prefix the article number by the capital F.

AGRO Kombi-Schlauchverschraubung Progress® EMV Messing mit integrierter Kabelverschraubung

AGRO combination conduit glands Progress® EMC nickel-plated brass with integrated cable gland

Langes Anschlussgewinde metrisch | Long entry thread metric

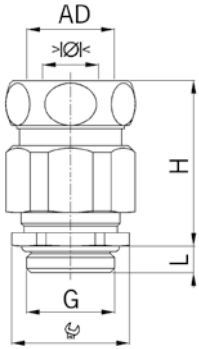

Material: Messing vernickelt
 Dichtung: TPE
 O-Ring: NBR
 Zugentlastung: Ausführung A nach EN 62444
 Schutzart: Kabelverschraubung IP 68
 Einsatztemperatur: -40°C / +100°C
 Hinweis: Der max. Klemmbereich ist abhängig vom Schlauch-Innendurchmesser
 Eigenschaften: Sehr guter Schirmkontakt über die Kontakthülse bei in der Kabelverschraubung endendem Schirmgeflecht

Material: Nickel-plated brass
 Seal: TPE
 O-ring: NBR
 Strain relief: Version A acc. to EN 62444
 Protection class: Cable gland IP 68
 Temperature range: -40°C / +100°C
 Note: The max. clamping range depends on the conduit inner diameter
 Properties: Excellent shield contact through the contact sleeve with the braided shield terminating in the screwed cable gland



Progress MS Kombi EMC



Einteiliger Dichteinsatz
 nicht durchgehend isolierend

One-piece sealing insert
 not overall length insulated

G	AD mm	> Ø < min mm	> Ø < max mm	⌀ mm	H mm	L mm	Art.-Nr. Art. No.	⊠
M12x1.5	1/4"	4.5	6.0	15/19	35	10	1710.80.12.060.2	25
M16x1.5	5/16"	6.0	8.0	18/21	38	10	1710.80.17.080.2	25
M16x1.5	5/16"	8.0	10.0	18/21	38	10	1710.80.17.100.2	25
M20x1.5	3/8"	8.0	11.0	24/27	42	10	1710.80.20.110.3	25
M20x1.5	1/2"	8.0	11.0	24/29	38	10	1710.80.20.110.4	25
M20x1.5	1/2"	11.0	14.0	24/29	38	10	1710.80.20.140.4	25
M25x1.5	3/4"	13.0	16.0	30/36	52	11	1710.80.25.160.2	25
M25x1.5	3/4"	16.0	19.0	30/36	52	11	1710.80.25.190.2	25
M32x1.5	1"	18.0	21.0	36/45	55	13	1710.80.32.210.2	10
M32x1.5	1"	21.0	25.0	36/45	55	13	1710.80.32.250.2	10
M40x1.5	1 1/4"	24.0	28.5	46/54	62	13	1710.80.40.285.2	10
M40x1.5	1 1/4"	28.5	32.0	46/54	62	13	1710.80.40.320.2	10
M63x1.5	2"	40.0	46.0	70/70	74	14	1710.80.63.460.2	5
M63x1.5	2"	46.0	50.0	70/70	74	14	1710.80.63.500.2	5

Je nach Schlauchtyp muss die passende Stabilisierungshülse separat bestellt werden.

Depending on the type of conduit, the stabilising bush must be ordered separately.

Erhältlich mit Dichteinsatz gemäss EN 45545. Bei Anfragen oder Bestellung bitte ein F vor die Artikelnummer setzen.

Available with sealing inserts conformity with EN 45545. When placing an inquiry, prefix the article number by the capital F.

AGRO Kombi-Schlauchverschraubung Progress® EMV Messing mit integrierter Kabelverschraubung

AGRO combination conduit glands Progress® EMC nickel-plated brass with integrated cable gland

Langes Anschlussgewinde Pg | Long entry thread Pg

Material:	Messing vernickelt	Material:	Nickel-plated brass
Dichtung:	TPE	Seal:	TPE
O-Ring:	NBR	O-ring:	NBR
Schutzart:	Kabelverschraubung IP 68	Protection class:	Cable gland IP 68
Einsatztemperatur:	-40°C / +100°C	Temperature range:	-40°C / +100°C
Hinweis:	Der max. Klemmbereich ist abhängig vom Schlauch-Innendurchmesser	Note:	The max. clamping range depends on the conduit inner diameter
Eigenschaften:	Sehr guter Schirmkontakt über die Kontakthülse bei in der Kabelverschraubung endendem Schirmgeflecht	Properties:	Excellent shield contact through the contact sleeve with the braided shield terminating in the screwed cable gland

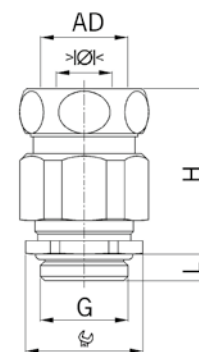

Progress MS Kombi EMC



Einteiliger Dichteinsatz
nicht durchgehend isolierend

One-piece sealing insert
not overall length insulated

G	AD mm	> Ø < min mm	> Ø < max mm	⌀ mm	H mm	L mm	Art.-Nr. Art. No.	
Pg 7	10	4.5	6.0	15/17	35	10	1710.80.07.060.1	25
Pg 9	14	6.0	8.0	18/21	40	10	1710.80.09.080.1	25
Pg 9	14	8.0	10.0	18/21	40	10	1710.80.09.100.1	25
Pg 11	17	8.5	12.0	21/25	41	10	1710.80.11.120.1	25
Pg 11	17	5.5	8.5	21/25	41	10	1710.80.11.085.1	25
Pg 13	19	8.0	11.0	24/27	42	10	1710.80.13.110.1	25
Pg 13	19	11.0	14.0	24/27	42	10	1710.80.13.140.1	25
Pg 16	21	8.0	11.0	24/29	43	10	1710.80.16.110.1	25
Pg 16	21	11.0	14.0	24/29	43	10	1710.80.16.140.1	25
Pg 21	27	13.0	16.0	30/36	55	12	1710.80.21.160.1	10
Pg 21	27	16.0	19.0	30/36	55	12	1710.80.21.190.1	10
Pg 29	36	19.0	23.0	38/45	57	12	1710.80.29.230.1	10
Pg 29	36	23.0	25.5	38/45	57	12	1710.80.29.255.1	10
Pg 36	45	25.0	30.5	50/54	62	15	1710.80.36.305.1	5
Pg 36	45	30.5	35.0	50/54	62	15	1710.80.36.350.1	5
Pg 42	45	33.0	37.0	55/54	62	15	1710.80.42.370.1	5
Pg 42	45	37.0	41.0	55/54	62	15	1710.80.42.410.1	5
Pg 48	56	39.0	43.0	65/66	69	15	1710.80.48.430.1	5
Pg 48	56	43.0	46.5	65/66	69	15	1710.80.48.465.1	5



Je nach Schlauchtyp muss die passende Stabilisierungshülse separat bestellt werden.

Depending on the type of conduit, the stabilising bush must be ordered separately.

Erhältlich mit Dichteinsatz gemäss EN 45545. Bei Anfragen oder Bestellung bitte ein F vor die Artikelnummer setzen.

Available with sealing inserts conformity with EN 45545. When placing an inquiry, prefix the article number by the capital F.

AGRO Adapter Progress® Messing mit integrierter EMV-Kabelverschraubung

AGRO Adapters Progress® nickel-plated brass with integrated EMC cable gland

Langes Anschlussgewinde metrisch | Long entry thread metric

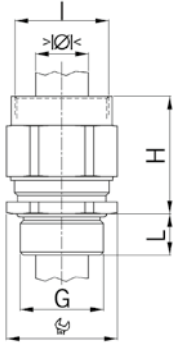

Material:	Messing vernickelt	Material:	Nickel-plated brass
Kontakthülse:	Messing vernickelt	Contact sleeve:	Nickel-plated brass
Dichtung:	TPE	Seal:	TPE
O-Ring:	NBR	O-ring:	NBR
Zugentlastung:	Ausführung A nach EN 62444	Strain relief:	Version A acc. to EN 62444
Schutzart:	Kabelverschraubung IP 68	Protection class:	Cable gland IP 68
Einsatztemperatur:	-40°C / +100°C	Temperature range:	-40°C / +100°C
Hinweis:	Der max. Klemmbereich ist abhängig vom Schlauch-Innendurchmesser	Note:	The max. clamping range depends on the conduit inner diameter
Eigenschaften:	Sehr guter Schirmkontakt über die Kontakthülse bei in der Kabelverschraubung endendem Schirmgeflecht	Properties:	Excellent shield contact through the contact sleeve with the braided shield terminating in the screwed cable gland



Progress MS Kombi EMC



Einteiliger Dichteinsatz nicht durchgehend isolierend		One-piece sealing insert not overall length insulated									
G	I	>Ø< min mm	>Ø< max mm	Ø mm	H mm	L mm	i info	Art.-Nr.	Art. No.	📦	
M10x1.5	M10x1.5	3.0	4.0	13	32	10	1	1165.80.10.040	1165.80.10.060	50	
M10x1.5	M10x1.5	4.0	6.0	13	32	10	1	1165.80.10.060	1165.80.10.060	50	
M12x1.5	M12x1.5	4.5	6.0	15	34	10	-	1165.80.12.060	1165.80.12.075	50	
M12x1.5	M12x1.5	6.0	7.5	15	34	10	-	1165.80.12.075	1165.80.12.075	50	
M16x1.5	M16x1.5	6.0	8.0	18	38	10	-	1165.80.17.080	1165.80.17.100	50	
M16x1.5	M16x1.5	8.0	10.0	18	38	10	-	1165.80.17.100	1165.80.17.100	50	
M20x1.5	M20x1.5	8.0	11.0	24	40	10	-	1165.80.20.110	1165.80.20.140	25	
M20x1.5	M20x1.5	11.0	14.0	24	40	10	-	1165.80.20.140	1165.80.20.140	25	
M25x1.5	M25x1.5	13.0	16.0	30	46	11	-	1165.80.25.160	1165.80.25.190	25	
M25x1.5	M25x1.5	16.0	19.0	30	46	11	-	1165.80.25.190	1165.80.25.190	25	
M32x1.5	M32x1.5	18.0	21.0	36	49	13	-	1165.80.32.210	1165.80.32.250	10	
M32x1.5	M32x1.5	21.0	25.0	36	49	13	-	1165.80.32.250	1165.80.32.250	10	
M40x1.5	M40x1.5	24.0	28.5	46	51	13	-	1165.80.40.285	1165.80.40.320	10	
M40x1.5	M40x1.5	28.5	32.0	46	51	13	-	1165.80.40.320	1165.80.40.320	5	
M50x1.5	M50x1.5	33.0	37.0	55	55	14	-	1165.80.50.370	1165.80.50.410	5	
M50x1.5	M50x1.5	37.0	41.0	55	55	14	-	1165.80.50.410	1165.80.50.410	5	
M63x1.5	M63x1.5	40.0	46.0	70	59	14	-	1165.80.63.460	1165.80.63.500	5	
M63x1.5	M63x1.5	46.0	50.0	70	59	14	-	1165.80.63.500	1165.80.63.500	5	

1 = Metrisches Regelgewinde (mit VDE Testreport)

1 = Metric coarse-pitch thread (with VDE test report)

Erhältlich mit Dichteinsatz gemäss EN 45545. Bei Anfragen oder Bestellung bitte ein F vor die Artikelnummer setzen.

Available with sealing inserts conformity with EN 45545. When placing an inquiry, prefix the article number by the capital F.

AGRO Adapter Progress® Messing mit integrierter EMV-Kabelverschraubung

AGRO Adapters Progress® nickel-plated brass with integrated EMC cable gland

Langes Anschlussgewinde Pg | Filet de raccordement Pg long

Material:	Messing vernickelt	Material:	Nickel-plated brass
Kontakthülse:	Messing vernickelt	Contact sleeve:	Nickel-plated brass
Dichtung:	TPE	Seal:	TPE
O-Ring:	NBR	O-ring:	NBR
Schutzart:	Kabelverschraubung IP 68	Protection class:	Cable gland IP 68
Einsatztemperatur:	-40°C / +100°C	Temperature range:	-40°C / +100°C
Hinweis:	Der max. Klemmbereich ist abhängig vom Schlauch-Innendurchmesser	Note:	The max. clamping range depends on the conduit inner diameter
Eigenschaften:	Sehr guter Schirmkontakt über die Kontakthülse bei in der Kabelverschraubung endendem Schirmgeflecht	Properties:	Excellent shield contact through the contact sleeve with the braided shield terminating in the screwed cable gland

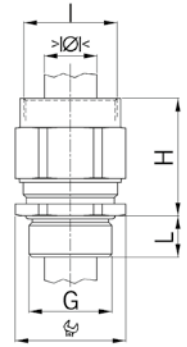

Progress MS Kombi EMC



Einteiliger Dichteinsatz
nicht durchgehend isolierend

One-piece sealing insert
not overall length insulated

G	I	> Ø < min mm	> Ø < max mm	Ø mm	H mm	L mm	Art.-Nr. Art. No.	
Pg 7	Pg 7	4.0	6.0	15	31	10	1165.80.07.060	50
Pg 7	Pg 7	6.0	7.5	15	31	10	1165.80.07.075	50
Pg 9	Pg 9	6.0	8.0	18	38	10	1165.80.09.080	50
Pg 9	Pg 9	8.0	10.0	18	38	10	1165.80.09.100	50
Pg 11	Pg 11	5.5	8.5	21	38	10	1165.80.11.085	50
Pg 11	Pg 11	8.5	12.0	21	38	10	1165.80.11.120	50
Pg 13	Pg 13	8.0	11.0	24	40	10	1165.80.13.110	25
Pg 13	Pg 13	11.0	14.0	24	40	10	1165.80.13.140	25
Pg 16	Pg 16	8.0	11.0	24	41	10	1165.80.16.110	25
Pg 16	Pg 16	11.0	14.0	24	41	10	1165.80.16.140	25
Pg 21	Pg 21	13.0	16.0	30	47	12	1165.80.21.160	10
Pg 21	Pg 21	16.0	19.0	30	47	12	1165.80.21.190	10
Pg 29	Pg 29	19.0	23.0	38/40	48	12	1165.80.29.230	10
Pg 29	Pg 29	23.0	25.5	38/40	48	12	1165.80.29.255	10
Pg 36	Pg 36	25.0	30.5	50	54	15	1165.80.36.305	10
Pg 36	Pg 36	30.5	35.0	50	54	15	1165.80.36.350	10
Pg 48	Pg 48	39.0	43.0	65	59	15	1165.80.48.430	5
Pg 48	Pg 48	43.0	46.5	65	59	15	1165.80.48.465	5



Erhältlich mit Dichteinsatz gemäss EN 45545. Bei Anfragen oder Bestellung bitte ein F vor die Artikelnummer setzen.

Available with sealing inserts conformity with EN 45545. When placing an inquiry, prefix the article number by the capital F.

AGRO Kombi-EMV-Schlauchverschraubung für Kupfer-Hohlgeflechte

AGRO combination EMC conduit gland for copper braidings

Anschlussgewinde metrisch | Filet de raccordement métrique

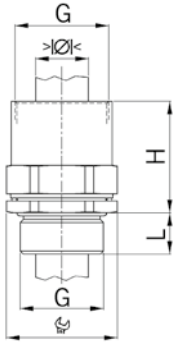

Material: Messing vernickelt
 Kontakthülse: Messing vernickelt
 O-Ring: NBR
 Schutzart: IP 68 (mit ROHRflex®-Ringwellschlauch)

Einsatztemperatur: -40°C / +120°C
 Eigenschaften: Dank unserer Kombi-EMV-Schlauchverschraubung für Kupfer-Hohlgeflechte können die Geflechte problemlos auf Masse geführt werden. Eine Kontakthülse garantiert optimale und ausreissfeste Schirmkontaktierung und gleichzeitig eine vibrationsichere Einführung.

Material: Nickel-plated brass
 Contact sleeve: Nickel-plated brass
 O-ring: NBR
 Protection class: IP 68 (together with ROHRflex® corrugated tube)

Temperature range: -40°C / +120°C
 Properties: Copper braidings may be terminated without any problem with our combination EMC conduit gland. A contact bushing grants optimal shield contact at the same time vibration-proof leading of cables.



Passend zu ROHRflex® Wellschlauch

Suitable for ROHRflex® corrugated tubings

G	>Ø<		Ø	H	L	Art.-Nr. Art. No.		📦
	min mm	max mm						
M20x1.5	2.5	10.0	24	34.5	10	1165.84.20.15	25	
M25x1.5	5.0	16.0	30	35.5	11	1165.84.25.21	25	
M32x1.5	12.0	20.0	36	36.5	13	1165.84.32.34	25	
M40x1.5	16.0	27.0	46	45	13	1165.84.40.34	10	
M50x1.5	20.0	35.0	55	46	14	1165.84.50.42	5	
M63x1.5	25.0	45.0	70	49	14	1165.84.63.54	5	



Druckring Messing zu Schlauchverschraubungen | Thrust collar brass for conduit glands

Material: Messing vernickelt
 Einsatzbereich: Zur Erdung sowie als Potenzialausgleich bei Verwendung von Schläuchen mit Metallgeflecht im EMV-Einsatz
 Einsatztemperatur: -40°C / +250°C

Material: Nickel-plated brass
 Application: For grounding as well as potential equalization by use of conduits with metal braiding for shielding applications
 Temperature range: -40°C / +250°C

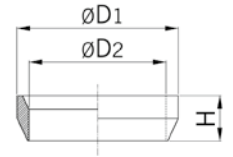

Zubehör zu Schlauchverschraubungen Messing-Druckring				Conduit glands accessories Thrust collar brass	
AD mm	ØD1 mm	ØD2 mm	H mm	Art.-Nr. Art. No.	
10	13	10.2	5.0	5031.034.007	50
14	17	14.5	5.0	5031.034.009	50
17	21	17.2	5.0	5031.034.011	50
19	23	19.2	6.0	5031.034.013	50
21	25	21.3	6.0	5031.034.016	50
27	32	27.3	8.5	5031.034.021	25
36	41	36.3	8.5	5031.034.029	25
45	50	45.3	8.5	5031.034.036	20
56	61	56.3	8.5	5031.034.048	10

Für EMV-Anwendungen Messingdruckring erforderlich! For EMC applications brass thrust collar necessary!



Dichting Kunststoff zu Schlauchverschraubungen | Synthetic thrust collar for conduit glands

Material: PTFE (Teflon)
 Einsatzbereich: Bei Verwendung von Schutzschläuchen mit Verschraubungen, geeignet für hohe Temperaturen
 Einsatztemperatur: -60°C / +300°C

Material: PTFE (teflon)
 Application: By using tubes with conduit glands suitable for high temperatures
 Temperature range: -60°C / +300°C

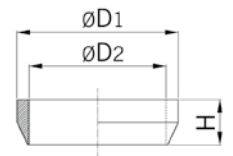

Zubehör zu Schlauchverschraubungen Dichting				Conduit glands accessories Sealing ring	
AD mm	ØD1 mm	ØD2 mm	H mm	Art.-Nr. Art. No.	
10	13	10.3	6.0	5030.013.010	50
14	17	14.3	6.0	5030.013.014	50
17	21	17.3	6.0	5030.013.017	50
21	25	21.3	7.0	5030.013.021	50
27	32	27.4	9.5	5030.013.027	25
36	41	36.4	9.5	5030.013.036	25
45	50	45.4	9.5	5030.013.045	20
56	61	56.5	9.5	5030.013.056	10

Für hohe Temperaturen For high temperature applications



Kabelverschraubung Progress® Kunststoff

Synthetic cable glands Progress®

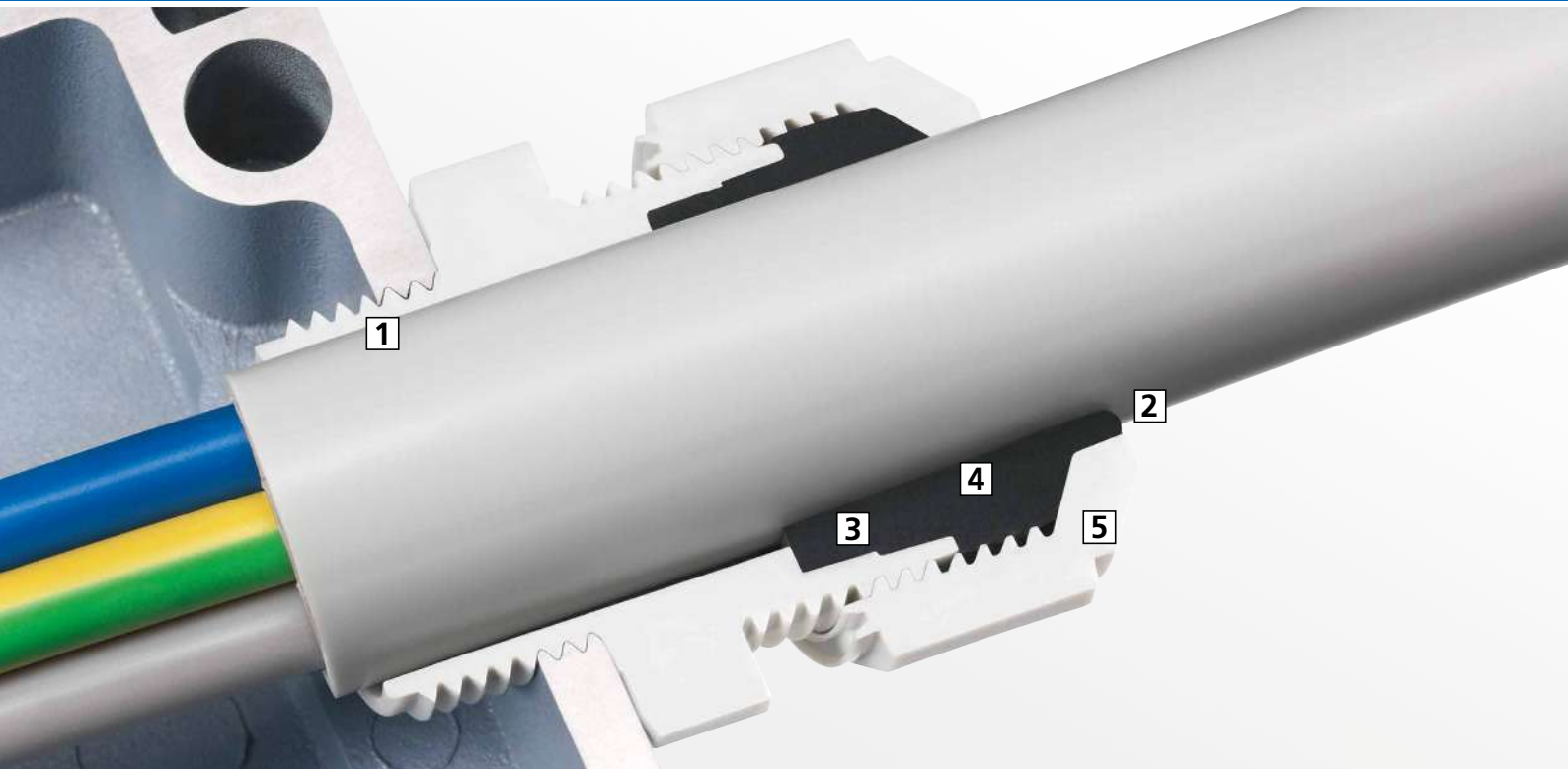

Kabelverschraubungen Progress® aus Kunststoff sind bewährte Helfer für die fachgerechte Kabeleinführung in Industrieanlagen. Die herausragende Kompressionstechnik sorgt für eine hohe Dichtigkeit und eine äusserst kabelschonende Zugentlastung.

1 Kurzes oder langes Anschlussgewinde

Kompressionskabelverschraubungen mit kurzem oder langem Anschlussgewinde in metrischer oder Pg- Ausführung können bei vorhandenem Öffnungsgewinde oder mit Gegenmutter verwendet werden.

2 Sichtbare Sicherheit

Der kleine Wulst des Dichteinsatzes bestätigt das richtige Anzugsmoment.

3 Hoher Verdrehenschutz

Der mit Halterippen ausgestattete Dichteinsatz sorgt für einen hohen Verdrehenschutz.

4 Grosse Flexibilität

Zweiteilige Dichteinsätze können in Sekundenschnelle vor Ort auf den vorhandenen Kabeldurchmesser angepasst werden.

5 Garantierte Dichtigkeit

Auf den Dichteinsatz abgestimmte Innenkonturen sorgen für eine zielgerichtete Verformung des Dichteinsatzes und garantieren somit dessen perfekte Abdichtung.

Synthetic cable glands Progress® are tried and tested helpers for correct cable entry in industrial equipment.

The outstanding compression technology for use everywhere guarantees an effective seal and excellent cable-protecting strain relief.

1 Short or long connection thread

Compression cable glands with short or long connection thread designed as metric or Pg can be used with existing opening threads or with a counter nut.

2 Visible safety

The small bulge in the sealing insert confirms the correct tightening torque.

3 High distortion protection

The sealing insert fitted with retaining ribs guarantees high distortion protection.

4 Great flexibility

It only takes a few seconds to adapt the two-part sealing inserts on site to the existing cable diameters.

5 Guaranteed seal

The inner contours of the sealing inserts ensure that they are deformed in such a way as to make the perfect seal.

Dichteinsätze

Sealing inserts



einteiliger Dichteinsatz
One-piece sealing insert



zweiteiliger Dichteinsatz
Two-piece sealing insert



Kabelverschraubungen Progress® Kunststoff GFK
 Synthetic cable glands Progress® GFK



174 - 181

Kabelverschraubungen Progress® Kunststoff GFK für mehrere Kabel
 Synthetic cable glands Progress® GFK for installation of multiple cables



182 - 183

Progress® Kunststoff
Progress® Synthetic

Standard
Standard

für mehrere Kabel
for installation of multiple cables

Ausführung / Version			
Kompressionstechnik Compression technology		•	•
Gewinde / Thread			
Anschlussgewinde metrisch Entry thread metric		•	•
Anschlussgewinde Pg Entry thread Pg		•	•
Langes Anschlussgewinde Long entry thread		-	-
Dichteinsatz / Sealing insert			
für Rundkabel for round cables		•	•
für mehrere Kabel (Multi-Dichteinsatz) for multi sealing insert		•	•
einteiliger Dichteinsatz One-piece sealing insert		•	•
zweiteiliger Dichteinsatz Two-piece sealing insert		•	-
Technische Besonderheiten / Technical features			
Vibrationsschutz Vibration resistance		•	•
Farben / Colours			
Hellgrau RAL 7035 Light grey RAL 7035		•	•
Dunkelgrau RAL 7001 Dark grey RAL 7001		•	•
Schwarz RAL 9005 Black RAL 9005		•	•
Weiss RAL 9010 White RAL 9010		•	-
Graugrün RAL 7009 Greengreen RAL 7009		•	-

1
2
3
4
5
6
7
8
9
10
11
12

Kabelverschraubungen Progress® Kunststoff GFK

Synthetic cable glands Progress® GFK

Anschlussgewinde metrisch | Entry thread metric

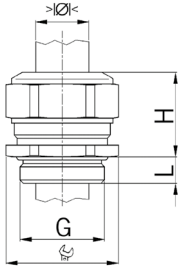

Material: Polyamid glasfaserverstärkt
 Eigenschaften: halogenfrei
 Dichtung: TPE
 Zugentlastung: Ausführung A nach EN 62444
 Einsatztemperatur: -20°C / +100°C
 Schutzart: IP 68

Material: Polyamide glass fiber reinforced
 Properties: halogen-free
 Seal: TPE
 Strain relief: Version A acc. to EN 62444
 Temperature range: -20°C / +100°C
 Protection class: IP 68



Progress GFK

Hellgrau RAL 7035
 Einteiliger Dichteinsatz

Light grey RAL 7035
 One-piece sealing insert

G	>Ø< min mm	>Ø< max mm	Ø mm	H mm	L mm	Art.-Nr. Art. No.	
M8x1.0	2.5	3.5	12	15.5	10	1571.08.035	50
M8x1.0	3.5	5.0	12	15.5	10	1571.08.050	50
M10x1.0	3.0	4.0	15	18.0	10	1571.10.040	50
M10x1.0	4.0	6.0	15	18.0	10	1571.10.060	50
M12x1.5	3.5	5.0	17	22.0	12	1571.12.050	50
M12x1.5	5.0	6.5	17	22.0	12	1571.12.065	50
M12x1.5	6.5	8.0	17	22.0	12	1571.12.080	50
M16x1.5	4.5	6.0	21	26.0	12	1571.17.060	50
M16x1.5	6.0	8.0	21	26.0	12	1571.17.080	50
M16x1.5	8.0	10.5	21	26.0	12	1571.17.105	50
M20x1.5	6.0	8.0	27	28.0	13	1571.20.080	50
M20x1.5	8.0	11.0	27	28.0	13	1571.20.110	50
M20x1.5	11.0	15.0	27	28.0	13	1571.20.150	50
M25x1.5	9.5	12.5	34	33.0	13	1571.25.125	25
M25x1.5	12.5	16.0	34	33.0	13	1571.25.160	25
M25x1.5	16.0	20.5	34	33.0	13	1571.25.205	25
M32x1.5	14.0	17.0	41	35.0	15	1571.32.170	25
M32x1.5	17.0	21.0	41	35.0	15	1571.32.210	25
M32x1.5	21.0	25.5	41	35.0	15	1571.32.255	25
M40x1.5	20.0	24.0	50	40.0	15	1571.40.240	10
M40x1.5	24.0	28.5	50	40.0	15	1571.40.285	10
M40x1.5	28.5	33.0	50	40.0	15	1571.40.330	10
M50x1.5	29.0	33.0	60	42.0	16	1571.50.330	10
M50x1.5	33.0	37.0	60	42.0	16	1571.50.370	10
M50x1.5	37.0	42.0	60	42.0	16	1571.50.420	10
M63x1.5	35.0	40.0	75	48.0	16	1571.63.400	5
M63x1.5	40.0	46.0	75	48.0	16	1571.63.460	5
M63x1.5	46.0	52.0	75	48.0	16	1571.63.520	5



Progress GFK

Hellgrau RAL 7035
 Zweiteiliger Dichteinsatz

Light grey RAL 7035
 Two-piece sealing insert

G	>Ø< min mm	>Ø< max mm	>Ø< min mm	>Ø< max mm	Ø mm	H mm	L mm	Art.-Nr. Art. No.	
M16x1.5	6.0	8.0	8.0	10.5	21	26.0	12	1571.17	50
M20x1.5	8.0	11.0	11.0	15.0	27	28.0	13	1571.20	50
M25x1.5	12.5	16.0	16.0	20.5	34	33.0	13	1571.25	25
M32x1.5	17.0	21.0	21.0	25.5	41	35.0	15	1571.32	25
M40x1.5	24.0	28.5	28.5	33.0	50	40.0	15	1571.40	10
M50x1.5	33.0	37.0	37.0	42.0	60	42.0	16	1571.50	10
M63x1.5	40.0	46.0	46.0	52.0	75	48.0	16	1571.63	5

Kabelverschraubungen Progress® Kunststoff GFK

Synthetic cable glands Progress® GFK

Anschlussgewinde metrisch | Filet de raccordement métrique

Material: Agromid glasfaserverstärkt, wärmealterungs- und schlagzäh modifiziert
 Eigenschaften: halogenfrei
 Dichtung: TPE
 Zugentlastung: Ausführung A nach EN 62444
 Einsatztemperatur: -30°C / +100°C
 Schutzart: IP 68

Material: Agromid glass fiber reinforced, heat aging and impact-resistant modified
 Properties: halogen-free
 Seal: TPE
 Strain relief: Version A acc. to EN 62444
 Temperature range: -30°C / +100°C
 Protection class: IP 68

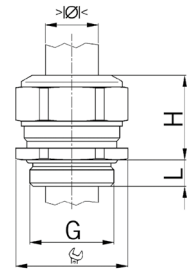

Progress GFK

Dunkelgrau RAL 7001 Einteiliger Dichteinsatz		Dark grey RAL 7001 One-piece sealing insert		Art.-Nr. Art. No.			
G	>Ø< min mm	>Ø< max mm	 mm	H mm	L mm		
M8x1.0	2.5	3.5	12	15.5	10	1572.08.035	50
M8x1.0	3.5	5.0	12	15.5	10	1572.08.050	50
M10x1.0	3.0	4.0	15	18.0	10	1572.10.040	50
M10x1.0	4.0	6.0	15	18.0	10	1572.10.060	50
M12x1.5	3.5	5.0	17	22.0	12	1572.12.050	50
M12x1.5	5.0	6.5	17	22.0	12	1572.12.065	50
M12x1.5	6.5	8.0	17	22.0	12	1572.12.080	50
M16x1.5	4.5	6.0	21	26.0	12	1572.17.060	50
M16x1.5	6.0	8.0	21	26.0	12	1572.17.080	50
M16x1.5	8.0	10.5	21	26.0	12	1572.17.105	50
M20x1.5	6.0	8.0	27	28.0	13	1572.20.080	50
M20x1.5	8.0	11.0	27	28.0	13	1572.20.110	50
M20x1.5	11.0	15.0	27	28.0	13	1572.20.150	50
M25x1.5	9.5	12.5	34	33.0	13	1572.25.125	25
M25x1.5	12.5	16.0	34	33.0	13	1572.25.160	25
M25x1.5	16.0	20.5	34	33.0	13	1572.25.205	25
M32x1.5	14.0	17.0	41	35.0	15	1572.32.170	25
M32x1.5	17.0	21.0	41	35.0	15	1572.32.210	25
M32x1.5	21.0	25.5	41	35.0	15	1572.32.255	25
M40x1.5	20.0	24.0	50	40.0	15	1572.40.240	10
M40x1.5	24.0	28.5	50	40.0	15	1572.40.285	10
M40x1.5	28.5	33.0	50	40.0	15	1572.40.330	10
M50x1.5	29.0	33.0	60	42.0	16	1572.50.330	10
M50x1.5	33.0	37.0	60	42.0	16	1572.50.370	10
M50x1.5	37.0	42.0	60	42.0	16	1572.50.420	10
M63x1.5	35.0	40.0	75	48.0	16	1572.63.400	5
M63x1.5	40.0	46.0	75	48.0	16	1572.63.460	5
M63x1.5	46.0	52.0	75	48.0	16	1572.63.520	5



Progress GFK

Dunkelgrau RAL 7001 Zweiteiliger Dichteinsatz		Dark grey RAL 7001 Two-piece sealing insert		Art.-Nr. Art. No.					
G	>Ø< min mm	>Ø< max mm	>Ø< min mm	>Ø< max mm	 mm	H mm	L mm		
M16x1.5	6.0	8.0	8.0	10.5	21	26.0	12	1572.17	50
M20x1.5	8.0	11.0	11.0	15.0	27	28.0	13	1572.20	50
M25x1.5	12.5	16.0	16.0	20.5	34	33.0	13	1572.25	25
M32x1.5	17.0	21.0	21.0	25.5	41	35.0	15	1572.32	25
M40x1.5	24.0	28.5	28.5	33.0	50	40.0	15	1572.40	10
M50x1.5	33.0	37.0	37.0	42.0	60	42.0	16	1572.50	10
M63x1.5	40.0	46.0	46.0	52.0	75	48.0	16	1572.63	5



Kabelverschraubungen Progress® Kunststoff GFK

Synthetic cable glands Progress® GFK

Anschlussgewinde metrisch | Entry thread metric

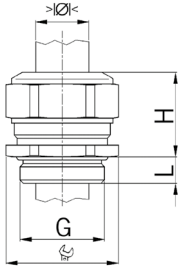

Material: Polyamid glasfaserverstärkt
 Eigenschaften: halogenfrei
 Dichtung: TPE
 Zugentlastung: Ausführung A nach EN 62444
 Einsatztemperatur: -20°C / +100°C
 Schutzart: IP 68

Material: Polyamide glass fiber reinforced
 Properties: halogen-free
 Seal: TPE
 Strain relief: Version A acc. to EN 62444
 Temperature range: -20°C / +100°C
 Protection class: IP 68



Progress GFK

Schwarz RAL 9005
 Einteiliger Dichteinsatz

Black RAL 9005
 One-piece sealing insert

G	> Ø < min mm	> Ø < max mm	mm	H mm	L mm	Art.-Nr. Art. No.	
M8x1.0	2.5	3.5	12	15.5	10	1540.08.035	50
M8x1.0	3.5	5.0	12	15.5	10	1540.08.050	50
M10x1.0	3.0	4.0	15	18.0	10	1540.10.040	50
M10x1.0	4.0	6.0	15	18.0	10	1540.10.060	50
M12x1.5	3.5	5.0	17	22.0	12	1540.12.050	50
M12x1.5	5.0	6.5	17	22.0	12	1540.12.065	50
M12x1.5	6.5	8.0	17	22.0	12	1540.12.080	50
M16x1.5	4.5	6.0	21	26.0	12	1540.17.060	50
M16x1.5	6.0	8.0	21	26.0	12	1540.17.080	50
M16x1.5	8.0	10.5	21	26.0	12	1540.17.105	50
M20x1.5	6.0	8.0	27	28.0	13	1540.20.080	50
M20x1.5	8.0	11.0	27	28.0	13	1540.20.110	50
M20x1.5	11.0	15.0	27	28.0	13	1540.20.150	50
M25x1.5	9.5	12.5	34	33.0	13	1540.25.125	25
M25x1.5	12.5	16.0	34	33.0	13	1540.25.160	25
M25x1.5	16.0	20.5	34	33.0	13	1540.25.205	25
M32x1.5	14.0	17.0	41	35.0	15	1540.32.170	25
M32x1.5	17.0	21.0	41	35.0	15	1540.32.210	25
M32x1.5	21.0	25.5	41	35.0	15	1540.32.255	25
M40x1.5	20.0	24.0	50	40.0	15	1540.40.240	10
M40x1.5	24.0	28.5	50	40.0	15	1540.40.285	10
M40x1.5	28.5	33.0	50	40.0	15	1540.40.330	10
M50x1.5	29.0	33.0	60	42.0	16	1540.50.330	10
M50x1.5	33.0	37.0	60	42.0	16	1540.50.370	10
M50x1.5	37.0	42.0	60	42.0	16	1540.50.420	10
M63x1.5	35.0	40.0	75	48.0	16	1540.63.400	5
M63x1.5	40.0	46.0	75	48.0	16	1540.63.460	5
M63x1.5	46.0	52.0	75	48.0	16	1540.63.520	5



Progress GFK

Schwarz RAL 9005
 Zweiteiliger Dichteinsatz

Black RAL 9005
 Two-piece sealing insert

G	> Ø < min mm	> Ø < max mm	> Ø < min mm	> Ø < max mm	mm	H mm	L mm	Art.-Nr. Art. No.	
M16x1.5	6.0	8.0	8.0	10.5	21	26.0	12	1540.17	50
M20x1.5	8.0	11.0	11.0	15.0	27	28.0	13	1540.20	50
M25x1.5	12.5	16.0	16.0	20.5	34	33.0	13	1540.25	25
M32x1.5	17.0	21.0	21.0	25.5	41	35.0	15	1540.32	25
M40x1.5	24.0	28.5	28.5	33.0	50	40.0	15	1540.40	10
M50x1.5	33.0	37.0	37.0	42.0	60	42.0	16	1540.50	10
M63x1.5	40.0	46.0	46.0	52.0	75	48.0	16	1540.63	5

Anschlussgewinde metrisch | Entry thread metric

Material: Polyamid glasfaserverstärkt
 Eigenschaften: halogenfrei
 Dichtung: TPE
 Zugentlastung: Ausführung A nach EN 62444
 Einsatztemperatur: -20°C / +100°C
 Schutzart: IP 68

Material: Polyamide glass fiber reinforced
 Properties: halogen-free
 Seal: TPE
 Strain relief: Version A acc. to EN 62444
 Temperature range: -20°C / +100°C
 Protection class: IP 68

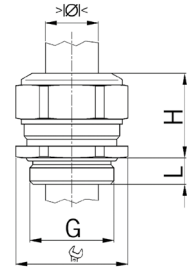

Progress GFK

Weiss RAL 9010 Einteiliger Dichteinsatz		White RAL 9010 One-piece sealing insert		Art.-Nr. Art. No.		
G	>Ø< min mm	>Ø< max mm	 mm	H mm	L mm	
M20x1.5	6.0	8.0	27	28	13	50
M20x1.5	8.0	11.0	27	28	13	50



Progress GFK

Weiss RAL 9010 Zweiteiliger Dichteinsatz		White RAL 9010 Two-piece sealing insert		Art.-Nr. Art. No.				
G	>Ø< min mm	>Ø< max mm	>Ø< min mm	>Ø< max mm	 mm	H mm	L mm	
M16x1.5	6.0	8.0	8.0	10.5	21	26	12	50
M20x1.5	8.0	11.0	11.0	15.0	27	28	13	50
M25x1.5	12.5	16.0	16.0	20.5	34	33	13	25



Progress GFK

Graugrün RAL 7009 Zweiteiliger Dichteinsatz		Greygreen RAL 7009 Two-piece sealing insert		Art.-Nr. Art. No.				
G	>Ø< min mm	>Ø< max mm	>Ø< min mm	>Ø< max mm	 mm	H mm	L mm	
M16x1.5	6.0	8.0	8.0	10.5	21	26	12	50
M20x1.5	8.0	11.0	11.0	15.0	27	28	13	50
M25x1.5	12.5	16.0	16.0	20.5	34	33	13	25
M32x1.5	17.0	21.0	21.0	25.5	41	35	15	25



1
2
3
4
5
6
7
8
9
10
11
12

Kabelverschraubungen Progress® Kunststoff GFK

Synthetic cable glands Progress® GFK

Anschlussgewinde Pg | Entry thread Pg

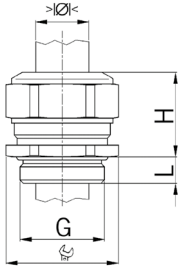

Material: Polyamid glasfaserverstärkt
 Eigenschaften: halogenfrei
 Dichtung: TPE
 Einsatztemperatur: -20°C / +100°C
 Schutzart: IP 68

Material: Polyamide glass fiber reinforced
 Properties: halogen-free
 Seal: TPE
 Temperature range: -20°C / +100°C
 Protection class: IP 68



Progress GFK



Hellgrau RAL 7035

Light grey RAL 7035

Einteiliger Dichteinsatz

One-piece sealing insert

G	>Ø< min mm	>Ø< max mm	Ø mm	H mm	L mm	Art.-Nr. Art. No.	
Pg 7	3.5	5.0	17	22	12	1571.07.050	50
Pg 7	5.0	6.5	17	22	12	1571.07.065	50
Pg 7	6.5	8.0	17	22	12	1571.07.080	50
Pg 9	4.5	6.0	21	26	12	1571.09.060	50
Pg 9	6.0	8.0	21	26	12	1571.09.080	50
Pg 9	8.0	10.5	21	26	12	1571.09.105	50
Pg 11	4.0	5.5	24	28	12	1571.11.055	50
Pg 11	5.5	8.5	24	28	12	1571.11.085	50
Pg 11	8.5	12.0	24	28	12	1571.11.120	50
Pg 13	6.0	8.0	27	28	13	1571.13.080	50
Pg 13	8.0	11.0	27	28	13	1571.13.110	50
Pg 13	11.0	15.0	27	28	13	1571.13.150	50
Pg 16	6.0	8.0	27	28	13	1571.16.080	50
Pg 16	8.0	11.0	27	28	13	1571.16.110	50
Pg 16	11.0	15.0	27	28	13	1571.16.150	50
Pg 21	9.5	12.5	34	33	13	1571.21.125	25
Pg 21	12.5	16.0	34	33	13	1571.21.160	25
Pg 21	16.0	20.5	34	33	13	1571.21.205	25
Pg 29	16.0	19.0	41	36	13	1571.29.190	25
Pg 29	19.0	23.0	41	36	13	1571.29.230	25
Pg 29	23.0	27.5	41	36	13	1571.29.275	25
Pg 36	21.5	26.0	55	42	16	1571.36.260	10
Pg 36	26.0	30.5	55	42	16	1571.36.305	10
Pg 36	30.5	35.0	55	42	16	1571.36.350	10
Pg 42	29.0	33.0	60	42	16	1571.42.330	10
Pg 42	33.0	37.0	60	42	16	1571.42.370	10
Pg 42	37.0	42.0	60	42	16	1571.42.420	10
Pg 48	32.0	37.0	70	46	16	1571.48.370	5
Pg 48	37.0	43.0	70	46	16	1571.48.430	5
Pg 48	43.0	49.0	70	46	16	1571.48.490	5



Progress GFK



Hellgrau RAL 7035

Light grey RAL 7035

Zweiteiliger Dichteinsatz

Two-piece sealing insert

G	>Ø< min mm	>Ø< max mm	>Ø< min mm	>Ø< max mm	Ø mm	H mm	L mm	Art.-Nr. Art. No.	
Pg 9	6.0	8.0	8.0	10.5	21	26	12	1571.09	50
Pg 11	5.5	8.5	8.5	12.0	24	28	12	1571.11	50
Pg 13	8.0	11.0	11.0	15.0	27	28	13	1571.13	50
Pg 16	8.0	11.0	11.0	15.0	27	28	13	1571.16	50
Pg 21	12.5	16.0	16.0	20.5	34	33	13	1571.21	25
Pg 29	19.0	23.0	23.0	27.5	41	36	13	1571.29	25
Pg 36	26.0	30.5	30.5	35.0	55	42	16	1571.36	10
Pg 42	33.0	37.0	37.0	42.0	60	42	16	1571.42	10
Pg 48	37.0	43.0	43.0	49.0	70	46	16	1571.48	5

Kabelverschraubungen Progress® Kunststoff GFK

Synthetic cable glands Progress® GFK

Anschlussgewinde Pg | Entry thread Pg

Material: Agromid glasfaserverstärkt, wärmealterungs- und schlagzäh modifiziert
 Eigenschaften: halogenfrei
 Dichtung: TPE
 Einsatztemperatur: -30°C / +100°C
 Schutzart: IP 68

Material: Agromid glass fiber reinforced, heat aging and impact-resistant modified
 Properties: halogen-free
 Seal: TPE
 Temperature range: -30°C / +100°C
 Protection class: IP 68

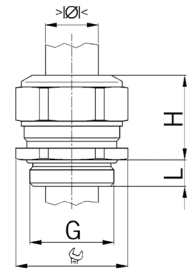

Progress GFK



Dunkelgrau RAL 7001 Einteiliger Dichteinsatz		Dark grey RAL 7001 One-piece sealing insert		Art.-Nr. Art. No.			
G	>Ø< min mm	>Ø< max mm	 mm	H mm	L mm		
Pg 7	3.5	5.0	17	22	12	1572.07.050	50
Pg 7	5.0	6.5	17	22	12	1572.07.065	50
Pg 7	6.5	8.0	17	22	12	1572.07.080	50
Pg 9	4.5	6.0	21	26	12	1572.09.060	50
Pg 9	6.0	8.0	21	26	12	1572.09.080	50
Pg 9	8.0	10.5	21	26	12	1572.09.105	50
Pg 11	4.0	5.5	24	28	12	1572.11.055	50
Pg 11	5.5	8.5	24	28	12	1572.11.085	50
Pg 11	8.5	12.0	24	28	12	1572.11.120	50
Pg 13	6.0	8.0	27	28	13	1572.13.080	50
Pg 13	8.0	11.0	27	28	13	1572.13.110	50
Pg 13	11.0	15.0	27	28	13	1572.13.150	50
Pg 16	6.0	8.0	27	28	13	1572.16.080	50
Pg 16	8.0	11.0	27	28	13	1572.16.110	50
Pg 16	11.0	15.0	27	28	13	1572.16.150	50
Pg 21	9.5	12.5	34	33	13	1572.21.125	25
Pg 21	12.5	16.0	34	33	13	1572.21.160	25
Pg 21	16.0	20.5	34	33	13	1572.21.205	25
Pg 29	16.0	19.0	41	36	13	1572.29.190	25
Pg 29	19.0	23.0	41	36	13	1572.29.230	25
Pg 29	23.0	27.5	41	36	13	1572.29.275	25
Pg 36	21.5	26.0	55	42	16	1572.36.260	10
Pg 36	26.0	30.5	55	42	16	1572.36.305	10
Pg 36	30.5	35.0	55	42	16	1572.36.350	10
Pg 42	29.0	33.0	60	42	16	1572.42.330	10
Pg 42	33.0	37.0	60	42	16	1572.42.370	10
Pg 42	37.0	42.0	60	42	16	1572.42.420	10
Pg 48	32.0	37.0	70	46	16	1572.48.370	5
Pg 48	37.0	43.0	70	46	16	1572.48.430	5
Pg 48	43.0	49.0	70	46	16	1572.48.490	5



Progress GFK



Dunkelgrau RAL 7001 Zweiteiliger Dichteinsatz		Dark grey RAL 7001 Two-piece sealing insert		Art.-Nr. Art. No.					
G	>Ø< min mm	>Ø< max mm	>Ø< min mm	>Ø< max mm	 mm	H mm	L mm		
Pg 9	6.0	8.0	8.0	10.5	21	26	12	1572.09	50
Pg 11	5.5	8.5	8.5	12.0	24	28	12	1572.11	50
Pg 13	8.0	11.0	11.0	15.0	27	28	13	1572.13	50
Pg 16	8.0	11.0	11.0	15.0	27	28	13	1572.16	50
Pg 21	12.5	16.0	16.0	20.5	34	33	13	1572.21	25
Pg 29	19.0	23.0	23.0	27.5	41	36	13	1572.29	25
Pg 36	26.0	30.5	30.5	35.0	55	42	16	1572.36	10
Pg 42	33.0	27.0	27.0	42.0	60	42	16	1572.42	10
Pg 48	37.0	43.0	43.0	49.0	70	46	16	1572.48	5



Kabelverschraubungen Progress® Kunststoff GFK

Synthetic cable glands Progress® GFK

Anschlussgewinde Pg | Entry thread Pg

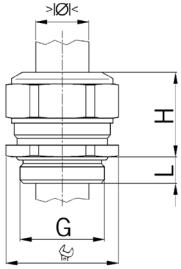

Material: Polyamid glasfaserverstärkt
 Eigenschaften: halogenfrei
 Dichtung: TPE
 Einsatztemperatur: -20°C / +100°C
 Schutzart: IP 68

Material: Polyamide glass fiber reinforced
 Properties: halogen-free
 Seal: TPE
 Temperature range: -20°C / +100°C
 Protection class: IP 68



Progress GFK

Schwarz RAL 9005

Einteiliger Dichteinsatz

Black RAL 9005

One-piece sealing insert

G	>Ø< min mm	>Ø< max mm	Ø _{fl} mm	H mm	L mm	Art.-Nr. Art. No.	
Pg 7	3.5	5.0	17	22	12	1540.07.050	50
Pg 7	5.0	6.5	17	22	12	1540.07.065	50
Pg 7	6.5	8.0	17	22	12	1540.07.080	50
Pg 9	4.5	6.0	21	26	12	1540.09.060	50
Pg 9	6.0	8.0	21	26	12	1540.09.080	50
Pg 9	8.0	10.5	21	26	12	1540.09.105	50
Pg 11	4.0	5.5	24	28	12	1540.11.055	50
Pg 11	5.5	8.5	24	28	12	1540.11.085	50
Pg 11	8.5	12.0	24	28	12	1540.11.120	50
Pg 13	6.0	8.0	27	28	13	1540.13.080	50
Pg 13	8.0	11.0	27	28	13	1540.13.110	50
Pg 13	11.0	15.0	27	28	13	1540.13.150	50
Pg 16	6.0	8.0	27	28	13	1540.16.080	50
Pg 16	8.0	11.0	27	28	13	1540.16.110	50
Pg 16	11.0	15.0	27	28	13	1540.16.150	50
Pg 21	9.5	12.5	34	33	13	1540.21.125	25
Pg 21	12.5	16.0	34	33	13	1540.21.160	25
Pg 21	16.0	20.5	34	33	13	1540.21.205	25
Pg 29	16.0	19.0	41	36	13	1540.29.190	25
Pg 29	19.0	23.0	41	36	13	1540.29.230	25
Pg 29	23.0	27.5	41	36	13	1540.29.275	25
Pg 36	21.5	26.0	55	42	16	1540.36.260	10
Pg 36	26.0	30.5	55	42	16	1540.36.305	10
Pg 36	30.5	35.0	55	42	16	1540.36.350	10
Pg 42	29.0	33.0	60	42	16	1540.42.330	10
Pg 42	33.0	37.0	60	42	16	1540.42.370	10
Pg 42	37.0	42.0	60	42	16	1540.42.420	10
Pg 48	32.0	37.0	70	46	16	1540.48.370	5
Pg 48	37.0	43.0	70	46	16	1540.48.430	5
Pg 48	43.0	49.0	70	46	16	1540.48.490	5

Progress GFK

Schwarz RAL 9005

Zweiteiliger Dichteinsatz

Black RAL 9005

Two-piece sealing insert



G	>Ø< min mm	>Ø< max mm	>Ø< min mm	>Ø< max mm	Ø _{fl} mm	H mm	L mm	Art.-Nr. Art. No.	
Pg 9	6.0	8.0	8.0	10.5	21	26	12	1540.09	50
Pg 11	5.5	8.5	8.5	12.0	24	28	12	1540.11	50
Pg 13	8.0	11.0	11.0	15.0	27	28	13	1540.13	50
Pg 16	8.0	11.0	11.0	15.0	27	28	13	1540.16	50
Pg 21	12.5	16.0	16.0	20.5	34	33	13	1540.21	25
Pg 29	19.0	23.0	23.0	27.5	41	36	13	1540.29	25
Pg 36	26.0	30.5	30.5	35.0	55	42	16	1540.36	10
Pg 42	33.0	37.0	37.0	42.0	60	42	16	1540.42	10
Pg 48	37.0	43.0	43.0	49.0	70	46	16	1540.48	5

Kabelverschraubungen Progress® Kunststoff GFK

Synthetic cable glands Progress® GFK

Anschlussgewinde Pg | Entry thread Pg

Material: Polyamid glasfaserverstärkt
 Eigenschaften: halogenfrei
 Dichtung: TPE
 Einsatztemperatur: -20°C / +100°C
 Schutzart: IP 68

Material: Polyamide glass fiber reinforced
 Properties: halogen-free
 Seal: TPE
 Temperature range: -20°C / +100°C
 Protection class: IP 68

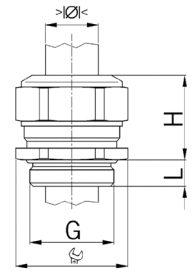

Progress GFK



Weiss RAL 9010 Einteiliger Dichteinsatz		White RAL 9010 One-piece sealing insert		Art.-Nr. Art. No.		
G	>Ø< min mm	>Ø< max mm	 mm	H mm	L mm	
Pg 16	6.0	8.0	27	28	13	50
Pg 16	8.0	11.0	27	28	13	50



Progress GFK



Weiss RAL 9010 Zweiteiliger Dichteinsatz		White RAL 9010 Two-piece sealing insert		Art.-Nr. Art. No.				
G	>Ø< min mm	>Ø< max mm	>Ø< min mm	>Ø< max mm	 mm	H mm	L mm	
Pg 11	5.5	8.5	8.5	12.0	24	28	12	50
Pg 16	8.0	11.0	11.0	15.0	27	28	13	50



Progress GFK



Graugrün RAL 7009 Zweiteiliger Dichteinsatz		Greygreen RAL 7009 Two-piece sealing insert		Art.-Nr. Art. No.				
G	>Ø< min mm	>Ø< max mm	>Ø< min mm	>Ø< max mm	 mm	H mm	L mm	
Pg 9	6.0	8.0	8.0	10.5	21	26	12	50
Pg 11	5.5	8.5	8.5	12.0	24	28	12	50
Pg 13	8.0	8.0	8.0	15.0	27	28	13	50
Pg 16	8.0	11.0	11.0	15.0	27	28	13	50
Pg 21	12.5	16.0	16.0	20.5	34	33	13	25
Pg 29	19.0	23.0	23.0	27.5	41	36	13	25



1
2
3
4
5
6
7
8
9
10
11
12

8

Kabelverschraubungen Progress® Kunststoff GFK für mehrere Kabel

Synthetic cable glands Progress® GFK for installation of multiple cables

Anschlussgewinde metrisch | Entry thread metric

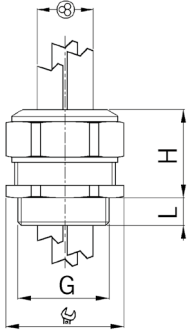

Material: Polyamid glasfaserverstärkt
 Eigenschaften: halogenfrei
 Dichtung: TPE
 Zugentlastung: Ausführung A nach EN 62444
 Einsatztemperatur: -20°C / +100°C
 Schutzart: IP 68

Material: Polyamide glass fiber reinforced
 Properties: halogen-free
 Seal: TPE
 Strain relief: Version A acc. to EN 62444
 Temperature range: -20°C / +100°C
 Protection class: IP 68



Progress GFK Multi

Hellgrau RAL 7035
 Einteiliger Dichteinsatz

Light grey RAL 7035
 One-piece sealing insert

G	> Ø < min mm	> Ø < max mm	⊗	⊗ mm	H mm	L mm	Art.-Nr. Art. No.	📦
M16x1.5	2.0	3.0	2	21	26	12	1571.17.2.030	50
M16x1.5	2.5	4.0	2	21	26	12	1571.17.2.040	50
M16x1.5	3.5	5.0	2	21	26	12	1571.17.2.050	50
M20x1.5	3.5	5.0	2	27	28	13	1571.20.2.050	50
M20x1.5	4.5	6.0	2	27	28	13	1571.20.2.060	50
M20x1.5	5.5	7.5	2	27	28	13	1571.20.2.075	50
M20x1.5	3.5	5.0	3	27	28	13	1571.20.3.050	50
M20x1.5	4.5	6.0	3	27	28	13	1571.20.3.060	50
M20x1.5	5.2	6.5	3	27	28	13	1571.20.3.065	50
M20x1.5	3.5	5.0	4	27	28	13	1571.20.4.050	50
M20x1.5	4.5	6.0	4	27	28	13	1571.20.4.060	50
M25x1.5	5.0	7.0	2	34	33	13	1571.25.2.070	25
M25x1.5	6.7	9.0	2	34	33	13	1571.25.2.090	25
M25x1.5	7.7	10.0	2	34	33	13	1571.25.2.100	25
M25x1.5	5.5	7.0	3	34	33	13	1571.25.3.070	25
M25x1.5	6.8	9.0	3	34	33	13	1571.25.3.090	25
M25x1.5	5.5	7.0	4	34	33	13	1571.25.4.070	25
M25x1.5	4.8	6.0	6	34	33	13	1571.25.6.060	25
M32x1.5	9.0	11.5	2	41	35	15	1571.32.2.115	25
M32x1.5	7.0	9.0	3	41	35	15	1571.32.3.090	25
M32x1.5	8.5	10.5	3	41	35	15	1571.32.3.105	25
M32x1.5	7.0	9.0	4	41	35	15	1571.32.4.090	25
M32x1.5	5.8	7.0	6	41	35	15	1571.32.6.070	25

Weitere Ausführungen und Farben auf Anfrage: z.B. dunkelgrau RAL 7001, schwarz RAL 9005, grössere Anschlussgewinde

Additional versions and colours are available upon request: e.g. dark grey RAL 7001, black RAL 9005, larger entry threads

Kabelverschraubungen Progress® Kunststoff GFK für mehrere Kabel Synthetic cable glands Progress® GFK for installation of multiple cables

Anschlussgewinde Pg | Entry thread Pg

Material: Polyamid glasfaserverstärkt
Eigenschaften: halogenfrei
Dichtung: TPE
Einsatztemperatur: -20°C / +100°C
Schutzart: IP 68

Material: Polyamide glass fiber reinforced
Properties: halogen-free
Seal: TPE
Temperature range: -20°C / +100°C
Protection class: IP 68

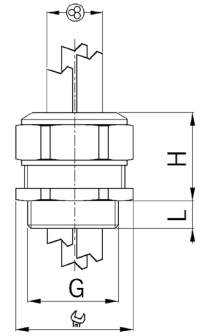

Progress GFK Multi



Hellgrau RAL 7035 Einteiliger Dichteinsatz							Light grey RAL 7035 One-piece sealing insert		
G	>Ø< min mm	>Ø< max mm	⊗	⊗ mm	H mm	L mm	Art.-Nr. Art. No.		
Pg 9	2.0	3.0	2	21	26	12	1571.09.2.030	50	
Pg 9	2.5	4.0	2	21	26	12	1571.09.2.040	50	
Pg 9	3.5	5.0	2	21	26	12	1571.09.2.050	50	
Pg 11	3.5	5.0	2	24	28	12	1571.11.2.050	50	
Pg 11	4.5	6.0	2	24	28	12	1571.11.2.060	50	
Pg 11	3.5	5.0	3	24	28	12	1571.11.3.050	50	
Pg 13	3.5	5.0	2	27	28	13	1571.13.2.050	50	
Pg 13	4.5	6.0	2	27	28	13	1571.13.2.060	50	
Pg 13	5.5	7.5	2	27	28	13	1571.13.2.075	50	
Pg 13	3.5	5.0	3	27	28	13	1571.13.3.050	50	
Pg 13	4.5	6.0	3	27	28	13	1571.13.3.060	50	
Pg 13	5.2	6.5	3	27	28	13	1571.13.3.065	50	
Pg 13	3.5	5.0	4	27	28	13	1571.13.4.050	50	
Pg 13	4.5	6.0	4	27	28	13	1571.13.4.060	50	
Pg 16	3.5	5.0	2	27	28	13	1571.16.2.050	50	
Pg 16	4.5	6.0	2	27	28	13	1571.16.2.060	50	
Pg 16	5.5	7.5	2	27	28	13	1571.16.2.075	50	
Pg 16	3.5	5.0	3	27	28	13	1571.16.3.050	50	
Pg 16	4.5	6.0	3	27	28	13	1571.16.3.060	50	
Pg 16	5.2	6.5	3	27	28	13	1571.16.3.065	50	
Pg 16	3.5	5.0	4	27	28	13	1571.16.4.050	50	
Pg 16	4.5	6.0	4	27	28	13	1571.16.4.060	50	
Pg 21	5.0	7.0	2	34	33	13	1571.21.2.070	25	
Pg 21	6.7	9.0	2	34	33	13	1571.21.2.090	25	
Pg 21	7.7	10.0	2	34	33	13	1571.21.2.100	25	
Pg 21	5.5	7.0	3	34	33	13	1571.21.3.070	25	
Pg 21	6.8	9.0	3	34	33	13	1571.21.3.090	25	
Pg 21	5.5	7.0	4	34	33	13	1571.21.4.070	25	
Pg 21	4.8	6.0	6	34	33	13	1571.21.6.060	25	
Pg 29	7.5	9.0	3	41	36	13	1571.29.3.090	25	



Weitere Ausführungen und Farben auf Anfrage: z.B. dunkelgrau RAL 7001, schwarz RAL 9005, grössere Anschlussgewinde

Additional versions and colours are available upon request: e.g. dark grey RAL 7001, black RAL 9005, larger entry threads

Kabelverschraubungen Syntec® Messing und Kunststoff

Cable glands Syntec® nickel-plated brass and synthetics

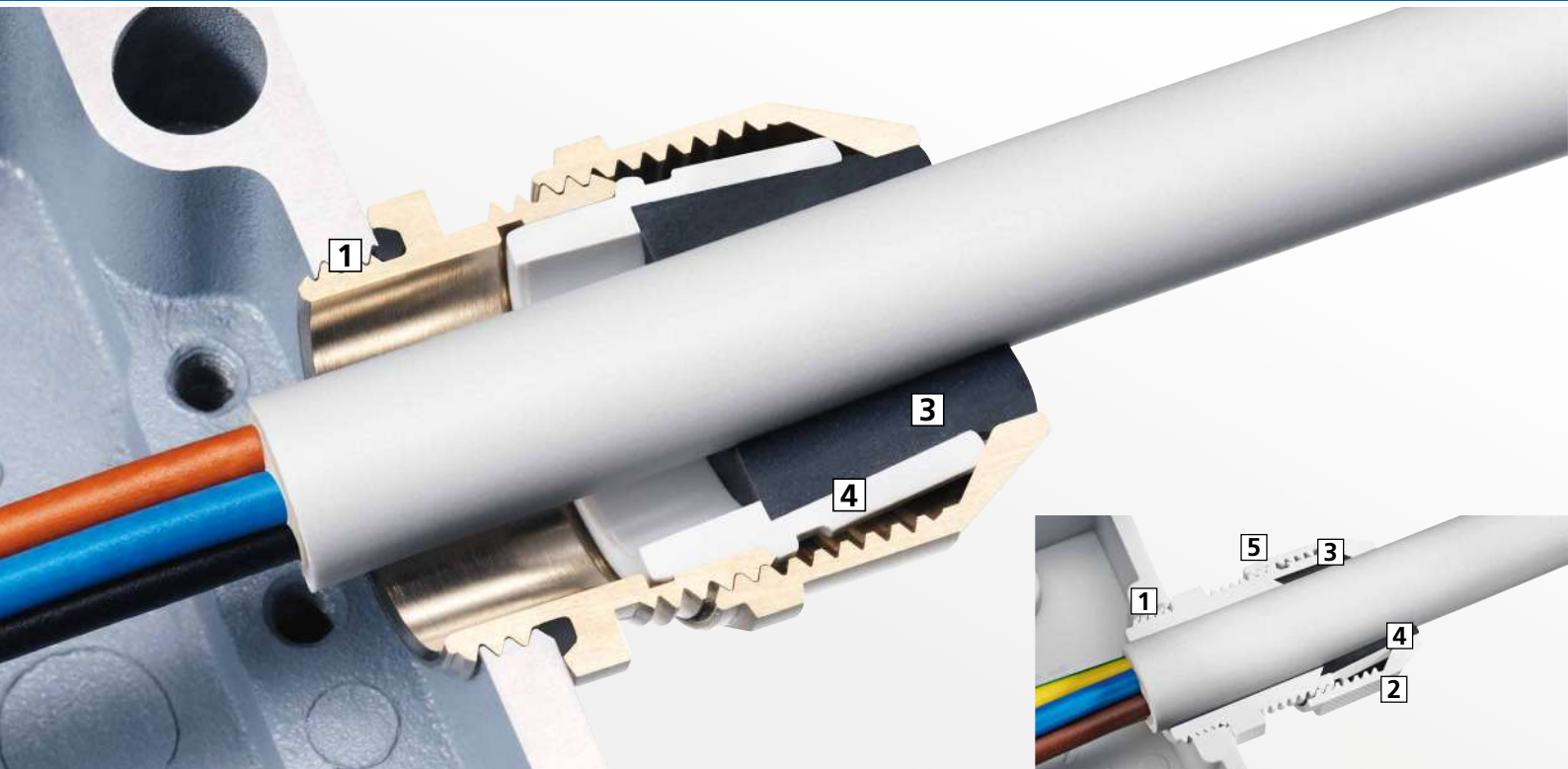

Kabelverschraubungen Syntec® Messing und Kunststoff mit innovativer Lamellentechnik. Die beweglichen Gelenklamellen ermöglichen grosse Klemm- und Dichtbereiche für den flexiblen Einsatz und sicheren täglichen Einsatz. Die Vorfixierung der Kunststoff Druckmutter erleichtert Überkopf-Montagen sehr.

1 Kurzes oder langes Gewinde

Qualitätsverschraubungen mit kurzem oder langem metrischen Gewinde für die sichere Befestigung mit Gewinde oder Gegenmutter.

2 Hörbare Sicherheit in Kunststoff

Die Rastnocken der Druckmutter garantieren mit hörbarem „Klick“ immer den vibrations- und rüttelfesten Halt des Kabels.

3 Garantierte Dichtigkeit

Die elastischen, umweltbeständigen Dichtringe halten sicher dicht, sind besonders langlebig und garantieren die Schutzart IP 68.

4 Einzigartige Lamellentechnik

Die von AGRO entwickelte Lamellengeometrie mit beweglichen Gelenklamellen ermöglicht das Einführen verschiedener Durchmesser in die Syntec® Kabelverschraubung bei hervorragender Zugentlastung und exzellentem Verdrehschutz.

5 Grosse Schlüsselflächen in Kunststoff

Der grossflächige Sechskant der Druckmutter bietet immer sicheren und festen Halt beim Festziehen von Hand oder mit dem Werkzeug.

AGRO Cable glands Syntec® nickel-plated brass and synthetic material with innovative lamellar technology. The movable articulated lamellas provide large clamping and sealing areas for secure and flexible everyday use. The pre-fixation of the synthetic compression nut allows for overhead installation.

1 Short or long thread

Quality cable glands with a short or long metrical thread for secure fastening with thread or counter nut.

2 Audible reliability in synthetic material

The snap-in pins of the compression nuts give an audible “click” that guarantees vibration- and shake-proof hold.

3 Guaranteed tightness

The elastic sealing rings provide a reliable seal, are particularly durable and offer guaranteed protection to protection class IP 68.

4 Unique lamellar technology

The AGRO-developed lamellar geometry with movable jointed lamellar support the insertion of varying diameters into the Syntec® cable gland and ensure outstanding strain relief and distortion protection.

5 Large spanner flats in synthetic material

The large hexagonal element of the screw-down nuts ensures consistently reliable and secure hold when turning by hand and tightening with the tool.

Trapezförmige Gelenklamellen

Trapezoidal lamellas



Die einzigartige Lamellentechnik garantiert eine hervorragende Zugentlastung.



Die trapezförmigen Lamellen gleiten beim Anziehen der Kabelverschraubung ineinander und verpressen das Kabel verdrehsicher in ein Sechseck.

The unique lamellar technology guarantees an excellent strain relief.

When tightening the compression nut of the cable gland, the single lamellas slide into a hexagon and thus compress the cable in a torsion proof way.





Kabelverschraubungen Syntec® Messing mit Lamellentechnik Cable glands Syntec® nickel-plated brass with lamellar technology		186
Kabelverschraubungen Syntec® Kunststoff mit Lamellentechnik Synthetic cable glands Syntec® with lamellar technology		187 - 190
Kabelverschraubungen Syntec® Kunststoff mit Lamellentechnik und Knickschutz Synthetic Syntec® cable glands with lamellar technology and antikink nozzle		191 - 193

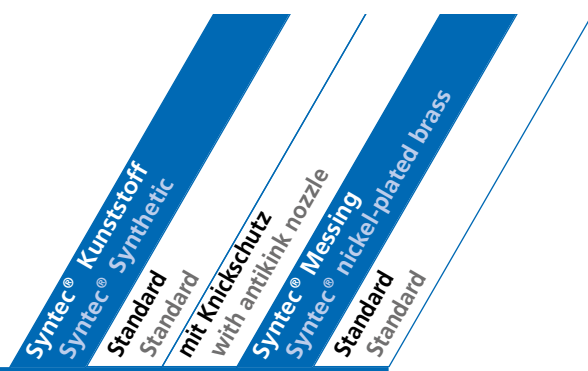

Ausführung / Version	Syntec® Kunststoff / Synthetic Standard	mit Knickschutz / with antikink nozzle	Syntec® Messing / Syntec® nickel-plated brass Standard
Lamellentechnik Lamellar technology	•	•	•
Gewinde / Thread			
Anschlussgewinde Pg Entry thread Pg	•	•	A
Anschlussgewinde NPT Entry thread NPT	•	•	-
Kurzes Anschlussgewinde metrisch Short entry thread metric	•	•	•
Langes Anschlussgewinde metrisch Long entry thread metric	•	•	•
Dichteinsatz / Sealing insert			
für Rundkabel for round cables	•	•	•
Standard Dichtring (TPE/CR) Standard sealing ring (TPE/CR)	•	•	•
Technische Besonderheiten / Technical features			
erhöhter Vibrationsschutz Increased Vibration resistance	•	•	-
Knickschutz Antikink coil	-	•	-
Farben / Colours			
Hellgrau RAL 7035 Light grey RL 7035	•	•	-
Dunkelgrau RAL 7001 Dark grey RAL 7001	A	A	-
Schwarz RAL 9005 Black RAL 9005	•	•	-
Messing vernickelt Nickel-plated brass	-	-	•
A = auf Anfrage / upon request			

1
2
3
4
5
6
7
8
9
10
11
12

Kabelverschraubungen Syntec® Messing mit Lamellentechnik

Cable glands Syntec® nickel-plated brass with lamellar technology

Kurzes Anschlussgewinde metrisch | Short entry thread metric

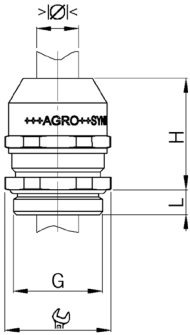

Material: Messing vernickelt
 Dichtring: TPE
 O-Ring: NBR
 Lamelleneinsatz: Polyamid PA 6
 Zugentlastung: Ausführung A nach EN 62444
 Einsatztemperatur: -40°C / +100°C
 Schutzart: IP 68

Material: Nickel-plated brass
 Sealing ring: TPE
 O-ring: NBR
 Lamellar insert: Polyamide PA 6
 Strain relief: Version A acc. to EN 62444
 Temperature range: -40°C / +100°C
 Protection class: IP 68



SYNTEC MS



Einteiliger Dichtring
 nicht durchgehend isolierend

One-piece sealing ring
 not overall length insulated

G	>Ø< min mm	>Ø< max mm	Ø mm	H mm	L mm	Art.-Nr. Art. No.	
M12x1.5	1.0	5.0	15	17	5	1045.12.050	50
M12x1.5	3.0	7.0	15	17	5	1045.12.070	50
M16x1.5	2.0	6.0	18	20	5	1045.17.060	50
M16x1.5	4.5	10.0	18	20	5	1045.17.100	50
M20x1.5	3.5	8.0	22	25	6	1045.20.080	50
M20x1.5	7.0	13.0	22	25	6	1045.20.130	50
M25x1.5	5.0	11.0	28	31	7	1045.25.110	25
M25x1.5	10.0	17.0	28	31	7	1045.25.170	25
M32x1.5	7.0	15.0	36	33	8	1045.32.150	25
M32x1.5	13.0	21.0	36	33	8	1045.32.210	25
M40x1.5	15.0	23.0	46	40	8	1045.40.230	10
M40x1.5	19.0	28.0	46	40	8	1045.40.280	10
M50x1.5	20.0	29.0	55	40	9	1045.50.290	5
M50x1.5	25.0	35.0	55	40	9	1045.50.350	5
M63x1.5	28.0	39.0	70	43	10	1045.63.390	5
M63x1.5	35.0	48.0	70	43	10	1045.63.480	5

Auf Anfrage lieferbar:

Available on request

Syntec® Messing mit Pg Anschlussgewinde

Syntec® Messing mit Pg Anschlussgewinde

Langes Anschlussgewinde metrisch | Long entry thread metric



SYNTEC MS



Einteiliger Dichtring
 nicht durchgehend isolierend

One-piece sealing ring
 not overall length insulated

G	>Ø< min mm	>Ø< max mm	Ø mm	H mm	L mm	Art.-Nr. Art. No.	
M12x1.5	1.0	5.0	15	17	12	1145.12.050	50
M12x1.5	3.0	7.0	15	17	12	1145.12.070	50
M16x1.5	2.0	6.0	18	20	12	1145.17.060	50
M16x1.5	4.5	10.0	18	20	12	1145.17.100	50
M20x1.5	3.5	8.0	22	25	12	1145.20.080	50
M20x1.5	7.0	13.0	22	25	12	1145.20.130	50
M25x1.5	5.0	11.0	28	31	12	1145.25.110	25
M25x1.5	10.0	17.0	28	31	12	1145.25.170	25
M32x1.5	7.0	15.0	36	33	15	1145.32.150	25
M32x1.5	13.0	21.0	36	33	15	1145.32.210	25
M40x1.5	15.0	23.0	46	40	15	1145.40.230	10
M40x1.5	19.0	28.0	46	40	15	1145.40.280	10
M50x1.5	20.0	29.0	55	40	15	1145.50.290	5
M50x1.5	25.0	35.0	55	40	15	1145.50.350	5
M63x1.5	28.0	39.0	70	43	15	1145.63.390	5
M63x1.5	35.0	48.0	70	43	15	1145.63.480	5
M63x1.5	44.0	55.0	80	43	15	1145.63.550	5

Kabelverschraubungen Syntec® Kunststoff mit Lamellentechnik Synthetic cable glands Syntec® with lamellar technology

Kurzes Anschlussgewinde metrisch | Short entry thread metric

Material: Polyamid PA 6
Eigenschaften: halogenfrei
Dichtring: TPE oder CR (Neopren)
Zugentlastung: Ausführung A nach EN 62444
Einsatztemperatur: -30°C / +100°C
Schutzart: IP 68

Material: Polyamide PA 6
Properties: halogen-free
Sealing ring: TPE or CR (Neoprene)
Strain relief: Version A acc. to EN 62444
Temperature range: -30°C / +100°C
Protection class: IP 68

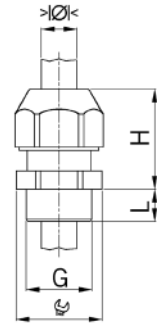

SYNTEC



Hellgrau RAL 7035
Einteiliger Dichtring

Light grey RAL 7035
One-piece sealing ring

G	> Ø < min mm	> Ø < max mm	Ø mm	H mm	L mm	Art.-Nr. No art.	
M12x1.5	2.5	6.5	15	21	6	1555.12.06	100
M16x1.5	2.0	6.0	19	25	8	1555.17.06	50
M16x1.5	5.0	10.0	19	25	8	1555.17.10	50
M20x1.5	3.5	8.0	24	29	9	1555.20.08	50
M20x1.5	7.0	13.0	24	29	9	1555.20.13	50
M25x1.5	5.0	11.0	29	38	10	1555.25.11	25
M25x1.5	10.0	17.0	29	38	10	1555.25.17	25
M32x1.5	17.0	25.0	42	36	10	1555.32.25	20

Auf Anfrage lieferbar:

Available on request

Ausführung in dunkelgrau RAL 7001

Version in dark grey RAL 7001



SYNTEC



Schwarz RAL 9005
Einteiliger Dichtring

Black RAL 9005
One-piece sealing ring

G	> Ø < min mm	> Ø < max mm	Ø mm	H mm	L mm	Art.-Nr. No art.	
M12x1.5	2.5	6.5	15	21	6	1545.12.06	100
M16x1.5	2.0	6.0	19	25	8	1545.17.06	50
M16x1.5	5.0	10.0	19	25	8	1545.17.10	50
M20x1.5	3.5	8.0	24	29	9	1545.20.08	50
M20x1.5	7.0	13.0	24	29	9	1545.20.13	50
M25x1.5	5.0	11.0	29	38	10	1545.25.11	25
M25x1.5	10.0	17.0	29	38	10	1545.25.17	25
M32x1.5	17.0	25.0	42	36	10	1545.32.25	20



Kabelverschraubungen Syntec® Kunststoff mit Lamellentechneik

Synthetic cable glands Syntec® with lamellar technology

Langes Anschlussgewinde metrisch | Long entry thread metric

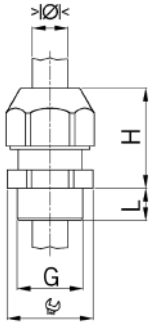

Material: Polyamid PA 6
 Eigenschaften: halogenfrei
 Dichtring: TPE oder CR (Neopren)
 Zugentlastung: Ausführung A nach EN 62444
 Einsatztemperatur: -30°C / +100°C
 Schutzart: IP 68

Material: Polyamide PA 6
 Properties: halogen-free
 Sealing ring: TPE or CR (Neoprene)
 Strain relief: Version A acc. to EN 62444
 Temperature range: -30°C / +100°C
 Protection class: IP 68



SYNTEC

Hellgrau RAL 7035
 Einteiliger Dichtring

Light grey RAL 7035
 One-piece sealing ring



G	>Ø< min mm	>Ø< max mm	Ø mm	H mm	L mm	Art.-Nr. Art. No.	
M12x1.5	2.5	6.5	15	21	12	1555.12.1.06	100
M16x1.5	2.0	6.0	19	25	15	1555.17.1.06	50
M16x1.5	5.0	10.0	19	25	15	1555.17.1.10	50
M20x1.5	3.5	8.0	24	29	15	1555.20.1.08	50
M20x1.5	7.0	13.0	24	29	15	1555.20.1.13	50
M25x1.5	5.0	11.0	29	38	15	1555.25.1.11	25
M25x1.5	10.0	17.0	29	38	15	1555.25.1.17	25
M32x1.5	17.0	25.0	42	36	15	1555.32.1.25	20
M40x1.5	22.0	33.0	53	48	15	1555.40.1.33	10
M50x1.5	28.0	38.0	60	48	15	1555.50.1.38	5
M63x1.5	32.0	44.0	65	49	16	1555.63.1.44	5

Auf Anfrage lieferbar:

Available on request

Ausführung in dunkelgrau RAL 7001

Version in dark grey RAL 7001

SYNTEC

Schwarz RAL 9005
 Einteiliger Dichtring

Black RAL 9005
 One-piece sealing ring



G	>Ø< min mm	>Ø< max mm	Ø mm	H mm	L mm	Art.-Nr. Art. No.	
M12x1.5	2.5	6.5	15	21	12	1545.12.1.06	100
M16x1.5	2.0	6.0	19	25	15	1545.17.1.06	50
M16x1.5	5.0	10.0	19	25	15	1545.17.1.10	50
M20x1.5	3.5	8.0	24	29	15	1545.20.1.08	50
M20x1.5	7.0	13.0	24	29	15	1545.20.1.13	50
M25x1.5	5.0	11.0	29	38	15	1545.25.1.11	25
M25x1.5	10.0	17.0	29	38	15	1545.25.1.17	25
M32x1.5	17.0	25.0	42	36	15	1545.32.1.25	20
M40x1.5	22.0	33.0	53	48	15	1545.40.1.33	10
M50x1.5	28.0	38.0	60	48	15	1545.50.1.38	5
M63x1.5	32.0	44.0	65	49	16	1545.63.1.44	5

Kabelverschraubungen Syntec® Kunststoff mit Lamellentechneik

Synthetic cable glands Syntec® with lamellar technology

Anschlussgewinde Pg | Entry thread Pg

Material: Polyamid PA 6
 Eigenschaften: halogenfrei
 Dichtring: CR (Neopren)
 Einsatztemperatur: -30°C / +100°C
 Schutzart: IP 68

Material: Polyamide PA 6
 Properties: halogen-free
 Sealing ring: CR (neoprene)
 Temperature range: -30°C / +100°C
 Protection class: IP 68

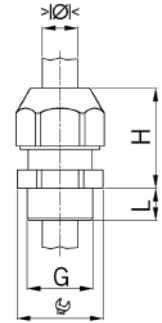

SYNTEC



Hellgrau RAL 7035
 Einteiliger Dichtring

Light grey RAL 7035
 One-piece sealing ring

G	>Ø< min mm	>Ø< max mm	Ø mm	H mm	L mm	Art.-Nr. Art. No.	
Pg 7	2.5	6.5	15	21	8	1555.07.06	100
Pg 9	3.0	8.0	19	23	8	1555.09.08	50
Pg 11	2.0	7.0	22	25	8	1555.11.07	50
Pg 11	4.0	10.0	22	25	8	1555.11.10	50
Pg 13	3.0	7.0	24	26	9	1555.13.07	50
Pg 13	5.5	12.0	24	26	9	1555.13.12	50
Pg 16	5.0	11.0	27	30	10	1555.16.11	50
Pg 16	8.5	14.0	27	30	10	1555.16.14	50
Pg 21	6.5	14.0	33	35	11	1555.21.14	25
Pg 21	11.0	18.0	33	35	11	1555.21.18	25
Pg 29	17.0	25.0	42	36	11	1555.29.25	20
Pg 36	22.0	33.0	53	48	15	1555.36.33	10
Pg 42	28.0	38.0	60	48	15	1555.42.38	5
Pg 48	32.0	44.0	65	48	15	1555.48.44	5

Auf Anfrage lieferbar:

Available on request

Ausführung in dunkelgrau RAL 7001

Version in dark grey RAL 7001



SYNTEC



Schwarz RAL 9005
 Einteiliger Dichtring

Black RAL 9005
 One-piece sealing ring

G	>Ø< min mm	>Ø< max mm	Ø mm	H mm	L mm	Art.-Nr. Art. No.	
Pg 7	2.5	6.5	15	21	8	1545.07.06	100
Pg 9	3.0	8.0	19	23	8	1545.09.08	50
Pg 11	2.0	7.0	22	25	8	1545.11.07	50
Pg 11	4.0	10.0	22	25	8	1545.11.10	50
Pg 13	3.0	7.0	24	26	9	1545.13.07	50
Pg 13	5.5	12.0	24	26	9	1545.13.12	50
Pg 16	5.0	11.0	27	30	10	1545.16.11	50
Pg 16	8.5	14.0	27	30	10	1545.16.14	50
Pg 21	6.5	14.0	33	35	11	1545.21.14	25
Pg 21	11.0	18.0	33	35	11	1545.21.18	25
Pg 29	17.0	25.0	42	36	11	1545.29.25	20
Pg 36	22.0	33.0	53	48	15	1545.36.33	10
Pg 42	28.0	38.0	60	48	15	1545.42.38	5
Pg 48	32.0	44.0	65	48	15	1545.48.44	5



Kabelverschraubungen Syntec® Kunststoff mit Lamellentechneik

Synthetic cable glands Syntec® with lamellar technology

Anschlussgewinde NPT | Entry thread NPT

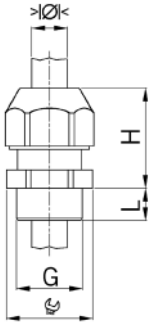

Material: Polyamid PA 6
 Eigenschaften: halogenfrei
 Dichtring: CR (Neopren)
 Einsatztemperatur: -30°C / +100°C
 Schutzart: IP 54
 Weitere Schutzart: IP 68, wenn Anschlussgewinde abgedichtet

Material: Polyamide PA 6
 Properties: halogen-free
 Sealing ring: CR (neoprene)
 Temperature range: -30°C / +100°C
 Protection class: IP 54
 Further protection: IP 68, if the entry thread is sealed



SYNTEC



Hellgrau RAL 7035
 Einteiliger Dichtring

Light grey RAL 7035
 One-piece sealing ring

G	> Ø < min mm	> Ø < max mm	mm	H mm	L mm	Art.-Nr. Art. No.	
NPT 3/8"	3.0	8.0	19/22	23	15	1555.N0375.08	50
NPT 1/2"	3.0	7.0	24	26	15	1555.N0500.07	50
NPT 1/2"	5.5	12.0	24	26	15	1555.N0500.12	50
NPT 3/4"	6.5	14.0	33	35	15	1555.N0750.14	25
NPT 3/4"	11.0	18.0	33	35	15	1555.N0750.18	25
NPT 1"	17.0	22.0	42	36	15	1555.N1000.22	20

Auf Anfrage lieferbar:

Available on request

Ausführung in dunkelgrau RAL 7001

Version in dark grey RAL 7001



SYNTEC



Schwarz RAL 9005
 Einteiliger Dichtring

Black RAL 9005
 One-piece sealing ring

G	> Ø < min mm	> Ø < max mm	mm	H mm	L mm	Art.-Nr. Art. No.	
NPT 3/8"	3.0	8.0	19/22	23	15	1545.N0375.08	50
NPT 1/2"	3.0	7.0	24	26	15	1545.N0500.07	50
NPT 1/2"	5.5	12.0	24	26	15	1545.N0500.12	50
NPT 3/4"	6.5	14.0	33	35	15	1545.N0750.14	25
NPT 3/4"	11.0	18.0	33	35	15	1545.N0750.18	25
NPT 1"	17.0	22.0	42	36	15	1545.N1000.22	20

Kabelverschraubungen Syntec® Kunststoff mit Lamellentechnik und Knickschutz

Synthetic Syntec® cable glands with lamellar technology and anti-kink nozzle

Kurzes Anschlussgewinde metrisch | Short entry thread metric

Material: Polyamid PA 6
 Eigenschaften: halogenfrei
 Dichtring: CR (Neopren)
 Zugentlastung: Ausführung A nach EN 62444
 Einsatztemperatur: -30°C / +100°C
 Schutzart: IP 68

Material: Polyamide PA 6
 Properties: halogen-free
 Sealing ring: CR (neoprene)
 Strain relief: Version A acc. to EN 62444
 Temperature range: -30°C / +100°C
 Protection class: IP 68

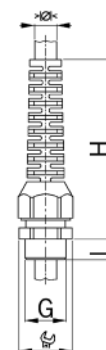

SYNTEC mit Knickschutz



Hellgrau RAL 7035
 Einteiliger Dichtring

Light grey RAL 7035
 One-piece sealing ring

G	> Ø < min mm	> Ø < max mm	mm	H mm	L mm	Art.-Nr. Art. No.	
M12x1.5	2.5	6.5	15	54	6	1576.12.06	50
M16x1.5	4.0	8.0	19	64	6	1576.17.08	50
M20x1.5	3.0	7.0	24	88	8	1576.20.07	50
M20x1.5	5.5	12.0	24	88	8	1576.20.12	50

Auf Anfrage lieferbar:
 Ausführung in dunkelgrau RAL 7001

Available on request
 Version in dark grey RAL 7001



SYNTEC mit Knickschutz



Schwarz RAL 9005
 Einteiliger Dichtring

Black RAL 9005
 One-piece sealing ring

G	> Ø < min mm	> Ø < max mm	mm	H mm	L mm	Art.-Nr. Art. No.	
M12x1.5	2.5	6.5	15	54	6	1546.12.06	50
M16x1.5	4.0	8.0	19	64	6	1546.17.08	50
M20x1.5	3.0	7.0	24	88	8	1546.20.07	50
M20x1.5	5.5	12.0	24	88	8	1546.20.12	50



Langes Anschlussgewinde metrisch | Long entry thread metric

SYNTEC mit Knickschutz



Hellgrau RAL 7035
 Einteiliger Dichtring

Light grey RAL 7035
 One-piece sealing ring

G	> Ø < min mm	> Ø < max mm	mm	H mm	L mm	Art.-Nr. Art. No.	
M12x1.5	2.5	6.5	15	54	12	1576.12.1.06	50
M16x1.5	4.0	8.0	19	64	12	1576.17.1.08	50
M20x1.5	3.0	7.0	24	88	13	1576.20.1.07	50
M20x1.5	5.5	12.0	24	88	13	1576.20.1.12	50

Auf Anfrage lieferbar:
 Ausführung in dunkelgrau RAL 7001

Available on request
 Version in dark grey RAL 7001



SYNTEC mit Knickschutz



Schwarz RAL 9005
 Einteiliger Dichtring

Black RAL 9005
 One-piece sealing ring

G	> Ø < min mm	> Ø < max mm	mm	H mm	L mm	Art.-Nr. Art. No.	
M12x1.5	2.5	6.5	15	54	12	1546.12.1.06	50
M16x1.5	4.0	8.0	19	64	12	1546.17.1.08	50
M20x1.5	3.0	7.0	24	88	13	1546.20.1.07	50
M20x1.5	5.5	12.0	24	88	13	1546.20.1.12	50



Kabelverschraubungen Syntec® Kunststoff mit Lamellentechnik und Knickschutz Synthetic Syntec® cable glands with lamellar technology and anti-kink nozzle

Anschlussgewinde Pg | Entry thread Pg

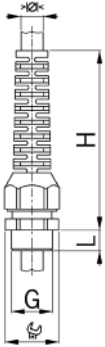

Material: Polyamid PA 6
Eigenschaften: halogenfrei
Dichtring: CR (Neopren)
Einsatztemperatur: -30°C / +100°C
Schutzart: IP 68

Material: Polyamide PA 6
Properties: halogen-free
Sealing ring: CR (neoprene)
Temperature range: -30°C / +100°C
Protection class: IP 68



SYNTEC mit Knickschutz



Hellgrau RAL 7035
Einteiliger Dichtring

Light grey RAL 7035
One-piece sealing ring

G	>Ø< min mm	>Ø< max mm	mm	H mm	L mm	Art.-Nr. Art. No.	
Pg 7	2.5	6.5	15	54	8	1576.07.06	50
Pg 9	3.0	8.0	19	64	8	1576.09.08	50
Pg 11	2.0	7.0	22	77	8	1576.11.07	50
Pg 11	4.0	10.0	22	77	8	1576.11.10	50
Pg 13	3.0	7.0	24	88	9	1576.13.07	50
Pg 13	5.5	12.0	24	88	9	1576.13.12	50
Pg 16	5.0	11.0	27	102	10	1576.16.11	50
Pg 16	8.5	14.0	27	102	10	1576.16.14	50

Auf Anfrage lieferbar:
Ausführung in dunkelgrau RAL 7001

Available on request
Version in dark grey RAL 7001



SYNTEC mit Knickschutz



Schwarz RAL 9005
Einteiliger Dichtring

Black RAL 9005
One-piece sealing ring

G	>Ø< min mm	>Ø< max mm	mm	H mm	L mm	Art.-Nr. Art. No.	
Pg 7	2.5	6.5	15	54	8	1546.07.06	50
Pg 9	3.0	8.0	19	64	8	1546.09.08	50
Pg 11	2.0	7.0	22	77	8	1546.11.07	50
Pg 11	4.0	10.0	22	77	8	1546.11.10	50
Pg 13	3.0	7.0	24	88	9	1546.13.07	50
Pg 13	5.5	12.0	24	88	9	1546.13.12	50
Pg 16	5.0	11.0	27	102	10	1546.16.11	50
Pg 16	8.5	14.0	27	102	10	1546.16.14	50

Kabelverschraubungen Syntec® Kunststoff mit Lamellentechnik und Knickschutz

Synthetic Syntec® cable glands with lamellar technology and anti-kink nozzle

Anschlussgewinde NPT | Entry thread NPT

Material: Polyamid PA 6
 Eigenschaften: halogenfrei
 Dichtring: CR (Neopren)
 Einsatztemperatur: -30°C / +100°C
 Schutzart: IP 54
 Weitere Schutzart: IP 68, wenn Anschlussgewinde abgedichtet

Material: Polyamide PA 6
 Properties: halogen-free
 Sealing ring: CR (neoprene)
 Temperature range: -30°C / +100°C
 Protection class: IP 54
 Further protection: IP 68, if the entry thread is sealed

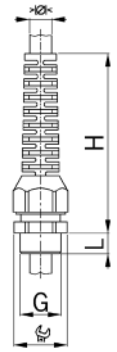

SYNTEC mit Knickschutz



Hellgrau RAL 7035		Light grey RAL 7035					
Einteiliger Dichtring		One-piece sealing ring					
G	> Ø < min mm	> Ø < max mm	mm	H mm	L mm	Art.-Nr. Art. No.	
NPT 3/8"	3.0	8.0	19/22	64	15	1576.N0375.08	50
NPT 1/2"	3.0	7.0	24	88	15	1576.N0500.07	50
NPT 1/2"	5.5	12.0	24	88	15	1576.N0500.12	50

Auf Anfrage lieferbar: Available on request
 Ausführung in dunkelgrau RAL 7001 Version in dark grey RAL 7001



SYNTEC mit Knickschutz



Schwarz RAL 9005		Black RAL 9005					
Einteiliger Dichtring		One-piece sealing ring					
G	> Ø < min mm	> Ø < max mm	mm	H mm	L mm	Art.-Nr. Art. No.	
NPT 3/8"	3.0	8.0	19/22	64	15	1546.N0375.08	50
NPT 1/2"	3.0	7.0	24	88	15	1546.N0500.07	50
NPT 1/2"	5.5	12.0	24	88	15	1546.N0500.12	50



Flanschwinkel und Winkel

Flanged elbows and elbows



Sind bei der Kabelinstallation enge Raumverhältnisse gegeben, kann der Anwender auf die Vorteile von **Winkeln und Flanschwinkeln** bauen. Hier werden Leitungen um die Ecke geführt und je nach der verwendeten Kabelverschraubung zu 100% vor der Knickstelle zugentlastet. Bei den Kunststoff-Flanschwinkeln erleichtert zudem ein spezieller Klappmechanismus die Kabelinstallation.

Die Quickseal Kabeleinführungstüllen sind spezielle Durchführungsmembranen und können auch als Verschlussstopfen verwendet werden. Zur Montage wird kein Werkzeug benötigt. Einfach Kabeldurchführung einstecken. Danach wird die geschlossene Membran durch Einstecken des durchzuführenden Kabels durchstossen.

Die Würgenippel aus Kunststoff sind für den Einsatz in Installationsbereichen ohne besonderen Einsatz bestens geeignet. Erhältlich mit und ohne Bohrung.

If space is limited, the user can take advantage of the benefits of **elbows and flanged elbows** for cable installations.

The cables are run around the bend and, depending upon the type of cable gland used, completely relieved of any strain before the kinking point.

A special folding mechanism simplifies the cable installation for synthetic flanged elbows.

Quickseal cable grommets are unique feedthrough membranes which can also be used as sealing caps. No tools are needed for assembly – simply insert the cable grommet. Afterwards, you take the cable to be fed through and push it through the closed membrane.

These locking plugs made of plastic are especially well suited for use in electrical installations and require no special effort to use. Available with and without pre-drilled holes.



Winkel-Kabelverschraubungen 90° Kunststoff Synthetic cable glands elbow 90°		196
Flanschwinkel 90° Kunststoff Synthetic flanged elbow 90°		197
Quickseal Kabeleinführungstüllen Quickseal cable grommets		198
Würgenippel Kunststoff Synthetic locking plug		199

1

2

3

4

5

6

7

8

9

10

11

12

Winkel-Kabelverschraubungen 90° Kunststoff

Synthetic cable glands elbow 90°

Anschlussgewinde metrisch | Entry thread metric

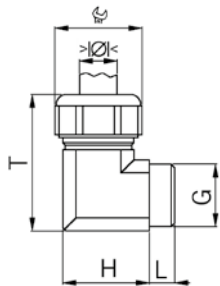

Material: Polyamid PA 6
 Dichtung: TPE
 Einsatztemperatur: -20°C / +100°C
 Schutzart: IP 68

Material: Polyamide PA 6
 Seal: TPE
 Temperature range: -20°C / +100°C
 Protection class: IP 68



Grau RAL 7032

Einteiliger Dichteinsatz

G	$\begin{matrix} > \varnothing < \\ \text{min mm} \end{matrix}$	$\begin{matrix} > \varnothing < \\ \text{max mm} \end{matrix}$	$\begin{matrix} \text{mm} \\ \text{mm} \end{matrix}$	H mm	T mm	L mm
M16x1.5	6.5	9.5	19	23	38	8
M20x1.5	7.0	10.5	24	28	46	9
M20x1.5	9.0	13.0	24	28	46	9
M25x1.5	11.5	15.5	27	32	52	10

Grey RAL 7032

One-piece sealing insert

Art.-Nr. | Art. No.



5215.17.95	25
5215.20.105	25
5215.20.13	25
5215.25.155	25



Schwarz RAL 9005

Einteiliger Dichteinsatz

G	$\begin{matrix} > \varnothing < \\ \text{min mm} \end{matrix}$	$\begin{matrix} > \varnothing < \\ \text{max mm} \end{matrix}$	$\begin{matrix} \text{mm} \\ \text{mm} \end{matrix}$	H mm	T mm	L mm
M16x1.5	6.5	9.5	19	23	38	8
M20x1.5	7.0	10.5	24	28	46	9
M20x1.5	9.0	13.0	24	28	46	9
M25x1.5	11.5	15.5	27	32	52	10

Black RAL 9005

One-piece sealing insert

Art.-Nr. | Art. No.



5215.17.40.95	25
5215.20.40.105	25
5215.20.40.13	25
5215.25.40.155	25

Anschlussgewinde Pg | Entry thread Pg



Grau RAL 7032

Einteiliger Dichteinsatz

G	$\begin{matrix} > \varnothing < \\ \text{min mm} \end{matrix}$	$\begin{matrix} > \varnothing < \\ \text{max mm} \end{matrix}$	$\begin{matrix} \text{mm} \\ \text{mm} \end{matrix}$	H mm	T mm	L mm
Pg 9	4.5	6.5	19	23	38	8
Pg 9	6.5	9.5	19	23	38	8
Pg 11	7.0	10.5	22	25	42	9
Pg 11	4.0	6.5	22	25	42	9
Pg 11	6.5	9.5	22	25	42	9
Pg 13	7.0	10.5	24	28	46	9
Pg 13	9.0	13.0	24	28	46	9
Pg 13	6.5	9.5	24	32	46	9
Pg 16	7.0	10.5	27	32	52	10
Pg 16	9.0	13.0	27	32	52	10
Pg 16	11.5	15.5	27	32	52	10
Pg 16	6.5	9.5	27	32	52	10

Grey RAL 7032

One-piece sealing insert

Art.-Nr. | Art. No.



5215.09.65	25
5215.09.95	25
5215.11.105	25
5215.11.65	25
5215.11.95	25
5215.13.105	25
5215.13.13	25
5215.13.95	25
5215.16.105	25
5215.16.13	25
5215.16.155	25
5215.16.95	25

Flanschwinkel 90° Kunststoff

Synthetic flanged elbow 90°

Anschlussgewinde metrisch | Entry thread metric

Material: Polyamid
 Dichtung: NBR
 Einsatztemperatur: -40°C / +110°C
 Schutzart: IP 65
 Eigenschaften: Der Flanschwinkel lässt sich zum Einführen der Kabel aufklappen und ermöglicht damit eine mühelose Montage

Material: Polyamide
 Seal: NBR
 Temperature range: -40°C / +110°C
 Protection class: IP 65
 Properties: The flanged elbow can be opened to insert the cables and therefore permits an effortless installation

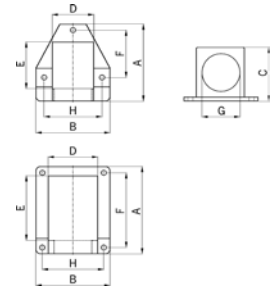

Grau								Grey		
G	A mm	B mm	C mm	D mm	E mm	F mm	H mm		Art.-Nr. Art. No.	
M16x1.5	49	47	35	22	27	29	37	3	5500.20.17	10
M20x1.5	49	47	35	22	27	29	37	3	5500.20.20	10
M25x1.5	69	65	44	30	31	42	52	3	5500.20.25	10
M32x1.5	90	78	55	40	65	65	65	4	5500.20.32	10
M40x1.5	100	94	66	48	68	80	80	4	5500.20.40	5
M50x1.5	116	101	76	63	85	88	88	4	5500.20.50	5



Schwarz								Black		
G	A mm	B mm	C mm	D mm	E mm	F mm	H mm		Art.-Nr. Art. No.	
M16x1.5	49	47	35	22	27	29	37	3	5500.40.17	10
M20x1.5	49	47	35	22	27	29	37	3	5500.40.20	10
M25x1.5	69	65	44	30	31	42	52	3	5500.40.25	10
M32x1.5	90	78	55	40	65	65	65	4	5500.40.32	10
M40x1.5	100	94	66	48	68	80	80	4	5500.40.40	5
M50x1.5	116	101	76	63	85	88	88	4	5500.40.50	5



Anschlussgewinde Pg | Entry thread Pg

Grau								Grey		
G	A mm	B mm	C mm	D mm	E mm	F mm	H mm		Art.-Nr. Art. No.	
Pg 11	49	47	35	22	27	29	37	3	5520.11	10
Pg 16	49	47	35	22	27	29	37	3	5520.16	10
Pg 21	69	65	44	30	31	42	52	3	5520.21	10
Pg 29	90	78	55	40	65	65	65	4	5520.29	10
Pg 36	100	94	66	48	68	80	80	4	5520.36	5
Pg 48	116	101	76	63	85	88	88	4	5520.48.48	5



Schwarz								Black		
G	A mm	B mm	C mm	D mm	E mm	F mm	H mm		Art.-Nr. Art. No.	
Pg 11	49	47	35	22	27	29	37	3	5540.11	10
Pg 16	49	47	35	22	27	29	37	3	5540.16	10
Pg 21	69	65	44	30	31	42	52	3	5540.21	10
Pg 29	90	78	55	40	65	65	65	4	5540.29	10
Pg 36	100	94	66	48	68	80	80	4	5540.36	5
Pg 48	116	101	76	63	85	88	88	4	5540.48.48	5



Quickseal Kabeleinführungstüllen

Quickseal cable grommets

Metrische Nenngrossen | Metric rating

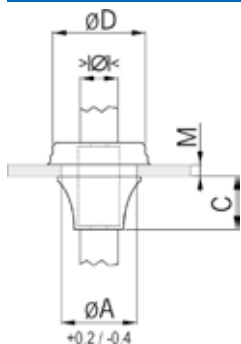

Material: EPDM
 Einsatztemperatur: -40°C / +110°C
 Schutzart: IP 67
 Eigenschaften: Halogenfrei, allseitig IP 67 durch „Pushout-Membrane“, gute Chemikalien- und Witterungsbeständigkeit
 Einsatzbereich: Universell einsetzbar bei Wandstärken von 1 bis 4mm (M16 - M50) bzw. 0.5 bis 2mm (M12)

Material: EPDM
 Temperature range: -40°C / +110°C
 Protection class: IP 67
 Properties: Halogen-free, all-round IP 67 protection thanks to the "pushout-membrane", resistant to chemicals and weatherproof
 Application: Suitable for holes in materials of 1-4mm (M16 - M50), or M12 from 0.5-2mm



Dunkelgrau RAL 7001						Dark grey RAL 7001		
ØA mm	> Ø < min mm	> Ø < max mm	M mm	C mm	ØD mm	Art.-Nr. Art. No.		
12.5	4.0	7.0	0.5-2	5.6	20.0	14.582.33		50
16.5	5.0	9.0	1-4	11.0	21.0	14.582.34		50
20.5	8.0	13.0	1-4	13.4	25.5	14.582.35		50
25.5	11.0	17.0	1-4	15.3	30.5	14.582.36		50
32.5	15.0	20.0	1-4	18.6	38.5	14.582.37		25
40.5	19.0	28.0	1-4	21.7	48.5	14.582.38		25
50.5	27.0	35.0	1-4	25.0	60.5	14.582.39		10



Hellgrau RAL 7035						Light grey RAL 7035		
ØA mm	> Ø < min mm	> Ø < max mm	M mm	C mm	ØD mm	Art.-Nr. Art. No.		
12.5	4.0	7.0	0.5-2	5.6	20.0	14.583.03		50
16.5	5.0	9.0	1-4	11.0	21.0	14.583.04		50
20.5	8.0	13.0	1-4	13.4	25.5	14.583.05		50
25.5	11.0	17.0	1-4	15.3	30.5	14.583.06		50
32.5	15.0	20.0	1-4	18.6	38.5	14.583.07		25
40.5	19.0	28.0	1-4	21.7	48.5	14.583.08		25
50.5	27.0	35.0	1-4	25.0	60.5	14.583.09		10



Schwarz RAL 9005						Black RAL 9005		
ØA mm	> Ø < min mm	> Ø < max mm	M mm	C mm	ØD mm	Art.-Nr. Art. No.		
12.5	4.0	7.0	0.5-2	5.6	20.0	14.582.93		50
16.5	5.0	9.0	1-4	11.0	21.0	14.582.94		50
20.5	8.0	13.0	1-4	13.4	25.5	14.582.95		50
25.5	11.0	17.0	1-4	15.3	30.5	14.582.96		50
32.5	15.0	20.0	1-4	18.6	38.5	14.582.97		25
40.5	19.0	28.0	1-4	21.7	48.5	14.582.98		25
50.5	27.0	35.0	1-4	25.0	60.5	14.582.99		10

Material: Polyethylen
 Einsatztemperatur: -20°C / +70°C
 Schutzart: IP 54

Material: Polyethylene
 Temperature range: -20°C / +70°C
 Protection class: IP 54

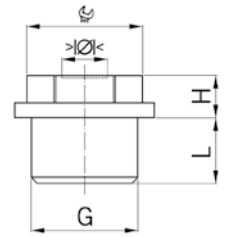

Hellgrau RAL 7035 mit Bohrung		Light grey RAL 7035 with bore hole		Art.-Nr. Art. No.			
G	$\begin{matrix} > \ominus < \\ \text{min mm} \end{matrix}$	$\begin{matrix} > \ominus < \\ \text{max mm} \end{matrix}$	$\begin{matrix} \text{mm} \\ \text{mm} \end{matrix}$	H mm	L mm		
M16x1.5	5.0	10.8	15	7	10	1620.17 100	
M20x1.5	8.0	13.5	19	8	12	1620.20 100	
M25x1.5	9.0	16.0	24	10	12	1620.25 100	
M32x1.5	11.0	22.0	30	11	14	1620.32 50	
M40x1.5	17.0	24.0	37	12	16	1620.40 25	
M50x1.5	22.0	35.0	46	13	18	1620.50 10	
M63x1.5	24.0	43.0	56	15	20	1620.63 10	



Hellgrau RAL 7035 ohne Bohrung		Light grey RAL 7035 without bore hole		Art.-Nr. Art. No.			
G	$\begin{matrix} > \ominus < \\ \text{min mm} \end{matrix}$	$\begin{matrix} > \ominus < \\ \text{max mm} \end{matrix}$	$\begin{matrix} \text{mm} \\ \text{mm} \end{matrix}$	H mm	L mm		
M16x1.5	5.0	10.8	15	7	10	1600.17 100	
M20x1.5	8.0	13.5	19	8	12	1600.20 100	
M25x1.5	9.0	16.0	24	10	12	1600.25 100	
M32x1.5	11.0	22.0	30	11	14	1600.32 100	
M40x1.5	17.0	24.0	37	12	16	1600.40 25	
M50x1.5	22.0	35.0	46	13	18	1600.50 10	
M63x1.5	24.0	43.0	56	15	20	1600.63 10	





Dank einer Reihe kleiner Helfer bei der Kabeleinführung lassen sich Produktionsanlagen problemlos an neue Aufgaben oder Gegebenheiten anpassen. Dabei kann nicht nur die Anzahl der Leitungen abweichen, sondern es können sich auch etliche Kabeldurchmesser ändern. Um hier den Arbeitsaufwand an Gehäusen und Schaltschränken zu minimieren, empfiehlt sich der Einsatz von Erweiterungen und Reduktionen. So können zum Beispiel einzelne Adern von dicken Kabeln durch eine Erweiterung in das Gehäuse eingeführt werden, wobei die äussere Leitungsisolierung in der Kabelverschraubung endet. Hierbei bleibt die vorhandene Schutzart selbstverständlich erhalten.

Überflüssige Gehäuseöffnungen werden durch den Einsatz von Verschlusschrauben abgedichtet und somit vor dem Eindringen von Schmutz bewahrt.











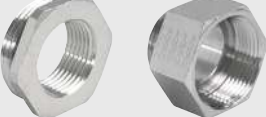

Falls keine Gewindebohrung vorhanden ist, können Gegenmuttern verwendet werden.

Thanks to a range of small accessories designed for the cable entry point, production systems can be easily adapted to take account of new tasks or new situations. Not only can the number of cables themselves change but cable diameters as well. To minimise the workload on housings and switchboards the use of extension or reduction fittings is recommended. An extension, for example, can be used to introduce the individual cores of thick cable into the housing with the outer cable insulation terminating in the cable gland. It goes without saying that the existing class of protection is maintained.

Redundant housing openings are sealed by locking screws to prevent the ingress of dirt.

If there is no tapped hole, locknuts can be used.



<p>Druckausgleichselemente Messing und Kunststoff Pressure balance elements nickel-plated brass and synthetics</p>		<p>202 - 205</p>	<p>1</p>
<p>Universal-Drehadapter und Richtungsfeststeller Messing Universal swivel adapter and adjustable fixing device nickel-plated brass</p>		<p>206</p>	<p>2</p>
<p>Gegenmuttern Metall Metal lock nuts</p>		<p>207 - 209</p>	<p>3</p>
<p>Gegenmuttern Kunststoff Synthetic lock nuts</p>		<p>210 - 211</p>	<p>4</p>
<p>Reduktionen und Erweiterungen Messing Reduction and enlarging fittings nickel-plated brass</p>		<p>212 - 220</p>	<p>5</p>
<p>Reduktionen und Erweiterungen Kunststoff Synthetic reduction and enlarging fittings</p>		<p>221 - 224</p>	<p>6</p>
<p>Verschlusschrauben Metall und Kunststoff Locking plugs metal and synthetic</p>		<p>225 - 229</p>	<p>7</p>
<p>Dichteinsätze Vollgummi Solid rubber sealing inserts</p>		<p>230</p>	<p>8</p>
<p>O-Ringe und Dichtungsscheiben O-rings and sealing washers</p>		<p>231 - 232</p>	<p>9</p>
<p>Blindscheiben, Verschlussbolzen, Einschnittringe Blind discs, locking pins, sealing rings</p>		<p>233 - 234</p>	<p>10</p>
<p>Spezialwerkzeug Special tool</p>		<p>235</p>	<p>11</p>
<p>AGRO Geflechschläuche Kunststoff AGRO synthetic braided cable sleeving</p>		<p>236 - 239</p>	<p>12</p>

Druckausgleichselement Messing und Kunststoff

Pressure balance element nickel-plated brass and synthetic

Anschlussgewinde metrisch | Entry thread metric

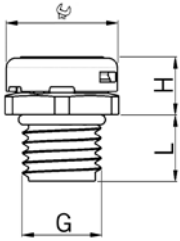

Kunststoff Druckausgleichselement mit Membrane

Material:	Polyamid PA 6
Membrane:	PES Polyethersulfon
O-Ring:	NBR
Einsatztemperatur:	-40°C / +100°C
Schutzart:	IP 66 / IP 68 / IP 69
Wassereintrittsdruck:	> 12.0 psi / 0.83 bar
Luftdurchsatz:	> 90ml / min / cm ² bei 10mbar
Eigenschaften:	halogenfrei, UV beständig (getestet nach EN ISO 4892-2)

Synthetic pressure balance element with membrane

Material:	Polyamide PA 6
Membrane:	PES polyethersulfone
O-ring:	NBR
Temperature range:	-40°C / +100°C
Protection class:	IP 66 / IP 68 / IP 69
Water intrusion pressure:	> 12.0 psi / 0.83 bar
Air flow rate:	> 90ml / min / cm ² at 10mbar
Properties:	halogen-free, UV resistant (tested according to EN ISO 4892-2)



mit Membrane
Schwarz RAL 9005

with membrane
Black RAL 9001

G	 mm	H mm	L mm
M12x1.5	17	9	10

Art.-Nr. | Art. No.



2445.12

25

Anschlussgewinde metrisch | Entry thread metric

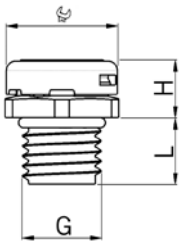

Kunststoff Druckausgleichselement mit Membrane

Material:	Polyamid PA 6
Membrane:	PES Polyethersulfon
O-Ring:	NBR
Einsatztemperatur:	-40°C / +100°C
Schutzart:	IP 66 / IP 68 / IP 69
Wassereintrittsdruck:	> 12.0 psi / 0.83 bar
Luftdurchsatz:	> 90ml / min / cm ² bei 10mbar
Eigenschaften:	halogenfrei

Synthetic pressure balance element with membrane

Material:	Polyamide PA 6
Membrane:	PES polyethersulfone
O-ring:	NBR
Temperature range:	-40°C / +100°C
Protection class:	IP 66 / IP 68 / IP 69
Water intrusion pressure:	> 12.0 psi / 0.83 bar
Air flow rate:	> 90ml / min / cm ² at 10mbar
Properties:	halogen-free



mit Membrane
Hellgrau RAL 7035

with membrane
Light grey RAL 7035

G	 mm	H mm	L mm
M12x1.5	17	9	10

Art.-Nr. | Art. No.



2455.12

25

Druckausgleichselement Messing mit Membrane

Pressure balance element nickel-plated brass and synthetic

Anschlussgewinde metrisch | Entry thread metric

Material:	Messing vernickelt	Material:	Nickel-plated brass
Membrane:	PES Polyethersulfon	Membrane:	PES polyethersulfone
O-Ring:	NBR	O-ring:	NBR
Einsatztemperatur:	-60°C / +100°C	Temperature range:	-60°C / +100°C
Schutzart:	IP 66 / IP 68 / IP 69	Protection class:	IP 66 / IP 68 / IP 69
Wassereintrittsdruck:	> 12.0 psi / 0.83 bar	Water intrusion pressure:	> 12.0 psi / 0.83 bar
Luftdurchsatz:	> 90ml / min / cm ² bei 10mbar	Air flow rate:	> 90ml / min / cm ² at 10mbar

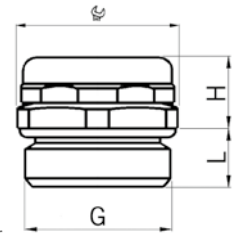

mit Membrane mit O-Ring		with membrane with O-ring	
G		H	L
	mm	mm	mm
M12x1.5	18	9.5	8
M16x1.5	18	9.5	8
M20x1.5	22	10.0	8
Auf Anfrage lieferbar: Rostfreier Stahl A2 oder A4		Available on request: Stainless steel A2 or A4	
Für hohe Temperaturen (+200°C)		Für hohe Temperaturen (+200°C)	

Art.-Nr. | Art. No.



2450.12.34	25
2450.17.34	20
2450.20.34	20



Anschlussgewinde Pg | Entry thread Pg

mit Membrane mit O-Ring		with membrane with O-ring	
G		H	L
	mm	mm	mm
Pg 7	18	9.5	8
Pg 11	22	10.0	8
Auf Anfrage lieferbar: Rostfreier Stahl A2 oder A4		Available on request: Stainless steel A2 or A4	
Für hohe Temperaturen (+200°C)		Für hohe Temperaturen (+200°C)	

Art.-Nr. | Art. No.



2450.07.34	25
2450.11.34	20



Anschlussgewinde metrisch | Entry thread metric

Druckausgleichselement mit Membrane erhöhte Sicherheit Ex e II

Pressure balance element with membrane increased safety Ex e II

Material:	Messing vernickelt	Material:	Nickel-plated brass
Membrane:	PES Polyethersulfon	Membrane:	PES polyethersulfone
O-Ring:	FPM	O-ring:	FPM
Einsatztemperatur:	-60°C / +100°C	Temperature range:	-60°C / +100°C
Schutzart:	IP 66 / IP 68 / IP 69	Protection class:	IP 66 / IP 68 / IP 69
Prüfnorm:	IEC EN 60079-0 / IEC EN 60079-7 / IEC EN 60079-31	Test standard:	IEC EN 60079-0 / IEC EN 60079-7 / IEC EN 60079-31
Gas:	II 2G Ex eb IIC Gb	Gas:	II 2G Ex eb IIC Gb
Staub:	II 2D Ex tb IIIC Db	Dust:	II 2D Ex tb IIIC Db
Zone:	Gas 1 und 2 / Staub 21 und 22	Zone:	Gas 1 and 2 / dust 21 and 22
Zertifikat:	SEV 16 ATEX 0143	Certificate:	SEV 16 ATEX 0143
IECEx Zertifikat:	IECEx SEV 16.0010	IECEx Certificate:	IECEx SEV 16.0010

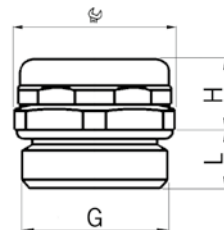

EX DAE



mit Membrane mit O-Ring		with membrane with O-ring	
G		H	L
	mm	mm	mm
M12x1.5	18	9.5	8
M16x1.5	18	9.5	8
M20x1.5	22	10.0	8
Auf Anfrage lieferbar: Rostfreier Stahl A2 oder A4		Available on request: Stainless steel A2 or A4	
Anschlussgewinde Pg		Entry thread Pg	

Art.-Nr. | Art. No.



EX2450.12.34	25
EX2450.17.34	20
EX2450.20.34	20



Druckausgleichselement Messing und Kunststoff

Pressure balance element nickel-plated brass and synthetic

Anschlussgewinde metrisch | Entry thread metric

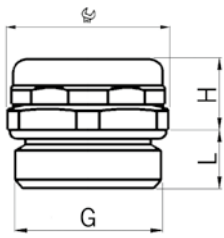

Druckausgleichselement Messing mit Sinterfilter

Material:	Messing vernickelt
Filterscheibe:	Sinterbronze
O-Ring:	NBR
Einsatztemperatur:	-50°C / +110°C
Schutzart:	IP 54 / IP x9
Filtergrad:	40 µm

Pressure balance element nickel-plated brass with sintered filter

Material:	Nickel-plated brass
Filter disc:	Sintered bronze
O-ring:	NBR
Temperature range:	-50°C / +110°C
Protection class:	IP 54 / IP x9
Degree of filter:	40 µm



mit Sinterfilter
mit O-Ring

G	$\frac{G}{mm}$	H mm	L mm
M12x1.5	18	9.5	8
M16x1.5	18	9.5	8
M20x1.5	22	10.0	8

Auf Anfrage lieferbar:
Rostfreier Stahl A2 oder A4
Für hohe Temperaturen (+200°C)

Sintered filter
with O-ring

Art.-Nr. Art. No.	
2450.12.32	25
2450.17.32	20
2450.20.32	20

Available on request:
Stainless steel A2 or A4
For high temperature applications (+200°C)

Anschlussgewinde Pg | Entry thread Pg



mit Sinterfilter
mit O-Ring

G	$\frac{G}{mm}$	H mm	L mm
Pg 7	18	9.5	8
Pg 11	22	10.0	8

Auf Anfrage lieferbar:
Rostfreier Stahl A2 oder A4
Für hohe Temperaturen (+200°C)

Sintered filter
with O-ring

Art.-Nr. Art. No.	
2450.07.32	25
2450.11.32	20

Available on request:
Stainless steel A2 or A4
For high temperature applications (+200°C)

Druckausgleichselement Messing und Kunststoff

Pressure balance element nickel-plated brass and synthetic

Anschlussgewinde metrisch | Entry thread metric

Entwässerungselement mit Sieb

Material: Messing vernickelt
 Sieb: Rostfreier Stahl A2
 O-Ring: NBR
 Einsatztemperatur: -50°C / +110°C
 Schutzart: IP 4x

Drainage element with mesh

Material: Nickel-plated brass
 Mesh: Stainless steel A2
 O-ring: NBR
 Temperature range: -50°C / +110°C
 Protection class: IP 4x

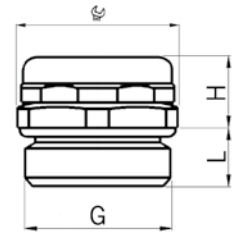

mit Sieb mit O-Ring		with mesh with O-ring		Art.-Nr. Art. No.	
G	mm	H mm	L mm		
M12x1.5	18	9.5	10	2450.12.36	25
M16x1.5	18	9.5	10	2450.17.36	20
M20x1.5	22	10.0	10	2450.20.36	20

Auf Anfrage lieferbar: Rostfreier Stahl A2 oder A4
 Available on request: Stainless steel A2 or A4



Anschlussgewinde metrisch | Entry thread metric

Gegenmutter zu Entwässerungselement

Material: Messing vernickelt
 Einsatztemperatur: -50°C / +200°C

Lock nut for drainage element

Material: Nickel-plated brass
 Temperature range: -50°C / +200°C

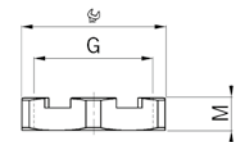

zum Entwässerungselement		for drainage element		Art.-Nr. Art. No.	
G	mm	H mm	L mm		
M12x1.5	15	4.5		8324.12	25
M16x1.5	19	5.5		8324.17	20
M20x1.5	24	5.5		8324.20	20



1
2
3
4
5
6
7
8
9
10
11
12

Universal Drehadapter, Richtungsfeststeller Messing

Universal swivel adapter, adjustable fixing devices nickel-plated brass

Kurzes Anschlussgewinde metrisch | Short entry thread metric

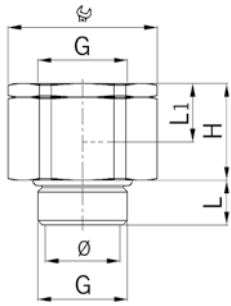

AGRO Universal-Drehadapter Messing

Material: Messing vernickelt
 Dichtringe: NBR
 Einsatztemperatur: -40°C / +100°C
 Schutzart: IP 68
 Eigenschaften: Universell verwendbar mit Kabel- oder Schlauchverschraubungen, gute Drehfreudigkeit durch spezielle Lagerung

AGRO universal swivel adapter nickel-plated brass

Material: Nickel-plated brass
 Sealing rings: NBR
 Temperature range: -40°C / +100°C
 Protection class: IP 68
 Properties: Multifunctional use in combination with cable- or conduit glands, smooth rotation due to a special bearing



G	$\frac{G}{mm}$	H mm	L mm	L1 mm	Ø mm	Art.-Nr. Art. No.	
M16x1.5	24	20	10	12	11.0	2410.17	25
M20x1.5	30	22	10	13	15.5	2410.20	25
M25x1.5	36	24	11	13	20.5	2410.25	25
M32x1.5	46	27	13	14	28.0	2410.32	10
M40x1.5	55	28	13	15	37.0	2410.40	10
M50x1.5	65	32	14	16.5	43.0	2410.50	5

Achtung! Der Universal-Drehadapter kann kein Kugel- oder Wälzlager ersetzen! Attention! The swivel adapter can not replace rolling- or ball bearings!

Anschlussgewinde metrisch | Entry thread metric

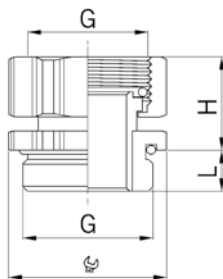

Material: Messing vernickelt
 O-Ring: 2 x NBR
 Einsatztemperatur: -40°C / +100°C
 Schutzart: IP 68
 Einsatzbereich: Besonders geeignet für die richtungsstabile Montage von Winkeln

Material: Nickel-plated brass
 O-ring: 2 x NBR
 Temperature range: -40°C / +100°C
 Protection class: IP 68
 Application: Suitable for directionally stable mounting of elbows



G	$\frac{G}{mm}$	H mm	L mm	Art.-Nr. Art. No.	
M16x1.5	18	14	6	5000.17.50	50
M20x1.5	22	14	6	5000.20.50	50
M25x1.5	28	15	7	5000.25.50	50
M32x1.5	35	18	8	5000.32.50	50

Gegenmuttern Messing

Lock nuts nickel-plated brass

Anschlussgewinde metrisch | Entry thread metric

Material: Messing vernickelt
 Ausführung: 6-kant
 Einsatztemperatur: -40°C / +200°C

Material: Nickel-plated brass
 Execution: Hexagonal design
 Temperature range: -40°C / +200°C

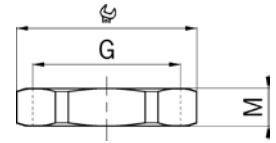

Gewinde metrisch				Metric thread		
G	$\frac{G}{mm}$	M	i	Art.-Nr. Art. No.		
	mm	mm	info			
M6x0.75	9	2.8	-	8000.06.1	50	
M6x1.0	9	2.8	1	8000.06	50	
M8x1.0	11	2.8	-	8000.08.1	50	
M8x1.25	11	2.8	1	8000.08	50	
M10x1.0	13	2.8	-	8000.10.1	50	
M10x1.5	13	2.8	1	8000.10	50	
M12x1.5	15	3.0	-	8000.12	100	
M16x1.5	19	3.0	-	8000.17	100	
M20x1.5	24	3.5	-	8000.20	100	
M25x1.5	30	4.0	-	8000.25	50	
M32x1.5	36	4.0	-	8000.32	25	
M40x1.5	46	5.0	-	8000.40	25	
M50x1.5	55	5.5	-	8000.50	10	
M63x1.5	70	6.0	-	8000.63	10	
M75x1.5	80	6.0	-	8000.75	10	
M80x2.0	95	8	-	8000.080	5	
M85x2.0	95	8.0	-	8000.085	5	
M95x2.0	110	9.0	-	8000.095	5	
M100x3.0	115	9.0	-	8000.100	1	
M105x3.0	120	9.0	-	8000.105	1	
M115x3.0	125	10.0	-	8000.115	1	

1 = Metrisches Regelgewinde 1 = Metric coarse-pitch thread



Anschlussgewinde Pg | Entry thread Pg

Gewinde Pg			Pg thread		
G	$\frac{G}{mm}$	M	Art.-Nr. Art. No.		
	mm	mm			
Pg 7	15	3.0	8007	50	
Pg 9	18	3.0	8009	50	
Pg 11	21	3.0	8011	50	
Pg 13	23	3.0	8013	50	
Pg 16	26	3.0	8016	50	
Pg 21	32	3.5	8021	25	
Pg 29	41	4.0	8029	10	
Pg 36	51	5.0	8036	10	
Pg 42	60	5.0	8042	10	
Pg 48	65	5.5	8048.48	10	



Anschlussgewinde Gasrohr | Gas-pipe entry thread

Gasrohr-Gewinde				Gas-pipe thread		
G	$\frac{G}{mm}$	M	i	Art.-Nr. Art. No.		
	mm	mm	info			
G 3/8"	19	3.0	-	803/8G	10	
G 1/2"	24	3.0	-	801/2G	10	
G 5/8"	26	3.0	-	805/8G	10	
G 3/4"	30	3.5	-	803/4G	10	
G 1"	38	4.5	-	801G	10	
G 1 1/2"	51	5.0	-	8011/2G	10	
G 1 1/4"	46	5.0	-	8011/4G	10	
G 2"	65	5.5	-	8048	5	
G 2 1/2"	90	12.0	1	8050	5	
G 3"	105	12.0	1	8051	5	

1 = Runde Bauform, Stahl verzinkt 1 = Round form, zinc coated steel



Gegenmuttern Messing

Lock nuts nickel-plated brass

Anschlussgewinde metrisch | Entry thread metric

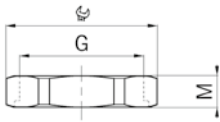



Gegenmuttern Messing, dicke Ausführung

Material: Messing vernickelt
 Ausführung: 6-kant
 Einsatztemperatur: -40°C / +200°C

Lock nuts nickel-plated brass, thick-walled version



Material: Nickel-plated brass
 Execution: Hexagonal design
 Temperature range: -40°C / +200°C



Dicke Ausführung			Thick-walled version		
G	 mm	M mm	Art.-Nr. Art. No.		
M12x1.5	15	5.0	8300.12	50	
M16x1.5	19	5.0	8300.17	50	
M20x1.5	24	5.5	8300.20	50	
M25x1.5	30	5.5	8300.25	50	
M32x1.5	36	6.0	8300.32	50	
M40x1.5	46	7.0	8300.40	50	

Anschlussgewinde Pg | Entry thread Pg



Dicke Ausführung			Thick-walled version		
G	 mm	M mm	Art.-Nr. Art. No.		
Pg 7	15	5.0	8300.07	50	
Pg 9	18	5.0	8300.09	50	
Pg 11	21	5.0	8300.11	50	
Pg 13	24	5.5	8300.13	50	
Pg 16	26	5.5	8300.16	50	
Pg 21	32	6.0	8300.21	50	
Pg 29	41	7.0	8300.29	50	

Anschlussgewinde metrisch | Filet de raccordement métrique

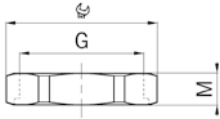



Gegenmuttern Messing mit Hinterstich für O-Ring

Material: Messing vernickelt
 Ausführung: 6-kant
 O-Ring: Separat bestellen
 Einsatztemperatur: -40°C / +200°C

Lock nuts nickel-plated brass with recess for O-ring

Material: Nickel-plated brass
 Execution: Hexagonal design
 O-ring: To be ordered separately
 Temperature range: -40°C / +200°C



Dicke Ausführung ohne O-Ring				Thick-walled version without O-Ring		
G	 mm	M mm	O-ring	Art.-Nr. Art. No.		
M12x1.5	15	5.0	1007.00.08	8300.12.1	50	
M16x1.5	19	5.0	1016.00.15.08	8300.17.1	50	
M20x1.5	24	5.5	1016.00.08	8300.20.1	50	
M25x1.5	30	5.5	1013.00.22.08	8300.25.1	50	
M32x1.5	36	6.0	1021.00.30.08	8300.32.1	50	
M40x1.5	46	7.0	1029.00.39.08	8300.40.1	50	
M50x1.5	55	7.5	1036.00.49.08	8300.50.1	10	
M63x1.5	70	8.0	1048.00.62.08	8300.63.1	10	

Gegenmutter rostfreier Stahl

Stainless steel lock nuts

Rostfreier Stahl A2 | Stainless steel A2

Material: Rostfreier CrNi-Stahl A2
(DIN EN 1.4305 / AISI 303)

Ausführung: 6-kant



Einsatztemperatur: -40°C / +300°C

Material: CrNi stainless steel A2
(DIN EN 1.4305 / AISI 303)

Execution: Hexagonal design

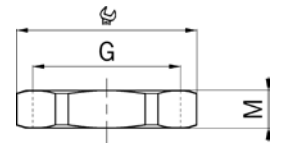

Temperature range: -40°C / +300°C



Gewinde metrisch				Metric thread		
G		M	i	Art.-Nr. Art. No.		
	mm	mm	info			
M8x1.25	11	2.8	1	8008.96	50	
M10x1.5	13	2.8	1	8010.96	50	
M12x1.5	17	3.0	-	8012.96	50	
M16x1.5	19	3.0	-	8017.96	50	
M20x1.5	24	3.5	-	8020.96	50	
M25x1.5	30	3.5	-	8025.96	25	
M32x1.5	36	4.5	-	8032.96	25	
M40x1.5	46	4.5	-	8040.96	10	
M50x1.5	55	5.5	-	8050.96	10	
M63x1.5	70	6.0	-	8063.96	5	

1 = Metrisches Regelgewinde 1 = Metric coarse-pitch thread



Gewinde Pg			Pg thread		
G		M	Art.-Nr. Art. No.		
	mm	mm			
Pg 7	17	3.5	8007.96	50	
Pg 9	19	3.5	8009.96	50	
Pg 11	22	3.5	8011.96	50	
Pg 13	24	4.0	8013.96	50	
Pg 16	27	4.0	8016.96	50	
Pg 21	32	4.5	8021.96	25	
Pg 29	41	5.5	8029.96	10	
Pg 36	51	6.0	8036.96	10	



Rostfreier und säurebeständiger Stahl A4 | Stainless steel and acid resistant A4

Material: Rostfreier und säurebeständiger CrNiMo-Stahl A4
(DIN EN 1.4435 / AISI 316L)

Ausführung: 6-kant



Einsatztemperatur: -40°C / +300°C

Material: Stainless and acid resistant steel A4 CrNiMo (DIN EN 1.4435 / AISI 316L)

Execution: Hexagonal design

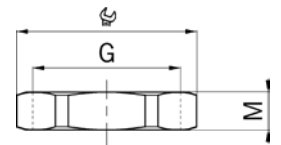
Temperature range: -40°C / +300°C



Gewinde metrisch				Metric thread		
G		M	i	Art.-Nr. Art. No.		
	mm	mm	info			
M8x1.25	11	2.8	1	8008.98	50	
M10x1.5	13	2.8	1	8010.98	50	
M12x1.5	17	3.0	-	8012.98	50	
M16x1.5	19	3.0	-	8017.98	50	
M20x1.5	24	3.5	-	8020.98	50	
M25x1.5	30	3.5	-	8025.98	25	
M32x1.5	36	4.5	-	8032.98	25	
M40x1.5	46	4.5	-	8040.98	10	
M50x1.5	55	5.5	-	8050.98	10	
M63x1.5	70	6.0	-	8063.98	5	

1 = Metrisches Regelgewinde 1 = Metric coarse-pitch thread



Gegenmuttern Kunststoff

Synthetic lock nuts

Anschlussgewinde metrisch | Entry thread metric

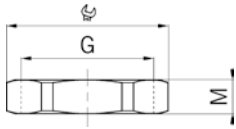

Material: Polyamid glasfaserverstärkt
 Eigenschaften: halogenfrei
 Ausführung: 6-kant
 Einsatztemperatur: -40°C / +100°C

Material: Polyamide glass fiber reinforced
 Properties: halogen-free
 Execution: Hexagonal design
 Temperature range: -40°C / +100°C



Hellgrau RAL 7035

Light grey RAL 7035

G		M mm	Art.-Nr. Art. No.	
M12x1.5	17	5.5	8212	100
M16x1.5	22	5.5	8217	100
M20x1.5	26	6.5	8220	100
M25x1.5	32	7.0	8225	100
M32x1.5	41	7.0	8232	100
M40x1.5	50	7.0	8240	50
M50x1.5	60	8.5	8250	10



Schwarz RAL 9005

Black RAL 9005

G		M mm	Art.-Nr. Art. No.	
M12x1.5	17	5.5	8212.40	100
M16x1.5	22	5.5	8217.40	100
M20x1.5	26	6.5	8220.40	100
M25x1.5	32	7.0	8225.40	100
M32x1.5	41	7.0	8232.40	100
M40x1.5	50	7.0	8240.40	50
M50x1.5	60	8.5	8250.40	10

Anschlussgewinde Pg | Entry thread Pg



Hellgrau RAL 7035

Light grey RAL 7035

G		M mm	Art.-Nr. Art. No.	
Pg 7	19	5.0	8207	100
Pg 9	22	6.0	8209	100
Pg 11	24	6.0	8211	100
Pg 13	27	6.0	8213	100
Pg 16	30	6.0	8216	100
Pg 21	36	7.0	8221	100
Pg 29	46	7.0	8229	50
Pg 36	60	8.0	8236	25
Pg 42	65	8.0	8242	25
Pg 48	70	8.0	8248.48	25



Schwarz RAL 9005

Black RAL 9005

G		M mm	Art.-Nr. Art. No.	
Pg 7	19	5.0	8207.40	100
Pg 9	22	6.0	8209.40	100
Pg 11	24	6.0	8211.40	100
Pg 13	27	6.0	8213.40	100
Pg 16	30	6.0	8216.40	100
Pg 21	36	7.0	8221.40	100
Pg 29	46	7.0	8229.40	50
Pg 36	60	8.0	8236.40	25
Pg 42	65	8.0	8242.40	25
Pg 48	70	8.0	8248.48.40	25

Anschlussgewinde metrisch | Entry thread metric



Gegenmuttern Kunststoff mit Flansch

Synthetic lock nuts with flange

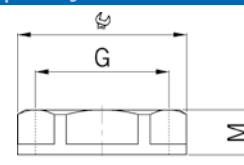

Material: Polyamid PA 6
 Eigenschaften: halogenfrei
 Ausführung: 6-kant mit Flansch
 Einsatztemperatur: -30°C / +100°C

Material: Polyamide PA 6
 Properties: halogen-free
 Execution: Hexagonal design with flange
 Temperature range: -30°C / +100°C





Hellgrau RAL 7035			Light grey RAL 7035		
G	 mm	M mm	Art.-Nr. Art. No.		
M12x1.5	17	5.0	8255.12	100	
M16x1.5	22	5.0	8255.17	100	
M20x1.5	27	6.0	8255.20	100	
M25x1.5	33	6.7	8255.25	100	
M32x1.5	42	7.9	8255.32	50	
M40x1.5	48	8.4	8255.40	50	
M50x1.5	59	9.9	8255.50	10	
M63x1.5	73	11.0	8255.63	10	





Schwarz RAL 9005			Black RAL 9005		
G	 mm	M mm	Art.-Nr. Art. No.		
M12x1.5	17	5.0	8245.12	100	
M16x1.5	22	5.0	8245.17	100	
M20x1.5	27	6.0	8245.20	100	
M25x1.5	33	6.7	8245.25	100	
M32x1.5	42	7.9	8245.32	50	
M40x1.5	48	8.4	8245.40	50	
M50x1.5	59	9.9	8245.50	10	
M63x1.5	73	11.0	8245.63	10	



Anschlussgewinde Pg | Entry thread Pg

Hellgrau RAL 7035			Light grey RAL 7035		
G	 mm	M mm	Art.-Nr. Art. No.		
Pg 7	19	5.0	8255.07	100	
Pg 9	21	5.0	8255.09	100	
Pg 11	24	5.0	8255.11	100	
Pg 13	27	6.0	8255.13	100	
Pg 16	30	6.0	8255.16	100	
Pg 21	36	7.0	8255.21	50	
Pg 29	46	8.0	8255.29	25	
Pg 36	59	8.0	8255.36	25	
Pg 42	65	8.0	8255.42	10	
Pg 48	69	8.0	8255.48	10	



Schwarz RAL 9005			Black RAL 9005		
G	 mm	M mm	Art.-Nr. Art. No.		
Pg 7	19	5.0	8245.07	100	
Pg 9	21	5.0	8245.09	100	
Pg 11	24	5.0	8245.11	100	
Pg 13	27	6.0	8245.13	100	
Pg 16	30	6.0	8245.16	100	
Pg 21	36	7.0	8245.21	50	
Pg 29	46	8.0	8245.29	50	
Pg 36	59	8.0	8245.36	25	
Pg 42	65	8.0	8245.42	10	
Pg 48	69	8.0	8245.48	10	



Reduktionen Messing

Reduction fittings nickel-plated brass

mit 6-kant | hexagonal

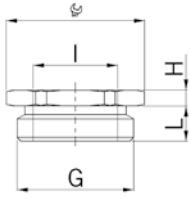

Material: Messing vernickelt
 O-Ring: NBR
 Einsatztemperatur: -40°C / +100°C
 Schutzart: IP 68

Material: Nickel-plated brass
 O-ring: NBR
 Temperature range: -40°C / +100°C
 Protection class: IP 68



Aussengewinde metrisch
 Innengewinde metrisch
 mit O-Ring

Outer thread metric
 Inner thread metric
 with O-ring

G	I	$\frac{G}{mm}$	H mm	L mm	i info	Art.-Nr. Art. No.	
M 8x1.25	M 6x1.0	11	8.0	5	1	3500.08.06	50
M10x1.5	M 6x1.0	13	3.0	5	1	3500.10.06	50
M10x1.5	M 8x1.25	13	8.0	5	1	3500.10.08	50
M12x1.5	M 8x1.25	15	3.0	5	1	3500.12.08	50
M12x1.5	M10x1.5	15	8.0	5	1	3500.12.10	50
M16x1.5	M10x1.5	18	3.0	5	1	3500.17.10	50
M16x1.5	M12x1.5	18	3.0	5	-	3500.17.12	50
M20x1.5	M12x1.5	24	3.0	6	-	3500.20.12	50
M20x1.5	M16x1.5	24	3.0	6	-	3500.20.17	50
M25x1.5	M16x1.5	30	3.5	7	-	3500.25.17	25
M25x1.5	M20x1.5	30	3.5	7	-	3500.25.20	25
M32x1.5	M20x1.5	36	4.0	8	-	3500.32.20	20
M32x1.5	M25x1.5	36	4.0	8	-	3500.32.25	20
M40x1.5	M25x1.5	46	4.5	8	-	3500.40.25	10
M40x1.5	M32x1.5	46	4.5	8	-	3500.40.32	10
M50x1.5	M32x1.5	55	5.0	9	-	3500.50.32	10
M50x1.5	M40x1.5	55	5.0	9	-	3500.50.40	10
M63x1.5	M40x1.5	70	5.5	10	-	3500.63.40	5
M63x1.5	M50x1.5	70	5.5	10	-	3500.63.50	5
M75x1.5	M50x1.5	80	6.0	11	-	3500.75.50	5
M75x1.5	M63x1.5	80	6.0	11	-	3500.75.63	5

1 = Metrisches Regelgewinde

1 = Metric coarse-pitch thread

Runde Bauform, randriert | Round, knurled

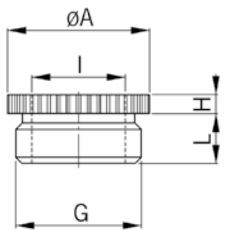

Material: Messing vernickelt
 Einsatztemperatur: -40°C / +200°C
 Schutzart: IP 54
 Weitere Schutzart: IP 68, wenn Anschlussge-
 winde abgedichtet

Material: Nickel-plated brass
 Temperature range: -40°C / +200°C
 Protection class: IP 54
 Further protection: IP 68, if the entry thread
 is sealed



Aussengewinde metrisch
 Innengewinde metrisch
 ohne O-Ring

Outer thread metric
 Inner thread metric
 without O-Ring

G	I	ØA mm	H mm	L mm	Art.-Nr. Art. No.	
M16x1.5	M12x1.5	18	3	7	3545.17.12	100
M20x1.5	M12x1.5	22	3	8	3545.20.12	100
M20x1.5	M16x1.5	22	3	8	3545.20.17	100
M25x1.5	M16x1.5	27	3	8	3545.25.17	50
M25x1.5	M20x1.5	27	3	8	3545.25.20	50
M32x1.5	M20x1.5	34	4	9	3545.32.20	50
M32x1.5	M25x1.5	34	4	9	3545.32.25	50
M40x1.5	M25x1.5	42	4.5	9	3545.40.25	50
M40x1.5	M32x1.5	42	4.5	9	3545.40.32	25
M50x1.5	M32x1.5	52	4.5	10	3545.50.32	25
M50x1.5	M40x1.5	52	4.5	10	3545.50.40	10
M63x1.5	M40x1.5	65	5	11	3545.63.40	10
M63x1.5	M50x1.5	65	5	11	3545.63.50	10

mit 6-kant | hexagonal

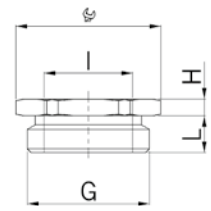

Material: Messing vernickelt
 O-Ring: NBR
 Einsatztemperatur: -40°C / +100°C
 Schutzart: IP 68

Material: Nickel-plated brass
 O-ring: NBR
 Temperature range: -40°C / +100°C
 Protection class: IP 68



Aussengewinde Pg
 Innengewinde Pg
 mit O-Ring

Outer thread Pg
 Inner thread Pg
 with O-ring

G	I	 mm	H mm	L mm	Art.-Nr. Art. No.	
Pg 9	Pg 7	18	3.0	6.5	3509.07	50
Pg 11	Pg 7	20	3.0	6.5	3511.07	50
Pg 11	Pg 9	22	3.0	7.0	3511.09	50
Pg 13	Pg 7	24	3.0	7.0	3513.07	50
Pg 13	Pg 9	24	3.0	7.0	3513.09	50
Pg 13	Pg 11	24	3.0	7.0	3513.11	50
Pg 16	Pg 9	24	3.0	7.0	3516.09	50
Pg 16	Pg 11	24	3.0	7.0	3516.11	50
Pg 16	Pg 13	27	3.0	7.0	3516.13	50
Pg 21	Pg 11	32	3.5	7.5	3521.11	25
Pg 21	Pg 13	32	3.5	7.5	3521.13	25
Pg 21	Pg 16	32	3.5	7.5	3521.16	25
Pg 29	Pg 13	38	4.0	8.0	3529.13	10
Pg 29	Pg 16	38	4.0	8.0	3529.16	10
Pg 29	Pg 21	38	4.0	8.0	3529.21	10
Pg 36	Pg 21	50	4.5	8.5	3536.21	10
Pg 36	Pg 29	50	4.5	8.5	3536.29	10
Pg 42	Pg 29	60	4.0	11.0	3542.29	10
Pg 42	Pg 36	60	4.0	11.0	3542.36	10
Pg 48	Pg 36	65	4.0	11.0	3548.48.36	10

1
2
3
4
5
6
7
8
9
10
11
12

Erweiterungen Messing

Enlarging fittings nickel-plated brass

mit 6-kant | hexagonal

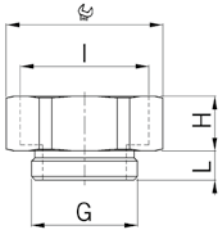



Material: Messing vernickelt
 O-Ring: NBR
 Einsatztemperatur: -40°C / +100°C
 Schutzart: IP 68

Material: Nickel-plated brass
 O-ring: NBR
 Temperature range: -40°C / +100°C
 Protection class: IP 68



Aussengewinde metrisch
 Innengewinde metrisch
 mit O-Ring

Outer thread metric
 Inner thread metric
 with O-ring

G	I	 mm	H mm	L mm	i info	Art.-Nr. Art. No.	
M 6x1.0	M 8x1.25	11	8.5	5	1	3600.06.08	50
M 6x1.0	M10x1.5	13	8.5	5	1	3600.06.10	50
M 8x1.25	M10x1.5	13	9	5	1	3600.08.10	50
M 8x1.25	M12x1.5	15	9	5	1	3600.08.12	50
M10x1.5	M12x1.5	15	9	5	1	3600.10.12	50
M10x1.5	M16x1.5	18	9	5	1	3600.10.17	50
M12x1.5	M16x1.5	18	9	5	-	3600.12.17	50
M12x1.5	M20x1.5	24	10	5	-	3600.12.20	50
M16x1.5	M20x1.5	24	10	5	-	3600.17.20	50
M20x1.5	M25x1.5	30	11.5	6	-	3600.20.25	25
M25x1.5	M32x1.5	36	14	7	-	3600.25.32	25
M32x1.5	M40x1.5	46	14	8	-	3600.32.40	25
M40x1.5	M50x1.5	55	16	8	-	3600.40.50	10
M50x1.5	M63x1.5	70	17	9	-	3600.50.63	10
M63x1.5	M75x1.5	80	18	10	-	3600.63.75	10

1 = Metrisches Regelgewinde

1 = Metric coarse-pitch thread

Runde Bauform, randriert | Round, knurled

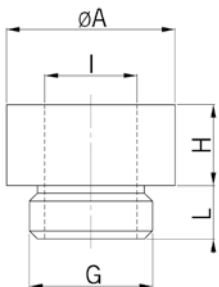

Material: Messing vernickelt
 Einsatztemperatur: -40°C / +200°C
 Schutzart: IP 54
 Weitere Schutzart: IP 68, wenn Anschlussge-
 winde abgedichtet

Material: Nickel-plated brass
 Temperature range: -40°C / +200°C
 Protection class: IP 54
 Further protection: IP 68, if the entry thread
 is sealed



Aussengewinde metrisch
 Innengewinde metrisch
 ohne O-Ring

Outer thread metric
 Inner thread metric
 without O-Ring

G	I	ØA mm	H mm	L mm	Art.-Nr. Art. No.	
M12x1.5	M16x1.5	19	9.5	6.5	3645.12.17	100
M16x1.5	M20x1.5	22	10.5	7	3645.17.20	100
M20x1.5	M25x1.5	27	11	8	3645.20.25	100
M25x1.5	M32x1.5	34	12	8	3645.25.32	50
M32x1.5	M40x1.5	42	12	9	3645.32.40	50
M40x1.5	M50x1.5	53	14	9	3645.40.50	25
M50x1.5	M63x1.5	66	19	10	3645.50.63	25

mit 6-kant | hexagonal

Material: Messing vernickelt
O-Ring: NBR
Einsatztemperatur: -40°C / +100°C
Schutzart: IP 68

Material: Nickel-plated brass
O-ring: NBR
Temperature range: -40°C / +100°C
Protection class: IP 68

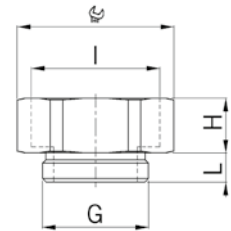

Aussengewinde Pg
Innengewinde Pg
mit O-Ring

Outer thread Pg
Inner thread Pg
with O-ring

G	I	 mm	H mm	L mm	Art.-Nr. Art. No.	
Pg 7	Pg 9	18	13	8	3607.09.08	50
Pg 9	Pg 11	22	15	8	3609.11.08	50
Pg 9	Pg 13	24	15	8	3609.13.08	50
Pg 11	Pg 13	24	15	8	3611.13.08	50
Pg 11	Pg 16	24	15	8	3611.16.08	50
Pg 11	Pg 21	32	16	8	3611.21.08	50
Pg 13	Pg 16	24	15	8	3613.16.08	50
Pg 13	Pg 21	32	16	8	3613.21.08	50
Pg 16	Pg 21	32	16	8	3616.21.08	25
Pg 16	Pg 29	40	16	8	3616.29.08	25
Pg 21	Pg 29	40	16	8	3621.29.08	25
Pg 29	Pg 36	50	18	10	3629.36.08	20
Pg 36	Pg 42	60	19	12	3636.42.08	10
Pg 36	Pg 48	64	20	12	3636.48.48.08	10



1
2
3
4
5
6
7
8
9
10
11
12

Adapter Messing

Adapter nickel-plated brass

mit 6-kant | hexagonal

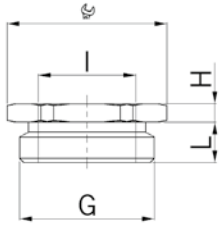

Material: Messing vernickelt
 O-Ring: NBR
 Einsatztemperatur: -40°C / +100°C
 Schutzart: IP 68

Material: Nickel-plated brass
 O-ring: NBR
 Temperature range: -40°C / +100°C
 Protection class: IP 68



Aussengewinde metrisch
 Innengewinde Pg
 mit O-Ring

Outer thread metric
 Inner thread Pg
 with O-ring

G	I	 mm	H mm	L mm	Art.-Nr. Art. No.	
M16x1.5	Pg 7	20	3.0	5	3500.17.07	50
M20x1.5	Pg 7	24	3.0	6	3500.20.07	50
M20x1.5	Pg 9	24	3.0	6	3500.20.09	50
M20x1.5	Pg 11	24	10.0	6	3500.20.11	50
M25x1.5	Pg 9	30	3.5	7	3500.25.09	50
M25x1.5	Pg 11	30	3.5	7	3500.25.11	50
M25x1.5	Pg 13	30	3.8	7	3500.25.13	50
M25x1.5	Pg 16	30	15.0	7	3500.25.16	25
M32x1.5	Pg 21	38	16.0	8	3500.32.21	25
M40x1.5	Pg 29	45	16.0	8	3500.40.29	10
M50x1.5	Pg 29	55	4.0	9	3500.50.29	10
M63x1.5	Pg 36	70	5.5	10	3500.63.36	10

mit 6-kant | hexagonal

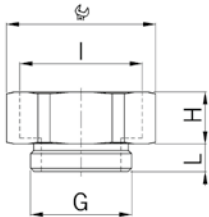



Material: Messing vernickelt
 O-Ring: NBR
 Einsatztemperatur: -40°C / +100°C
 Schutzart: IP 68

Material: Nickel-plated brass
 O-ring: NBR
 Temperature range: -40°C / +100°C
 Protection class: IP 68



Aussengewinde metrisch
 Innengewinde Pg
 mit O-Ring

Outer thread metric
 Inner thread Pg
 with O-ring

G	I	 mm	H mm	L mm	i info	Art.-Nr. Art. No.	
M10x1.5	Pg 7	16	12	5	1	3600.10.07	50
M10x1.5	Pg 9	18	12	5	1	3600.10.09	50
M12x1.5	Pg 9	18	12	5	-	3600.12.09	50
M16x1.5	Pg 11	22	14	5	-	3600.17.11	50
M20x1.5	Pg 13	24	15	6	-	3600.20.13	50
M20x1.5	Pg 16	24	15	6	-	3600.20.16	50
M25x1.5	Pg 21	32	16	7	-	3600.25.21	25
M32x1.5	Pg 29	40	16	8	-	3600.32.29	25
M40x1.5	Pg 36	50	18	8	-	3600.40.36	20
M50x1.5	Pg 42	60	19	9	-	3600.50.42	10
M50x1.5	Pg 48	64	20	9	-	3600.50.48	10

1 = Metrisches Regelgewinde

1 = Metric coarse-pitch thread

Adapter Messing

Adapter nickel-plated brass

mit 6-kant | hexagonal

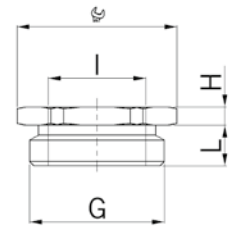

Material: Messing vernickelt
 O-Ring: NBR
 Einsatztemperatur: -40°C / +100°C
 Schutzart: IP 68

Material: Nickel-plated brass
 O-ring: NBR
 Temperature range: -40°C / +100°C
 Protection class: IP 68



Aussengewinde Pg
 Innengewinde metrisch
 mit O-Ring

Outer thread Pg
 Inner thread metric
 with O-ring

G	I	 mm	H mm	L mm	i info	Art.-Nr. Art. No.	
Pg 7	M 6x1.0	15	3.0	6	1	3500.07.06	50
Pg 7	M 8x1.25	15	3.0	6	1	3500.07.08	50
Pg 7	M 10x1.5	15	7.0	6	1	3500.07.10	50
Pg 9	M 6x1.0	18	3.0	6	1	3500.09.06	50
Pg 9	M 8x1.25	18	3.0	6	1	3500.09.08	50
Pg 9	M 10x1.5	18	3.0	6	1	3500.09.10	50
Pg 9	M 12x1.5	18	8.0	6	-	3500.09.12	50
Pg 11	M 6x1.0	21	3.0	6	1	3500.11.06	50
Pg 11	M 8x1.25	21	3.0	6	1	3500.11.08	50
Pg 11	M 10x1.5	21	3.0	6	1	3500.11.10	50
Pg 11	M 12x1.5	21	3.0	6	-	3500.11.12	50
Pg 11	M 16x1.5	21	8.0	6	-	3500.11.17	50
Pg 13	M 12x1.5	24	3.0	6	-	3500.13.12	50
Pg 13	M 16x1.5	24	3.0	6	-	3500.13.17	50
Pg 16	M 12x1.5	24	3.0	6	-	3500.16.12	25
Pg 16	M 16x1.5	24	3.0	6	-	3500.16.17	25
Pg 16	M 20x1.5	24	10.5	6	-	3500.16.20	25
Pg 21	M 16x1.5	30	3.5	7.5	-	3500.21.17	25
Pg 21	M 20x1.5	30	3.5	7.5	-	3500.21.20	25
Pg 21	M 25x1.5	30	10.5	7.5	-	3500.21.25	25
Pg 29	M 25x1.5	38	4.0	8	-	3500.29.25	20
Pg 29	M 32x1.5	38	13.0	8	-	3500.29.32	20
Pg 36	M 32x1.5	50	4.5	8	-	3500.36.32	10
Pg 36	M 40x1.5	50	4.5	8	-	3500.36.40	10
Pg 42	M 32x1.5	55	5.0	10	-	3500.42.32	10
Pg 42	M 40x1.5	55	5.0	10	-	3500.42.40	10
Pg 42	M 50x1.5	55	15.0	10	-	3500.42.50	10
Pg 48	M 40x1.5	65	5.5	11	-	3500.48.40	5
Pg 48	M 50x1.5	65	5.5	11	-	3500.48.50	5

1 = Metrisches Regelgewinde

1 = Metric coarse-pitch thread

Adapter Messing

Adapter nickel-plated brass

mit 6-kant | hexagonal

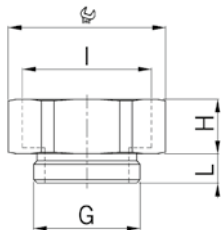

Material: Messing vernickelt
 O-Ring: NBR
 Einsatztemperatur: -40°C / +100°C
 Schutzart: IP 68

Material: Nickel-plated brass
 O-ring: NBR
 Temperature range: -40°C / +100°C
 Protection class: IP 68



Aussengewinde Pg
 Innengewinde metrisch
 mit O-Ring

Outer thread Pg
 Inner thread metric
 with O-ring

G	I	$\frac{PG}{mm}$	H mm	L mm	Art.-Nr. Art. No.	
Pg 7	M12x1.5	15	9.0	6	3600.07.12	50
Pg 7	M16x1.5	18	9.0	6	3600.07.17	50
Pg 9	M16x1.5	18	9.5	6	3600.09.17	50
Pg 9	M20x1.5	24	10.5	6	3600.09.20	50
Pg 11	M20x1.5	24	10.5	6	3600.11.20	50
Pg 11	M25x1.5	30	11.5	6	3600.11.25	25
Pg 13	M20x1.5	24	10.5	6	3600.13.20	50
Pg 13	M25x1.5	30	11.5	6	3600.13.25	25
Pg 16	M25x1.5	30	11.5	6	3600.16.25	25
Pg 16	M32x1.5	36	13.5	6	3600.16.32	25
Pg 21	M32x1.5	36	14.0	7.5	3600.21.32	25
Pg 21	M40x1.5	46	14.0	7.5	3600.21.40	20
Pg 29	M40x1.5	46	14.0	8	3600.29.40	20
Pg 29	M50x1.5	55	16.0	8	3600.29.50	10
Pg 36	M50x1.5	55	16.0	8	3600.36.50	10
Pg 36	M63x1.5	70	17.0	8	3600.36.63	10
Pg 42	M63x1.5	70	17.0	10	3600.42.63	10
Pg 42	M75x1.5	80	18.0	10	3600.42.75	10
Pg 48	M63x1.5	70	17.0	11	3600.48.63	10
Pg 48	M75x1.5	80	18.0	11	3600.48.75	10

Runde Bauform, randriert | Round, knurled

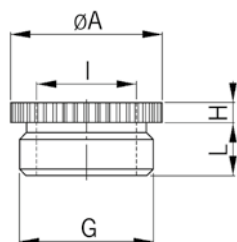

Material: Messing vernickelt
 Einsatztemperatur: -40°C / +200°C
 Schutzart: IP 54
 Weitere Schutzart: IP 68, wenn Anschlussge-
 winde abgedichtet

Material: Nickel-plated brass
 Temperature range: -40°C / +200°C
 Protection class: IP 54
 Further protection: IP 68, if the entry thread
 is sealed



Aussengewinde Pg
 Innengewinde metrisch
 ohne O-Ring

Outer thread Pg
 Inner thread metric
 without O-Ring

G	I	$\frac{\varnothing A}{mm}$	H mm	L mm	Art.-Nr. Art. No.	
Pg 11	M16x1.5	20	10	6	3545.11.17	50
Pg 16	M20x1.5	24	11	6	3545.16.20	50
Pg 21	M20x1.5	30	3.5	7.5	3545.21.20	50
Pg 21	M25x1.5	30	11	7.5	3545.21.25	50
Pg 29	M25x1.5	39	4	8	3545.29.25	25
Pg 29	M32x1.5	39	4	8	3545.29.32	25
Pg 36	M40x1.5	50	4.5	8	3545.36.40	10

Adapter Messing

Adapter nickel-plated brass

Runde Bauform | Round execution

Material: Messing vernickelt
 Einsatztemperatur: -40°C / +200°C
 Schutzart: IP 54
 Weitere Schutzart: IP 68, wenn Anschlussge-
 winde abgedichtet

Material: Nickel-plated brass
 Temperature range: -40°C / +200°C
 Protection class: IP 54
 Further protection: IP 68, if the entry thread
 is sealed

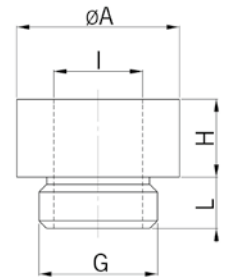

Aussengewinde Pg
 Innengewinde metrisch
 ohne O-Ring

Outer thread Pg
 Inner thread metric
 without O-Ring

G	I	øA mm	H mm	L mm	Art.-Nr. Art. No.	
Pg 7	M12x1.5	14	9	6	3645.07.12	100
Pg 9	M16x1.5	19	9.5	6	3645.09.17	50
Pg 11	M20x1.5	22	11	6	3645.11.20	50
Pg 13	M20x1.5	22	11	6	3645.13.20	50
Pg 16	M25x1.5	27	11	6	3645.16.25	50
Pg 21	M32x1.5	34	12	7.5	3645.21.32	50
Pg 29	M40x1.5	42	12	8	3645.29.40	10



mit 6-kant | hexagonal

Material: Messing vernickelt
 O-Ring: NBR
 Einsatztemperatur: -40°C / +100°C
 Schutzart: IP 68

Material: Nickel-plated brass
 O-ring: NBR
 Temperature range: -40°C / +100°C
 Protection class: IP 68

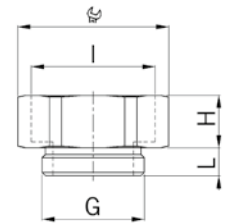

Aussengewinde Pg
 Innengewinde Gasrohr
 mit O-Ring

Outer thread Pg
 Inner thread gas-pipe
 with O-ring

G	I	 mm	H mm	L mm	Art.-Nr. Art. No.	
Pg 13	G3/8"	24	3	7	35133/8G	50
Pg 16	G1/2"	24	14	10	36161/2G.08	50
Pg 21	G3/4"	32	14	12	36213/4G.08	25
Pg 36	G 2"	64	20	12	3636.48.08	10
Pg 42	G 2"	64	20	15	3642.48.08	10



Aussengewinde Gasrohr
 Innengewinde Pg
 mit O-Ring

Outer thread gas-pipe
 Inner thread Pg
 with O-ring

G	I	 mm	H mm	L mm	Art.-Nr. Art. No.	
G3/8"	Pg 7	20	3	10	353/8G.07	50
G1/2"	Pg 9	24	3	9.5	351/2G.09	50
G3/4"	Pg 9	30	3.5	11	353/4G.09	50
G3/4"	Pg 11	30	3.5	11	353/4G.11	50
G3/4"	Pg 16	32	3.5	11	353/4G.16	50
G 1"	Pg 21	38	3.5	11	351G.21	25
G 1 1/4"	Pg 29	50	5	11	3511/4G.29	25
G 2"	Pg 36	64	5	11	352G.36	10
G 2"	Pg 42	64	5	11	352G.42	10



Adapter Messing

Adapter nickel-plated brass

mit 6-kant | hexagonal

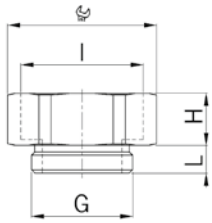

Material: Messing vernickelt
 O-Ring: NBR
 Einsatztemperatur: -40°C / +100°C
 Schutzart: IP 68

Material: Nickel-plated brass
 O-ring: NBR
 Temperature range: -40°C / +100°C
 Protection class: IP 68



Aussengewinde Gasrohr
 Gewinde innen Pg
 mit O-Ring

Outer thread gas-pipe
 Inner thread Pg
 with O-ring

G	I	mm	H	L	mm	mm	Art.-Nr. Art. No.	
G3/8"	Pg 11	20	12	10			363/8G.11.08	50
G1/2"	Pg 11	24	12	10			361/2G.11.08	50
G1/2"	Pg 13	24	12	10			361/2G.13.08	50
G1/2"	Pg 16	24	12	10			361/2G.16.08	50
G5/8"	Pg 16	24	12	10			365/8G.16.08	50
G3/4"	Pg 21	32	15	12			363/4G.21.08	25
G7/8"	Pg 29	41	15	12			367/8G.29.08	25
G 1"	Pg 29	41	15	11			361G.29.08	25
G 1 1/2"	Pg 36	54	22	12			3611/2G.36.08	10

mit 6-kant | hexagonal

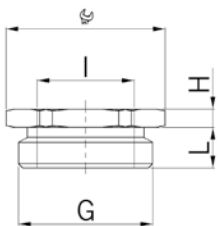

Material: Messing vernickelt
 Einsatztemperatur: -40°C / +100°C
 Schutzart: IP 68, wenn Anschlussge-
 winde abgedichtet

Material: Nickel-plated brass
 Temperature range: -40°C / +100°C
 Protection class: IP 68, if the entry thread
 is sealed



Aussengewinde NPT
 Innengewinde Pg
 ohne O-Ring

Outer thread NPT
 Inner thread Pg
 without O-Ring

G	I	mm	H	L	mm	mm	Art.-Nr. Art. No.	
NPT1/2"	Pg 9	22	4.5	20			351/2NPT.09	50
NPT3/4"	Pg 11	30	4	20			353/4NPT.11	10
NPT3/4"	Pg 13	30	4	20			353/4NPT.13	10
NPT 1"	Pg 16	36	6	26			351NPT.16	10

mit 6-kant | hexagonal

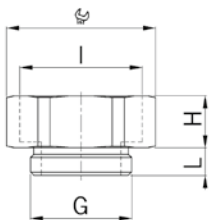

Material: Messing vernickelt
 O-Ring: NBR
 Einsatztemperatur: -40°C / +100°C
 Schutzart: IP 68, wenn Anschlussge-
 winde abgedichtet

Material: Nickel-plated brass
 O-ring: NBR
 Temperature range: -40°C / +100°C
 Protection class: IP 68, if the entry thread
 is sealed



Aussengewinde NPT
 Innengewinde Pg
 ohne O-Ring

Outer thread NPT
 Inner thread Pg
 without O-Ring

G	I	mm	H	L	mm	mm	Art.-Nr. Art. No.	
NPT1/2"	Pg 11	24	12	20			361/2NPT.11	50
NPT1/2"	Pg 13	24	14	20			361/2NPT.13	50
NPT1/2"	Pg 16	34	20	20			361/2NPT.16	50
NPT3/4"	Pg 21	32	14	20			363/4NPT.21	25

Reduktionen Kunststoff

Synthetic reduction fittings

mit 6-kant | hexagonal

Material: Polyamid PA 6
 Eigenschaften: halogenfrei
 Einsatztemperatur: -30°C / +100°C
 Schutzart: IP 54
 Weitere Schutzart: IP 68, wenn Anschlussge-
 winde abgedichtet

Material: Polyamide PA 6
 Properties: halogen-free
 Temperature range: -30°C / +100°C
 Protection class: IP 54
 Further protection: IP 68, if the entry thread
 is sealed

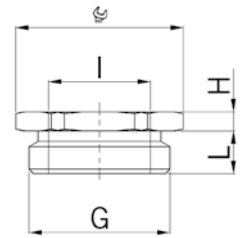

Aussengewinde metrisch
 Innengewinde metrisch
 Hellgrau RAL 7035

Outer thread metric
 Inner thread metric
 Light grey RAL 7035

G	I	$\frac{G}{mm}$	H mm	L mm	Art.-Nr. Art. No.	
M16x1.5	M12x1.5	22	4	8	3455.17.12	100
M20x1.5	M12x1.5	24	4	8	3455.20.12	100
M20x1.5	M16x1.5	24	4	8	3455.20.17	100
M25x1.5	M12x1.5	29	6	8	3455.25.12	100
M25x1.5	M16x1.5	29	6	8	3455.25.17	100
M25x1.5	M20x1.5	29	6	8	3455.25.20	100
M32x1.5	M12x1.5	36	6	10	3455.32.12	50
M32x1.5	M16x1.5	36	6	10	3455.32.17	50
M32x1.5	M20x1.5	36	6	10	3455.32.20	50
M32x1.5	M25x1.5	36	6	10	3455.32.25	50
M40x1.5	M16x1.5	46	6	10	3455.40.17	50
M40x1.5	M20x1.5	46	6	10	3455.40.20	50
M40x1.5	M25x1.5	46	6	10	3455.40.25	25
M40x1.5	M32x1.5	46	6	10	3455.40.32	25
M50x1.5	M20x1.5	55	6	12	3455.50.20	5
M50x1.5	M25x1.5	55	6	12	3455.50.25	5
M50x1.5	M32x1.5	55	6	12	3455.50.32	5
M50x1.5	M40x1.5	55	6	12	3455.50.40	5
M63x1.5	M25x1.5	68	6	12	3455.63.25	5
M63x1.5	M32x1.5	68	6	12	3455.63.32	5
M63x1.5	M40x1.5	68	6	12	3455.63.40	5
M63x1.5	M50x1.5	68	6	12	3455.63.50	5



mit 6-kant | hexagonal

Material: Polyamid glasfaserver-
 stärkt
 Einsatztemperatur: -20°C / +100°C
 Schutzart: IP 54
 Weitere Schutzart: IP 68, wenn Anschlussge-
 winde abgedichtet

Material: Polyamide glass fiber
 reinforced
 Temperature range: -20°C / +100°C
 Protection class: IP 54
 Further protection: IP 68, if the entry thread
 is sealed

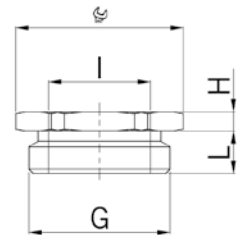

Aussengewinde Pg
 Innengewinde Pg
 Hellgrau

Outer thread Pg
 Inner thread Pg
 Light grey

G	I	$\frac{G}{mm}$	H mm	L mm	Art.-Nr. Art. No.	
Pg 9	Pg 7	19	12	8	3409.07	50
Pg 11	Pg 7	22	3	8	3411.07	50
Pg 11	Pg 9	22	15	8	3411.09	50
Pg 13	Pg 9	24	3	9	3413.09	50
Pg 13	Pg 11	24	15	9	3413.11	50
Pg 16	Pg 9	27	5	9	3416.09	50
Pg 16	Pg 11	27	5	9	3416.11	50
Pg 16	Pg 13	27	17	10	3416.13	50
Pg 21	Pg 13	32	5	11	3421.13	25
Pg 21	Pg 16	32	5	11	3421.16	25
Pg 29	Pg 21	41	6	12	3429.21	10
Pg 36	Pg 29	50	6	14	3436.29	10



Erweiterungen Kunststoff

Synthetic enlarging fittings

rund mit 6-kant | round with hexagon

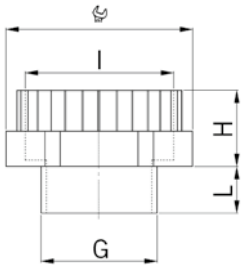

Material: Polyamid PA 6
 Eigenschaften: halogenfrei
 Einsatztemperatur: -30°C / +100°C
 Schutzart: IP 54
 Weitere Schutzart: IP 68, wenn Anschlussge-
 winde abgedichtet

Material: Polyamide PA 6
 Properties: halogen-free
 Temperature range: -30°C / +100°C
 Protection class: IP 54
 Further protection: IP 68, if the entry thread
 is sealed



Aussengewinde metrisch
 Innengewinde metrisch
 Hellgrau RAL 7035

Outer thread metric
 Inner thread metric
 Light grey RAL 7035

G	I	 mm	H mm	L mm	Art.-Nr. Art. No.	
M12x1.5	M16x1.5	20	13	8	3755.12.17	100
M16x1.5	M20x1.5	24	13	8	3755.17.20	100
M20x1.5	M25x1.5	29	13	8	3755.20.25	100
M25x1.5	M32x1.5	36	15	8	3755.25.32	50
M32x1.5	M40x1.5	46	15	10	3755.32.40	25
M40x1.5	M50x1.5	55	15	10	3755.40.50	10
M50x1.5	M63x1.5	68	15	10	3755.50.63	10

rund mit 6-kant | round with hexagon

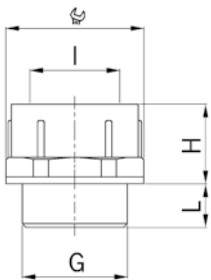

Material: Polyamid glasfaserver-
 stärkt
 Einsatztemperatur: -20°C / +100°C
 Schutzart: IP 54, IP 68 wenn An-
 schlussgewinde abge-
 dichtet

Material: Polyamide glass fiber
 reinforced
 Temperature range: -20°C / +100°C
 Protection class: IP 54, IP 68 if the thread
 is sealed



Aussengewinde Pg
 Innengewinde Pg
 Hellgrau

Outer thread Pg
 Inner thread Pg
 Light grey

G	I	 mm	H mm	L mm	Art.-Nr. Art. No.	
Pg 7	Pg 9	19	18	7	3707.09	50
Pg 9	Pg 11	22	19	7	3709.11	50
Pg 11	Pg 13	24	21	8	3711.13	50
Pg 13	Pg 16	27	23	9	3713.16	50
Pg 16	Pg 21	32	26	9	3716.21	25
Pg 21	Pg 29	41	33	10	3721.29	25
Pg 29	Pg 36	55	39	12	3729.36	10
Pg 36	Pg 42	60	46	14	3736.42	10
Pg 42	Pg 48	65	39	16	3742.48	10

rund mit 6-kant | round with hexagon

Material: Polyamid glasfaserverstärkt
 Einsatztemperatur: -20°C / +100°C
 Schutzart: IP 54
 Weitere Schutzart: IP 68, wenn Anschlussgewinde abgedichtet

Material: Polyamide glass fiber reinforced
 Temperature range: -20°C / +100°C
 Protection class: IP 54
 Further protection: IP 68, if the entry thread is sealed

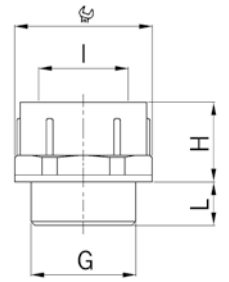

Aussengewinde metrisch Innengewinde Pg Hellgrau					Outer thread metric Inner thread Pg Light grey		Art.-Nr. Art. No.	
G	I		H mm	L mm				
M12x1.5	Pg 9	19	13	11		3712.09	50	
M20x1.5	Pg 13	24	15	11		3720.13	50	
M20x1.5	Pg 16	27	17	11		3720.16	50	
M25x1.5	Pg 21	33	20	11		3725.21	25	
M32x1.5	Pg 29	42	22	11		3732.29	25	
M50x1.5	Pg 42	60	28	11		3750.42	10	



Aussengewinde metrisch Innengewinde Pg Hellgrau					Outer thread metric Inner thread Pg Light grey		Art.-Nr. Art. No.	
G	I		H mm	L mm				
M16x1.5	Pg 9	19	14	11		3417.09	50	
M20x1.5	Pg 11	22	16	11		3420.11	50	
M25x1.5	Pg 16	27	18	11		3425.16	50	
M40x1.5	Pg 29	42	23	11		3440.29	25	
M50x1.5	Pg 36	53	26	11		3450.36	10	
M63x1.5	Pg 48	65	29	11		3463.48	5	



1
2
3
4
5
6
7
8
9
10
11
12

Adapter Kunststoff

Synthetic adapter

rund mit 6-kant | round with hexagon

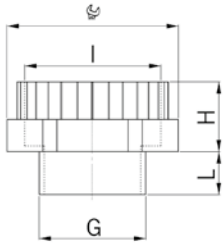

Material: Polyamid PA 6
 Eigenschaften: halogenfrei
 Einsatztemperatur: -30°C / +100°C
 Schutzart: IP 54
 Weitere Schutzart: IP 68, wenn Anschlussge-
 winde abgedichtet

Material: Polyamide PA 6
 Properties: halogen-free
 Temperature range: -30°C / +100°C
 Protection class: IP 54
 Further protection: IP 68, if the entry thread
 is sealed



Aussengewinde Pg
 Innengewinde metrisch
 Hellgrau RAL 7035

Outer thread Pg
 Inner thread metric
 Light grey RAL 7035

G	I	 mm	H mm	L mm	Art.-Nr. Art. No.	
Pg 7	M12x1.5	15	12	8	3755.07.12	100
Pg 7	M16x1.5	20	12	8	3755.07.17	100
Pg 9	M16x1.5	20	12	8	3755.09.17	100
Pg 9	M20x1.5	24	12	8	3755.09.20	100
Pg 11	M20x1.5	24	12	8	3755.11.20	100
Pg 13	M25x1.5	30	13	9	3755.13.25	100
Pg 16	M25x1.5	30	13	10	3755.16.25	50
Pg 21	M32x1.5	37	14	11	3755.21.32	50
Pg 29	M40x1.5	45	14	11	3755.29.40	50
Pg 42	M50x1.5	55	17	11	3755.42.50	10
Pg 48	M63x1.5	68	17	11	3755.48.63	5



Aussengewinde Pg
 Innengewinde metrisch
 Hellgrau RAL 7035

Outer thread Pg
 Inner thread metric
 Light grey RAL 7035

G	I	 mm	H mm	L mm	Art.-Nr. Art. No.	
Pg 9	M12x1.5	19	12	8	3455.09.12	100
Pg 11	M16x1.5	22	12	8	3455.11.17	100
Pg 13	M16x1.5	24	13	9	3455.13.17	100
Pg 13	M20x1.5	24	13	9	3455.13.20	100
Pg 16	M20x1.5	27	13	10	3455.16.20	50
Pg 21	M25x1.5	33	14	11	3455.21.25	50
Pg 29	M32x1.5	42	14	11	3455.29.32	50
Pg 36	M40x1.5	55	14	11	3455.36.40	25

Verschlusschrauben Messing

Locking plugs nickel-plated brass

Kurzes Anschlussgewinde metrisch | Short entry thread metric

Material: Messing vernickelt
 O-Ring: NBR
 Einsatztemperatur: -40°C / +100°C
 Schutzart: IP 68

Material: Nickel-plated brass
 O-ring: NBR
 Temperature range: -40°C / +100°C
 Protection class: IP 68

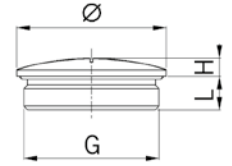

Runde Bauform mit O-Ring					Round execution with O-ring	
G	Ø mm	H mm	L mm	i info	Art.-Nr. Art. No.	
M6x1.0	9	3	5	1	8706.08	50
M8x1.25	10	3	5	1	8708.08	50
M10x1.5	12	3	5	1	8710.08	50
M12x1.5	14	3	5	-	8712.08	50
M16x1.5	19	3	5	-	8717.08	50
M20x1.5	24	3	6	-	8720.08	25
M25x1.5	28	4	7	-	8725.08	25
M32x1.5	35	4	8	-	8732.08	10
M40x1.5	45	6	8	-	8740.08	10
M50x1.5	55	6	9	-	8750.08	10
M63x1.5	70	6	10	-	8763.08	10
M75x1.5	80	6	11	-	8775.08	5

1 = Metrisches Regelgewinde 1 = Metric coarse-pitch thread



Langes Anschlussgewinde metrisch | Long entry thread metric

Material: Messing vernickelt
 O-Ring: NBR
 Einsatztemperatur: -40°C / +100°C
 Schutzart: IP 68

Material: Nickel-plated brass
 O-ring: NBR
 Temperature range: -40°C / +100°C
 Protection class: IP 68

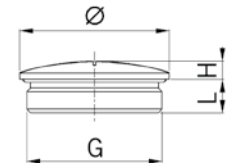

Runde Bauform mit O-Ring					Round execution with O-ring	
G	Ø mm	H mm	L mm	i info	Art.-Nr. Art. No.	
M6x1.0	9	3	8	1	8706.11.08	50
M8x1.25	10	3	10	1	8708.11.08	50
M10x1.5	12	3	10	1	8710.11.08	50
M12x1.5	14	3	10	-	8712.11.08	50
M16x1.5	19	3	10	-	8717.11.08	50
M20x1.5	24	3	10	-	8720.11.08	25
M25x1.5	28	4	11	-	8725.11.08	25
M32x1.5	35	4	13	-	8732.11.08	10
M40x1.5	45	6	13	-	8740.11.08	10
M50x1.5	55	6	14	-	8750.11.08	10
M63x1.5	70	6	15	-	8763.11.08	10
M75x1.5	80	6	15	-	8775.11.08	5

1 = Metrisches Regelgewinde 1 = Metric coarse-pitch thread



Verschlusschrauben Messing

Locking plugs nickel-plated brass

Kurzes Anschlussgewinde metrisch | Short entry thread metric

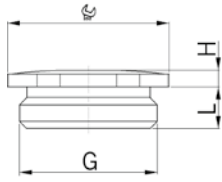

Material: Messing vernickelt
 Einsatztemperatur: -40°C / +200°C
 Schutzart: IP 54
 Weitere Schutzart: IP 68, wenn Anschlussgewinde abgedichtet

Material: Nickel-plated brass
 Temperature range: -40°C / +200°C
 Protection class: IP 54
 Further protection: IP 68, if the entry thread is sealed



6-kant
ohne O-Ring

Hexagonal design
without O-Ring

G	 mm	H mm	L mm	Art.-Nr. Art. No.	
M12x1.5	14	2.5	5	8745.12	100
M16x1.5	18	2.5	5	8745.17	100
M20x1.5	22	2.5	6	8745.20	100
M25x1.5	27	3.0	7	8745.25	50
M32x1.5	34	3.5	8	8745.32	25
M40x1.5	42	4.0	8	8745.40	25
M50x1.5	52	4.0	9	8745.50	10
M63x1.5	65	4.0	10	8745.63	10

Kurzes Anschlussgewinde Pg | Short entry thread Pg

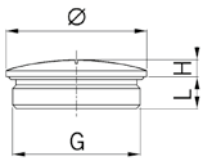

Material: Messing vernickelt
 O-Ring: NBR
 Einsatztemperatur: -40°C / +100°C
 Schutzart: IP 68

Material: Nickel-plated brass
 O-ring: NBR
 Temperature range: -40°C / +100°C
 Protection class: IP 68



Runde Bauform
mit O-Ring

Round execution
with O-ring

G	Ø mm	H mm	L mm	Art.-Nr. Art. No.	
Pg 7	14	3	5	8707.08	100
Pg 9	17	3	6	8709.08	100
Pg 11	20	3	6	8711.08	100
Pg 13	22	3	6.5	8713.08	50
Pg 16	24	3	6.5	8716.08	50
Pg 21	30	4	7	8721.08	10
Pg 29	39	4	8	8729.08	10
Pg 36	50	6	9	8736.08	10
Pg 42	60	6	10	8742.08	10
Pg 48	65	6	10	8748.48.08	10
G 2"	65	6	10	8748.08	10

Langes Anschlussgewinde Pg | Long entry thread Pg



Runde Bauform
mit O-Ring

Round execution
with O-ring

G	Ø mm	H mm	L mm	Art.-Nr. Art. No.	
Pg 7	14	3	10	8707.11.08	100
Pg 9	17	3	10	8709.11.08	100
Pg 11	20	3	10	8711.11.08	100
Pg 13	22	3	10	8713.11.08	50
Pg 16	24	3	10	8716.11.08	50
Pg 21	30	4	12	8721.11.08	10
Pg 29	39	4	12	8729.11.08	10
Pg 36	50	6	15	8736.11.08	10

Verschlusschrauben rostfreier Stahl A2

Locking plugs stainless steel A2

Runde Bauform | Round execution

Material: Rostfreier CrNi-Stahl A2
(DIN EN 1.4305 / AISI 303)
O-Ring: NBR
Einsatztemperatur: -40°C / +100°C
Schutzart: IP 68

Material: CrNi stainless steel A2
(DIN EN 1.4305 / AISI 303)
O-ring: NBR
Temperature range: -40°C / +100°C
Protection class: IP 68

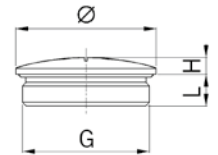

Kurzes Anschlussgewinde metrisch
mit O-Ring

Short entry thread metric
with O-ring

G	Ø mm	H mm	L mm	i info	Art.-Nr. Art. No.	
M10x1.5	12	3	5	1	8710.96.08.70	50
M12x1.5	14	3	5	-	8712.96.08.70	50
M16x1.5	19	3	5	-	8717.96.08.70	50
M20x1.5	24	3	6	-	8720.96.08.70	25
M25x1.5	28	4	7	-	8725.96.08.70	25
M32x1.5	35	4	8	-	8732.96.08.70	10
M40x1.5	45	6	8	-	8740.96.08.70	10
M50x1.5	55	6	9	-	8750.96.08.70	10
M63x1.5	70	6	10	-	8763.96.08.70	10
M75x1.5	80	6	11	-	8775.96.08.70	5

1 = Metrisches Regelgewinde

1 = Metric coarse-pitch thread

Auf Anfrage lieferbar:

Available on request:

Anschlussgewinde Pg

Entry thread Pg



Langes Anschlussgewinde metrisch
mit O-Ring

Long entry thread metric
with O-ring

G	Ø mm	H mm	L mm	i info	Art.-Nr. Art. No.	
M10x1.5	12	3	10	1	8710.96.11.08.70	50
M12x1.5	14	3	10	-	8712.96.11.08.70	50
M16x1.5	19	3	10	-	8717.96.11.08.70	50
M20x1.5	24	3	10	-	8720.96.11.08.70	25
M25x1.5	28	4	11	-	8725.96.11.08.70	25
M32x1.5	35	4	13	-	8732.96.11.08.70	10
M40x1.5	45	6	13	-	8740.96.11.08.70	10
M50x1.5	55	6	14	-	8750.96.11.08.70	10
M63x1.5	70	6	15	-	8763.96.11.08.70	10
M75x1.5	80	6	15	-	8775.96.11.08.70	5

1 = Metrisches Regelgewinde

1 = Metric coarse-pitch thread

Auf Anfrage lieferbar:

Available on request:

Anschlussgewinde Pg

Entry thread Pg



1
2
3
4
5
6
7
8
9
10
11
12

Verschlusschrauben rostfreier Stahl A2

Locking plugs stainless steel A2

Runde Bauform | Round execution

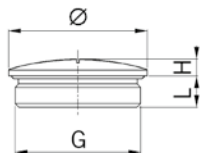

Verschlusschrauben rostfreier Stahl A2 für hohe Temperaturen

Material: Rostfreier CrNi-Stahl A2 (DIN EN 1.4305 / AISI 303)
 O-Ring: FPM
 Einsatztemperatur: -40°C / +200°C
 Schutzart: IP 68

Locking plugs stainless steel A2 for high temperature applications

Material: CrNi stainless steel A2 (DIN EN 1.4305 / AISI 303)
 O-ring: FPM
 Temperature range: -40°C / +200°C
 Protection class: IP 68



Kurzes Anschlussgewinde metrisch mit O-Ring

Short entry thread metric with O-ring

G	Ø mm	H mm	L mm	i info	Art.-Nr. Art. No.	
M10x1.5	12	3	5	1	8710.96.08	50
M12x1.5	14	3	5	-	8712.96.08	50
M16x1.5	19	3	5	-	8717.96.08	50
M20x1.5	24	3	6	-	8720.96.08	25
M25x1.5	28	4	7	-	8725.96.08	25
M32x1.5	35	4	8	-	8732.96.08	10
M40x1.5	45	6	8	-	8740.96.08	10
M50x1.5	55	6	9	-	8750.96.08	10
M63x1.5	70	6	10	-	8763.96.08	10
M75x1.5	80	6	11	-	8775.96.08	5

1 = Metrisches Regelgewinde
 Auf Anfrage lieferbar:
 Anschlussgewinde Pg

1 = Metric coarse-pitch thread
 Available on request:
 Entry thread Pg



Langes Anschlussgewinde metrisch mit O-Ring

Long entry thread metric with O-ring

G	Ø mm	H mm	L mm	i info	Art.-Nr. Art. No.	
M10x1.5	12	3	10	1	8710.96.11.08	50
M12x1.5	14	3	10	-	8712.96.11.08	50
M16x1.5	19	3	10	-	8717.96.11.08	50
M20x1.5	24	3	10	-	8720.96.11.08	25
M25x1.5	28	4	11	-	8725.96.11.08	25
M32x1.5	35	4	13	-	8732.96.11.08	10
M40x1.5	45	6	13	-	8740.96.11.08	10
M50x1.5	55	6	14	-	8750.96.11.08	10
M63x1.5	70	6	15	-	8763.96.11.08	10
M75x1.5	80	6	15	-	8775.96.11.08	5

1 = Metrisches Regelgewinde
 Auf Anfrage lieferbar:
 Anschlussgewinde Pg

1 = Metric coarse-pitch thread
 Available on request:
 Entry thread Pg

Verschlusschrauben Kunststoff

Synthetic locking plugs

Gewinde metrisch | Metric thread

Material: Polyamid PA 6
 Einsatztemperatur: -30°C / +100°C
 Schutzart: IP 54
 Weitere Schutzart: IP 68, wenn Anschlussgewinde abgedichtet

Material: Polyamide PA 6
 Temperature range: -30°C / +100°C
 Protection class: IP 54
 Further protection: IP 68, if the entry thread is sealed

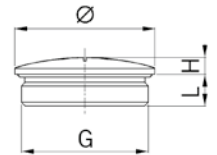

Hellgrau RAL 7035 ohne O-Ring				Light grey RAL 7035 without O-Ring	
G	Ø mm	H mm	L mm	Art.-Nr. Art. No.	
M12x1.5	15	4.5	6	8855.12	100
M16x1.5	20	4.5	6	8855.17	100
M20x1.5	24	4.5	6	8855.20	100
M25x1.5	30	5.0	8	8855.25	100
M32x1.5	37	5.5	8	8855.32	50
M40x1.5	46	6.0	8	8855.40	50
M50x1.5	56	6.0	10	8855.50	10
M63x1.5	70	6.0	12	8855.63	10



Schwarz RAL 9005 ohne O-Ring				Black RAL 9005 without O-Ring	
G	Ø mm	H mm	L mm	Art.-Nr. Art. No.	
M12x1.5	15	4.5	6	8845.12	100
M16x1.5	20	4.5	6	8845.17	100
M20x1.5	24	4.5	6	8845.20	100
M25x1.5	30	5.0	8	8845.25	100
M32x1.5	37	5.5	8	8845.32	50
M40x1.5	46	6.0	8	8845.40	50
M50x1.5	56	6.0	10	8845.50	10
M63x1.5	70	6.0	12	8845.63	10



Anschlussgewinde Pg | Entry thread Pg

Material: schlagfestes Material: Polypropylen
 Einsatztemperatur: -20°C / +80°C
 Schutzart: IP 54, IP 68 wenn Anschlussgewinde abgedichtet

Material: Shock-resistant polystyrene
 Temperature range: -20°C / +80°C
 Protection class: IP 54, IP 68 if the thread is sealed

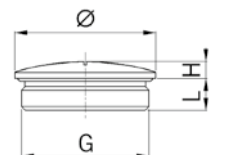

Hellgrau RAL 7035 ohne O-Ring				Light grey RAL 7035 without O-Ring	
G	Ø mm	H mm	L mm	Art.-Nr. Art. No.	
Pg 7	15	2.0	6.0	8807	100
Pg 9	19	3.0	6.5	8809	100
Pg 11	22	3.5	6.5	8811	100
Pg 13	25	3.5	6.5	8813	100
Pg 16	27	3.5	6.5	8816	100
Pg 21	33	4.0	8.0	8821	100
Pg 29	44	4.0	8.0	8829	50
Pg 36	55	4.0	10.0	8836	25
Pg 42	62	6.0	10.0	8842	10
Pg 48	69	5.0	12.0	8848.48	25



Dichteinsätze Vollgummi

Solid rubber sealing inserts

passend zu Kabelverschraubungen Progress® | suitable for cable glands Progress®



Material: NBR
Einsatztemperatur: -40°C / +100°C

Material: NBR
Temperature range: -40°C / +100°C



Kurzer Dichteinsatz ohne Bohrung

Short sealing insert without drilled hole

G	 mm	Art.-Nr. Art. No.	
M6	3.5	1000.06.30.03	1
M8	5.0	1000.08.30.03	1
M10	6.0	1000.10.30.03	1
Pg 11	12.0	1000.11.30.03	1
M12 / Pg 7	8.0	1000.12.30.03	1
M16 / Pg 9	10.5	1000.17.30.03	1
M20 / Pg 13 / Pg 16	15.0	1000.20.30.03	1
M25 / Pg 21	20.5	1000.25.30.03	1
Pg 29	27.5	1000.29.30.03	1
M32	25.5	1000.32.30.03	1
Pg 36	35.0	1000.36.30.03	1
M40	33.0	1000.40.30.03	1
Pg 48	49.0	1000.48.30.03	1
M50 / Pg 42	42.0	1000.50.30.03	1
M63	52.0	1000.63.30.03	1
M75	63.0	1000.75.30.03	1
M85	70.0	1000.85.30.03	1
M95	80.0	1000.95.30.03	1
M100	85.0	1000.100.30.03	1
M105	90.0	1000.105.30.03	1
M115	95.0	1000.115.30.03	1

Technischer Hinweis

Technical note

Dichteinsätze ohne Bohrung lassen sich gut bearbeiten, wenn sie vorher auf mindestens -25°C gefroren wurden.

When frozen to at least -25°C, the solid sealing inserts are easy to drill.

passend zu Kabelverschraubungen Progress® | suitable for cable glands Progress®

Dichteinsätze Vollgummi für hohe Temperaturen

Solid rubber sealing inserts for high- temperatures applications

Material: FPM
Einsatztemperatur: -40°C / +200°C

Material: FPM
Temperature range: -40°C / +200°C



Kurzer Dichteinsatz ohne Bohrung

Short sealing insert without drilled hole

G	 mm	Art.-Nr. Art. No.	
M6	3.5	1000.06.98.30.03	1
M8	5.0	1000.08.98.30.03	1
M10	6.0	1000.10.98.30.03	1
Pg 11	12.0	1000.11.98.30.03	1
M12 / Pg 7	8.0	1000.12.98.30.03	1
M16 / Pg 9	10.5	1000.17.98.30.03	1
M20 / Pg 16	15.0	1000.20.98.30.03	1
M25 / Pg 21	20.5	1000.25.98.30.03	1
Pg 29	27.5	1000.29.98.30.03	1
M32	25.5	1000.32.98.30.03	1
Pg 36	35.0	1000.36.98.30.03	1
M40 / Pg 29	33.0	1000.40.98.30.03	1
Pg 48	49.0	1000.48.98.30.03	1
M50 / Pg 42	42.0	1000.50.98.30.03	1
M63	52.0	1000.63.98.30.03	1

Technischer Hinweis

Technical note

Dichteinsätze ohne Bohrung lassen sich gut bearbeiten, wenn sie vorher auf mindestens -25°C gefroren wurden.

When frozen to at least -25°C, the solid sealing inserts are easy to drill.

passend zu Kabelverschraubungen Progress® | suitable for cable glands Progress®

Material: NBR
Einsatztemperatur: -40°C / +100°C

Material: NBR
Temperature range: -40°C / +100°C

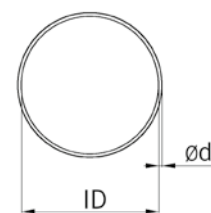

zu Anschlussgewinde metrisch oder Pg			suitable for entry thread metric or Pg	
G	Øl mm	ød mm	Art.-Nr. Art. No.	
M 6	5.0	1.0	1005.00.08	1
M 8	6.0	1.5	1006.00.08	1
M10	8.1	1.6	1006.06.08	1
M12 / Pg 7	10.0	1.5	1007.00.08	1
M16 / Pg 9	13.1	1.6	1000.09.00.08	1
M20	17.0	2.0	2111.00.08	1
M25	22.0	2.0	1013.00.22.08	1
M32	30.0	2.0	1021.00.30.08	1
M40	36.0	2.0	1000.40.00.08	1
M50	46.0	2.0	1000.50.00.08	1
M63	60.0	2.0	1000.63.00.08	1
M75	72.0	2.0	1000.75.00.08	1
Pg 11	15.0	2.0	1011.00.08	1
Pg 13 / Pg 16	19.0	2.0	1016.00.08	1
Pg 21	25.0	2.0	1016.00.25.08	1
Pg 29	33.0	2.2	1029.00.08	1
Pg 36	42.5	2.6	1036.00.08	1
Pg 42	48.0	3.0	1000.42.00.08	1
Pg 48	55.0	2.0	1000.48.00.08	1



passend zu Kabelverschraubungen Progress® | suitable for cable glands Progress®

O-Ringe für hohe Temperaturen

O-rings for high temperatures

Material: FPM
Einsatztemperatur: -40°C / +200°C

Material: FPM
Temperature range: -40°C / +200°C

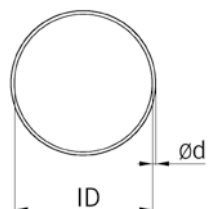

zu Anschlussgewinde metrisch oder Pg			suitable for entry thread metric or Pg	
G	Øl mm	ød mm	Art.-Nr. Art. No.	
M 6	5.0	1.0	1105.98.08	1
M 8	6.0	1.8	1106.98.08	1
M10	8.1	1.6	1106.06.98.08	1
M12 / Pg 7	10.0	1.5	1107.98.08	1
M16 / Pg 9	13.1	1.6	1100.09.98.08	1
M20	17.0	2.0	2111.98.08	1
M25	22.0	2.0	1113.98.22.08	1
M32	30.0	2.0	1121.98.30.08	1
M40	36.0	2.0	1100.40.98.08	1
M50	46.0	2.0	1100.50.98.08	1
M63	60.0	2.0	1100.63.98.08	1
M75	72.0	2.0	1100.75.98.08	1
Pg 11	15.0	2.0	1111.98.08	1
Pg 13 / Pg 16	18.0	2.0	1116.98.08	1
Pg 21	25.0	2.0	1116.98.25.08	1
Pg 29	33.0	1.8	1129.98.08	1
Pg 36	42.5	2.6	1136.98.08	1
Pg 42	48.0	3.0	1100.42.98.08	1
Pg 48	55.0	2.0	1100.48.98.08	1



Dichtungsscheiben

Sealing washers

passend zu Kabelverschraubungen Progress® | suitable for cable glands Progress®

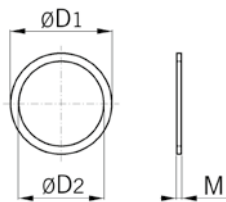

Material: KlingerSIL C-4300
 Einsatztemperatur: -40°C / +300°C
 Farbe: Grün

Material: KlingerSIL C-4300
 Temperature range: -40°C / +300°C
 Colour: Green



zu Anschlussgewinde metrisch

suitable for metric entry thread

G	ØD1 mm	ØD2 mm	M mm	Art.-Nr. Art. No.	
M6	10.0	6.0	1.5	1006.00.16	50
M8	12.0	8.0	1.5	1008.00.16	50
M10	14.0	10.0	1.5	1010.00.16	50
M12	16.0	12.0	1.5	1012.00.16	50
M16	21.0	16.0	1.5	1017.00.16	50
M20 / Pg 13	25.0	20.5	1.5	1013.00.16	50
M25	31.0	25.0	2.0	1025.00.16	50
M32	39.0	32.0	2.0	1032.00.16	50
M40	48.0	40.0	2.0	1040.00.16	50
M50	59.0	50.0	2.0	1050.00.16	50
M63	73.0	63.0	2.0	1063.00.16	50



zu Anschlussgewinde Pg

suitable for entry thread Pg

G	ØD1 mm	ØD2 mm	M mm	Art.-Nr. Art. No.	
Pg 7	16.5	12.5	1.5	1007.00.16	50
Pg 9	19.0	15.2	1.5	1009.00.16	50
Pg 11	22.5	18.5	1.5	1011.00.16	50
M20 / Pg 13	25.0	20.5	1.5	1013.00.16	50
Pg 16	27.0	22.5	1.5	1016.00.16	50
Pg 21	33.5	28.5	2.0	1021.00.16	50
Pg 29	43.5	37.0	2.0	1029.00.16	50
Pg 36	55.0	47.0	2.0	1036.00.16	50
Pg 42	63.0	54.0	2.0	1042.00.16	50
Pg 48	69.0	59.3	2.0	1048.00.16	50

passend zu Kabelverschraubungen Syntec® Messing | suitable for cable glands Syntec® nickel-plated brass

Material: Perbunan
Einsatztemperatur: -20°C / +100°C

Material: Perbunan
Temperature range: -20°C / +100°C

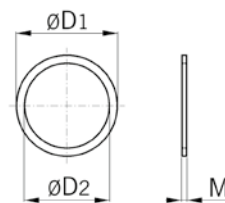

zu Anschlussgewinde metrisch

suitable for metric entry thread

G	ØD1 mm	ØD2 mm	M mm	Art.-Nr. Art. No.	
M12	20	12	1.6	1012.45.16	50
M16	23	16	1.8	1017.45.16	50
M20	29	20	1.8	1020.45.16	50
M25	37	25	1.8	1025.45.16	50
M32	44	32	2.2	1032.45.16	25
M40	52	40	2.2	1040.45.16	25
M50	64	50	2.7	1050.45.16	25
M63	68	63	3.2	1063.45.16	10



zu Anschlussgewinde Pg

suitable for entry thread Pg

G	ØD1 mm	ØD2 mm	M mm	Art.-Nr. Art. No.	
Pg 7	16.0	11.5	2.0	1007.45.16	50
Pg 9	19.0	14.0	2.0	1009.45.16	50
Pg 11	22.5	18.5	2.0	1011.45.16	50
Pg 13	25.0	19.0	2.0	1013.45.16	50
Pg 16	27.0	21.0	2.0	1016.45.16	50
Pg 21	34.0	27.0	2.5	1021.45.16	25
Pg 29	43.0	35.0	2.5	1029.45.16	25
Pg 36	54.0	45.0	2.5	1036.45.16	25





Einschnittringe NBR passend zu Stopfbuchsen B 107- B 263

Sealing rings NBR suitable for cable gland B 107 - B 263

Material: NBR
Einsatztemperatur: -20°C / +100°C
Einsatzbereich: Passend zu Stopfbuchsen B107 - B263

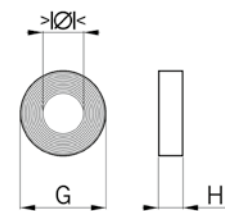
Material: NBR
Temperature range: -20°C / +100°C
Application: Suitable for cable glands series B107 - B263



G	>Ø1< min mm	>Ø2< max mm	H mm	Art.-Nr. Art. No.	
M12 / Pg 7	6.0	8.0	5.0	B 107.00.03	50
M16 / Pg 9	4.0	11.0	5.5	B 109.00.03	50
Pg 11	6.5	12.0	6.0	B 111.00.03	50
Pg 13	6.5	13.5	6.0	B 113.00.03	50
M20 / Pg 16	6.5	16.0	7.0	B 116.00.03	50
M25 / Pg 21	9.0	20.0	8.0	B 121.00.03	50
M32 / Pg 29	17.0	28.0	9.5	B 129.00.03	50
M40 / Pg 36	23.0	34.0	12.0	B 136.00.03	50
M50 / Pg 42	29.0	40.0	14.0	B 142.00.03	10
M63 / Pg 48	35.0	46.0	14.0	B 148.00.03	10



Blindscheiben und Verschlussbolzen

Blind discs and locking pins

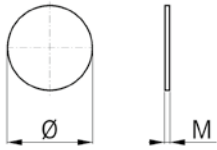

Blindscheiben passend zu Kabelverschraubungen

Material: Polyamid
 Einsatztemperatur: -20°C / +100°C
 Einsatzbereich: Staubverschluss zu Kabelverschraubungen

Blind discs suitable for cable glands

Material: Polyamide
 Temperature range: -20°C / +100°C
 Application: Dust stopper for cable glands



Blindscheibe als Staubschutz

Blind disc for dust protection

G	Ø mm	M mm		Art.-Nr. Art. No.	
M10 / M12 / Pg 7	10.5	0.3		1012.00.19	50
M16 / Pg 9	13.5	0.3		1017.00.19	50
M20 / Pg 11	16.5	0.3		1011.00.19	50
Pg 13 / Pg 16	20.5	0.3	für Syntec M25 / for Syntec M25	1020.00.19	50
M25 / Pg 21	26.5	0.3		1025.00.19	50
Pg 29	35.0	0.3		1029.00.19	50
M32	30.0	0.3		1032.00.19	50
Pg 36	45.0	0.3	für Syntec M50 / for Syntec M50	1036.00.19	50
M40	38.0	0.3		1040.00.19	50
M50 / Pg 42	52.0	0.3		1050.00.19	50
M63 / Pg 48	57.0	0.3		1063.00.19	50

Verschlussbolzen aus Kunststoff zu Mehrfach-Kabelverschraubungen

Material: Polyamid PA 6
 Einsatztemperatur: -30°C / +100°C
 Einsatzbereich: Zum Verschiessen nicht belegter Bohrungen in Mehrfach-Kabelverschraubungen

Synthetic locking pins for multi-duct cable glands

Material: Polyamide PA 6
 Temperature range: -30°C / +100°C
 Application: Usable as inserts to close unused holes in sealings of multi-duct cable glands



Verschlussbolzen zu Kabelverschraubungen

Locking pins for cable glands

>Ø< mm	L mm		Art.-Nr. Art. No.	
2	12		1310.020.07	50
3	14		1310.030.07	50
4	14		1310.040.07	50
5	14		1310.050.07	50
6	14		1310.060.07	50
7	14		1310.070.07	50
8	14		1310.080.07	50
9	14		1310.090.07	50
10	14		1310.100.07	50
11	14		1310.110.07	50
12	14		1310.120.07	50

Spezialwerkzeug für Kabelverschraubungen

Special tool for cable glands

Für Kabelverschraubungen | For cable glands

Einsatzbereich: Montagewerkzeug für Kabelverschraubungen bei engsten Platzverhältnissen

Application:

Assembly tool for cable glands in restricted spaces

Eigenschaften: Nur 2 Werkzeuge für Schlüsselweiten von 11 bis 36 mm notwendig, Zeitersparnis durch Ratschenfunktion

Properties:

Only 2 tools necessary for wrench sizes from 11 to 36 mm, time-saving due to the ratchet function

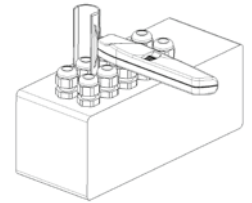

verstellbare Schlüsselweiten
bei geringem Platzbedarf

adjustable wrench sizes
for restricted spaces

 1 mm	 2 mm	L mm	B mm	Art.-Nr. Art. No.	
11	24	190	60	4800.24	1
24	36	204	60	4800.36	1



1
2
3
4
5
6
7
8
9
10
11
12

11

AGROflex Geflechschläuche in Polyester und Polyamid

AGROflex braided sleeveings made of polyester and polyamide



In Zusammenarbeit mit namhaften Kunden haben wir die Produkteigenschaften erarbeitet, welche für den Anwender besonders wichtig sind und versucht, diese Kriterien zusammen mit Produktionstechnikern in verbesserte Produkte umzusetzen.

Die bemerkenswerteste Änderung ist der spitzere Flechtwinkel, in welchem die Einzelfäden miteinander verwoben sind. Diese neue Flechtweise kombiniert mit einem etwas dünneren Monofil bei der Ausführung in Polyester führt zu einem extrem flexiblen Schlauch und zu einer hervorragenden Aufstauchbarkeit. Die Geflechte lassen sich auf das Doppelte ihrer Nennweite aufstauchen.

Der spitzere Flechtwinkel erlaubt ein geschmeidigeres Einführen von Leitungen und Kabeln auch über grössere Längen. Die Einzelfilamente laufen sozusagen parallel zu den Kabeln und stellen sich ihnen nicht als Hindernis oder „Einfädelstelle“ in den Weg.

Wichtigste Eigenschaften

- Hochflexibel
- Aufstauchverhältnis 1 : 2
- Gute Laugen- und Säurenbeständigkeit
- Geprüft nach EN 45545-2 Hazard Level 3

In cooperation with renowned customers, we have defined the product properties which are especially important for the user and have tried together with production technicians to translate these criteria into improved products.

The most notable change is the more pointed braid angle in which the individual threads are interwoven. This new way of braiding, combined with a slightly thinner monofilament in the polyester version results in an extremely flexible tube and in outstanding tubefitting qualities. The meshwork can be fitted on to areas twice as large as its nominal width.

The more pointed braid angle permits smoother insertion of cords and cables even across long distances. The individual filaments run virtually parallel to the cables and do not get in their way as an obstruction or "catching area".

Key properties

- Extremely flexible
- Expansion ratio 1 : 2
- High resistance to acids and alkaline substances
- Tested according to EN 45545-2 Hazard Level 3

AGRO Geflechschläuche Kunststoff

AGRO synthetic braided cable sleeving

AGROflex PET Geflechschläuche Polyester

AGROflex PET braided sleeves polyester

Material: Polyester PET
 Monofil: Ø 0.22mm
 Eigenschaften: Hochflexibel, selbstanpassend, abriebfest, frei von Cadmium, Formaldehyd, Halogen und Graphit, selbstverlöschend nach DIN 75200 (FMVSS 302), gute Beständigkeit gegen Kraftstoffe, Mineralöle und viele weitere Chemikalien
 Aufweitung: Aufstauchverhältnis 1 : 2
 Zulassung: EN 45545-2 (HL3)
 Einsatztemperatur: -50°C / +150°C

Material: Polyester PET
 Monofil: Ø 0.22mm
 Properties: Highly flexible, self-adapting, resistant to abrasion, free of cadmium, formaldehyde, halogen and graphite, self-extinguishing acc. to DIN 75200 (FMVSS 302), good resistance to fuel, mineral oil and many other chemicals
 Expansion: Expansion ratio 1 : 2
 Approval: EN 45545-2 (HL3)
 Temperature range: -50°C / +150°C

EN 45545-2
HL 3

Polyester PET Schwarz matt				Polyester PET Black matt	
NW	Ø min mm	Ø max mm	OFB %	Art.-Nr. Art. No.	
3	3	6	86	6875.40.03	200
4	4	8	85	6875.40.04	200
5	3	10	89	6875.40.05	200
8	6	14	81	6875.40.08	150
10	8	20	79	6875.40.10	150
15	13	25	81	6875.40.15	100
20	15	30	77	6875.40.20	100
24	24	38	82	6875.40.24	100
36	34	60	78	6875.40.36	100
50	45	80	82	6875.40.50	50

OFB = Oberflächendeckung OFB = Percentage of the surface covered by fabric



EN 45545-2
HL 3

Polyester PET Grau matt				Polyester PET Grey matt	
NW	Ø min mm	Ø max mm	OFB %	Art.-Nr. Art. No.	
3	3	6	86	6875.70.03	200
4	4	8	85	6875.70.04	200
5	3	10	89	6875.70.05	200
8	6	14	81	6875.70.08	150
10	8	20	79	6875.70.10	150
15	13	25	81	6875.70.15	100
20	15	30	77	6875.70.20	100
24	24	38	82	6875.70.24	100
36	34	60	78	6875.70.36	100
50	45	80	82	6875.70.50	50

OFB = Oberflächendeckung OFB = Percentage of the surface covered by fabric



Spenderbox | Dispenser Box

EN 45545-2
HL 3

Schwarz				Black	
NW	Ø min mm	Ø max mm	i info	Art.-Nr. Art. No.	
5	3	10	12 m	6875.40.05.10	1
10	8	20	12 m	6875.40.10.10	1
18	18	27	6 m	6875.40.18.06	1
30	23	50	6 m	6875.40.30.06	1



AGRO Geflechschläuche Kunststoff

AGRO synthetic braided cable sleeving

AGROflex PA Geflechschläuche Polyamid

Material:	Polyamid PA 6
Monofil:	Ø 0.25mm
Eigenschaften:	Hochflexibel, selbstanpassend, abriebfest, frei von Cadmium, Formaldehyd, Halogen und Graphit, selbstverlöschend nach DIN 75200 (FMVSS 302), gute Beständigkeit gegen Kraftstoffe, Mineralöle und viele weitere Chemikalien
Aufweitung:	Aufstauchverhältnis 1 : 2
Einsatztemperatur:	-40°C / +125°C

AGROflex PA braided cable sleeveings polyamide

Material:	Polyamide PA 6
Monofil:	Ø 0.25mm
Properties:	Highly flexible, self-adapting, resistant to abrasion, free of cadmium, formaldehyde, halogen and graphite, self-extinguishing acc. to DIN 75200 (FMVSS 302), good resistance to fuel, mineral oil and many other chemicals
Expansion:	Expansion ratio 1 : 2
Temperature range:	-40°C / +125°C



Polyamid PA 6 Schwarz				Polyamide PA 6 Black	
NW	Ø min mm	Ø max mm	OFB %	Art.-Nr. Art. No.	
3	2.5	6.0	85	6850.40.03	100
4	3.0	8.5	91	6850.40.04	200
5	4.0	10.0	95	6850.40.05	100
6	4.0	9.0	85	6850.40.06	100
8	6.0	11.0	90	6850.40.08	100
10	7.0	13.5	90	6850.40.10	100
12	9.0	17.0	94	6850.40.12	100
14	10.0	22.0	85	6850.40.14	100
16	14.0	23.0	87	6850.40.16	100
18	16.0	24.0	88	6850.40.18	100
20	18.0	27.0	83	6850.40.20	100
22	18.0	32.0	84	6850.40.22	50
24	21.0	34.0	71	6850.40.24	50
25	18.0	34.0	85	6850.40.25	50
30	26.0	40.0	88	6850.40.30	50
35	28.0	40.0	88	6850.40.35	50
40	28.0	42.0	93	6850.40.40	50
45	38.0	58.0	84	6850.40.45	50
50	35.0	80.0	88	6850.40.50	50
70	55.0	80.0	91	6850.40.70	50

OFB = Oberflächendeckung
Grau auf Anfrage

OFB = Percentage of the surface covered by fabric
Colour grey on request

AGROflip B selbstschliessender Geflechschlauch | AGROflip B self-closing braided sleeving

AGROflip B selbstschliessender Geflechschlauch

AGROflip B self-closing braided sleeving

Material: Polyester PET
 Monofil: Ø 0.25mm
 Einsatzbereich: Problemloses Einziehen von vorkonfektionierten Kabeln, für nachträgliche Installation
 Eigenschaften: Hochflexibel, selbstanpassend, abriebfest, frei von Cadmium, Formaldehyd, Halogen und Graphit, selbstverlöschend nach DIN 75200 (FMVSS 302), gute Beständigkeit gegen Kraftstoffe, Mineralöle und viele weitere Chemikalien
 Einsatztemperatur: -50°C / +150°C

Material: Polyester PET
 Monofil: Ø 0.25mm
 Application: Sinking of pre-connectorised cables without problems, for additional installation
 Properties: Highly flexible, self-adapting, resistant to abrasion, free of cadmium, formaldehyde, halogen and graphite, self-extinguishing acc. to DIN 75200 (FMVSS 302), good resistance to fuel, mineral oil and many other chemicals
 Temperature range: -50°C / +150°C

AGROflip B Schwarz		AGROflip B Black	
NW	Ø max mm	Art.-Nr. Art. No.	
6	6	6878.40.06	25
9	9	6878.40.09	25
13	13	6878.40.13	25
19	19	6878.40.19	20
25	25	6878.40.25	20
32	32	6878.40.32	20
38	38	6878.40.38	20
50	50	6878.40.50	20

Nominaler Innendurchmesser mit einer Überlappung von 25% / 90° Nominal inner diameter with 25% / 90° overlap



1
2
3
4
5
6
7
8
9
10
11
12

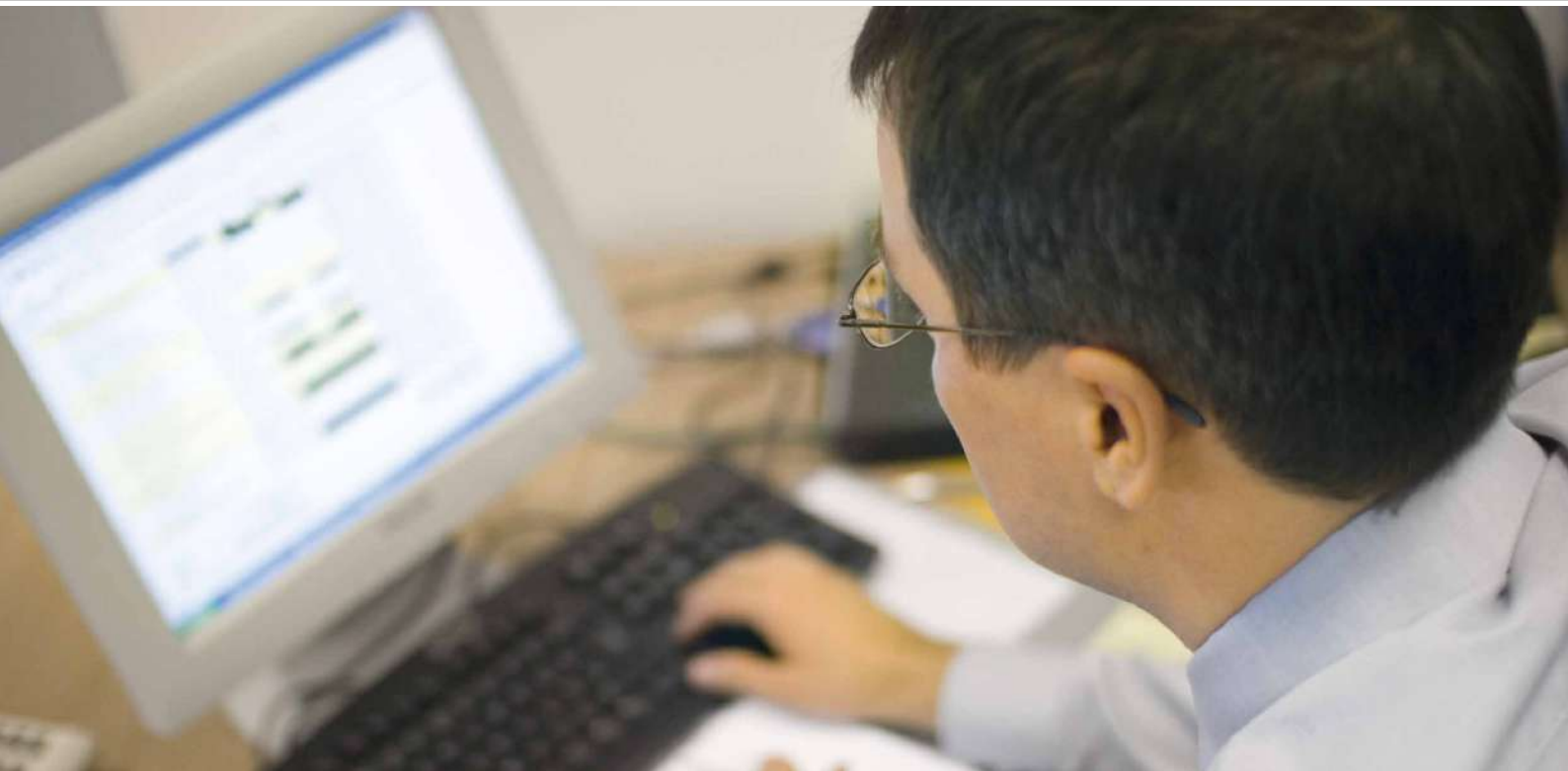

- **AGRO online**
- **Dynamische Produktsuche**
- **Merkliste**
- **Produktvergleich**
- **3D-Ansicht**
- **CAD-Download**
- **Anfragefunktion**

Auf unserer Website www.agro.ch bieten wir Ihnen **umfangreiche Informationen**. Dank der **benutzerfreundlichen Navigation** und der **dynamischen Suchfunktionen** finden Sie die zu Ihrer Anwendung passenden Kabelverschraubungen hier in Sekundenschnelle. Die **Produktansicht** zeigt alle technischen Daten sowie Zulassungen auf einen Blick. Aus jeder Produktansicht können Sie ein **Produktdatenblatt im PDF-Format** generieren. Die gewählten Produkte können Sie in einer **Merkliste** speichern, welche eine Vielfalt an Funktionen bietet – z. B. Produktvergleich, Medien-Download oder Anfrageformular. Die **CAD-Daten** zu allen Kabelverschraubungen sind online hinterlegt. Diese können entweder in einer dynamisch generierten **3D-Ansicht** angezeigt werden oder lassen sich in allen gängigen CAD-Formaten an die eigene E-Mail-Adresse senden. Wir freuen uns auf Ihren virtuellen Besuch auf unserer Website!

- **AGRO online**
- **Dynamic product searching**
- **Memo list**
- **Product comparison**
- **3D display**
- **CAD download**
- **Inquiry function**

You can find **comprehensive information** on our www.agro.ch website. The **user-friendly navigation** and the **dynamic search functions** ensure that you will find the cable glands you need for your application in just a few seconds. The **product overview** shows all the technical information and also technical approvals at a glance. You can generate a **pdf-format product data sheet** from every product overview. In addition, you can store the products you need for your application in a memo list which gives you a wide range of functions, for example product comparisons, media download or an inquiry form. We have put online the **CAD data** on all cable glands. The data can be displayed as a dynamically-generated 3D format or can be sent to an email address in all standard CAD formats. We look forward to your virtual visit to our website!



Youku Kanal deutsch

Neu: Produkt-Animationen für Ihr Smartphone

Der QR Code ermöglicht Ihnen einen schnellen und bequemen Zugriff auf unsere informativen Produkt-Animationen mit Ihrem Smartphone. Probieren Sie es aus! Über diesen QR Code erhalten Sie den Zugang auf eine Präsentation unseres Kabelverschraubungs-Sortimentes.

New: Product animations for your smartphone

The QR codes give you fast, easy access to our informative product animations via your smartphone. Try it - you'll like it! By activating this QR Code, you will get access to the presentation of our assortment of cable glands.



YouTube



Spezielle Einführungslösungen Special entry solutions	242 - 243	1
Prüfzeichen Approval Marks	244 - 245	2
Brandschutz für Schienenfahrzeuge nach EN 45545 Fire protection in railway vehicles according to EN 45545	246 - 247	3
Progress® Baukasten und AGRO Sonderlösungen Progress® modular assembly parts and AGRO special solutions	248 - 253	4
AGRO Prüftechnik AGRO Test laboratory	254 - 257	5
Montageanleitungen Kabelverschraubungen Assembly instructions cable glands	259 - 263	6
Gewindetabelle Chart of threads	264	7
Verzeichnis der Schutzarten (IP) List of Protection Classes (IP)	265	8
Materialübersichtstabellen List of materials	266 - 270	9
Suchhilfen Search helps	271 - 282	10
		11

1
2
3
4
5
6
7
8
9
10
11

12



AGRO Kabelverschraubungen - die Alleskönner

Unser Standard-Sortiment an Kabelverschraubungen ist darauf ausgerichtet, ideale Einführungslösungen für Standardapplikationen zu bieten.

In manchen spezifischen Situationen muss die Kabelverschraubung den konkreten Anforderungen angepasst werden. Sehr oft ist es ausreichend, die Bestandteile des Progress® Baukastens individuell zusammenzustellen, um eine passende Lösung zu finden. Alle Einzelkomponenten des Baukastens sind kompatibel und können frei kombiniert werden.

Manche Montagesituationen oder Anforderungen sind jedoch besonders, und es muss eine spezifische Einführungslösung gefunden werden. Auch für diesen Fall bietet der Progress® Baukasten die notwendige Flexibilität für schnelle und kostengünstige Einzelanfertigungen.

Kabelverschraubungen können auf jeder Stufe des Baukastens den Anforderungen entsprechend individualisiert werden.

Wir können alle technischen Gewinde in verschiedenen Materialien umsetzen und Dichteinsätze im Hinblick auf Anzahl, Form der Durchführungen und Materialwahl so individualisieren, dass den Anforderungen genau entsprochen wird. Langfristige Funktionssicherheit ist das oberste Ziel.

Sprechen Sie mit uns, wenn Sie Kabel in Ihr Gerät einführen müssen. Wir finden eine einfachere, rationellere oder schönere Lösung für Sie!

AGRO cable glands – the all-rounders

Our standard range of cable glands is designed to provide ideal cable entry solutions for standard applications.

In some specific situations, the cable gland must be adapted to special requirements. It is often possible to find a suitable solution simply by assembling the Progress® kit's components in an appropriate way. All individual components of the kit are compatible and can be easily combined.

However, in some cases, a special cable entry solution must be developed. In this case too, the modular design of the

Progress®-system enables any single component of the cable gland to be customised individually, making the process fast and cost-effective.

We can supply cable glands with any required thread type, in various materials and customise sealing inserts in terms of material and of number and shape of cable entries in order to meet all requirements. Long-term reliability is the top priority.

Contact us, if your equipment needs cable entries. We will find a nicer, simpler or more efficient solution for you!

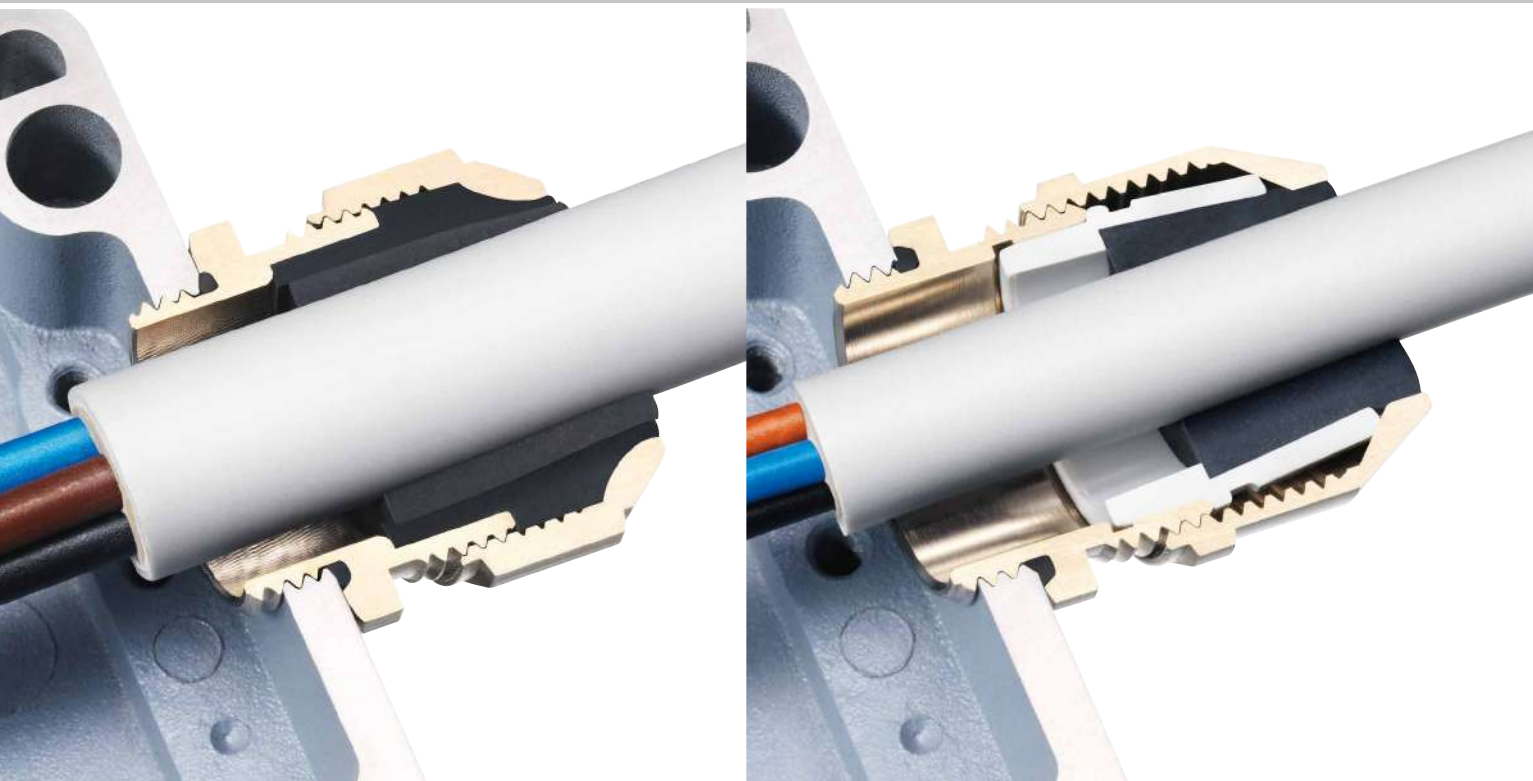

Progress® in Messing, Stahl oder Kunststoff

AGRO Kabelverschraubungen Progress® mit herausragender Kompressionstechnik sorgen für eine hohe Dichtigkeit und eine äusserst kabelschonende Zugentlastung auch bei dynamischen Belastungen. Dichteinsätze für spezifische Anwendungen wie Bahnapplikationen nach EN 45545, im Trinkwasserbereich, in der Lebensmittel- und Reinraumtechnologie oder bei hohen Temperaturen sind standardmässig verfügbar.

- 1 Kurze, lange oder Spezial-Anschlussgewinde in metrischer, Pg-, Gasrohr oder NPT-Ausführung
- 2 Hoher Verdrehenschutz dank Längsrandrierung im Dichteinsatz
- 3 Zweiteilige Dichteinsätze erweitern den Klemmbereich
- 4 Auf den Dichteinsatz abgestimmte Innenkonturen sorgen für eine zielgerichtete Verformung des Dichteinsatzes und garantieren die Schutzart IP 68 bis 10 bar sowie IP 69



Progress® in brass, steel or synthetic material

The outstanding compression technology of AGRO Progress® cable glands ensures an effective sealing and excellent cable-protecting strain relief, also for dynamic loads. Sealing inserts for special applications such as railway applications according to EN 45545 or for drinking water, food industry or cleanroom applications are available as standard.

- 1 Short, long or special entry threads (metric, PG, gaspipe or NPT)
- 2 High distortion protection thanks to longitudinal grooves in the lower part
- 3 Two-piece sealing inserts for larger clamping range
- 4 Inner contours matched to the sealing insert cause the desired deformation ensuring sealing performance in compliance with protection class IP 68 up to 10 bar and IP 69

Syntec® in Messing oder Kunststoff

Kabelverschraubungen Syntec® sind mit ihrer innovativen Lamellentechnik speziell geeignet für den flexiblen und sicheren täglichen Einsatz. Die Vorfixierung der Kunststoff Druckmutter erleichtert Überkopf-Montagen.

- 1 Kurze oder lange Anschlussgewinde in metrischer, Pg oder NPT-Ausführung
- 2 Elastische und umweltbeständigen Dichtringe garantieren die Schutzart IP 68.
- 3 Die Lamellengeometrie mit beweglichen Gelenklamellen ermöglicht das Einführen verschiedener Kabeldurchmesser bei hervorragender Zugentlastung und exzellentem Verdrehenschutz.
- 4 Der grossflächige Sechskant der Druckmutter der Kunststoffausführungen bietet sicheren und festen Halt



Syntec® in brass or synthetic material

Syntec® cable glands with their innovative lamellar technology are particularly suitable for flexible, reliable everyday use. The pre-fixation of the synthetic compression nut facilitates easy overhead installation.

- 1 Short or long entry threads (metric, PG- or NPT)
- 2 The elastic sealing rings with good chemical resistance provide a reliable seal, are particularly durable and offer guaranteed protection to protection class IP 68
- 3 Lamellar geometry with movable jointed lamellas facilitate the insertion of cables of varying diameters and ensure outstanding strain relief and distortion protection
- 4 The large spanner flats of the synthetic compression nuts ensure a reliable and secure spanner grip when turning

1
2
3
4
5
6
7
8
9
10
11
12



SEV

Das SEV-Bewilligungszeichen wird auf Grund bestandener Prüfungen bei ElectroSuisse vom ESTI erteilt. Grundlage für Kabelverschraubungen ist hierbei die europäische Norm EN 62444.

SEV

The SEV mark of approval is awarded by ESTI as a result of tests conducted by ElectroSuisse. European standard EN 62444 forms the basis for cable glands.



VDE

Das VDE-Zeichen kennzeichnet die Konformität mit den VDE-Bestimmungen bzw. europäischen oder international harmonisierten Normen und bestätigt die Einhaltung der Schutzanforderungen der zutreffenden Richtlinien. Das VDE-Zeichen steht für die Sicherheit des Produktes hinsichtlich elektrischer, mechanischer, thermischer und sonstiger Gefährdung.

VDE

The VDE certification mark signals conformity with the VDE provisions and European or internationally harmonised standards and confirms that the safety requirements fulfil the applicable guidelines. The VDE mark stands for the safety of the product in terms of electrical, mechanical, thermal and other hazards.



C-UL / US Listing Zeichen

Dieses Prüfzeichen wird bei Produkten verwendet, die auf kanadischen und U.S.-Märkten vertrieben werden. Es weist darauf hin, dass die kanadischen und die U.S.-Anforderungen für klassifizierbare Produkte erfüllt wurden.

C-UL / US Listing Mark

This approval mark is used for products that are distributed in the US and Canadian markets. It indicates that the US and Canadian specifications for classifiable products have been fulfilled.



Recognized Component Zeichen für Kanada und die USA

Das Recognized Component Mark von UL darf für Komponenten verwendet werden, die Bestandteil eines grösseren Produktes oder Systems sind. Diese sind von UL gemäss kanadischen und U.S.-Anforderungen zertifiziert.

Recognized Component Mark for Canada and the USA

The UL Recognized Component Mark can be used for components that are part of a larger product or system. These are certified by UL in accordance with US and Canadian requirements.



Zollunion - EAC

Das Zertifikat der Zollunion - EAC ist ein offizieller Nachweis dafür, dass die Produkte den nationalen technischen Vorschriften der teilnehmenden Länder entsprechen. Als Vorbild für das neue gemeinsame Zertifizierungssystem wurde das russische TR Zertifizierungsverfahren hergenommen. Die Erzeugnisse, deren Konformität mit den technischen Vorschriften durch das Zertifikat der Zollunion bescheinigt wird, dürfen frei im ganzen Zollgebiet aller Mitgliedstaaten der Zollunion über die Grenzen bewegt und verkauft werden.

EAC customs union certificate

The EAC customs union certificate is official proof that a product complies with the national technical regulations of the participating countries. The Russian TR certification process was used as a model in developing the new common certification system. Products whose conformity with technical regulations have been verified by the customs union's certificate may be freely moved across borders and sold across the entire free trade area.



Det Norske Veritas (DNV)

Det Norske Veritas (DNV) ist eine Schiffsklassifikations-Gesellschaft in Form einer Stiftung. Sie klassiert und erteilt Zertifikate zum unbedenklichen Einsatz von Produkten auf Schiffen. DNV wurde 1864 in Oslo gegründet.

Det Norske Veritas (DNV) is a maritime classification society organized as a foundation. It classifies and issues certificates for the safe use of materials and components on ships. DNV was founded in 1864 in Oslo.

Internationale Elektrotechnische Kommission

Die Internationale Elektrotechnische Kommission, kurz: IEC (von engl. International Electrotechnical Commission) ist eine internationale Normungsorganisation mit Sitz in Genf für Normen im Bereich der Elektrotechnik und Elektronik.



1

International Electrotechnical Commission

The **International Electrotechnical Commission (IEC)** is an international standards organisation with its headquarters in Geneva which develops standards in the areas of electrical equipment and electronics.

IEC Ex

Das IEC Ex-Prüfzeichen ist eine spezielle Kennzeichnung für Explosionsschutz Einrichtungen. Es bedeutet, dass Einrichtungen, Schutzsysteme oder Bauteile den Anforderungen der internationalen und europäischen Norm entsprechen, die mit der Richtlinie 2014/34/EU (ATEX-Direktive, benannt nach der französischen Bezeichnung „ATmosphère EXplosible“) harmonisiert sind.



2

IEC Ex

The IEC Ex mark of conformity is a special identification for equipment and services used in explosive atmospheres. It means that equipment, protective systems or components meet the requirements of the international and European standard which are harmonised with Directive 2014/34/EC (the ATEX directive, named after the French designation "ATmosphères EXplosives").

3

RoHS

„**R**estriction of the use of certain **H**azardous **S**ubstances in electronic equipment“ ist der Titel der EU-Richtlinie 2002/95/EG. Sie verbietet ab 1.7.2006 im gesamten Gebiet der EU den Verkauf von elektrischen Geräten, welche mehr als nur Spuren von Blei, Cadmium, Chrom VI, Quecksilber oder von polybromierten Flammschutzmitteln PBB/PBDE enthalten.

RoHS

4

RoHS

“**R**estriction of the use of certain **H**azardous **S**ubstances in electronic equipment“ is the title of EC Directive 2002/95/EC. With effect from 1 July 2006, it forbids the sale of electric equipment which contain more than traces of lead, cadmium, chromium(VI), mercury or polybrominated flame retardants (PBBs and PBDEs) throughout the entire EC.

5

EN 45545

Die EN 45545 setzt sich aus mehreren Teilen zusammen und definiert den Brandschutz in Schienenfahrzeugen. Teil 1 umfasst allgemeine Regeln, Teil 2 (EN 45545-2) ist in Bezug auf gefährliche Rauchgase sehr wichtig und Teil 3 (EN 45545-3) definiert den Feuerwiderstand von Feuerschutzabschlüssen (Raumabschlüsse).

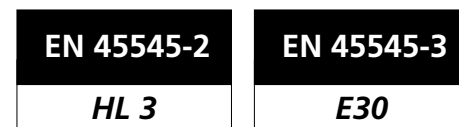

6

EN 45545

The EN 45545 standard consists of several parts. Part 1 covers general requirements, part 2 (EN 45545-2) is very important in relation to dangerous smoke gases and part 3 (EN 45545-3) defines the fire resistance requirements for fire barriers.

7

NFPA

Die amerikanische Norm NFPA 130 definiert die zulässigen Werte für die Wärmefreisetzung und Rauchentwicklung (ASTM E 1354) sowie die Rauchgas Toxizität (SMP 800) für Produkte, welche in Schienenfahrzeugen zur Anwendung kommen.



8

NFPA

The american standard NFPA 130 specifies permitted values for heat release and smoke emission (ASTM E 1354) as well as smoke toxicity (SMP 800) of products for use in rolling stock applications.

9

10

11

12

AGRO Kabelverschraubungen sind nach EN 45545-2 zertifiziert

AGRO cable glands are certified according to EN 45545-2

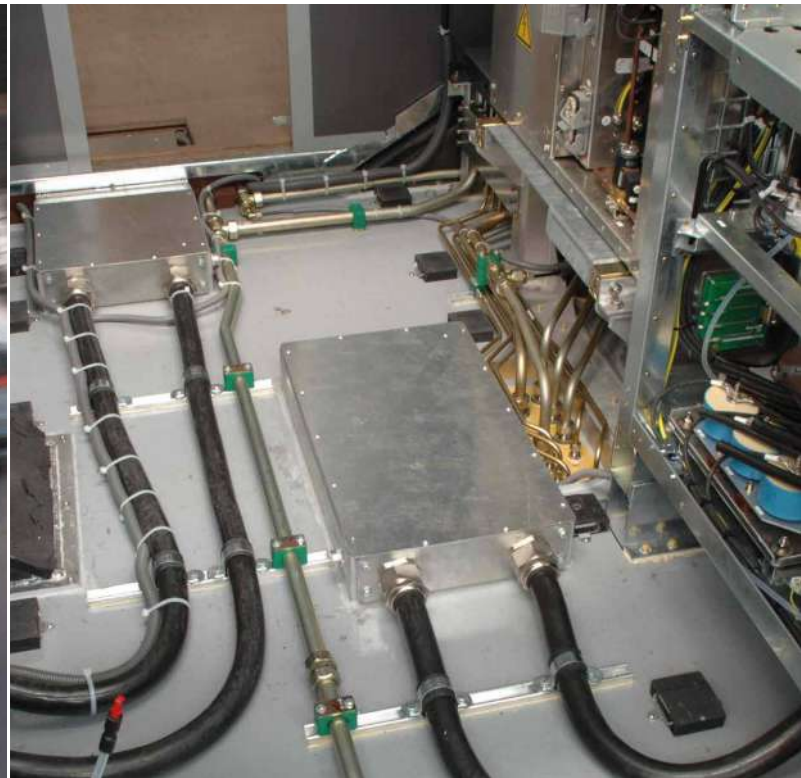

AGRO Progress® bedenkenlos für Schienenfahrzeuge

AGRO Progress® Kabelverschraubungen aus Metall können bedenkenlos für alle Anwendungen und Anordnungen im Schienenfahrzeugbereich eingesetzt werden. Dies bescheinigt das neue Zertifikat.

Die herausragende Progress® Kompressionstechnik sorgt für eine hohe Dichtigkeit und eine äusserst kabelschonende Zugentlastung auch bei dynamischen Anwendungen. Standard- und EMV-Kabelverschraubungen mit dem entsprechenden Zubehör bilden das Basissortiment für nahezu alle Anwendungen. AGRO fertigt bei Bedarf auch zertifizierte Lösungen gemäss Anforderungen der Kunden.

Beste Resultate bei Prüfungen nach EN 45545-2 (Komponenten)

Die Dichteinsätze der Progress® Kabelverschraubung sind aus einem speziellen TPE gefertigt und sind im anspruchsvollsten **Hazard Level 3** zertifiziert.

Die geforderten Werte für Hazard Level 3 wurden sowohl im Aussen- als auch im Innenbereich deutlich übertroffen:

AGRO Progress® - the ideal solution for rolling stock

AGRO Progress® metal cable glands can be used with confidence for any rolling stock application, in any arrangement, as has been recently certified.

The outstanding Progress® compression technology ensures tight seals and offers cables exceptional damage-preventing strain relief, even in dynamic applications. A comprehensive range of standard and EMC cable glands and accessories offers a solution for almost any application. Where the need arises, AGRO also delivers certified solutions according to customer requirements.

Best results in testing according to EN 45545-2 (Components)

The seal inserts of Progress® cable glands are made from a special TPE and certified to the demanding **Hazard Level 3**.

The stipulated values for Hazard Level 3 were exceeded, for both indoor and outdoor areas:

	Normwert für HL 3 aussen Requirement for HL 3 outdoor	Normwert für HL 3 innen Requirement for HL 3 indoor	AGRO Resultat AGRO result
Sauerstoffindex Oxygen index	Min. 32%	Min. 32%	39%
Rauchgasdichte Ds Smoke gas density Ds	Max. 300	Max. 150	110
Toxizität CIT	Max. 1.5	Max. 0.75	0.16

Kabelverschraubungen zertifiziert für den Einsatz in Schienenfahrzeugen

Cable glands certified for rolling stock applications



Material: Messing vernickelt
Material Dichteinsatz: Spezial AGRO TPE AGRO TPE
Farbe Dichteinsatz: Hellgrau RAL 7035
Gewinde: M12 bis M63
Pg 7 bis Pg48

Einsatztemperatur: -50°C / +105°C

Schutzart: IP 68 / IP 69 K
Weitere Normen: EN 50262 / EN 62444

Material: Nickel-plated brass
Material sealing insert: Special AGRO TPE
Colour sealing insert: Light grey RAL 7035
Threads: M12 to M63
Pg 7 to Pg48M12 M63
Pg 7 Pg48

Temperature range: -50°C / +105°C-50°C / +105°C

Protection class: IP 68 / IP 69 K
Further standards: EN 50262 / EN 62444

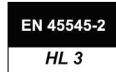

AGRO Kabelverschraubungen sind nach zertifiziert

AGRO cable glands are certified according to EN 45545-3

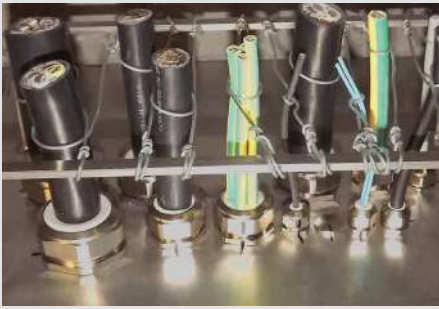

Ausgangssituation | Initial situation



Nach 10 Minuten | After 10 minutes



Nach 20 Minuten | After 20 minutes



Nach 30 Minuten | After 30 minutes



Nach 35 Minuten | After 35 minutes



Nach 44 Minuten | After 44 minutes

Vorgaben der EN 45545-3 übertreffen!

Die EN 45545-3 definiert die Anforderungen an den Feuerwiderstand für Feuerschutzabschlüsse. Ziel der EN 45545-3 ist es, die Brandausbreitung durch Materialanforderungen zu begrenzen. Wenn Kabel durch Feuerschutzabschlüsse geführt werden, gelten diese Anforderungen auch für Kabelverschraubungen.

Um festzustellen, ob der geforderte Feuerwiderstand erreicht wird, werden die Komponenten in einem Prüfofen in Hinblick auf die Kriterien Raumabschluss, Wärmedämmung und Strahlenemission geprüft.

AGRO Progress® Kabelverschraubungen aus Metall übertreffen die Vorgaben der EN 45545-3 bei weitem und erreichen die sehr hohe Feuerwiderstandsklasse E30. Dies bedeutet, dass die Dichteinsätze mindestens 30 Minuten lang dicht sind und einen Flammenübertrag auf die dem Feuer abgewandte Seite verhindern. Es bilden sich keine Spalten. Sie können aus brandschutztechnischer Sicht bedenkenlos in allen Schienenfahrzeugen eingesetzt werden.

Exceeding the demands of EN 45545-3!

EN 45545-3 defines the requirements for fire resistance of fire barriers. The aim of EN 45545-3 is to limit fire spread by specifying the performance of materials and components. If cables are routed through fire barriers, the requirements apply also to the cable glands used.

In order to establish whether or not the required fire resistance is achieved, components are tested in a testing furnace with respect to requirements for fire barrier, thermal insulation and radiation emission.

AGRO Progress® metal cable glands easily exceed the requirements of EN 45545-3 and satisfy the very high demands of fire resistance class E30. This means that the seal inserts remain impervious and prevent the spread of fire through the gland for at least 30 minutes. They do not crack or fissure. From a fire protection perspective, they can be used without hesitation in all railway vehicles.



EN 45545-3
E30

	Einbaulage vertikal Vertical installation	Einbaulage horizontal Horizontal installation	Klassierung Classification
AGRO Resultat AGRO result	44 min	41 min	E30

Der Brandversuch wurde durchgeführt mit AGRO Progress® Kabelverschraubungen Messing vernickelt und Dichteinsätzen aus Spezial AGRO TPE, Größen M16 bis M50, sowie mit Multi-Kabelverschraubungen und Verschlusschrauben.

Fire testing was carried out using AGRO Progress® nickel-plated brass cable glands and seal inserts of Special AGRO TPE, sizes M16 to M50, and with multicable glands and locking screws.

1
2
3
4
5
6
7
8
9
10
11
12

Progress®: Der Baukasten – Messing

Progress®: Modular assembly parts – nickle-plated brass

Der modulare Aufbau unserer Kernserie Progress® ist eine ihrer ganz grossen Stärken.. Die Bauteile sind aufeinander abgestimmt und können frei kombiniert werden. Kundenspezifischen Anforderungen kann flexibel, pragmatisch und schnell entsprochen werden. Wir kombinieren für Sie das passende Ober- und Unterteil mit dem richtigen Dichteinsatz und finden so die effektive und effiziente Lösung für Ihre Montagesituation.

The modular design of our Progress®-range is one of its great strengths. The components are designed with the others in mind, and can be freely combined with each other. Customer-specific requirements can be flexibly, practically and quickly met. We will combine the most suitable upper and lower parts with the right sealing insert for you, and thus deliver the most effective, most efficient solution for your needs.

Standard Oberteil | Upper part



Knickschutz
Antikink spring



Klemmbacken
Clamps



Trompete
Trumpet



Klemmbacken und Trompete
Trumpet with clamps



Schlauchverschraubungen
Conduit glands



Standard-Druckmutter
Standard compression nut

Standard Dichteinsatz | Standard sealing inserts



Kurzer ein- oder zweiteiliger Dichteinsatz in NBR, TPE, Spezial TPE nach EN 45545 oder FPM (temperatur-beständig)
Short one or two-piece sealing insert made of NBR, TPE, special TPE according to EN 45545 or FPM (heat resistant)

Langer durchgehend isolierender Dichteinsatz in NBR, TPE, Spezial TPE nach EN 45545 ein oder zweiteilig
Long one or two-piece overall length insulating sealing insert made of NBR or TPE special TPE according to EN 45545

Für die gängigsten Kabeldurchmesser sind Dichteinsätze für die Durchführung mehrerer Kabel verfügbar
For the most common cable diameters, sealing inserts are available for the entry of several cables at once

Standard Unterteil | Standard lower Part



mit kurzem Anschlussgewinde
with short entry thread
- metrisch / metric
- Pg
- NPT
- Gasrohr / gaspipe



mit langem Anschlussgewinde
with long entry thread
- metrisch / metric
- Pg
- NPT
- Gasrohr / gaspipe



Wenn die Anforderungen ganz spezifisch sind, können wir diesen auf jeder Stufe des Progress®-Baukastens mit individualisierten Komponenten gerecht werden: sowohl Drehteile als auch Dichtensätze können optimal auf die Kundenbedürfnisse abgestimmt werden. Eine optimale Lösung bietet eine geringere Montagezeit und ein Gewinn an Sicherheit.

Where requirements are very specific, we custom-design each individual component of our Progress® cable glands accordingly: both metal parts and sealing inserts can be tailored to optimally meet your needs, reducing assembly time and enhancing reliability.

Kundenspezifische Oberteile | Customised upper parts



Oberteile können im Hinblick auf die Bauform und das Gewinde individualisiert werden.

In Zusammenarbeit mit den Kunden wird ein Bauteil entwickelt, welches den individuellen Anforderungen am Besten entspricht und den optimalen Nutzen bietet.

Upper parts can be customised for shape and thread. By working closely with the customer, a component is developed which best meets individual requirements and offers superior benefit to the user.

Individualisierte Dichtensätze | Customised sealing inserts



Dichtensätze können auf der Ebene der Form und Anzahl der Durchführungen und auf der Ebene der Materialwahl individualisiert werden. Wir bearbeiten folgende Materialien:

Sealing inserts can be customised for shape and number of feedthroughs and also with regard to the selection of material. We work with the following materials:

- NBR
- TPE-V
- FPM
- Silikonkautschuk / silicone caoutchouc
- EPDM
- TPE
- HNBR

Kundenspezifische Unterteile | Customer-specific lower parts

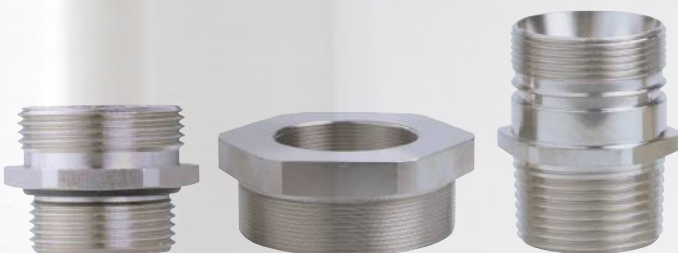

Unterteile können im Hinblick auf die Bauform und das Anschlussgewinde individualisiert werden. Sämtlichen Größen und kundenspezifischen Längen sind in folgenden Gewindearten möglich:

Lower parts can be customised for shape and entry thread. All sizes and customer-specific lengths are available with the following types of threads:

- metrisch / metric
- Pg
- NPT
- Gasrohrgewinde / gas pipe

Sonderlösung Schienenfahrzeug

Special solutions for railway vehicles

Die Anforderungen

- EMV-gerechte Einführung von sechs ungeschirmten Kabeln
- Verbindung Stromrichter - Trafo
- Schutzart IP68 innen und aussen. Dadurch wird verhindert, dass Kondenswasser, welches sich möglicherweise innerhalb des Schlauches bildet, in den Traforaum eindringt

Die Lösung von AGRO

- Progress®-Spezialverschraubung M75 mit geschlitztem Multi-Dicht-einsatz zur leichteren Kabelmontage
- kombiniert mit Metallschutzschlauch

The Requirements

- EMC-proof feedthrough of six unshielded cables
- Connection from power rectifier to transformer
- Protection class IP68 inside and out. This prevents condensate which could possibly build up inside the conduits from making its way into the transformer room

The AGRO solution

- Progress® M75 special cable gland with slotted multi-sealing insert for easier cable assembly
- Combined with metal conduit

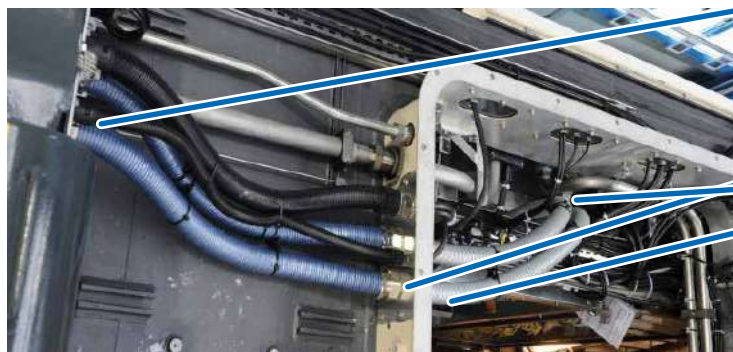

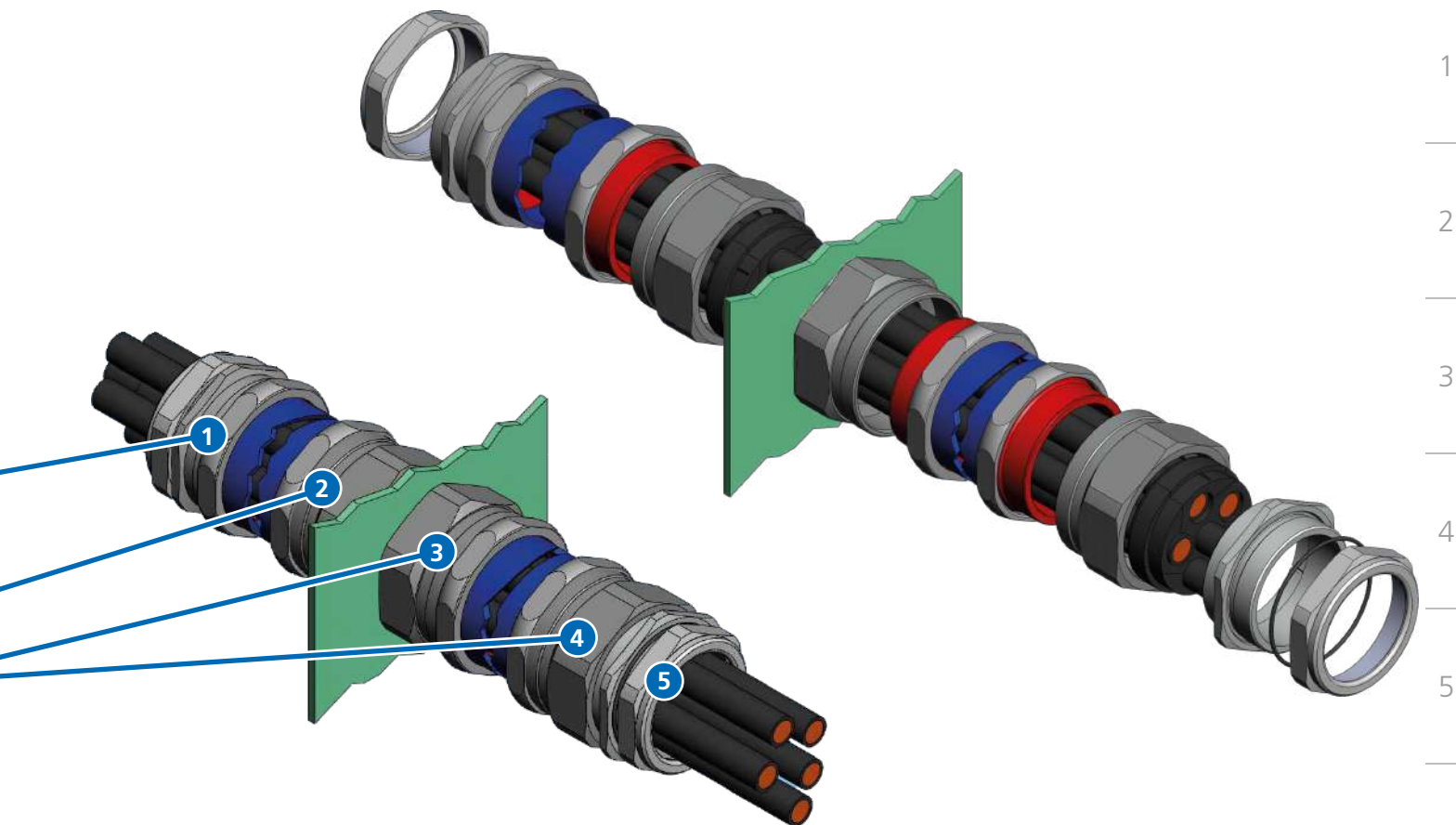

- 1 Schlauchverschraubung zur Befestigung des Metall-Kabelschutzschlauches. Innerhalb des Schutzschlauches werden sechs Stromkabel geführt. Der Metallschutzschlauch funktioniert über seine Verbindung mit den Gehäusen aus Metall als äußerer EMV-Schutz
- 2 Kombi-Schlauchverschraubung mit Progress® Multi-Dichteinsatz zur dichten Einführung der Kabel in den Traforaum (Schutz vor Feuchtigkeit von aussen)
- 3 Schlauchverschraubung zur Aufnahme des Metallschutzschlauches (Weiterführung des EMV-Schutzes)
- 4 Kombi-Schlauchverschraubung (identisch mit 2) zur Einführung der Kabel in den Trafo (Schutz vor Feuchtigkeit von innen)
- 5 Gegenmutter zur Befestigung der Kombi-Schlauchverschraubung

- 1 Conduit gland to secure the metal conduit. Six power cables are run within the conduit. The metal conduit functions as an exterior EMC shield through its connection with the metal enclosures
- 2 Combination conduit gland with Progress® multi-sealing insert for sealed cable feedthrough into the transformer room (protection from outside moisture)
- 3 Conduit gland to accept the metal conduit (extension of EMC protection)
- 4 Combination conduit gland (identical to #2) for cable feedthrough into the transformer room (protection from interior moisture)
- 5 Locknut to secure the combination conduit gland

Sonderlösung Kabelverschraubung Knabberschutz

Rodent-proof special cable gland solution



© ABB

Wenn Nager zum Sicherheitsrisiko werden

Manch einer kennt das Phänomen aus eigener Erfahrung: das Auto will sich am Morgen nicht starten lassen, und der Reparaturdienst stellt fest, dass Gummiteile von Mardern weggefressen worden sind.

Marder, Nager und Vögel lieben Gummi. Die Konsistenz und der Duft von Gummi zieht Kleintiere an und sie knabbern ihn an. Frei geknabberte Kabel führen zu Kurzschlüssen und Funktionsstörungen. Wenn ummantelte Kabel in einem natürlichen Umfeld eingesetzt werden, so muss mit einem Nagerschaden gerechnet werden und entsprechende Vorsichtsmaßnahmen sind sinnvoll.



Nagerschaden an Kabel / Rodent damage to a cable

ABB baut Schaltanlagen, die in der ganzen Welt unter unterschiedlichsten Umweltbedingungen eingesetzt werden.

Möglichen Schäden durch Nager wird standardmässig vorgebeugt, indem die Kabel, welche Generatorschutzschalter und Steuer-schrank verbinden, in einem mit Polyurethan ummantelten flüssigkeitsdichten Schlauch mit Stahlwendel geführt werden. Zur IP68 dichten Einführung der im Schlauch geführten Kabel entwickelte AGRO in Zusammenarbeit mit ABB eine individualisierte Lösung, welche eine feuchtigkeitsdichte Verbindung von Schlauch- und Kabelverschraubung sowie einen sicheren EMV Abgriff ermöglicht. Mit dieser Lösung werden zwei Probleme auf einmal gelöst: die Kabelführung und -Einführung ist feuchtigkeitsdicht und vor Nagern geschützt.

When rodents become a safety risk

Many of us know the phenomenon from personal experience: the car just won't start in the morning and the mechanic finds that rubber parts have been gnawed away by martens.

Just like martens, rodents and also birds love rubber. Small animals seem to be magically drawn to rubber by its consistency, or maybe its scent, and nibble away at it. Damaged cables can result in short circuits and loss of functionality. If shrouded cables are to be used in a natural setting, the risk of rodent damage should be recognised and appropriate precautions taken.



Nagersicherer Kabelschutz mit / Rodent proof cable protection Progress® EMV Serie 85

ABB manufactures gas insulated switchgear that is used all around the world in the most varying environments.

Possible damage by rodents is prevented, as standard, by the use of a polyurethanesheathed, liquid-tight conduit with a steel coil to protect cables connecting circuit breakers and control cabinets. For the IP68-compliant entry of the cable into the conduit, AGRO developed, in cooperation with ABB, an individualised solution which facilitates a liquid-tight connection of conduit and cable and a reliable EMC tap. This solution solves two problems at once: the cable route, and in particular the entry point of the cable into the conduit, are liquidtight, and the cable is also protected from rodents.



Die Ausgangslage

Das Sicherheitsdispositiv im Gotthardtunnel ist hoch und sieht die permanente Überwachung der zirkulierenden Züge vor. In relativ kurzen Abständen überprüfen so genannte Achszählgeräte die Vollständigkeit des Zuges. Die Geräte sind den rauen Bedingungen im Tunnel sowie Steinschlag ausgesetzt.

Die Anforderungen

Die stromführenden Kabel sollten mit einem schlagfesten Schlauch vor Schotterschlag geschützt werden. Die Verbindung Kabelverschraubung-Schlauch sollte auf möglichst einfache Weise erfolgen.



Progress® mit Schlauchanschluss / Progress® with hose connection

Die Lösung von AGRO

Grundlage des Lösungsansatzes bildet eine Standard Progress® Kabelverschraubung. Sie wird ergänzt durch eine kundenspezifische Schlauchanschlusshülse für die einfache und ausreissfeste Aufnahme für den Schutzschlauch.

Eine Verschlusskappe verschliesst die Kabeleinführung mit einer Dichtigkeit von IP 68, solange diese unbelegt bleibt.



The situation

Safety arrangements in the Gotthard tunnel are extensive and provide for permanent monitoring of trains as they pass through. At relatively short intervals, so-called axle counters check the completeness of the train. The equipment is exposed to rough tunnel conditions, including stone impacts.

The requirements

The power cables should be protected from stone ballast by an impact-resistant conduit. The connection between cable gland and conduit should be as simple as possible.



Achszähler / Axle counter

The AGRO solution

The solution is based on a standard Progress® cable gland. It is supplemented by a customised conduit connection sleeve for a simple and tension-resistant fitting for the protective conduit.

When not in use, a cap seals the cable entry to IP 68 requirements.





Glühdrahttest bei 850°C
Glow wire test at 850°C



Druckprüfung zur Ermittlung des IP Schutzes
Pressure test for the determination of the degree of IP protection

Das Arbeiten und Leben mit Strom birgt Risiken. Normen und staatliche Richtlinien wollen diese Risiken minimieren und Installateuren, Monteuren und zu guter Letzt auch dem Endnutzer mehr Sicherheit bieten.

Geprüfte und zertifizierte Produkte geben dem Installateur Sicherheit bei der Montage und die Gewissheit, dass das Produkt seine Funktion über viele Jahre erfüllen wird.

AGRO erfüllt die relevanten Anforderungen nach IEC 60335-1:2014 und OD ECS 035 bzw. 037 für die Anerkennung von Prüfberichten im CTF/MTL Verfahren. Unser Labor entspricht den anwendbaren Anforderungen aus der ISO/IEC 17025:2005. (Allgemeine Anforderungen an die Kompetenz von Prüf- und Kalibrierlaboratorien). Im Klartext heisst dies: AGRO AG verfügt über das nötige normative Wissen, um Produkte schnell und sicher zu prüfen.

Die Zulassungsstelle garantiert die Zertifizierung von Prüfberichten aus dem auditierten AGRO Herstellerlabor.

Was nützt das dem Kunden aus der Elektrobranche, Maschinen und Automatisierungsindustrie?

Working and living with electricity inevitably involves risks. Standards and government directives have the goal of minimising these risks and offering additional safety to electricians, fitters and most of all the end user.

Products which have been tested and certified provide the fitter with security during installation and assembly. This testing also provides the certainty that the product will perform its function for many years.

AGRO meets the relevant requirements according to IEC 60335-1:2014 and OD ECS 035 or 037 for the recognition of test reports according to the CTF/MTL procedure. Our laboratory complies with the applicable requirements of ISO/IEC 17025:2005. (General requirements for the competence of testing and calibration laboratories.) In simple terms, this means that AGRO AG has the necessary normative knowledge to test products quickly and safely.

The accreditation body guarantees the certification of test reports prepared by the audited AGRO manufacturer's laboratory.

What value does this have for customers from the electrical or machinery sectors or automation industry?



Film: Prüflabor



Film: Test Laboratory



Zugprüfung an einer Kabelverschraubung
Tensile test on a cable gland



Massprüfung mittels Messprojektor
Measurement with a projector

Im Mittelpunkt der Prüfung

Das erfolgreiche Bestehen der Prüfung durch die Zulassungsstellen gibt dem Konsumenten die Gewähr, dass der Hersteller eines Produktes über das notwendige normative Wissen verfügt und dass die Prüfeinrichtungen für die Durchführung von Prüfungen nach offiziellen Standards geeignet sind. Geprüft wurden unter anderem die IP-Druckprüfanlage (Schutzart IPX8 bis 10 MPa (100 bar) und die Zugprüfmaschinen bis 2.5 kN (250 kg) für das Prüfen von Kabelverschraubungen, Steckdeckeln, Lampendübeln und anderen Komponenten. Ebenso der Klimaschrank für das Durchführen von Wärmealterungen, die Einrichtung für die Schlagprüfungen, mit der die Widerstandskategorie von Kabelverschraubungen ermittelt wird, und das Testgerät, mit dem die Glühdrahtfestigkeit an Bauteilen nach IEC (650°C / 850°C) geprüft wird.

Alles in allem kommen die Zulassungsstellen zu folgendem Schluss: „Die Produkte von AGRO halten, was das Unternehmen verspricht“.



Oil-Spray test

Wir verfügen ebenfalls über eigens konstruierte Prüfeinrichtungen, welche es uns erlauben, **nach der amerikanischen UL514B zu prüfen**. Dies beinhaltet den Oil-Spray, Flexing und pull-out Test sowie die Alterungsprüfung.

Ebenfalls im CTF-Verfahren führen wir Prüfungen und Zertifizierungen für Kabelverschraubungen durch, welche für den Einsatz in Explosionsgefährdeten Bereichen (Zündschutzart „e“ und „d“) zugelassen sind.

All dies erlaubt uns bereits in der Entwicklungsphase die Normvorschriften zu überprüfen und in die weitere Entwicklung mit einfließen zu lassen.

Darüber hinaus sind wir in den wichtigsten nationalen und internationalen Normengremien vertreten, damit wir aktiv die zukünftigen Normen mitgestalten können.

At the focus of testing

By successfully passing the tests by the accreditation bodies gives the consumer the assurance that the manufacturer of a product has the necessary normative knowledge and that the test equipment is suitable for carrying out tests according to official standards. The tests included the IP compression testing system (Protection Class IP X8 up to 10 MPa (100 bar) and tensile testing machines up to 2.5 kN (250 kg) for testing cable glands, plug-in covers, lamp plugs and other components. The same applies to the climatic chamber for carrying out heat ageing, the device for impact tests to determine the resistance category of cable glands, and the test device for testing the glow wire strength of components in accordance with IEC (650°C / 850°C).

All things considered, the accreditation bodies came to the conclusion that AGRO products perform just as the company promises.



Flexing test

AGRO has expanded its test laboratory with additional test set-ups and can now conduct oil-spray, flexing and pull-out tests as well as accelerated aging tests in accordance with the requirements of the **American UL 514B standard**.

We also carry out tests and certifications for cable glands in the CTF process, which are approved for use in potentially explosive atmospheres (ignition protection type “e” and “d”).

The ability to conduct in-house tests allows us to verify the non-conformity of new products early in the development stage. The development process can thus be faster and more efficient.

AGRO is represented in the most important national and international standardisation bodies and takes an active role in the design of future standards.

Für jede Sonderlösung richtig

The right choice for any special needs



Das AGRO Prüflabor

Unser hauseigenes Prüflabor ist nach CTF-Verfahren durch die Zulassungsstellen zertifiziert und garantiert die Qualität unserer Produkte. Es kann Tests durchführen, deren Resultate durch offizielle Zertifizierungsstellen wie etwa der Eurofins Electrosuisse, dem VDE oder den UL als Basis für die Ausstellung eines Zertifikates anerkannt werden.

The AGRO testing laboratory

Our in-house testing laboratory is certified according to CTF procedures by the accreditation bodies and guarantees the quality of our products. It can carry out tests, the results of which are recognised by official certification bodies such as Eurofins Electrosuisse, VDE or UL as the basis for an official certification.



Glühdrahtprüfung / Glow wire resistance



Schlagprüfung / Impact resistance



Oil Spray Test

Tests auch für Sie

Wenn ein Sonderteil normative Vorgaben erfüllen muss, so ist unser Prüflabor in der Lage, deren Einhaltung zu überprüfen - mit Ihrem individuellen Produkt und den effektiv eingesetzten Kabeln. Eine grösstmögliche Gewährleistung der Funktionssicherheit unter spezifischen Bedingungen kann so geboten werden.

Unser Prüflabor ist mit zeitgemässen Equipment ausgerüstet und kann folgende Tests durchführen:

- Wasserdruckfestigkeit
- Zugkraft
- Glühdrahtfestigkeit
- Querdruck
- Wärmealterung
- Wechselbiegefestigkeit
- Staubprüfung
- Klimatest
- Oil Spray Test
- Schlagprüfung
- etc.

We can also conduct testing for you

If a special part is required to comply with official standards or requirements, our testing laboratory can check its compliance - with your specific product and the cables that are to be used in practice. This ensures the greatest possible assurance of functional reliability under specific conditions.

Our testing laboratory is well equipped with up-to-date instruments and can carry out the following tests:

- Water pressure resistance
- Tensile strength
- Glow wire resistance
- Lateral pressure resistance
- Thermal ageing
- Flexural strength
- Dust test
- Climatic test
- Oil spray test
- Impact resistance
- etc.

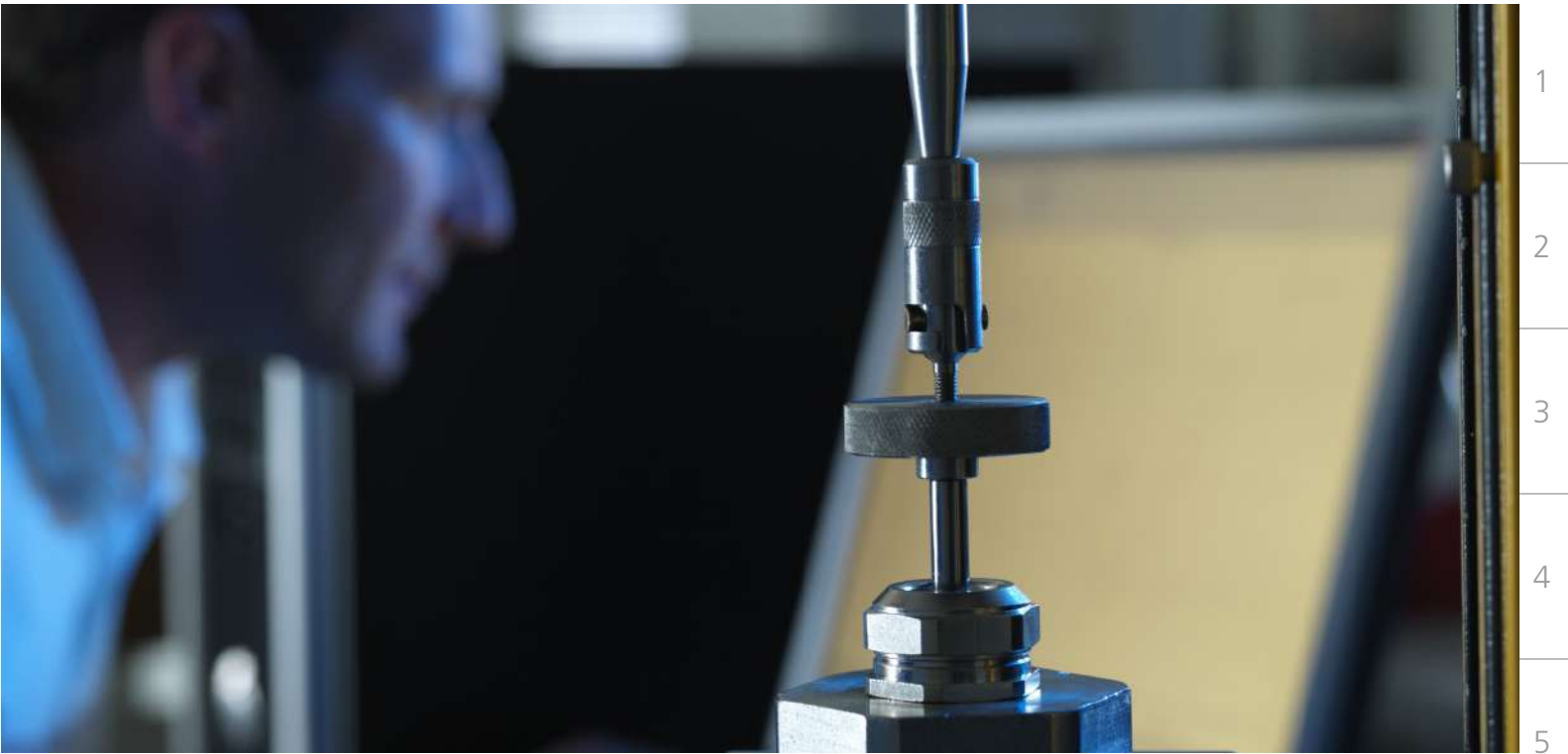

Die Ausgangslage

Für den Wagenübergang bei Zügen wurde eine Sonderlösung ausgearbeitet, bei der grosses Gewicht auf Vibrationssicherheit und schonende Kabelklemmung gelegt wurde. Der Dichteinsatz der Kabelverschraubung musste gemäss Anforderungen der EN 45545 ausgeführt sein.

The situation

A special solution needed to be worked out for the inter carriage transitions of a particular type of trains, in which great emphasis was placed on vibration resistance and especially protective cable clamping. The sealing insert of the cable gland required to be designed in accordance with of EN 45545.



Dichtheitsprüfung / Sealing test



Flexing Test



Zugprüfung / Tensile resistance

Prüfanordnung

Die Kabelverschraubung mit dem F-Dichteinsatz wurde als erstes mit dem Originalkabel einer Dichtheitsprüfung unterzogen, anschliessend wurde ebenfalls mit dem einzusetzenden Jumperkabel ein Flexingtest mit 500 Zyklen durchgeführt. Nach dieser Belastung wurde eine weitere Dichtheitsprüfung durchgeführt, um zu eruieren, ob - und falls ja - wie stark die Dichtleistung abgenommen hat. Zu guter Letzt wurde mit der bereits belasteten Kabelverschraubung die maximale Auszugskraft ermittelt.

Nachdem die Kombination Kabelverschraubung-Kabel die Tests erfolgreich bestanden hat, kann der Kunde mit Zuversicht davon ausgehen, dass das ausgearbeitete Sonderteil im realen Einsatz seine Aufgabe langfristig lösen wird.

Test arrangement

A cable gland with an F-type sealing insert was first subjected to a sealing test, using the original cable. Then a 500-cycle flexing test was carried out using the proposed jumper cable. After this loading, a further sealing test was carried out to determine whether - and if so, by how much - the sealing performance had decreased.

Finally, the maximum pull-out force was determined using the already loaded cable gland.

After the cable gland / cable combination had successfully passed the tests, the customer could have confidence that the special part as developed will provide good, reliable long-term performance.

1
2
3
4
5
6
7
8
9
10
11

Sonderlösung für very heavy duty

Special solution for "very heavy duty" application

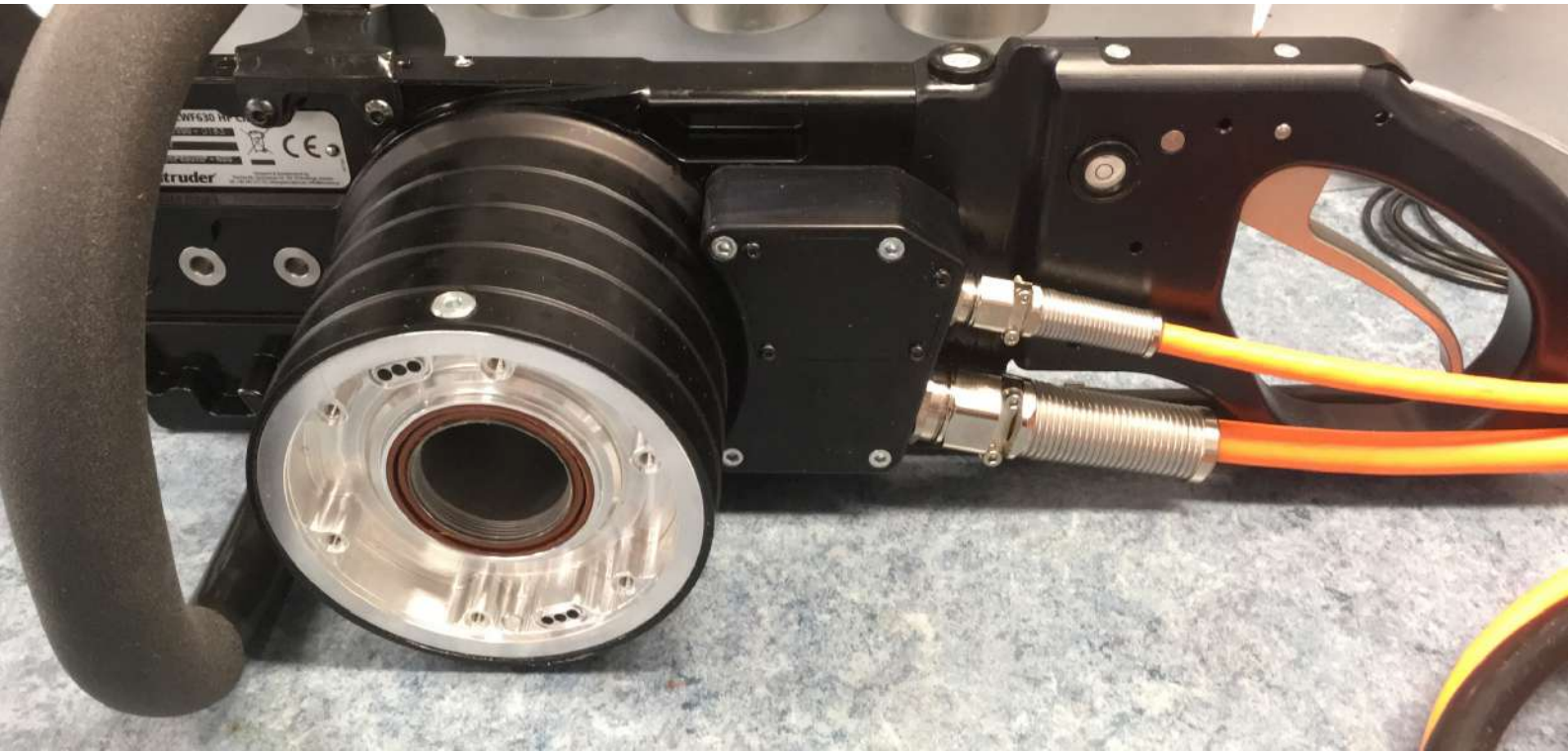

Die Ausgangslage

Betonbearbeitungsmaschinen müssen viel aushalten können. Sowohl Wasser als auch Steinschlag darf ihnen nichts anhaben können. Kabeleintrittsstellen sind besonders gefährdet.

Die Anforderungen

Die Kabel sollten durch einen Knickschutz vor Überbelastung geschützt und im gleichen Zug verhindert werden, dass Kabel ausreißen können. Gleichzeitig sollte ein EMV-Abgriff bei der Eintrittsstelle erfolgen.



Progress® mit Knickschutzfeder und Klemmbaken / with antikink spring and clamps

Die Lösung von AGRO

Die Standard EMV Kabelverschraubung mit Knickschutzfeder mit gewendelter Edelstahlfeder bildet die Basis der Lösung. Sie fängt selbst hohe dynamische Biegebelastungen sicher am Kabeleintritt ab und sorgt dafür, dass das Kabel vor Quetschen und Abknicken geschützt ist. Mit den zusätzlich integrierten Klemmbaken wird eine sehr hohe Zugentlastung erreicht, die verhindert, dass das Kabel ausgerissen wird und gewährleistet, dass die EMV-Schirmkontaktierung trotz dynamischer Belastung sicher bleibt.

The situation

Construction equipment for concrete must be able to withstand a great deal. They should not be damaged by water or stone impacts. Cable entry points are particularly vulnerable.

The requirements

Cables required to be protected against kinking while also being prevented from pulling out of the enclosure. An EMC grip was required at the entry point.



Betonsägemaschine / Concrete saw

The AGRO solution

The solution is based on the standard EMC cable gland with antikink protection from a spiral stainless-steel spring. It safely absorbs even high dynamic bending loads at the cable entry point, and protects the cable against crushing and buckling. With the additionally integrated clamping jaws, a very high degree of strain relief is achieved, which prevents the cable from being pulled out and ensures that the EMC braiding contact remains secure despite the dynamic loading.

Montageanleitung für Kabelverschraubungen Progress® Assembly instruction cable glands Progress®

Das Unterteil der Kabelverschraubung in das entsprechende Gewinde einschrauben.



Screw the lower part of the cable gland into the corresponding thread.

Oder:

Das Unterteil der Kabelverschraubung in die vorhandene Eintrittsöffnung im Gehäuse einführen und mittels Gegenmutter befestigen.

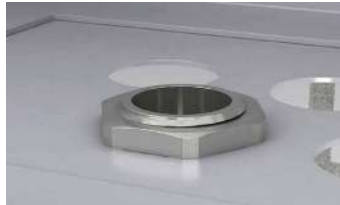

Put the lower part of the cable gland into an existing opening in the enclosure and fix it by means of a lock nut.

Wenn bei zweiteiligen Dichteinsätzen der Kabeldurchmesser das obere Ende des Klemmbereiches der Kabelverschraubung erreicht, muss der innere Teil des Dichteinsatzes entfernt werden.



Remove the inner part of the two-piece sealing insert, in case the cable diameter is close to the upper end of the clamping range of the cable gland.

Kabel, Dichteinsatz und Druckmutter in das Unterteil einführen, Druckmutter von Hand leicht verschrauben.



Insert the cable, sealing insert and the compression nut into the lower part of the cable gland and manually tighten the compression nut.

Druckmutter mit passendem Gabelschlüssel anziehen bis der Dichteinsatz zwischen Druckmutter und Kabel einen kleinen Wulst bildet.



Tighten the compression nut by means of a spanner until the sealing insert forms a small bead between the compression nut and the cable.

1

2

3

4

5

6

7

8

9

10

11

12

Progress® EMC easyCONNECT brass

Kontaktfeder aus dem Unterteil der Kabelverschraubung entfernen.

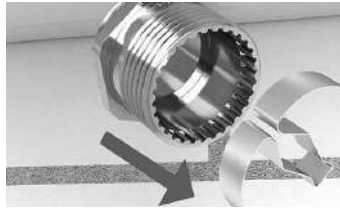

Remove the contact spring from the lower part of the cable gland.

Das Unterteil der Kabelverschraubung in das entsprechende Gewinde einschrauben oder in die vorhandene Eintrittsöffnung im Gehäuse einführen und mittels Gegenmutter befestigen.



Screw the lower part of the cable gland into the corresponding thread or put it into an existing opening in the enclosure and fix it by means of a lock nut.

Kabel abisolieren.



Strip the cable.

Kontaktfeder auf den Kabelschirm aufsetzen.



Clip the contact spring on the shielded cable.

Wenn bei zweiteiligen Dichteinsätzen der Kabeldurchmesser das obere Ende des Klemmbereiches der Kabelverschraubung erreicht, muss der innere Teil des Dichteinsatzes entfernt werden.



Remove the inner part of the two-piece sealing insert, in case the cable diameter is close to the upper end of the clamping range of the cable gland.

Kabel, Kontaktfeder, Dichteinsatz und Druckmutter in das Unterteil einführen, Druckmutter von Hand leicht verschrauben.



Insert cable, contact spring, sealing insert and the compression nut into the lower part of the cable gland and manually tighten the compression nut.

Druckmutter mit passendem Gabelschlüssel anziehen bis der Dichteinsatz zwischen Druckmutter und Kabel einen kleinen Wulst bildet.



Tighten the compression nut by means of a spanner until the sealing insert forms a small bead between the compression nut and the cable.



Über diesen QR Code erhalten Sie den Zugang zum Montagefilm Progress® EMV easyCONNECT Messing.

By activating this QR Code, you will get access to our installation movie Progress® EMC easyCONNECT nickel-plated brass.



Progress® EMV powerCONNECT Messing Progress® EMC powerCONNECT brass

Kabel vorbereiten, empfohlene Schirmlänge gemäss Tabelle.

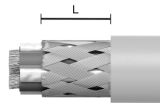

M16	13 mm +
M20	14 mm +
M25	15 mm +
M32	17 mm +
M40	18 mm +
M50/63	20 mm +
M75/80/85	22 mm +

Prepare cable, consult table for recommended shield length.

Bauteile auf Kabel aufreihen.
ACHTUNG - Einbau Presshülse.

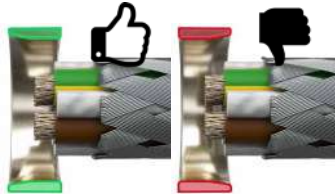

Line up components on the cable.
ATTENTION - compression sleeve.

Kabel in Unterteil einführen und Geflecht über Konus stülpen.



Insert the cable into the base part and pull the braiding over the cone.

Presshülse über Geflecht in Konus schieben.



Push the compression sleeve into the cone moving it over the braiding.

Zwischenstück (mit Dichteinsatz als Zentrierhilfe) aufschrauben und bis auf Block festdrehen.



Screw on the intermediate piece (with the sealing insert as a centring aid) and tighten it fully.

Druckmutter auf Zwischenstück schieben und mit Werkzeug anziehen.



Place pressure nut onto the intermediate piece and tighten with tool.



Montageanleitung

Assembly Instructions

Progress® EMV RAPID

- 1 Komplette Kabelverschraubung (5 Teile) in das vorgesehene Gehäuse einschrauben, ohne die Druckmutter fester anzuziehen.
- 2 Kabelaussenmantel partiell abisolieren oder auf gewünschte Länge zuschneiden.
- 3 Kabel in die Kabelverschraubung einführen, bis der Schirm in der Kontaktscheibe (5) einrastet oder der Kabelmantel an der Scheibe ansteht.
- 4 Druckmutter (1) mit dem Unterteil (4) verschrauben, bis der Dichteinsatz (2) zwischen Druckmutter und Kabel einen kleinen Wulst bildet.

FERTIG!

Die PROGRESS MS EMV RAPID kann durch Ausstossen der Kontaktscheibe (5) auch ohne Weiterführen des Schirms montiert werden. Weitere Informationen dazu in der Montageanleitung der PROGRESS EMV oder dem Montagevideo auf unserer Webseite www.agro.ch.

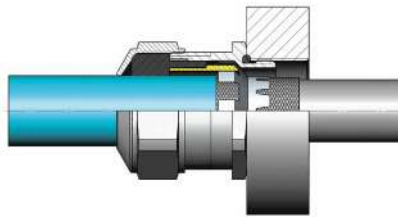
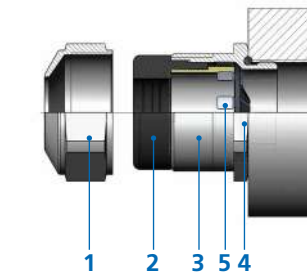

Progress® EMV RAPID

- 1 Screw in the complete cable gland (5 parts) into the intended housing without further tightening the compression nut.
- 2 Partially dismantle the outer cable sleeve or trim to the desired length.
- 3 Feed cable into the cable gland until the shielding snaps into the contact disk (5) or the cable sheath contacts the disc.
- 4 Tighten compression nut (1) to the lower gland part (4) until the sealing insert (2) forms a small ridge between the compression nut and the cable.

FINISHED!

The PROGRESS MS EMV RAPID can also be mounted by extruding the contact disc (5) without extending the shield. See the PROGRESS EMV assembly instructions.

Progress® EMV

- 1 Unterteil (4) der Kabelverschraubung in das vorgesehene Gehäuse einschrauben.
- 2 Druckmutter (1), Dichteinsatz (2) und Kontakthülse (3) über das Kabel ziehen.
- 3 Aussenmantel des Kabels auf die gewünschte Länge zurückschneiden.
- 4 Schirmumflechtung oder Schirmfolie ungefähr auf Kontakthülslänge X zuschneiden.
- 5 Kontakthülse, Dichteinsatz und Druckmutter bis Mantelende vorschieben.
- 6 Schirmgeflecht (6) oder Schirmfolie über Kontakthülse legen und überstehendes Schirmmaterial abschneiden.
- 7 Kabel durch das bereits montierte Unterteil der Kabelverschraubung führen.
- 8 Dichteinsatz und Kontakthülse bündig in das Unterteil stecken.
- 9 Druckmutter mit dem Unterteil verschrauben, bis der Dichteinsatz zwischen Druckmutter und Kabel einen kleinen Wulst bildet.

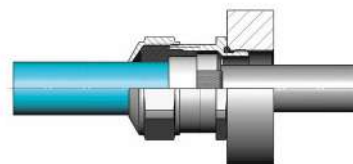
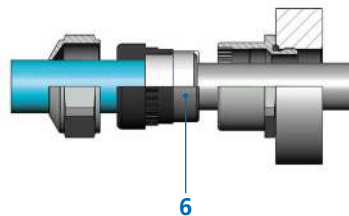
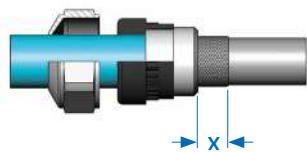
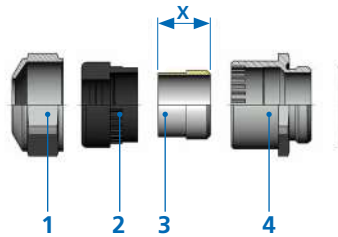

Progress® EMV

- 1 Screw the lower part (4) of the cable gland into the housing.
- 2 Push compression nut (1), sealing insert (2) and contact bushing (3) over the cable.
- 3 Trim outer sheath of the cable to the desired length.
- 4 Trim braided shield or shielding foil to the approximate length of contact bushing X.
- 5 Push contact bushing, sealing insert and compression nut to the end of the sheath.
- 6 Place braided shield (6) or shielding foil over the contact bushing and cut off the protruding shielding material.
- 7 Feed cable through the already mounted lower part of the cable gland.
- 8 Insert sealing insert and contact bushing flush into the lower part.
- 9 Tighten compression nut to the lower part until the sealing insert forms a small ridge between the compression nut and the cable.

Progress® EMV Serie 85

1 Den Kabelmantel und Kabelschirm mit einer Schere sauber auf die gewünschte Länge zurückschneiden, wenn der Kabelschirm nicht weiter geführt werden muss.

Um den Kabelschirm optimal zu schützen, ist es erforderlich, dass der Lieferung beiliegende Kupfer-EMV-Tape (Kupferklebeband 25 mm, Scotch 3M Typ 1181) zu montieren.

2 Das Unterteil (Pos. 5) der Kabelverschraubung in das vorgesehene Gehäuse einschrauben, Druckmutter (Pos. 1), Dichteinsatz (Pos. 2), Zwischenstück (Pos. 4) und Spannzange (Pos. 3) über das Kabel aufschieben. Kabel mit der Spannzange in das Unterteil einführen und positionieren.

3 Zwischenstück mit dem Unterteil verschrauben, bis das Kabel fühlbar geklemmt wird, anschließend gemäss unten stehender Tabelle festziehen.

4 Druckmutter mit dem Zwischenstück (Zwischenstück mit Schlüssel kontern) verschrauben, bis der Dichteinsatz zwischen Druckmutter und Kabel einen kleinen Wulst bildet.

Die Montage sollte nur durch geschultes Fachpersonal durchgeführt werden.

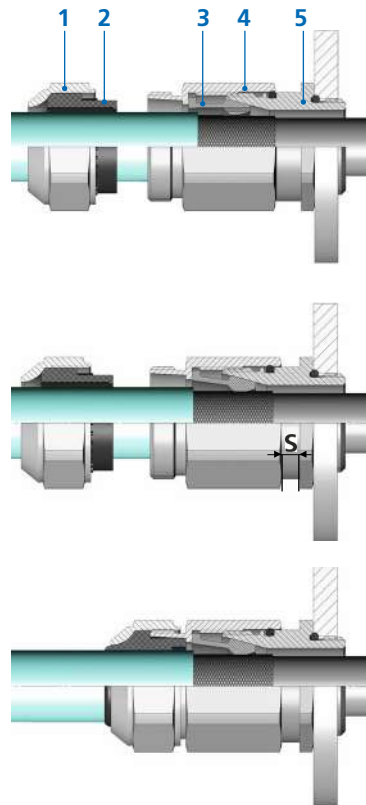

Progress® EMC Series 85

1 Trim the outer cable sheath and cable shield neatly to the desired length using a cutter if the cable shield need not be continued.

To provide the best possible protection for the cable shield, it is necessary to install a copper EMC tape (copper adhesive tape 25 mm wide, Scotch 3M type 1181).

2 Screw the lower section (item 5) of the cable gland into the housing. Push the compression nut (item 1), sealing insert (item 2), adapter (item 4) and collet (item 3) over the cable. Use the collet to introduce and position the cable in the lower section.

3 Screw the adapter onto the lower section until the cable becomes clamped, then tighten according to the table below.

4 Screw the compression nut onto the adapter (tighten the adapter using a spanner) until the sealing insert forms a small ridge between the compression nut and the cable.

Installation should only be carried out by trained experts.

Das Kupfer-Tape muss zwingend gemäss Illustration montiert werden! Klebeschuttfolie vorgängig entfernen.

The copper tape must be fixed according to the illustration! Remove protection film first.

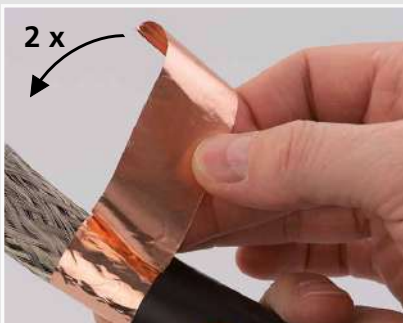

Tape Scotch 3M Typ 1181



Hilfstabelle zur optimalen Schirmkontaktierung

Die Angaben dienen als Arbeitshilfe und ermöglichen eine fachgerechte Montage der Kabelverschraubung Progress EMV Serie 85. Die Richtwerte sind unverbindlich.

Information Table for Optimum Shield Contact

The information is provided as a work instruction and facilitates professional installation of the Progress EMC Series 85 cable gland. The reference values are non-binding.

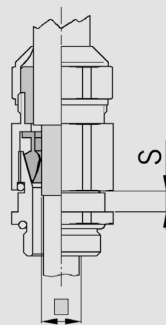

1000.17.85.045	3.0 - 4.0	0
	4.0 - 4.5	1.0
1000.17.85.080	4.5 - 6.0	0
	6.0 - 8.0	1.5
1000.17.85.100	7.5 - 10.0	0
	7.5 - 10.0	0
1000.20.85.120	10.0 - 12.0	1.5
1000.20.85.140	10.0 - 12.0	0
	12.0 - 14.0	1.5
1000.25.85.160	10.0 - 13.0	0
	13.0 - 16.0	2.0
1000.25.85.190	14.0 - 16.5	0
	16.5 - 19.0	2.0
1000.32.85.220	14.0 - 18.0	0
	18.0 - 22.0	3.0
1000.32.85.250	21.0 - 23.0	0
	23.0 - 25.0	2.0
1000.40.85.300	21.0 - 25.5	0
	25.5 - 30.0	3.0
1000.50.85.380	29.0 - 33.5	0
	33.5 - 38.0	3.0
1000.63.85.380	29.0 - 33.5	0
	33.5 - 38.0	3.0
1000.63.85.440	35.0 - 39.5	0.5
	39.5 - 44.0	3.0

Masse für Gewinde und Bohrlöcher

Dimensions of threads and drilled holes

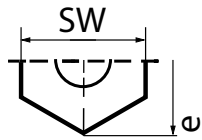



Ermittlung der Eckmasse „e“

6-Kant:
 $e = 1.155 \times SW$ (Schlüsselweite)

Determinatin of the width accross corners „e“

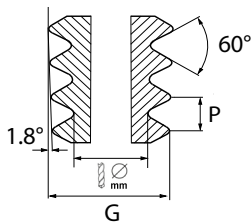
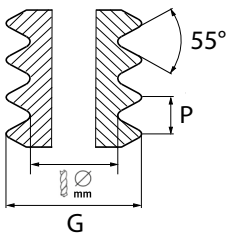
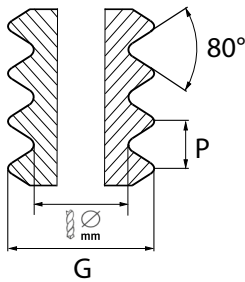
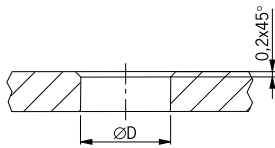
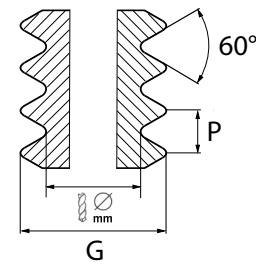
hexagon:
 $e = 1.155 \times SW$ (opening of the spanner)



	G	Steigung Pitch P	 mm	ØD mm
Metrisches Gewinde Metric thread				
M6x1.0 ¹⁾	6.00	1.00	5.00	6.0
M6x0.75 ²⁾	6.00	0.75	5.25	6.0
M8x1.25 ¹⁾	8.00	1.25	6.75	8.0
M8x1.0 ²⁾	8.00	1.00	7.00	8.0
M10x1.5 ¹⁾	10.00	1.50	8.50	10.0
M10x1.0 ²⁾	10.00	1.00	9.00	10.0
M12x1.5	12.00	1.50	10.50	12.0
M16x1.5	16.00	1.50	14.50	16.0
M20x1.5	20.00	1.50	18.50	20.0
M25x1.5	25.00	1.50	23.50	25.0
M32x1.5	32.00	1.50	30.50	32.0
M40x1.5	40.00	1.50	38.50	40.2
M50x1.5	50.00	1.50	48.50	50.2
M63x1.5	63.00	1.50	61.50	63.2
M75x1.5	75.00	1.50	73.50	75.2
M80x1.5	80.00	1.50	78.50	80.2
M85x2.0	85.00	2.00	83.00	85.2
M95x2.0	95.00	2.00	93.00	95.2
M100x3.0	100.00	3.00	97.00	100.2
M105x3.0	105.00	3.00	102.00	105.2
M115x3.0	115.00	3.00	112.00	115.2
Pg - Gewinde Thread Pg				
Pg 7	12.50	1.27	11.40	12.6
Pg 9	15.20	1.41	14.00	15.3
Pg 11	18.60	1.41	17.25	18.7
Pg 13	20.40	1.41	19.00	20.5
Pg 16	22.50	1.41	21.25	22.6
Pg 21	28.30	1.58	26.75	28.4
Pg 29	37.00	1.58	35.50	37.2
Pg 36	47.00	1.58	45.50	47.2
Pg 42	54.00	1.58	52.50	54.2
Pg 48	59.30	1.58	57.80	59.5
Gasrohr-Gewinde Gas-pipe thread				
G 1/4"	13.15	1.33	11.60	13.3
G 3/8"	16.66	1.33	15.00	16.8
G 1/2"	20.95	1.81	19.00	21.0
G 5/8"	22.91	1.81	21.00	23.0
G 3/4"	26.44	1.81	24.60	26.5
G 1"	33.25	2.30	30.50	33.5
G 1 1/4"	41.91	2.30	39.50	42.2
G 1 1/2"	47.80	2.30	45.00	48.0
G 2"	59.61	2.30	57.00	60.0
G 2 1/2"	75.18	2.30	72.50	75.5
G 3"	87.88	2.30	84.50	88.0
G 4"	113.03	2.30	110.50	113.5
G 5"	138.43	2.30	136.00	139.0
NPT-Gewinde NPT Thread				
NPT 1/8"	10.29	0.94	8.43	
NPT 1/7"	13.72	1.41	11.13	
NPT 3/8"	17.14	1.41	14.27	
NPT 1/2"	21.34	1.81	17.86	
NPT 3/4"	26.67	1.81	23.28	
NPT 1"	33.40	2.20	28.98	
NPT 1 1/4"	42.16	2.20	37.69	
NPT 1 1/2"	48.26	2.20	43.66	
NPT 2"	60.32	2.20	55.58	

1) Metrisches Regelgewinde
 2) Metrisches Gewinde nach EN60423





1) metric coarse pitch thread
 2) metric thread acc. to EN 60423

1. Ziffer:

Schutzgrad für Berührungs- und Fremdkörperschutz

1st figure:

Degree of protection against touching and foreign matters









Prüfungen / Specifications	
IP 0x	Kein Schutz No protection
IP 1x 	Schutz gegen Eindringen von festen Fremdkörpern grösser als 50 mm (unbeabsichtigtes Berühren mit der Hand) Protection against penetration by solid foreign matters larger than 50 mm (accidental touching by hand)
IP 2x 	Schutz gegen Eindringen von festen Fremdkörpern grösser als 12 mm (unbeabsichtigtes Berühren mit den Fingern) Protection against penetration by solid foreign matters larger than 12 mm (touching with fingers)
IP 3x 	Schutz gegen Eindringen von festen Fremdkörpern grösser als 2.5 mm (unbeabsichtigtes Berühren mit Werkzeugen, Drähten usw., dicker als 2.5mm) Protection against penetration by solid foreign matters larger than 2.5 mm (touching with tools, wires etc. larger than 2.5 mm)
IP 4x 	Schutz gegen Eindringen von festen Fremdkörpern grösser als 1 mm (Berühren mit Werkzeugen, Drähten usw., dicker als 1 mm) Protection against penetration by solid foreign matters larger than 1 mm (touching with tools, wires etc. larger than 1 mm)
IP 5x 	Vollständiger Schutz gegen Berühren, Schutz gegen schädliche Staubablagerung – Eindringen von Staub wird nicht vollkommen verhindert Complete protection from being touched. Protection from harmful dust deposits - dust penetration is not completely prevented
IP 6x 	Vollständiger Schutz gegen Berühren, Schutz gegen Eindringen von Staub Complete protection from being touched. Protection against penetration by dust.

2. Ziffer:

Schutzgrad für Wasserschutz

2nd figure:

Degree of protection against water

Prüfungen / Specifications	
IP x0	Kein Schutz No protection
IP x1 	Senkrecht fallende Tropfen dürfen keine schädigende Wirkung haben Dripping water (vertically falling drops) shall have no harmful effect
IP x2 	Senkrecht fallende Tropfen dürfen keine schädigende Wirkung haben, wenn das Gehäuse um einen Winkel von bis zu 15° beiderseits der Senkrechten geneigt ist Vertically dripping water shall have no harmful effect when the enclosure is tilted at an angle up to 15° from its normal position
IP x3 	Wasser, das in einem Winkel bis zu 60° beiderseits der Senkrechten gesprüht wird, darf keine schädliche Wirkung haben Water falling as a spray at any angle up to 60° from the vertical shall have no harmful effect
IP x4 	Wasser, das aus jeder Richtung gegen das Gehäuse spritzt, darf keine schädliche Wirkung haben Water splashing against the enclosure from any direction shall have no harmful effect
IP x5 	Wasser, das aus jeder Richtung als Strahl gegen das Gehäuse gerichtet ist, darf keine schädliche Wirkung haben Water projected by a nozzle against enclosure from any direction shall have no harmful effects
IP x6 	Wasser, das aus jeder Richtung als starker Strahl gegen das Gehäuse spritzt, darf keine schädliche Wirkung haben Water projected in powerful jets against the enclosure from any direction shall have no harmful effects
IP x7 	Wasser darf nicht in einer Menge eintreten, die schädliche Wirkungen verursacht, wenn das Gehäuse unter genormten Druck- und Zeitbedingungen zeitweilig in Wasser getaucht ist Ingress of water in harmful quantity shall not be possible when the enclosure is immersed in water under defined conditions of pressure and time
IP x8 	Wasser darf nicht in einer Menge eintreten, die schädliche Wirkungen verursacht, wenn das Gehäuse dauernd unter Wasser getaucht ist unter Bedingungen, die zwischen Hersteller und Anwender vereinbart werden müssen; Die Bedingungen müssen jedoch schwieriger sein als für Kennziffer 7 The equipment is suitable for continuous immersion in water under conditions which shall be specified by the manufacturer The requirements must be more demanding than the ones of code number 7
IP x9	Schutz gegen Eindringen von Wasser unter Hochdruck (80-100 bar) mit einer Temperatur bis 80°C (Dampfstrahlreinigung) Protection against the penetration of water during high-pressure (80 - 100 bars), high-temperature wash-down applications (80°C)

1
2
3
4
5
6
7
8
9
10
11
12

Materialübersichtstabelle – Metalle

List of materials – Metals

Produkt Product	Messing vernickelt Nickel-plated brass	Stahl A2 Stainless steel A2	A4 Stainless steel A4	Aluminium Aluminum
	CuZn39Pb3	X10CrNiS 18 9 DIN 1.4305/AISI 303	X2CrNiMo 18 14 3 DIN 1.4435/AISI 316 L	AlMgSi0.5 DIN 3.3206
Bezeichnung	Kupfer/Zinklegierung Oberfläche galvanisch vernickelt	Rostbeständiger Stahl	Rost- und säurebestän- diger Stahl	Aluminium
Designation	Copper/zinc alloy surface galvanically nickel-plated	Stainless steel	Acid-resistant stainless steel	Aluminum
Korrosionsverhalten Chem. Beständigkeit	Gut beständig in trockener Atmosphäre, Süsswasser, Wasser- dampf, Mineralölen, Kraftstoffen, Kühl-/ Schmierstoffen und vielen organischen Emul- sionen	Gut beständig gegen verdünnte organische und oxidierende Säuren, Laugen, neutrale und alkalische Salzlösungen sowie organische Verbin- dungen	Hat gute Beständig- keit gegen organische Säuren, z.B. Zitronen- Milch-, Ameisen-, Wein- und Essigsäure, bei hoher Konzentra- tion und Temperatur. Anorganische Säuren, z.B. Bor-Phosphor- und Salpetersäure sowie schweflige Säure, bei mässiger Konzentration und Temperatur.	Gut beständig in trockener Atmosphäre, Mineralölen, Kraftstoffen
Corrodibility Chemical resistance	High resistance in dry atmosphere, freshwater, against water vapour, mineral oil, motor fuels, cooling and lubricating liquids and against many other organic emulsions	High resistance against diluted organic and oxidizing acids, alkaline solutions, neutral and alkaline saline solutions, as well as against organic compounds	Good resistance against organic acids such as citric, lactic, formic and ethanoic acid as well as acidity of wine in high concentration and temperatu-res. Good resistance against inorganic acids such as boron -phosphoric acid, nitric acid and sulphu- rous acids in moderate concentration and tem- perature	High resistance in dry atmosphere. Resistance against most mineral oils and motor fuels
Bedingt bzw. nicht beständig	Meer-, Brackwasser, feuchte Atmosphären, Säuren, Laugen, Chlori- de, Ammoniak	Anorganische Säuren, Halogene, Chloride und chloridhaltige Lösungen oder Atmosphären	Salzsäure, Halogene, Chloride und chlorid- haltige Lösungen oder Atmosphären	Süss-, Meer-, Brackwas- ser, feuchte Atmosphä- ren, Säuren, Laugen
Non- or partial resi- stance only	Seawater, brackwater, humid atmosphere, acids, alkaline solutions, chlorides, ammonia	Inorganic acids, halogen, chlorides and chlorid containing solutions or atmospheres	Hydrochloric acid, halo- gen, chlorides and chlo- rid containing solutions or atmospheres	Freshwater, sea- and brackwater, humid at- mosphere, acids, alkaline solutions
Witterungsbeständig- keit	Sehr gute Witterungs- und Alterungsbestän- digkeit	Sehr gute Witterungs- und Alterungsbestän- digkeit	Sehr gute Witterungs- und Alterungsbestän- digkeit	Gute Witterungs- und Alterungsbeständigkeit
Weather resistance	Very good weather and non-ageing resistance	Very good weather and non-ageing resistance	Very good weather and non-ageing resistance	Good weather and non- ageing resistance
Thermische Werte dauernd				
Permanent thermal conditions	-60°/+200°	-60°/+400°	-60°/+400°	-60°/+200°
Brennbarkeit	Nicht brennbar	Nicht brennbar	Nicht brennbar	Nicht brennbar
Combustibility	Non-combustible	Non-combustible	Non-combustible	Non-combustible

Bei speziellen Anwendungen bitten wir um Ihre schriftliche Anfrage.

In case of special applications, we kindly ask you to send us your written request.

Produkt / Product	Agromid	PA GFK	PA	Polyester
Bezeichnung	Polyamid PA6 GF30, glasfaserverstärkt, schlagzäh, wärmestabilisiert	Polyamid PA6 GF30, glasfaserverstärkt	Polyamid PA6	
Designation	Polyamide PA6 GF30, glass-fiber reinforced, impact resistant, heat-stabilized	Polyamide PA6 GF30, glass-fibre reinforced	Polyamide PA6	Polyester PET
Farbe Colour	Nach Katalog See catalogue	Nach Katalog See catalogue	Nach Katalog See catalogue	Nach Katalog See catalogue
Korrosionsverhalten Chem. Beständigkeit	Beständig gegen verdünnte organische Säuren, Laugen, wässrige Lösungen von anorganischen Salzen, Mineralöle, Kraftstoffe, Kühl- und Schneideöle			gute Beständigkeit gegen Wasser (bei Raumtemperatur), verdünnte Säuren, neutrale und saure Salze, Alkohol, Ether, Öle, Fette, perchlorierte und aromatische Kohlenwasserstoffe
Corrodibility Chemical resistance	Resistant against organic diluted acids, alkaline solutions, diluted inorganic saline solutions, mineral oils, motor fuels, cooling and cutting oils			good resistance to water (room temperature), diluted acids, neutral and acid salts, alcohol, ether, oils, greases, perchlorinated and aromatic hydrocarbons
Bedingt bzw. nicht beständig	Mineralsäuren, konzentrierte organische Säuren, Ameisensäure, Phenole, Halogene			Alkalien, überhitzten Dampf, Ketone, Phenole, Ester, oxidierende Säuren und Kohlenwasserstoffe, Ammoniak
Non- or partial resistance only	Mineral acids, concentrated organic acids, formic acids, phenols, halogens			Alkalins, superheated steam, ketones, phenols, esters, oxidising acids and hydrocarbons, ammonia
Witterungsbeständigkeit	Gute Witterungs- und Alterungsbeständigkeit	Gute Witterungsbeständigkeit	Gute Witterungsbeständigkeit, in schwarz UV-beständig (getestet nach EN ISO 4892-2)	Gute Witterungsbeständigkeit
Weather resistance	Good weather and non-ageing resistance	Good weather resistance	Good weather resistance, in black UV-resistant (tested according to EN ISO 4892-2)	Good weather resistance
Thermische Werte dauernd Permanent thermal conditions	-30°/+120°C	-20°/+100°C	-30°/+100°C	-50°C/+150°C
Brennbarkeit Combustibility	vergleichbar UL 94 HB halogenfrei comparable UL 94 HB halogen free	vergleichbar UL 94 HB halogenfrei comparable UL 94 HB halogen free	UL 94 V-2 halogenfrei UL 94 V-2 halogen free	EN 45545-2 (HL3) halogenfrei EN 45545-2 (HL3) halogen free

Bei speziellen Anwendungen bitten wir um Ihre schriftliche Anfrage.

In case of special applications, we kindly ask you to send us your written request.

Materialübersichtstabelle – Elastomere

List of materials – Elastomeric materials

Produkt / Product	TPE	Spezial/Special TPE	NBR	FPM
Bezeichnung	Thermoplastisches Elastomer	Thermoplastisches Elastomer, Spezial Compound	Acrylnitril-Butadien-Kautschuk	Fluor-Kautschuk
Designation	Thermoplastic elastomere	Thermoplastic elastomere, special compound	Acrylonitrile-butadiene caoutchouc	Fluorine-caoutchouc
Farbe Colour	Schwarz Black	Hellgrau RAL 7035 Light grey RAL 7035	Schwarz Black	Grün Green
Korrosionsverhalten Chem. Beständigkeit	Beständig gegen verdünnte Säuren und Laugen, wässrige Lösungen von anorganischen Salzen	Gut beständig gegen verdünnte Säuren und Laugen, wässrige Lösungen von anorganischen Salzen, Heisswasser sowie Meerwasser	Beständig gegen verdünnte Säuren und Laugen, wässrige Lösungen von anorganischen Salzen, Mineralöle, Kraftstoffe, Kühl- und Schneidöle	Beständig gegen die meisten Säuren und Laugen, wässrige Lösungen von anorganischen Salzen, Mineralöle, Kraftstoffe, Kühl- und Schneidöle
Corrodibility Chemical resistance	Resistant against diluted acids and alkaline solutions, against diluted inorganic saline solutions	High resistance against diluted inorganic saline solutions, against diluted acids and alkaline solutions, hotwater as well as seawater.	Resistant against diluted acids and alkaline solutions, against diluted inorganic saline solutions, mineral oils, motor fuels, cooling and cutting oils	Resistant against most acids and alkaline solutions, against diluted inorganic saline solutions, mineral oils, motor fuels, cooling and cutting oils
Bedingt bzw. nicht beständig	Konzentrierte Säuren und Laugen, Lösungsmittel, Kraftstoffe, Mineral-, Kühl- und Schneidöle	Nicht beständig gegen konzentrierte Säuren und Laugen, Lösungsmittel und Kraftstoffe	Konzentrierte Säuren und Laugen, Lösungsmittel, Ozon	Konzentrierte Laugen
Non- or partial resistance only	Concentrated acids and alkaline solutions, solvents, motor fuels, mineral, cooling and cutting oils	Non resistant to motor fuels, solvents, concentrated acids and alkaline solutions.	Concentrated acids and alkaline solutions, solvents, ozone	Concentrated alkaline solutions
Witterungsbeständigkeit	Gute Witterungs-, Ozon- und Alterungsbeständigkeit	Gute Witterungs-, Ozon- und Alterungsbeständigkeit	Gute Witterungsbeständigkeit	Sehr gute Witterungs-, Ozon- und Alterungsbeständigkeit
Weather resistance	Good weather-, ozone and non-ageing resistance	Good weather-, ozone and non-ageing resistance	Good weather resistance	Very good weather-, ozone and non-ageing resistance
Thermische Werte dauernd Permanent thermal conditions	-40°/+100° - 60° (Ex)	-50°C/+105°C	-40°/+100° -60° (Ex)	-40°/+200°
Brennbarkeit	UL94 HB halogenfrei	EN 45545-2 / HL3 EN 45545-3 / E30	vergleichbar UL94 HB halogenfrei	vergleichbar UL94 V-2
Combustibility	UL 94 HB halogenfree	UL94 V0	comparable UL 94 HB halogenfree	comparable UL 94 V-2 comparable à

Bei speziellen Anwendungen bitten wir um Ihre schriftliche Anfrage.

In case of special applications, we kindly ask you to send us your written request. In case of special applications, we kindly ask you to send us your written request.

Produkt / Product	FKM	EPDM	CR
Bezeichnung Designation	Fluor-Kautschuk Fluorine-caoutchouc	Ethylen-Propylen-Terpolymere-Kautschuk Ethylene-Propylene-diene rubber	Chloropren-Kautschuk Chloroprene-caoutchouc
Farbe Colour	Blau blue	Nach Katalog See catalogue	Schwarz Black
Korrosionsverhalten Chem. Beständigkeit	Beständig gegen die meisten Säuren und Laugen, wässrige Lösungen von anorganischen Salzen, Mineralöle, Kraftstoffe, Kühl- und Schneidöle FDA konform	Heisswasser, wässrige Lösungen von anorganischen Salzen, verdünnte Säuren und Laugen	Beständig gegen verdünnte Säuren und Laugen, wässrige Lösungen von anorganischen Salzen, Mineral-, Kühl- und Schneidöle
Corrodibility Chemical resistance	Resistant against most acids and alkaline solutions, against diluted inorganic saline solutions, mineral oils, motor fuels, cooling and cutting oils. In conformity with FDA requirements.	Hot water, diluted inorganic solutions, diluted acids and alkaline solutions	Resistant against diluted acids and alkaline solutions, against diluted inorganic saline solutions, mineral oils, cooling and cutting oils
Bedingt bzw. nicht beständig Non- or partial resistance only	Konzentrierte Laugen Concentrated alkaline solutions	Mineralöle, Kraft- und Treibstoffe, konzentrierte Säuren und Laugen, Ester Mineral oils, motor fuels, concentrated acids and alkaline solutions, ester	Konzentrierte Säuren und Laugen, Lösungsmittel, Kraftstoffe, Heisswasser, Ozon Concentrated acids and alkaline solutions, motor fuels, solvents, hotwater, ozone
Witterungsbeständigkeit Weather resistance	Sehr gute Witterungs-, Ozon- und Alterungsbeständigkeit Very good weather-, ozone and non-ageing resistance	Gute Witterungs-, Ozon- und Alterungsbeständigkeit Good weather, ozone and non-ageing resistance	Gute Witterungsbeständigkeit Good weather resistance
Thermische Werte dauernd Permanent thermal conditions	-40°C/+200°C	-40°/+110°C	-30°/+100°
Brennbarkeit Combustibility	vergleichbar UL94 V-2 comparable UL 94 V-2 halogen free	vergleichbar UL 94 HB halogenfrei comparable UL 94 HB halogen free	vergleichbar UL 94 HB comparable UL 94 HB

Bei speziellen Anwendungen bitten wir um Ihre schriftliche Anfrage.
In case of special applications, we kindly ask you to send us your written request.

Comparison of stainless and acid-resistant steel A4



Edelstahl Rostfrei ist der Sammelbegriff für nichtrostende Stähle, die sich durch besondere Beständigkeit gegen chemisch angreifende Stoffe auszeichnen. Sie haben einen Massenanteil von 10,5 % Chrom (Cr) und von höchstens 1,2 % Kohlenstoff (C). Ein höherer Chromgehalt und der Zusatz weiterer Legierungselemente wie Nickel (Ni), Molybdän (Mo), Mangan (Mn) und Kupfer (Cu) verbessern die Korrosionsstabilität, verändern aber auch die mechanischen Eigenschaften.

Wir vergleichen hier die beiden rostfreien und säurebeständigen Stähle DIN EN 1.4404 und DIN EN 1.4435. Beide sind eine beliebte Wahl für Kabelverschraubungen mit hohen Ansprüchen an die Korrosionsbeständigkeit.

Der von AGRO AG verwendete Stahl A4 mit der Werkstoffnummer DIN EN 1.4435 (AISI 316L) ist eine höher legierte Variante des DIN EN 1.4404. Er weist in natürlichen Umweltmedien wie Salzwasser, ländlichen und städtischen Atmosphären, in Industriegebieten mit gemässigten Chlor- und Salzkonzentrationen sowie im Bereich der Nahrungsmittelproduktion eine ausgezeichnete Korrosionsbeständigkeit auf. Aufgrund des höheren Chrom-, Nickel- und Molybdän-Anteils ist der DIN EN 1.4435 im Vergleich zu anderen A4 Stählen in der Säurebeständigkeit unübertroffen. Die signifikante Anwesenheit von Molybdän verbessert besonders die Beständigkeit gegen Chlorid, Schwefelsäure und organische Säuren.

Technische Daten

Stahl / Steel	C (%)	Cr (%)	Ni (%)	Mo (%)	Mn (%)	Cu (%)	Si (%)	P (%)	S (%)
DIN 1.4435 (AGRO) (AISI 316L)	≤ 0.030	17.0 - 19.0	12.5 - 15.0	2.5 - 3.5	≤ 2.0	0.11	≤ 1.0	≤ 0.045	≤ 0.015
DIN 1.4404 (AISI 316L)	≤ 0.03	16.5 - 18.5	10.0 - 13.0	2.0 - 2.5	≤ 2.0	0	≤ 1.0	≤ 0.045	≤ 0.015

Anwendungsgebiete

Der Werkstoff DIN EN 1.4435 kann sehr gut in chemischen Anlagen, für medizinischen Anwendungen, in der pharmazeutische Industrie, der Lebensmittelherstellung sowie der Vakuumtechnik eingesetzt werden. Dank seiner aussergewöhnlichen Korrosionsbeständigkeit ist dieser Stahl auch optimal für die Schwimmbadtechnik geeignet.

Stainless steel is a general term for non-rusting steels that are characterised by particularly good resistance against chemically aggressive substances. They contain minimum 10.5% chromium (Cr) by weight, and maximum 1.2% carbon (C). A higher chromium content and the addition of further alloying elements such as nickel (Ni), molybdenum (Mo), manganese (Mn) and copper (Cu) improve corrosion resistance, but also change the material's mechanical properties.

Here, we compare two rust- and acid-proof steels: DIN EN 1.4404 and DIN EN 1.4435. Both are widely used for cable glands with high demands in relation to corrosion resistance.

The A4 steel used by AGRO AG, with the material number DIN EN 1.4435 (AISI 316L), is a more highly alloyed variation of type DIN EN 1.4404. It exhibits excellent corrosion resistance in natural environmental media such as saltwater, in rural and urban atmospheres, in industrial areas with moderate concentrations of chlorine and salt, and in the field of food production. Due to its higher chromium, nickel and molybdenum contents, type DIN EN 1.4435 is unsurpassed by other A4 steels in terms of resistance to acids. The significant presence of molybdenum particularly improves the resistance to chlorides, sulphuric acid and organic acids.

Technical details

Application areas

The material DIN EN 1.4435 finds good application in chemical facilities, for medical uses, in the pharmaceutical industry, in food production and in vacuum technology. Thanks to its exceptional corrosion resistance, this type of steel is also ideally suited to use in swimming pool technology.

Art.-Nr. Art. No.	Seite Page	Art.-Nr. Art. No.	Seite Page	Art.-Nr. Art. No.	Seite Page	Art.-Nr. Art. No.	Seite Page	Art.-Nr. Art. No.	Seite Page
10...		1000.11.120	23	1000.1G	29	1000.3/4NPT.125	28	1000.48.98.30.03	230
1000.06.025	17	1000.11.20.30	38	1000.1NPT	28	1000.3/4NPT.160	28	1000.50	18
1000.06.030	17	1000.11.20.30.91	39	1000.1NPT.170	28	1000.3/4NPT.205	28	1000.50.00.08	231
1000.06.035	17	1000.11.30.03	230	1000.1NPT.210	28	1000.3/8G	29	1000.50.30	38
1000.06.30.03	230	1000.11.30.91	39	1000.1NPT.255	28	1000.3/8NPT	28	1000.50.30.03	230
1000.06.30.91	39	1000.11.85.080	105	1000.20	18	1000.3/8NPT.045	28	1000.50.30.91	39
1000.06.91.025	30	1000.11.85.120	105	1000.20.080	17	1000.3/8NPT.060	28	1000.50.330	17
1000.06.91.030	30	1000.11.91.120	32	1000.20.110	17	1000.3/8NPT.080	28	1000.50.370	17
1000.06.91.035	30	1000.11.92	32	1000.20.150	17	1000.3/8NPT.105	28	1000.50.420	17
1000.06.98.30.03	230	1000.11.98.30.03	230	1000.20.30	38	1000.32	18	1000.50.85.380	104
1000.07.050	23	1000.11/2G	29	1000.20.30.03	230	1000.32.170	17	1000.50.91.420	30
1000.07.065	23	1000.11/2NPT	28	1000.20.30.91	39	1000.32.210	17	1000.50.92	30
1000.07.080	23	1000.11/2NPT.330	28	1000.20.85.120	104	1000.32.255	17	1000.50.98.30.03	230
1000.07.30	38	1000.11/2NPT.370	28	1000.20.85.140	104	1000.32.30	38	1000.63	18
1000.07.30.91	39	1000.11/2NPT.410	28	1000.20.91.150	30	1000.32.30.03	230	1000.63.00.08	231
1000.07.91.050	32	1000.11/4NPT	28	1000.20.92	30	1000.32.30.91	39	1000.63.30	38
1000.07.91.065	32	1000.11/4NPT.240	28	1000.20.98.30.03	230	1000.32.85.220	104	1000.63.30.03	230
1000.07.91.080	32	1000.11/4NPT.285	28	1000.21	24	1000.32.85.250	104	1000.63.30.91	39
1000.08.035	17	1000.11/4NPT.330	28	1000.21.125	23	1000.32.91.255	30	1000.63.400	17
1000.08.050	17	1000.115.30.03	230	1000.21.160	23	1000.32.92	30	1000.63.460	17
1000.08.30	38	1000.115.950	17	1000.21.205	23	1000.32.98.30.03	230	1000.63.520	17
1000.08.30.03	230	1000.12.050	17	1000.21.30	38	1000.36	24	1000.63.85.380	104
1000.08.30.91	39	1000.12.065	17	1000.21.30.91	39	1000.36.260	23	1000.63.85.440	104
1000.08.91.035	30	1000.12.080	17	1000.21.32.30	38	1000.36.30.03	230	1000.63.91.520	30
1000.08.91.050	30	1000.12.30.03	230	1000.21.32.30.91	39	1000.36.30.91	39	1000.63.92	30
1000.08.98.30.03	230	1000.12.30.91	39	1000.21.85.160	105	1000.36.305	23	1000.63.98.30.03	230
1000.085.30.03	230	1000.12.91.050	30	1000.21.85.190	105	1000.36.350	23	1000.75	18
1000.09	24	1000.12.91.065	30	1000.21.91.205	32	1000.36.50.30	38	1000.75.00.08	231
1000.09.00.08	231	1000.12.91.080	30	1000.21.92	32	1000.36.50.30.91	39	1000.75.30.03	230
1000.09.045	23	1000.12.98.30.03	230	1000.21/2G.500	29	1000.36.91.350	32	1000.75.500	17
1000.09.060	23	1000.13	24	1000.21/2G.560	29	1000.36.92	32	1000.75.560	17
1000.09.080	23	1000.13.080	23	1000.25	18	1000.36.98.30.03	230	1000.75.630	17
1000.09.105	23	1000.13.110	23	1000.25.125	17	1000.3G.630	29	1000.85.700	17
1000.09.30	38	1000.13.150	23	1000.25.160	17	1000.3G.700	29	1000.95.750	17
1000.09.30.91	39	1000.13.30	38	1000.25.205	17	1000.40	18	1000.95.800	17
1000.09.91.105	32	1000.13.30.91	39	1000.25.30	38	1000.40.00.08	231	1005.00.08	231
1000.09.92	32	1000.13.91.150	32	1000.25.30.03	230	1000.40.240	17	1006.00.08	231
1000.095.30.03	230	1000.13.92	32	1000.25.30.91	39	1000.40.285	17	1006.00.16	232
1000.1/2G	29	1000.16	24	1000.25.85.160	104	1000.40.30	38	1006.06.08	231
1000.1/2NPT	28	1000.16.080	23	1000.25.85.190	104	1000.40.30.03	230	1007.00.08	231
1000.1/2NPT.080	28	1000.16.110	23	1000.25.91.205	30	1000.40.30.91	39	1007.00.16	232
1000.1/2NPT.110	28	1000.16.150	23	1000.25.92	30	1000.40.330	17	1007.45.16	233
1000.1/2NPT.150	28	1000.16.25.30	38	1000.25.98.30.03	230	1000.40.85.300	104	1007.52	45
1000.1/4NPT.050	28	1000.16.25.30.91	39	1000.29	24	1000.40.91.330	30	1007.80.10	107
1000.1/4NPT.065	28	1000.16.30.91	39	1000.29.190	23	62	30	1008.00.16	232
1000.1/4NPT.080	28	1000.16.85.120	105	1000.29.230	23	1000.40.98.30.03	230	1008.52	45
1000.1/8NPT.040	28	1000.16.85.150	105	1000.29.275	23	1000.42	24	1009.00.16	232
1000.1/8NPT.060	28	1000.16.91.150	32	1000.29.30.03	230	1000.42.00.08	231	1009.45.16	233
1000.10.040	17	1000.16.92	32	1000.29.30.91	39	1000.42.30.91	39	1009.52	45
1000.10.060	17	1000.17	18	1000.29.40.30	38	1000.42.330	23	1010.00.16	232
1000.10.30	38	1000.17.045	17	1000.29.40.30.91	39	1000.42.370	23	1010.52	45
1000.10.30.03	230	1000.17.060	17	1000.29.85.220	105	1000.42.420	23	1011.00.08	231
1000.10.30.91	39	1000.17.080	17	1000.29.85.250	105	1000.42.91.420	32	1011.00.16	232
1000.10.91.040	30	1000.17.105	17	1000.29.91.275	32	1000.42.92	32	1011.00.19	234
1000.10.91.060	30	1000.17.30	38	1000.29.92	32	1000.48	24	1011.45.16	233
1000.10.98.30.03	230	1000.17.30.03	230	1000.29.98.30.03	230	1000.48.00.08	231	1011.52	45
1000.100.30.03	230	1000.17.30.91	39	1000.2G	29	1000.48.30.03	230	1011.80.10	107
1000.100.850	17	1000.17.85.045	104	1000.2NPT	28	1000.48.30.91	39	1012.00.16	232
1000.105.30.03	230	1000.17.85.080	104	1000.2NPT.400	28	1000.48.370	23	1012.00.19	234
1000.105.900	17	1000.17.85.100	104	1000.2NPT.460	28	1000.48.430	23	1012.45.16	233
1000.11	24	1000.17.91.105	30	1000.2NPT.520	28	1000.48.490	23	1012.52	45
1000.11.055	23	1000.17.92	30	1000.3/4G	29	1000.48.91.490	32	1013.00.16	232
1000.11.085	23	1000.17.98.30.03	230	1000.3/4NPT	28	1000.48.92	32	1013.00.22.08	231

1
2
3
4
5
6
7
8
9
10
11

Art.-Nr. Art. No.	Seite Page	Art.-Nr. Art. No.	Seite Page	Art.-Nr. Art. No.	Seite Page	Art.-Nr. Art. No.	Seite Page	Art.-Nr. Art. No.	Seite Page
1013.45.16	233	1040.25.96.70.150	70	1060.12.050	16	1060.36	22	1080.16.110	96
1013.51	45	1040.32.40.160	69	1060.12.065	16	1060.36.305	22	1080.16.140	96
1013.52	45	1040.32.40.205	69	1060.12.075	16	1060.36.350	22	1080.16.52.110	101
1016.00.08	231	1040.32.96.30.160	70	1060.12.52.050	46	1060.40	16	1080.16.52.140	101
1016.00.16	232	1040.32.96.30.205	70	1060.12.52.065	46	1060.40.285	16	1080.16.91.110	99
1016.00.25.08	231	1040.32.96.70.160	70	1060.12.52.075	46	1060.40.330	16	1080.16.91.140	99
1016.45.16	233	1040.32.96.70.205	70	1060.13	22	1060.42	22	1080.17.080	94
1016.51	45	1040.45.16	233	1060.13.080	22	1060.42.370	22	1080.17.100	94
1016.52	45	1040.80.10	107	1060.13.110	22	1060.42.420	22	1080.17.52.080	100
1016.80.10	107	1042.00.16	232	1060.13.145	22	1060.48	22	1080.17.52.100	100
1017.00.16	232	1045.12.050	186	1060.13.52	47	1060.48.430	22	1080.17.91.080	98
1017.00.19	234	1045.12.070	186	1060.13.52.080	47	1060.48.490	22	1080.17.91.100	98
1017.45.16	233	1045.17.060	186	1060.13.52.110	47	1060.50	16	1080.20.110	94
1017.52	45	1045.17.100	186	1060.13.52.145	47	1060.50.370	16	1080.20.140	94
1017.80.10	107	1045.20.080	186	1060.16	22	1060.50.420	16	1080.20.52.110	100
1020.00.19	234	1045.20.130	186	1060.16.080	22	1060.63	16	1080.20.52.140	100
1020.45.16	233	1045.25.110	186	1060.16.110	22	1060.63.460	16	1080.20.91.110	98
1020.51	45	1045.25.170	186	1060.16.145	22	1060.63.520	16	1080.20.91.140	98
1020.52	45	1045.32.150	186	1060.16.52	47	1060.75	16	1080.21.160	96
1020.80.10	107	1045.32.210	186	1060.16.52.080	47	1060.75.560	16	1080.21.190	96
1021.00.16	232	1045.40.230	186	1060.16.52.110	47	1060.75.630	16	1080.21.52.160	101
1021.00.30.08	231	1045.40.280	186	1060.16.52.145	47	1063.00.16	232	1080.21.52.190	101
1021.45.16	233	1045.50.290	186	1060.17	16	1063.00.19	234	1080.21.91.160	99
1021.51	45	1045.50.350	186	1060.17.060	16	1063.45.16	233	1080.21.91.190	99
1021.80.10	107	1045.63.390	186	1060.17.080	16	1063.80.10	107	1080.25.160	94
1025.00.16	232	1045.63.480	186	1060.17.105	16	1080.07.060	96	1080.25.190	94
1025.00.19	234	1048.00.16	232	1060.17.52	46	1080.07.075	96	1080.25.52.160	100
1025.45.16	233	1050.00.16	232	1060.17.52.060	46	1080.07.52.060	101	1080.25.52.190	100
1025.52	45	1050.00.19	234	1060.17.52.080	46	1080.07.52.075	101	1080.25.91.160	98
1025.80.10	107	1050.45.16	233	1060.17.52.105	46	1080.08.035	94	1080.25.91.190	98
1029.00.08	231	1050.80.10	107	1060.20	16	1080.08.040	94	1080.29.230	96
1029.00.16	232	1060.06.025	16	1060.20.080	16	1080.08.52.035	100	1080.29.255	96
1029.00.19	234	1060.06.030	16	1060.20.110	16	1080.08.52.040	100	1080.29.91.230	99
1029.45.16	233	1060.07.050	22	1060.20.145	16	1080.09.080	96	1080.29.91.255	99
1029.80.10	107	1060.07.065	22	1060.20.52	46	1080.09.100	96	1080.32.210	94
1032.00.16	232	1060.07.075	22	1060.20.52.080	46	1080.09.52.080	101	1080.32.250	94
1032.00.19	234	1060.07.52.050	47	1060.20.52.110	46	1080.09.52.100	101	1080.32.52.210	100
1032.45.16	233	1060.07.52.065	47	1060.20.52.145	46	1080.09.91.080	99	1080.32.52.245	100
1032.80.10	107	1060.07.52.075	47	1060.21	22	1080.09.91.100	99	1080.32.91.210	98
1036.00.08	231	1060.08.030	16	1060.21.125	22	1080.10.040	94	1080.32.91.250	98
1036.00.16	232	1060.08.040	16	1060.21.160	22	1080.10.060	94	1080.36.305	96
1036.00.19	234	1060.08.52.030	46	1060.21.190	22	1080.10.52.040	100	1080.36.350	96
1036.45.16	233	1060.08.52.040	46	1060.21.52	47	1080.10.52.060	100	1080.40.285	94
1036.80.10	107	1060.09	22	1060.21.52.125	47	1080.10.91.040	98	1080.40.320	94
1040.00.16	232	1060.09.060	22	1060.21.52.160	47	1080.10.91.060	98	1080.42.370	96
1040.00.19	234	1060.09.080	22	1060.21.52.190	47	1080.11.085	96	1080.42.410	96
1040.17.40.065	69	1060.09.105	22	1060.25	16	1080.11.120	96	1080.48.430	96
1040.17.40.080	69	1060.09.52	47	1060.25.125	16	1080.11.52.080	101	1080.48.465	96
1040.17.96.30.065	70	1060.09.52.060	47	1060.25.160	16	1080.11.52.100	101	1080.50.370	94
1040.17.96.30.080	70	1060.09.52.080	47	1060.25.190	16	1080.11.91.085	99	1080.50.410	94
1040.17.96.70.065	70	1060.09.52.105	47	1060.25.52	46	1080.11.91.120	99	1080.63.460	94
1040.17.96.70.080	70	1060.10.040	16	1060.25.52.125	46	1080.12.060	94	1080.63.500	94
1040.20.40.080	69	1060.10.060	16	1060.25.52.160	46	1080.12.075	94	1080.75.560	94
1040.20.40.105	69	1060.10.52.040	46	1060.25.52.190	46	1080.12.52.060	100	1080.80.650	94
1040.20.96.30.080	70	1060.10.52.060	46	1060.29	22	1080.12.52.075	100	1080.85.700	94
1040.20.96.30.105	70	1060.11	22	1060.29.230	22	1080.12.91.060	98	1080.95.750	94
1040.20.96.70.080	70	1060.11.055	22	1060.29.275	22	1080.12.91.075	98	1081.07.060	93
1040.20.96.70.105	70	1060.11.085	22	1060.32	16	1080.13.110	96	1081.07.075	93
1040.25.40.110	69	1060.11.120	22	1060.32.210	16	1080.13.140	96	1081.09.080	93
1040.25.40.150	69	1060.11.52	47	1060.32.255	16	1080.13.52.110	101	1081.09.100	93
1040.25.96.30.110	70	1060.11.52.060	47	1060.32.52	46	1080.13.52.140	101	1081.11.085	93
1040.25.96.30.150	70	1060.11.52.080	47	1060.32.52.210	46	1080.13.91.110	99	1081.11.120	93
1040.25.96.70.110	70	1060.11.52.105	47	1060.32.52.245	46	1080.13.91.140	99	1081.12.060	92

Art.-Nr. Art. No.	Seite Page	Art.-Nr. Art. No.	Seite Page	Art.-Nr. Art. No.	Seite Page	Art.-Nr. Art. No.	Seite Page	Art.-Nr. Art. No.	Seite Page
1081.12.075	92	1100.08.94.050	60	1100.13.92	33	1100.25.125	20	1100.40.98	64
1081.13.110	93	1100.08.96.035	62	1100.13.94	61	1100.25.160	20	1100.40.98.08	231
1081.13.140	93	1100.08.96.050	62	1100.13.94.150	61	1100.25.205	20	1100.40.98.330	64
1081.16.110	93	1100.08.98.035	64	1100.13.96	63	1100.25.50	43	1100.42	27
1081.16.140	93	1100.08.98.050	64	1100.13.96.150	63	1100.25.51	43	1100.42.330	26
1081.17.080	92	1100.09	27	1100.13.98	65	1100.25.91.205	31	1100.42.370	26
1081.17.100	92	1100.09.045	26	1100.13.98.150	65	1100.25.92	31	1100.42.420	26
1081.20.110	92	1100.09.060	26	1100.16	27	1100.25.94	60	1100.42.91.420	33
1081.20.140	92	1100.09.080	26	1100.16.080	26	1100.25.94.205	60	1100.42.92	33
1081.21.160	93	1100.09.105	26	1100.16.110	26	1100.25.96	62	1100.42.94	61
1081.21.190	93	1100.09.91.105	33	1100.16.150	26	1100.25.96.205	62	1100.42.94.420	61
1081.25.160	92	1100.09.92	33	1100.16.50	43	1100.25.98	64	1100.42.96	63
1081.25.190	92	1100.09.94	61	1100.16.91.150	33	1100.25.98.205	64	1100.42.96.420	63
1081.29.230	93	1100.09.94.105	61	1100.16.92	33	1100.29	27	1100.42.98	65
1081.29.255	93	1100.09.96	63	1100.16.94	61	1100.29.190	26	1100.42.98.08	231
1081.32.210	92	1100.09.96.105	63	1100.16.94.150	61	1100.29.230	26	1100.42.98.420	65
1081.32.250	92	1100.09.98	65	1100.16.96	63	1100.29.275	26	1100.48	27
1083.12.050	91	1100.09.98.08	231	1100.16.96.150	63	1100.29.50	43	1100.48.370	26
1083.12.065	91	1100.09.98.105	65	1100.16.98	65	1100.29.91.275	33	1100.48.430	26
1083.17	91	1100.10.040	20	1100.16.98.150	65	1100.29.92	33	1100.48.490	26
1083.20	91	1100.10.060	20	1100.17	21	1100.29.94	61	1100.48.91.490	33
1083.25	91	1100.10.91.040	31	1100.17.045	20	1100.29.94.275	61	1100.48.92	33
1083.32	91	1100.10.91.060	31	1100.17.060	20	1100.29.96	63	1100.48.94	61
1083.40	91	1100.10.94.040	60	1100.17.080	20	1100.29.96.275	63	1100.48.94.490	61
1083.50	91	1100.10.94.060	60	1100.17.105	20	1100.29.98	65	1100.48.96	63
1083.63	91	1100.10.96.040	62	1100.17.50	43	1100.29.98.275	65	1100.48.96.490	63
1084.17	102	1100.10.96.060	62	1100.17.51	43	1100.32	21	1100.48.98	65
1084.20	102	1100.10.98.040	64	1100.17.91.105	31	1100.32.170	20	1100.48.98.08	231
1084.25	102	1100.10.98.060	64	1100.17.92	31	1100.32.210	20	1100.48.98.490	65
1084.32	102	1100.11	27	1100.17.94	60	1100.32.255	20	1100.50	21
1084.40	102	1100.11.055	26	1100.17.94.105	60	1100.32.50	43	1100.50.330	20
1084.50	102	1100.11.085	26	1100.17.96	62	1100.32.51	43	1100.50.370	20
1084.63	102	1100.11.120	26	1100.17.96.105	62	1100.32.91.255	31	1100.50.420	20
1084.75	102	1100.11.50	43	1100.17.98	64	1100.32.92	31	1100.50.91.420	31
1084.80.650	102	1100.11.91.120	33	1100.17.98.105	64	1100.32.94	60	1100.50.92	31
1084.85.700	102	1100.11.92	33	1100.20	21	1100.32.94.255	60	1100.50.94	60
11...		1100.11.94	61	1100.20.080	20	1100.32.96	62	1100.50.94.420	60
1100.06.025	20	1100.11.94.120	61	1100.20.110	20	1100.32.96.255	62	1100.50.96	62
1100.06.030	20	1100.11.96	63	1100.20.150	20	1100.32.98	64	1100.50.96.420	62
1100.06.035	20	1100.11.96.120	63	1100.20.50	43	1100.32.98.255	64	1100.50.98	64
1100.06.91.025	31	1100.11.98	65	1100.20.51	43	1100.36	27	1100.50.98.08	231
1100.06.91.030	31	1100.11.98.120	65	1100.20.91.150	31	1100.36.260	26	1100.50.98.420	64
1100.06.91.035	31	1100.12.050	20	1100.20.92	31	1100.36.305	26	1100.63	21
1100.07.050	26	1100.12.065	20	1100.20.94	60	1100.36.350	26	1100.63.400	20
1100.07.065	26	1100.12.080	20	1100.20.94.150	60	1100.36.91.350	33	1100.63.460	20
1100.07.080	26	1100.12.91.050	31	1100.20.96	62	1100.36.92	33	1100.63.520	20
1100.07.91.050	33	1100.12.91.065	31	1100.20.96.150	62	1100.36.94	61	1100.63.91.520	31
1100.07.91.065	33	1100.12.91.080	31	1100.20.98	64	1100.36.94.350	61	1100.63.92	31
1100.07.91.080	33	1100.12.94.050	60	1100.20.98.150	64	1100.36.96	63	1100.63.94	60
1100.07.94.050	61	1100.12.94.065	60	1100.21	27	1100.36.96.350	63	1100.63.94.520	60
1100.07.94.065	61	1100.12.94.080	60	1100.21.125	26	1100.36.98	65	1100.63.96	62
1100.07.94.080	61	1100.12.96.050	62	1100.21.160	26	1100.36.98.350	65	1100.63.96.520	62
1100.07.96.050	63	1100.12.96.065	62	1100.21.205	26	1100.40	21	1100.63.98	64
1100.07.96.065	63	1100.12.96.080	62	1100.21.50	43	1100.40.240	20	1100.63.98.08	231
1100.07.96.080	63	1100.12.98.050	64	1100.21.91.205	33	1100.40.285	20	1100.63.98.520	64
1100.07.98.050	65	1100.12.98.065	64	1100.21.92	33	1100.40.330	20	1100.75	21
1100.07.98.065	65	1100.12.98.080	64	1100.21.94	61	1100.40.50	43	1100.75.500	20
1100.07.98.080	65	1100.13	27	1100.21.94.205	61	1100.40.91.330	31	1100.75.560	20
1100.08.035	20	1100.13.080	26	1100.21.96	63	1100.40.92	31	1100.75.630	20
1100.08.050	20	1100.13.110	26	1100.21.96.205	63	1100.40.94	60	1100.75.98.08	231
1100.08.91.035	31	1100.13.150	26	1100.21.98	65	1100.40.94.330	60	1105.98.08	231
1100.08.91.050	31	1100.13.50	43	1100.21.98.205	65	1100.40.96	62	1106.06.98.08	231
1100.08.94.035	60	1100.13.91.150	33	1100.25	21	1100.40.96.330	62	1106.98.08	231

Suchhilfe

Search help

Art.-Nr. Art. No.	Seite Page	Art.-Nr. Art. No.	Seite Page	Art.-Nr. Art. No.	Seite Page	Art.-Nr. Art. No.	Seite Page	Art.-Nr. Art. No.	Seite Page
1107.98.08	231	1160.48.490	25	1165.84.40.34	170	1180.50.370	95	1300.29.300.100	42
1111.98.08	231	1160.50	19	1165.84.50.42	170	1180.50.410	95	1300.29.320.090	42
1113.98.22.08	231	1160.50.420	19	1165.84.63.54	170	1180.63.460	95	1300.29.330.065	42
1116.98.08	231	1160.63	19	1180.07.060	97	1180.63.500	95	1300.32.220.060	40
1116.98.25.08	231	1160.63.520	19	1180.07.075	97	1181.07.060	93	1300.32.220.080	40
1121.98.30.08	231	1160.75	19	1180.08.035	95	1181.07.075	93	1300.40.260.070	40
1129.98.08	231	1160.75.630	19	1180.08.040	95	1181.09.080	93	1300.40.265.090	40
1136.98.08	231	1165.07	164	1180.09.080	97	1181.09.100	93	1300.40.280.060	40
1145.12.050	186	1165.09	164	1180.09.100	97	1181.11.085	93	1300.40.300.100	40
1145.12.070	186	1165.10	163	1180.09.91.080	99	1181.11.120	93	1300.40.320.090	40
1145.17.060	186	1165.11	164	1180.09.91.100	99	1181.12.060	92	1300.40.330.065	40
1145.17.100	186	1165.13	164	1180.10.040	95	1181.12.075	92	1300.42.340.115	42
1145.20.080	186	1165.16	164	1180.10.060	95	1181.13.110	93	1300.42.370.070	42
1145.20.130	186	1165.17	163	1180.10.91.040	98	1181.13.140	93	1300.42.400.060	42
1145.25.110	186	1165.20	163	1180.10.91.060	98	1181.16.110	93	1300.42.400.135	42
1145.25.170	186	1165.21	164	1180.11.085	97	1181.16.140	93	1300.42.420.140	42
1145.32.150	186	1165.25	163	1180.11.120	97	1181.17.080	92	1300.48.460.140	42
1145.32.210	186	1165.29	164	1180.11.91.085	99	1181.17.100	92	1300.48.465.060	42
1145.40.230	186	1165.32	163	1180.11.91.120	99	1181.20.110	92	1300.50.340.115	40
1145.40.280	186	1165.36	164	1180.12.060	95	1181.20.140	92	1300.50.370.070	40
1145.50.290	186	1165.40	163	1180.12.075	95	1181.21.160	93	1300.50.400.060	40
1145.50.350	186	1165.48	164	1180.12.91.060	98	1181.21.190	93	1300.50.400.135	40
1145.63.390	186	1165.50	163	1180.12.91.075	98	1181.25.160	92	1300.50.420.140	40
1145.63.480	186	1165.63	163	1180.13.110	97	1181.25.190	92	1300.63.460.140	40
1145.63.550	186	1165.80.07.060	169	1180.13.140	97	1181.29.230	93	1300.63.465.060	40
1160.06.025	19	1165.80.07.075	169	1180.13.91.110	99	1181.29.255	93	1301.09.090.042	42
1160.06.030	19	1165.80.09.080	169	1180.13.91.140	99	1181.32.210	92	1301.13.130.050	42
1160.07.065	25	1165.80.09.100	169	1180.16.110	97	1181.32.250	92	1301.13.150.050	42
1160.07.075	25	1165.80.10.040	168	1180.16.140	97	1183.12.050	91	1301.16.130.050	42
1160.08.030	19	1165.80.10.060	168	1180.16.91.110	99	1183.12.065	91	1301.16.150.050	42
1160.08.040	19	1165.80.11.085	169	1180.16.91.140	99	1183.17	91	1301.17.090.042	41
1160.09	25	1165.80.11.120	169	1180.17.080	95	1183.20	91	1301.20.130.050	41
1160.09.105	25	1165.80.12.060	168	1180.17.100	95	1183.25	91	1301.20.150.050	41
1160.10.040	19	1165.80.12.075	168	1180.17.91.080	98	1183.32	91	1301.21.190.070	42
1160.10.060	19	1165.80.13.110	169	1180.17.91.100	98	1183.40	91	1301.21.220.060	42
1160.11	25	1165.80.13.140	169	1180.20.110	95	1183.50	91	1301.21.220.080	42
1160.11.120	25	1165.80.16.110	169	1180.20.140	95	1183.63	91	1301.25.190.070	41
1160.12.050	19	1165.80.16.140	169	1180.20.91.110	98	1184.17	103	1301.29.260.070	42
1160.12.065	19	1165.80.17.080	168	1180.20.91.140	98	1184.20	103	1301.29.265.090	42
1160.12.075	19	1165.80.17.100	168	1180.21.160	97	1184.25	103	1301.29.280.060	42
1160.13	25	1165.80.20.110	168	1180.21.190	97	1184.32	103	1301.29.300.100	42
1160.13.145	25	1165.80.20.140	168	1180.21.91.160	99	1184.40	103	1301.29.320.090	42
1160.16	25	1165.80.21.160	169	1180.21.91.190	99	1184.50	103	1301.29.330.065	42
1160.16.145	25	1165.80.21.190	169	1180.25.160	95	1184.63	103	1301.32.220.060	41
1160.17	19	1165.80.25.160	168	1180.25.190	95	1184.75	103	1301.32.220.080	41
1160.17.105	19	1165.80.25.190	168	1180.25.91.160	98	1184.80.650	103	1301.40.260.070	41
1160.20	19	1165.80.29.230	169	1180.25.91.190	98	1184.85.700	103	1301.40.265.090	41
1160.20.145	19	1165.80.29.255	169	1180.29.230	97	13...		1301.40.280.060	41
1160.21	25	1165.80.32.210	168	1180.29.255	97	1300.09.090.042	42	1301.40.300.100	41
1160.21.190	25	1165.80.32.250	168	1180.29.91.230	99	1300.13.130.050	42	1301.40.320.090	41
1160.25	19	1165.80.36.305	169	1180.29.91.255	99	1300.13.150.050	42	1301.40.330.065	41
1160.25.190	19	1165.80.36.350	169	1180.32.210	95	1300.16.130.050	42	1301.42.340.115	42
1160.29	25	1165.80.40.285	168	1180.32.250	95	1300.16.150.050	42	1301.42.370.070	42
1160.29.275	25	1165.80.40.320	168	1180.32.91.210	98	1300.17.090.042	40	1301.42.400.060	42
1160.32	19	1165.80.48.430	169	1180.32.91.250	98	1300.20.130.050	40	1301.42.400.135	42
1160.32.255	19	1165.80.48.465	169	1180.36.305	97	1300.20.150.050	40	1301.42.420.140	42
1160.36	25	1165.80.50.370	168	1180.36.350	97	1300.21.190.070	42	1301.48.460.140	42
1160.36.350	25	1165.80.50.410	168	1180.40.285	95	1300.21.220.060	42	1301.48.465.060	42
1160.40	19	1165.80.63.460	168	1180.40.320	95	1300.21.220.080	42	1301.50.340.115	41
1160.40.330	19	1165.80.63.500	168	1180.42.370	97	1300.25.190.070	40	1301.50.370.070	41
1160.42	25	1165.84.20.15	170	1180.42.410	97	1300.29.260.070	42	1301.50.400.060	41
1160.42.420	25	1165.84.25.21	170	1180.48.430	97	1300.29.265.090	42	1301.50.400.135	41
1160.48	25	1165.84.32.34	170	1180.48.465	97	1300.29.280.060	42	1301.50.420.140	41

Art.-Nr. Art. No.	Seite Page	Art.-Nr. Art. No.	Seite Page	Art.-Nr. Art. No.	Seite Page	Art.-Nr. Art. No.	Seite Page	Art.-Nr. Art. No.	Seite Page
1301.63.460.140	41	1310.25.3.090	34	1311.32.3.105	35	1540.12.080	176	1545.13.07	189
1301.63.465.060	41	1310.25.4.070	34	1311.32.4.090	35	1540.13	180	1545.13.12	189
1310.020.07	234	1310.25.6.060	34	1311.32.6.070	35	1540.13.080	180	1545.16.11	189
1310.030.07	234	1310.29.3.090	36	1370.15	77	1540.13.110	180	1545.16.14	189
1310.040.07	234	1310.32.2.115	34	1370.15.30	77	1540.13.150	180	1545.17.06	187
1310.050.07	234	1310.32.3.090	34	1370.15.49.04	77	1540.16	180	1545.17.1.06	188
1310.060.07	234	1310.32.3.105	34	1370.15.49.45	77	1540.16.080	180	1545.17.1.10	188
1310.070.07	234	1310.32.4.090	34	1370.15.63.12	77	1540.16.110	180	1545.17.10	187
1310.080.07	234	1310.32.6.070	34	14...		1540.16.150	180	1545.20.08	187
1310.09.2.030	36	1311.09.2.030	37	14.582.33	198	1540.17	176	1545.20.1.08	188
1310.09.2.040	36	1311.09.2.040	37	14.582.34	198	1540.17.060	176	1545.20.1.13	188
1310.09.2.050	36	1311.09.2.050	37	14.582.35	198/231	1540.17.080	176	1545.20.13	187
1310.090.07	234	1311.11.2.050	37	14.582.36	198	1540.17.105	176	1545.21.14	189
1310.100.07	234	1311.11.2.060	37	14.582.37	198	1540.20	176	1545.21.18	189
1310.11.2.050	36	1311.11.2.075	37	14.582.38	198	1540.20.080	176	1545.25.1.11	188
1310.11.2.060	36	1311.11.3.050	37	14.582.39	198	1540.20.110	176	1545.25.1.17	188
1310.11.2.075	36	1311.13.2.050	37	14.582.93	198	1540.20.150	176	1545.25.11	187
1310.11.3.050	36	1311.13.2.060	37	14.582.94	198	1540.21	180	1545.25.17	187
1310.110.07	234	1311.13.3.050	37	14.582.95	198	1540.21.125	180	1545.29.25	189
1310.120.07	234	1311.13.3.060	37	14.582.96	198	1540.21.160	180	1545.32.1.25	188
1310.13.2.050	36	1311.13.3.065	37	14.582.97	198	1540.21.205	180	1545.32.25	187
1310.13.2.060	36	1311.13.4.050	37	14.582.98	198	1540.25	176	1545.36.33	189
1310.13.2.075	36	1311.13.4.060	37	14.582.99	198	1540.25.125	176	1545.40.1.33	188
1310.13.3.050	36	1311.16.2.050	37	14.583.03	198	1540.25.160	176	1545.42.38	189
1310.13.3.060	36	1311.16.2.060	37	14.583.04	198	1540.25.205	176	1545.48.44	189
1310.13.3.065	36	1311.16.2.075	37	14.583.05	198	1540.29	180	1545.50.1.38	188
1310.13.4.050	36	1311.16.2.090	37	14.583.06	198	1540.29.190	180	1545.63.1.44	188
1310.13.4.060	36	1311.16.3.050	37	14.583.07	198	1540.29.230	180	1545.N0375.08	190
1310.16.2.050	36	1311.16.3.070	37	14.583.08	198	1540.29.275	180	1545.N0500.07	190
1310.16.2.060	36	1311.16.4.050	37	14.583.09	198	1540.32	176	1545.N0500.12	190
1310.16.2.075	36	1311.16.4.060	37	1400.11	44	1540.32.170	176	1545.N0750.14	190
1310.16.2.090	36	1311.16.4.070	37	1400.16	44	1540.32.210	176	1545.N0750.18	190
1310.16.3.050	36	1311.17.2.040	35	1400.17	44	1540.32.255	176	1545.N1000.22	190
1310.16.3.060	36	1311.17.2.050	35	1400.20	44	1540.36	180	1546.07.06	192
1310.16.3.070	36	1311.20.2.050	35	1400.21	44	1540.36.260	180	1546.09.08	192
1310.16.4.050	36	1311.20.2.060	35	1400.25	44	1540.36.305	180	1546.11.07	192
1310.16.4.060	36	1311.20.2.075	35	15...		1540.36.350	180	1546.11.10	192
1310.16.4.070	36	1311.20.3.050	35	1520.11	181	1540.40	176	1546.12.06	191
1310.17.2.030	34	1311.20.3.060	35	1520.16	181	1540.40.240	176	1546.12.1.06	191
1310.17.2.040	34	1311.20.3.065	35	1520.16.080	181	1540.40.285	176	1546.13.07	192
1310.17.2.050	34	1311.20.4.050	35	1520.16.110	181	1540.40.330	176	1546.13.12	192
1310.20.2.050	34	1311.20.4.060	35	1520.17	177	1540.42	180	1546.16.11	192
1310.20.2.060	34	1311.21.2.070	37	1520.20	177	1540.42.330	180	1546.16.14	192
1310.20.2.075	34	1311.21.2.090	37	1520.20.080	177	1540.42.370	180	1546.17.08	191
1310.20.3.050	34	1311.21.2.100	37	1520.20.110	177	1540.42.420	180	1546.17.1.08	191
1310.20.3.060	34	1311.21.2.115	37	1520.25	177	1540.48	180	1546.20.07	191
1310.20.3.065	34	1311.21.3.070	37	1540.07.050	180	1540.48.370	180	1546.20.1.07	191
1310.20.4.050	34	1311.21.3.090	37	1540.07.065	180	1540.48.430	180	1546.20.1.12	191
1310.20.4.060	34	1311.21.3.105	37	1540.07.080	180	1540.48.490	180	1546.20.12	191
1310.21.2.070	36	1311.21.4.070	37	1540.08.035	176	1540.50	176	1546.N0375.08	193
1310.21.2.090	36	1311.21.4.090	37	1540.08.050	176	1540.50.330	176	1546.N0500.07	193
1310.21.2.100	36	1311.21.6.060	37	1540.09	180	1540.50.370	176	1546.N0500.12	193
1310.21.2.115	36	1311.21.6.070	37	1540.09.060	180	1540.50.420	176	1555.07.06	189
1310.21.3.070	36	1311.25.2.070	35	1540.09.080	180	1540.63	176	1555.09.08	189
1310.21.3.090	36	1311.25.2.090	35	1540.09.105	180	1540.63.400	176	1555.11.07	189
1310.21.4.070	36	1311.25.2.100	35	1540.10.040	176	1540.63.460	176	1555.11.10	189
1310.21.4.090	36	1311.25.3.070	35	1540.10.060	176	1540.63.520	176	1555.12.06	187
1310.21.6.060	36	1311.25.3.090	35	1540.11	180	1545.07.06	189	1555.12.1.06	188
1310.21.6.070	36	1311.25.4.070	35	1540.11.055	180	1545.09.08	189	1555.13.07	189
1310.25.2.070	34	1311.25.6.060	35	1540.11.085	180	1545.11.07	189	1555.13.12	189
1310.25.2.090	34	1311.29.3.090	37	1540.11.120	180	1545.11.10	189	1555.16.11	189
1310.25.2.100	34	1311.32.2.115	35	1540.12.050	176	1545.12.06	187	1555.16.14	189
1310.25.3.070	34	1311.32.3.090	35	1540.12.065	176	1545.12.1.06	188	1555.17.06	187

Art.-Nr. Art. No.	Seite Page	Art.-Nr. Art. No.	Seite Page	Art.-Nr. Art. No.	Seite Page	Art.-Nr. Art. No.	Seite Page	Art.-Nr. Art. No.	Seite Page
1555.17.1.06	188	1571.13.080	178	1571.25.6.060	182	1572.16.110	179	1576.20.1.07	191
1555.17.1.10	188	1571.13.110	178	1571.29	178	1572.16.150	179	1576.20.1.12	191
1555.17.10	187	1571.13.150	178	1571.29.190	178	1572.17	175	1576.20.12	191
1555.20.08	187	1571.13.2.050	183	1571.29.230	178	1572.17.060	175	1576.N0375.08	193
1555.20.1.08	188	1571.13.2.060	183	1571.29.275	178	1572.17.080	175	1576.N0500.07	193
1555.20.1.13	188	1571.13.2.075	183	1571.29.3.090	183	1572.17.105	175	1576.N0500.12	193
1555.20.13	187	1571.13.3.050	183	1571.32	174	1572.20	175	16...	
1555.21.14	189	1571.13.3.060	183	1571.32.170	174	1572.20.080	175	1600.17	199
1555.21.18	189	1571.13.3.065	183	1571.32.2.115	182	1572.20.110	175	1600.20	199
1555.25.1.11	188	1571.13.4.050	183	1571.32.210	174	1572.20.150	175	1600.25	199
1555.25.1.17	188	1571.13.4.060	183	1571.32.255	174	1572.21	179	1600.32	199
1555.25.11	187	1571.16	178	1571.32.3.090	182	1572.21.125	179	1600.40	199
1555.25.17	187	1571.16.080	178	1571.32.3.105	182	1572.21.160	179	1600.50	199
1555.29.25	189	1571.16.110	178	1571.32.4.090	182	1572.21.205	179	1600.63	199
1555.32.1.25	188	1571.16.150	178	1571.32.6.070	182	1572.25	175	1620.17	199
1555.32.25	187	1571.16.2.050	183	1571.36	178	1572.25.125	175	1620.20	199
1555.36.33	189	1571.16.2.060	183	1571.36.260	178	1572.25.160	175	1620.25	199
1555.40.1.33	188	1571.16.2.075	183	1571.36.305	178	1572.25.205	175	1620.32	199
1555.42.38	189	1571.16.3.050	183	1571.36.350	178	1572.29	179	1620.40	199
1555.48.44	189	1571.16.3.060	183	1571.40	174	1572.29.190	179	1620.50	199
1555.50.1.38	188	1571.16.3.065	183	1571.40.240	174	1572.29.230	179	1620.63	199
1555.63.1.44	188	1571.16.4.050	183	1571.40.285	174	1572.29.275	179	17...	
1555.N0375.08	190	1571.16.4.060	183	1571.40.330	174	1572.32	175	1700.07.10	162
1555.N0500.07	190	1571.17	174	1571.42	178	1572.32.170	175	1700.09.14	162
1555.N0500.12	190	1571.17.060	174	1571.42.330	178	1572.32.210	175	1700.11.14	162
1555.N0750.14	190	1571.17.080	174	1571.42.370	178	1572.32.255	175	1700.11.17	162
1555.N0750.18	190	1571.17.105	174	1571.42.420	178	1572.36	179	1700.12.1/4	160
1555.N1000.22	190	1571.17.2.030	182	1571.48	178	1572.36.260	179	1700.12.10	160
1570.09	181	1571.17.2.040	182	1571.48.370	178	1572.36.305	179	1700.13.19	162
1570.11	181	1571.17.2.050	182	1571.48.430	178	1572.36.350	179	1700.16.17	162
1570.13	181	1571.20	174	1571.48.490	178	1572.40	175	1700.16.21	162
1570.16	181	1571.20.080	174	1571.50	174	1572.40.240	175	1700.17.14	160
1570.17	177	1571.20.110	174	1571.50.330	174	1572.40.285	175	1700.20.1/2	160
1570.20	177	1571.20.150	174	1571.50.370	174	1572.40.330	175	1700.20.17	160
1570.21	181	1571.20.2.050	182	1571.50.420	174	1572.42	179	1700.20.19	160
1570.25	177	1571.20.2.060	182	1571.63	174	1572.42.330	179	1700.20.21	160
1570.29	181	1571.20.2.075	182	1571.63.400	174	1572.42.370	179	1700.20.3/8	160
1570.32	177	1571.20.3.050	182	1571.63.460	174	1572.42.420	179	1700.21.27	162
1571.07.050	178	1571.20.3.060	182	1571.63.520	174	1572.48	179	1700.25.21	160
1571.07.065	178	1571.20.3.065	182	1572.07.050	179	1572.48.370	179	1700.25.27	160
1571.07.080	178	1571.20.4.050	182	1572.07.065	179	1572.48.430	179	1700.25.3/4	160
1571.08.035	174	1571.20.4.060	182	1572.07.080	179	1572.48.490	179	1700.29.36	162
1571.08.050	174	1571.21	178	1572.08.035	175	1572.50	175	1700.32.1	160
1571.09	178	1571.21.125	178	1572.08.050	175	1572.50.330	175	1700.32.27	160
1571.09.060	178	1571.21.160	178	1572.09	179	1572.50.370	175	1700.36.45	162
1571.09.080	178	1571.21.2.070	183	1572.09.060	179	1572.50.420	175	1700.40.11/4	160
1571.09.105	178	1571.21.2.090	183	1572.09.080	179	1572.63	175	1700.40.36	160
1571.09.2.030	183	1571.21.2.100	183	1572.09.105	179	1572.63.400	175	1700.42.45	162
1571.09.2.040	183	1571.21.2.205	178	1572.10.040	175	1572.63.460	175	1700.48.56	162
1571.09.2.050	183	1571.21.3.070	183	1572.10.060	175	1572.63.520	175	1700.50.45	160
1571.10.040	174	1571.21.3.090	183	1572.11	179	1576.07.06	192	1700.63.2	160
1571.10.060	174	1571.21.4.070	183	1572.11.055	179	1576.09.08	192	1700.63.56	160
1571.11	178	1571.21.6.060	183	1572.11.085	179	1576.11.07	192	1710.60.07.10	162
1571.11.055	178	1571.25	174	1572.11.120	179	1576.11.10	192	1710.60.09.14	162
1571.11.085	178	1571.25.125	174	1572.12.050	175	1576.12.06	191	1710.60.11.14	162
1571.11.120	178	1571.25.160	174	1572.12.065	175	1576.12.1.06	191	1710.60.11.17	162
1571.11.2.050	183	1571.25.2.070	182	1572.12.080	175	1576.13.07	192	1710.60.12.1/4	161
1571.11.2.060	183	1571.25.2.090	182	1572.13	179	1576.13.12	192	1710.60.12.10	161
1571.11.3.050	183	1571.25.2.100	182	1572.13.080	179	1576.16.11	192	1710.60.13.19	162
1571.12.050	174	1571.25.2.205	174	1572.13.110	179	1576.16.14	192	1710.60.16.17	162
1571.12.065	174	1571.25.3.070	182	1572.13.150	179	1576.17.08	191	1710.60.16.21	162
1571.12.080	174	1571.25.3.090	182	1572.16	179	1576.17.1.08	191	1710.60.17.14	161
1571.13	178	1571.25.4.070	182	1572.16.080	179	1576.20.07	191	1710.60.20.1/2	161

Art.-Nr. Art. No.	Seite Page	Art.-Nr. Art. No.	Seite Page	Art.-Nr. Art. No.	Seite Page	Art.-Nr. Art. No.	Seite Page	Art.-Nr. Art. No.	Seite Page
1710.60.20.17	161	1710.80.50.370.1	165	1800.40.03.330	48	1809.02	53	1852.09.07	83
1710.60.20.19	161	1710.80.50.410.1	165	1800.40.13.330	49	1809.26	120	1852.11.07	83
1710.60.20.21	161	1710.80.63.460.1	165	1800.42.03.410	50	1809.26.50	126	1852.11.09	83
1710.60.20.3/8	161	1710.80.63.460.2	166	1800.42.13.410	51	181/2G.11.26	120	1852.12.05	82
1710.60.21.27	162	1710.80.63.500.1	165	1800.48.03.490	50	181/2G.16.26	120	1852.13.09	83
1710.60.25.21	161	1710.80.63.500.2	166	1800.48.13.490	51	181/2NPT.11.26	121	1852.13.11	83
1710.60.25.27	161	18...		1800.50.03.410	48	181/2NPT.16.26	121	1852.13.13	83
1710.60.25.3/4	161	1800.07.03.065	50	1800.50.13.410	49	1811.02	53	1852.16.07	82
1710.60.29.36	162	1800.07.03.080	50	1800.63.03.520	48	1811.26	120	1852.16.13	83
1710.60.32.1	161	1800.07.13.065	51	1800.63.13.520	49	1811.26.50	126	1852.16.15	83
1710.60.32.27	161	1800.07.13.080	51	1800.75.03.630	48	1811/2G.36.26	120	1852.20.07	82
1710.60.36.45	162	1800.09.03.105	50	1800.75.13.630	49	1811/2NPT.36.26	121	1852.20.09	82
1710.60.40.11/4	161	1800.09.13.105	51	1801.09	81	1811/2NPT.36.27	121	1852.20.11	82
1710.60.40.36	161	1800.10.03.040	48	1801.10.09	57	1811/4G.29.27	120	1852.20.13	82
1710.60.42.45	162	1800.10.03.060	48	1801.10.11	57	1811/4NPT.29.26	121	1852.20.15	82
1710.60.48.56	162	1800.10.09	55	1801.10.13	57	1811/4NPT.29.27	121	1852.21.15	83
1710.60.50.45	161	1800.10.11	55	1801.10.16	57	1812.02	52	1852.21.17	83
1710.60.63.2	161	1800.10.13	55	1801.10.17	56	1813.02	53	1852.21.19	83
1710.60.63.56	161	1800.10.13.040	49	1801.10.20	56	1813.26	120	1852.21.20	83
1710.80.07.060.1	167	1800.10.13.060	49	1801.10.21	57	1816.02	53	1852.25.15	82
1710.80.09.080.1	167	1800.10.16	55	1801.10.25	56	1816.26	120	1852.25.17	82
1710.80.09.100.1	167	1800.10.17	54	1801.10.29	57	1816.26.50	126	1852.25.19	82
1710.80.11.085.1	167	1800.10.20	54	1801.10.32	56	1817.02	52	1852.25.20	82
1710.80.11.120.1	167	1800.10.21	55	1801.10.40	56	1817.09.26	119	1852.29.20	83
1710.80.12.060.1	165	1800.10.25	54	1801.11	81	181G.29.26	120	1852.29.23	83
1710.80.12.060.2	166	1800.10.29	55	1801.11.09	57	181NPT.21.26	121	1852.29.25	83
1710.80.13.110.1	167	1800.10.32	54	1801.11.11	57	181NPT.21.27	121	1852.32.23	82
1710.80.13.140.1	167	1800.10.40	54	1801.11.13	57	1820.02	52	1852.32.25	82
1710.80.16.110.1	167	1800.11.03.120	50	1801.11.16	57	1820.11.26	119	1852.36.26	83
1710.80.16.140.1	167	1800.11.09	55	1801.11.17	56	1820.16.26	119	1852.36.30	83
1710.80.17.080.1	165	1800.11.11	55	1801.11.20	56	1821.02	53	1852.36.33	83
1710.80.17.080.2	166	1800.11.13	55	1801.11.21	57	1821.26	120	1852.36.35	83
1710.80.17.100.1	165	1800.11.13.120	51	1801.11.25	56	1821.26.50	126	1852.40.26	82
1710.80.17.100.2	166	1800.11.16	55	1801.11.29	57	1821.27	120	1852.40.30	82
1710.80.20.110.1	165	1800.11.17	54	1801.11.32	56	1821.27.50	126	1852.40.33	82
1710.80.20.110.2	165	1800.11.20	54	1801.11.40	56	1825.02	52	1852.40.35	82
1710.80.20.110.3	166	1800.11.21	55	1801.13	81	1825.21.26	119	1852.42.35	83
1710.80.20.110.4	166	1800.11.25	54	1801.16	81	1825.21.27	119	1852.42.38	83
1710.80.20.140.1	165	1800.11.29	55	1801.17	81	1829.02	53	1852.42.40	83
1710.80.20.140.2	165	1800.11.32	54	1801.20.10	81	1829.26	120	1852.48.48.40	83
1710.80.20.140.4	166	1800.11.40	54	1801.20.12	81	1829.26.50	126	1852.48.48.44	83
1710.80.21.160.1	167	1800.12.03.065	48	1801.20.14	81	1829.27	120	1863.48.26	119
1710.80.21.190.1	167	1800.12.03.080	48	1801.21	81	183/4G.21.26	120	1863.48.27	119
1710.80.25.160.1	165	1800.12.13.065	49	1801.25	81	183/4G.21.27	120	21...	
1710.80.25.160.2	166	1800.12.13.080	49	1801.29	81	183/4NPT.11.26	121	2111.00.08	231
1710.80.25.190.1	165	1800.13.03.150	50	1801.32	81	183/4NPT.16.26	121	2111.98.08	231
1710.80.25.190.2	166	1800.13.13.150	51	1803.07	80	183/4NPT.21.26	121	24...	
1710.80.29.230.1	167	1800.16.03.150	50	1803.09	80	183/8G.09.26	120	2410.17	206
1710.80.29.255.1	167	1800.16.13.150	51	1803.11	80	183/8NPT.09.26	121	2410.20	206
1710.80.32.210.1	165	1800.17.03.105	48	1803.12	80	1832.02	52	2410.25	206
1710.80.32.210.2	166	1800.17.13.105	49	1803.13	80	1832.29.26	119	2410.32	206
1710.80.32.250.1	165	1800.20.03.150	48	1803.16	80	1836.02	53	2410.40	206
1710.80.32.250.2	166	1800.20.13.150	49	1803.17	80	1836.26	120	2410.50	206
1710.80.36.305.1	167	1800.21.03.205	50	1803.20	80	1836.27	120	2445.12	202
1710.80.36.350.1	167	1800.21.13.205	51	1803.21	80	1840.02	52	2450.07.32	204
1710.80.40.285.1	165	1800.25.03.205	48	1803.25	80	1840.29.27	119	2450.07.34	203
1710.80.40.285.2	166	1800.25.13.205	49	1803.29	80	1848.26	120	2450.11.32	204
1710.80.40.320.1	165	1800.29.03.275	50	1803.32	80	1848.27	120	2450.11.34	203
1710.80.40.320.2	166	1800.29.13.275	51	1803.36	80	1848.48.26	120	2450.12.32	204
1710.80.42.370.1	167	1800.32.03.255	48	1803.40	80	1848.48.27	120	2450.12.34	203
1710.80.42.410.1	167	1800.32.13.255	49	1803.42	80	1850.36.26	119	2450.12.36	205
1710.80.48.430.1	167	1800.36.03.350	50	1803.48.48	80	1850.36.27	119	2450.17.32	204
1710.80.48.465.1	167	1800.36.13.350	51	1807.02	53	1852.07.05	83	2450.17.34	203

Art.-Nr. Art. No.	Seite Page	Art.-Nr. Art. No.	Seite Page	Art.-Nr. Art. No.	Seite Page	Art.-Nr. Art. No.	Seite Page	Art.-Nr. Art. No.	Seite Page
2450.17.36	205	3500.10.06	212	35133/8G	219	3600.13.20	218	3645.16.25	219
2450.20.32	204	3500.10.08	212	3516.09	213	3600.13.25	218	3645.17.20	214
2450.20.34	203	3500.11.06	217	3516.11	213	3600.16.25	218	3645.20.25	214
2450.20.36	205	3500.11.08	217	3516.13	213	3600.16.32	218	3645.21.32	219
2455.12	202	3500.11.10	217	351G.21	219	3600.17.11	216	3645.25.32	214
34...		3500.11.12	217	351NPT.16	220	3600.17.20	214	3645.29.40	219
3409.07	221	3500.11.17	217	3521.11	213	3600.20.13	216	3645.32.40	214
3411.07	221	3500.12.08	212	3521.13	213	3600.20.16	216	3645.40.50	214
3411.09	221	3500.12.10	212	3521.16	213	3600.20.25	214	3645.50.63	214
3413.09	221	3500.13.12	217	3529.13	213	3600.21.32	218	365/8G.16.08	220
3413.11	221	3500.13.17	217	3529.16	213	3600.21.40	218	367/8G.29.08	220
3416.09	221	3500.16.12	217	3529.21	213	3600.25.21	216	37...	
3416.11	221	3500.16.17	217	352G.36	219	3600.25.32	214	3707.09	222
3416.13	221	3500.16.20	217	352G.42	219	3600.29.40	218	3709.11	222
3417.09	223	3500.17.07	216	353/4G.09	219	3600.29.50	218	3711.13	222
3420.11	223	3500.17.10	212	353/4G.11	219	3600.32.29	216	3712.09	223
3421.13	221	3500.17.12	212	353/4G.16	219	3600.32.40	214	3713.16	222
3421.16	221	3500.20.07	216	353/4NPT.11	220	3600.36.50	218	3716.21	222
3425.16	223	3500.20.09	216	353/4NPT.13	220	3600.36.63	218	3720.13	223
3429.21	221	3500.20.11	216	353/8G.07	219	3600.40.36	216	3720.16	223
3436.29	221	3500.20.12	212	3536.21	213	3600.40.50	214	3721.29	222
3440.29	223	3500.20.17	212	3536.29	213	3600.42.63	218	3725.21	223
3450.36	223	3500.21.17	217	3542.29	213	3600.42.75	218	3729.36	222
3455.09.12	224	3500.21.20	217	3542.36	213	3600.48.63	218	3732.29	223
3455.11.17	224	3500.21.25	217	3545.11.17	218	3600.48.75	218	3736.42	222
3455.13.17	224	3500.25.09	216	3545.16.20	218	3600.50.42	216	3742.48	222
3455.13.20	224	3500.25.11	216	3545.17.12	212	3600.50.48	216	3750.42	223
3455.16.20	224	3500.25.13	216	3545.20.12	212	3600.50.63	214	3755.07.12	224
3455.17.12	221	3500.25.16	216	3545.20.17	212	3600.63.75	214	3755.07.17	224
3455.20.12	221	3500.25.17	212	3545.21.20	218	3607.09.08	215	3755.09.17	224
3455.20.17	221	3500.25.20	212	3545.21.25	218	3609.11.08	215	3755.09.20	224
3455.21.25	224	3500.29.25	217	3545.25.17	212	3609.13.08	215	3755.11.20	224
3455.25.12	221	3500.29.32	217	3545.25.20	212	361/2G.11.08	220	3755.12.17	222
3455.25.17	221	3500.32.20	212	3545.29.25	218	361/2G.13.08	220	3755.13.25	224
3455.25.20	221	3500.32.21	216	3545.29.32	218	361/2G.16.08	220	3755.16.25	224
3455.29.32	224	3500.32.25	212	3545.32.20	212	361/2NPT.11	220	3755.17.20	222
3455.32.12	221	3500.36.32	217	3545.32.25	212	361/2NPT.13	220	3755.20.25	222
3455.32.17	221	3500.36.40	217	3545.36.40	218	361/2NPT.16	220	3755.21.32	224
3455.32.20	221	3500.40.25	212	3545.40.25	212	3611.13.08	215	3755.25.32	222
3455.32.25	221	3500.40.29	216	3545.40.32	212	3611.16.08	215	3755.29.40	224
3455.36.40	224	3500.40.32	212	3545.50.32	212	3611.21.08	215	3755.32.40	222
3455.40.17	221	3500.42.32	217	3545.50.40	212	3611/2G.36.08	220	3755.40.50	222
3455.40.20	221	3500.42.40	217	3545.63.40	212	3613.16.08	215	3755.42.50	224
3455.40.25	221	3500.42.50	217	3545.63.50	212	3613.21.08	215	3755.48.63	224
3455.40.32	221	3500.48.40	217	3548.48.36	213	3616.21.08	215	3755.50.63	222
3455.50.20	221	3500.48.50	217	36...		3616.29.08	215	48...	
3455.50.25	221	3500.50.29	216	3600.06.08	214	36161/2G.08	219	4800.24	235
3455.50.32	221	3500.50.32	212	3600.06.10	214	361G.29.08	220	4800.36	235
3455.50.40	221	3500.50.40	212	3600.07.12	218	3621.29.08	215	50...	
3455.63.25	221	3500.63.36	216	3600.07.17	218	36213/4G.08	219	5000.17.50	206
3455.63.32	221	3500.63.40	212	3600.08.10	214	3629.36.08	215	5000.20.50	206
3455.63.40	221	3500.63.50	212	3600.08.12	214	363/4G.21.08	220	5000.25.50	206
3455.63.50	221	3500.75.50	212	3600.09.17	218	363/4NPT.21	220	5000.32.50	206
3463.48	223	3500.75.63	212	3600.09.20	218	363/8G.11.08	220	5030.013.010	171
35...		3509.07	213	3600.10.07	216	3636.42.08	215	5030.013.014	171
3500.07.06	217	351/2G.09	219	3600.10.09	216	3636.48.08	219	5030.013.017	171
3500.07.08	217	351/2NPT.09	220	3600.10.12	214	3636.48.48.08	215	5030.013.021	171
3500.07.10	217	3511.07	213	3600.10.17	214	3642.48.08	219	5030.013.027	171
3500.08.06	212	3511.09	213	3600.11.20	218	3645.07.12	219	5030.013.036	171
3500.09.06	217	3511/4G.29	219	3600.11.25	218	3645.09.17	219	5030.013.045	171
3500.09.08	217	3513.07	213	3600.12.09	216	3645.11.20	219	5030.013.056	171
3500.09.10	217	3513.09	213	3600.12.17	214	3645.12.17	214	5031.034.007	171
3500.09.12	217	3513.11	213	3600.12.20	214	3645.13.20	219	5031.034.009	171

Art.-Nr. Art. No.	Seite Page	Art.-Nr. Art. No.	Seite Page	Art.-Nr. Art. No.	Seite Page	Art.-Nr. Art. No.	Seite Page	Art.-Nr. Art. No.	Seite Page
5031.034.011	171	5215.25.155	196	5636	75	6878.40.32	239	8025.85	106
5031.034.013	171	5215.25.40.155	196	5640	75	6878.40.38	239	8025.96	209
5031.034.016	171	5215.29	74	5650	75	6878.40.50	239	8025.98	209
5031.034.021	171	5215.32	73	57...		80...		8029	207
5031.034.029	171	5215.40	73	5711	75	8000.06	207	8029.85	106
5031.034.036	171	55...		5716	75	8000.06.1	207	8029.96	209
5031.034.048	171	5500.20.17	197	5717	75	8000.08	207	803/4G	207
52...		5500.20.20	197	5720	75	8000.08.1	207	803/8G	207
5200.07	72	5500.20.25	197	5721	75	8000.080	207	8032.85	106
5200.09	72	5500.20.32	197	5725	75	8000.085	207	8032.96	209
5200.11	72	5500.20.40	197	5729	75	8000.095	207	8032.98	209
5200.12	71	5500.20.50	197	5732	75	8000.10	207	8036	207
5200.13	72	5500.40.17	197	68...		8000.10.1	207	8036.85	106
5200.16	72	5500.40.20	197	6850.40.03	238	8000.100	207	8036.96	209
5200.17	71	5500.40.25	197	6850.40.04	238	8000.105	207	8040.85	106
5200.20	71	5500.40.32	197	6850.40.05	238	8000.115	207	8040.96	209
5200.21	72	5500.40.40	197	6850.40.06	238	8000.12	207	8040.98	209
5200.25	71	5500.40.50	197	6850.40.08	238	8000.17	207	8042	207
5200.29	72	5509	76	6850.40.10	238	8000.20	207	8042.85	106
5200.32	71	5513	76	6850.40.12	238	8000.25	207	8048	207
5200.40	71	5516	76	6850.40.14	238	8000.32	207	8048.48	207
5210.07	72	5516.10	76	6850.40.16	238	8000.40	207	8048.85	106
5210.09	72	5516.12	76	6850.40.18	238	8000.50	207	805/8G	207
5210.11	72	5516.13	76	6850.40.20	238	8000.63	207	8050	207
5210.12	71	5517	76	6850.40.22	238	8000.75	207	8050.85	106
5210.13	72	5520	76	6850.40.24	238	8007	207	8050.96	209
5210.16	72	5520.11	197	6850.40.25	238	8007.85	106	8050.98	209
5210.17	71	5520.16	197	6850.40.30	238	8007.96	209	8051	207
5210.20	71	5520.21	197	6850.40.35	238	8008.85	106	8063.85	106
5210.21	72	5520.29	197	6850.40.40	238	8008.96	209	8063.96	209
5210.25	71	5520.36	197	6850.40.45	238	8008.98	209	8063.98	209
5210.29	72	5520.48.48	197	6850.40.50	238	8009	207	82...	
5210.32	71	5521	76	6850.40.70	238	8009.85	106	8207	210
5210.40	71	5521.10	76	6875.40.03	237	8009.96	209	8207.40	210
5215.07	74	5525	76	6875.40.04	237	801/2G	207	8209	210
5215.09	74	5529	76	6875.40.05	237	8010.85	106	8209.40	210
5215.09.65	196	5529.10	76	6875.40.05.10	237	8010.96	209	8211	210
5215.09.95	196	5532	76	6875.40.08	237	8010.98	209	8211.40	210
5215.11	74	5536	76	6875.40.10	237	8011	207	8212	210
5215.11.105	196	5536.10	76	6875.40.10.10	237	8011.85	106	8212.40	210
5215.11.65	196	5540	76	6875.40.15	237	8011.96	209	8213	210
5215.11.95	196	5540.11	197	6875.40.18.06	237	8011/2G	207	8213.40	210
5215.12	73	5540.16	197	6875.40.20	237	8011/4G	207	8216	210
5215.13	74	5540.21	197	6875.40.24	237	8012.85	106	8216.40	210
5215.13.105	196	5540.29	197	6875.40.30.06	237	8012.96	209	8217	210
5215.13.13	196	5540.36	197	6875.40.36	237	8012.98	209	8217.40	210
5215.13.95	196	5540.48.48	197	6875.40.50	237	8013	207	8220	210
5215.16	74	5550	76	6875.70.03	237	8013.85	106	8220.40	210
5215.16.105	196	5563	76	6875.70.04	237	8013.96	209	8221	210
5215.16.13	196	56...		6875.70.05	237	8016	207	8221.40	210
5215.16.155	196	5607	75	6875.70.08	237	8016.85	106	8225	210
5215.16.95	196	5609	75	6875.70.10	237	8016.96	209	8225.40	210
5215.17	73	5611	75	6875.70.15	237	8017.85	106	8229	210
5215.17.40.95	196	5612	75	6875.70.20	237	8017.96	209	8229.40	210
5215.17.95	196	5613	75	6875.70.24	237	8017.98	209	8232	210
5215.20	73	5616	75	6875.70.36	237	801G	207	8232.40	210
5215.20.105	196	5617	75	6875.70.50	237	8020.85	106	8236	210
5215.20.13	196	5620	75	6878.40.06	239	8020.96	209	8236.40	210
5215.20.40.105	196	5621	75	6878.40.09	239	8020.98	209	8240	210
5215.20.40.13	196	5625	75	6878.40.13	239	8021	207	8240.40	210
5215.21	74	5629	75	6878.40.19	239	8021.85	106	8242	210
5215.25	73	5632	75	6878.40.25	239	8021.96	209	8242.40	210

Art.-Nr. Art. No.	Seite Page	Art.-Nr. Art. No.	Seite Page	Art.-Nr. Art. No.	Seite Page	Art.-Nr. Art. No.	Seite Page	Art.-Nr. Art. No.	Seite Page
8245.07	211	8324.17	205	8725.96.11.08	228	8841.20	157	B 212	78
8245.09	211	8324.20	205	8725.96.11.08.70	227	8841.21	157	B 213	79
8245.11	211	87...		8729.08	226	8841.25	157	B 216	79
8245.12	211	8706.08	225	8729.11.08	226	8841.29	157	B 217	78
8245.13	211	8706.11.08	225	8732.08	225	8841.32	157	B 220.10	78
8245.16	211	8707.08	226	8732.11.08	225	8841.36	157	B 220.12	78
8245.17	211	8707.11.08	226	8732.96.08	228	8841.40	157	B 220.14	78
8245.20	211	8708.08	225	8732.96.08.70	227	8841.42	157	B 221	79
8245.21	211	8708.11.08	225	8732.96.11.08	228	8841.48	157	B 225	78
8245.25	211	8709.08	226	8732.96.11.08.70	227	8841.50	157	B 229	79
8245.29	211	8709.11.08	226	8736.08	226	8841.63	157	B 232	78
8245.32	211	8710.07	125	8736.11.08	226	8842	229	B 236	79
8245.36	211	8710.08	225	8740.08	225	8845.12	229	B 240	78
8245.40	211	8710.09	125	8740.11.08	225	8845.17	229	B 242	79
8245.42	211	8710.11	125	8740.96.08	228	8845.20	229	B 248.48	79
8245.48	211	8710.11.08	225	8740.96.08.70	227	8845.25	229	B 250	78
8245.50	211	8710.12	125	8740.96.11.08	228	8845.32	229	B 263	78
8245.63	211	8710.13	125	8740.96.11.08.70	227	8845.40	229	EX10...	
8248.48	210	8710.16	125	8742.08	226	8845.50	229	EX1000.07.065	129
8248.48.40	210	8710.17	125	8745.12	226	8845.63	229	EX1000.07.080	129
8250	210	8710.20	125	8745.17	226	8848.48	229	EX1000.08.035	127
8250.40	210	8710.21	125	8745.20	226	8855.12	229	EX1000.08.050	127
8255.07	211	8710.25	125	8745.25	226	8855.17	229	EX1000.09.060	129
8255.09	211	8710.29	125	8745.32	226	8855.20	229	EX1000.09.080	129
8255.11	211	8710.32	125	8745.40	226	8855.25	229	EX1000.10.040	127
8255.12	211	8710.36	125	8745.50	226	8855.32	229	EX1000.10.060	127
8255.13	211	8710.40	125	8745.63	226	8855.40	229	EX1000.11.055	129
8255.16	211	8710.50	125	8748.08	226	8855.50	229	EX1000.11.085	129
8255.17	211	8710.63	125	8748.48.08	226	8855.63	229	EX1000.12.065	127
8255.20	211	8710.96.08	228	8750.08	225	B 1...		EX1000.12.080	127
8255.21	211	8710.96.08.70	227	8750.11.08	225	B 107	79	EX1000.13.080	129
8255.25	211	8710.96.11.08	228	8750.96.08	228	B 107.00.03	233	EX1000.13.110	129
8255.29	211	8710.96.11.08.70	227	8750.96.08.70	227	B 109	79	EX1000.16.080	129
8255.32	211	8711.08	226	8750.96.11.08	228	B 109.00.03	233	EX1000.16.110	129
8255.36	211	8711.11.08	226	8750.96.11.08.70	227	B 111	79	EX1000.17.060	127
8255.40	211	8712.08	225	8763.08	225	B 111.00.03	233	EX1000.17.080	127
8255.42	211	8712.11.08	225	8763.11.08	225	B 112	78	EX1000.20.080	127
8255.48	211	8712.96.08	228	8763.96.08	228	B 113	79	EX1000.20.110	127
8255.50	211	8712.96.08.70	227	8763.96.08.70	227	B 113.00.03	233	EX1000.21.125	129
8255.63	211	8712.96.11.08	228	8763.96.11.08	228	B 116	79	EX1000.21.160	129
83...		8712.96.11.08.70	227	8763.96.11.08.70	227	B 116.00.03	233	EX1000.25.125	127
8300.07	208	8713.08	226	8775.08	225	B 117	78	EX1000.25.160	127
8300.09	208	8713.11.08	226	8775.11.08	225	B 120.10	78	EX1000.29.190	129
8300.11	208	8716.08	226	8775.96.08	228	B 120.12	78	EX1000.29.230	129
8300.12	208	8716.11.08	226	8775.96.08.70	227	B 120.14	78	EX1000.32.170	127
8300.12.1	208	8717.08	225	8775.96.11.08	228	B 121	79	EX1000.32.210	127
8300.13	208	8717.11.08	225	8775.96.11.08.70	227	B 121.00.03	233	EX1000.36.260	129
8300.16	208	8717.96.08	228	88...		B 125	78	EX1000.36.305	129
8300.17	208	8717.96.08.70	227	8807	229	B 129	79	EX1000.40.240	127
8300.17.1	208	8717.96.11.08	228	8809	229	B 129.00.03	233	EX1000.40.285	127
8300.20	208	8717.96.11.08.70	227	8811	229	B 132	78	EX1080.07.060	139
8300.20.1	208	8720.08	225	8813	229	B 136	79	EX1080.07.075	139
8300.21	208	8720.11.08	225	8816	229	B 136.00.03	233	EX1080.08.035	138
8300.25	208	8720.96.08	228	8821	229	B 140	78	EX1080.08.040	138
8300.25.1	208	8720.96.08.70	227	8829	229	B 142	79	EX1080.09.080	139
8300.29	208	8720.96.11.08	228	8836	229	B 142.00.03	233	EX1080.09.100	139
8300.32	208	8720.96.11.08.70	227	8841.07	157	B 148.00.03	233	EX1080.10.040	138
8300.32.1	208	8721.08	226	8841.09	157	B 148.48	79	EX1080.10.060	138
8300.40	208	8721.11.08	226	8841.11	157	B 150	78	EX1080.11.085	139
8300.40.1	208	8725.08	225	8841.12	157	B 163	78	EX1080.11.120	139
8300.50.1	208	8725.11.08	225	8841.13	157	B 2...		EX1080.12.060	138
8300.63.1	208	8725.96.08	228	8841.16	157	B 209	79	EX1080.12.075	138
8324.12	205	8725.96.08.70	227	8841.17	157	B 211	79	EX1080.13.110	139

Art.-Nr. Art. No.	Seite Page	Art.-Nr. Art. No.	Seite Page	Art.-Nr. Art. No.	Seite Page	Art.-Nr. Art. No.	Seite Page	Art.-Nr. Art. No.	Seite Page
EX1080.13.140	139	EX1100.25.160	128	EX1310.32.4.090	131	EX1530.63.520	149	EX1540.42.350	146
EX1080.16.110	139	EX1100.29.190	130	EX1310.32.6.070	131	EX1540.09.060	146	EX1540.42.370	146
EX1080.16.140	139	EX1100.29.230	130	EX1310.36.2.150	132	EX1540.09.080	146	EX1540.42.390	146
EX1080.17.080	138	EX1100.32.170	128	EX1310.36.4.100	132	EX1540.09.2.030	148	EX1540.42.4.100	148
EX1080.17.100	138	EX1100.32.210	128	EX1310.40.2.150	131	EX1540.09.4.015	148	EX1540.42.420	146
EX1080.20.110	138	EX1100.36.260	130	EX1310.40.7.090	131	EX1540.11.055	146	EX1540.48.3.180	148
EX1080.20.140	138	EX1100.36.305	130	EX1310.48.3.180	132	EX1540.11.085	146	EX1540.48.430	146
EX1080.21.160	139	EX1100.40.240	128	EX1310.48.6.120	132	EX1540.11.2.050	148	EX1540.48.450	146
EX1080.21.190	139	EX1100.40.285	128	EX1310.50.4.100	131	EX1540.11.3.030	148	EX1540.48.470	146
EX1080.25.160	138	EX1126.1/2NPT.110	124	EX1310.63.3.180	131	EX1540.13.080	146	EX1540.48.490	146
EX1080.25.190	138	EX1126.1/2NPT.140	124	EX1310.63.6.120	131	EX1540.13.110	146	EX1540.48.6.120	148
EX1080.29.230	139	EX1126.11/2NPT.360	124	EX15...		EX1540.13.2.050	148	EX1540.50.350	144
EX1080.29.255	139	EX1126.11/4NPT.320	124	EX1530.09.060	150	EX1540.13.3.040	148	EX1540.50.370	144
EX1080.32.210	138	EX1126.17.070	122	EX1530.09.080	150	EX1540.16.080	146	EX1540.50.390	144
EX1080.36.305	139	EX1126.17.100	122	EX1530.11.055	150	EX1540.16.110	146	EX1540.50.4.100	147
EX1080.40.285	138	EX1126.1NPT.230	124	EX1530.11.085	150	EX1540.16.3.060	148	EX1540.50.420	144
EX1081.07.060	137	EX1126.1NPT.260	124	EX1530.13.080	150	EX1540.16.6.030	148	EX1540.63.3.180	147
EX1081.07.075	137	EX1126.20.110	122	EX1530.13.110	150	EX1540.17.060	144	EX1540.63.440	144
EX1081.09.080	137	EX1126.20.140	122	EX1530.16.080	150	EX1540.17.080	144	EX1540.63.460	144
EX1081.09.100	137	EX1126.25.150	122	EX1530.16.110	150	EX1540.17.2.030	147	EX1540.63.480	144
EX1081.11.085	137	EX1126.25.180	122	EX1530.17.060	149	EX1540.17.4.015	147	EX1540.63.520	144
EX1081.11.120	137	EX1126.2NPT.440	124	EX1530.17.080	149	EX1540.20.080	144	EX1540.63.6.120	147
EX1081.12.060	137	EX1126.3/4NPT.150	124	EX1530.20.080	149	EX1540.20.110	144	EX1571.09.060	145
EX1081.12.075	137	EX1126.3/4NPT.180	124	EX1530.20.110	149	EX1540.20.2.050	147	EX1571.09.080	145
EX1081.13.110	137	EX1126.3/8NPT.070	124	EX1530.21.125	150	EX1540.20.6.030	147	EX1571.09.2.030	148
EX1081.13.140	137	EX1126.3/8NPT.100	124	EX1530.21.160	150	EX1540.21.125	146	EX1571.09.4.015	148
EX1081.16.110	137	EX1126.32.230	122	EX1530.21.190	150	EX1540.21.160	146	EX1571.11.055	145
EX1081.16.140	137	EX1126.32.260	122	EX1530.21.205	150	EX1540.21.190	146	EX1571.11.085	145
EX1081.17.080	137	EX1126.40.260	122	EX1530.25.125	149	EX1540.21.205	146	EX1571.11.2.050	148
EX1081.17.100	137	EX1126.40.320	122	EX1530.25.160	149	EX1540.21.3.090	148	EX1571.11.3.030	148
EX1081.20.110	137	EX1126.50.360	122	EX1530.25.190	149	EX1540.21.4.070	148	EX1571.13.080	145
EX1081.20.140	137	EX1126.50.420	122	EX1530.25.205	149	EX1540.25.125	144	EX1571.13.110	145
EX1081.21.160	137	EX1126.63.440	122	EX1530.29.210	150	EX1540.25.160	144	EX1571.13.2.050	148
EX1081.21.190	137	EX1126.63.500	122	EX1530.29.230	150	EX1540.25.190	144	EX1571.13.3.040	148
EX1081.25.160	137	EX13...		EX1530.29.250	150	EX1540.25.2.100	147	EX1571.16.080	145
EX1081.25.190	137	EX1310.09.2.030	132	EX1530.29.275	150	EX1540.25.205	144	EX1571.16.110	145
EX1081.29.230	137	EX1310.09.4.015	132	EX1530.32.210	149	EX1540.25.3.090	147	EX1571.16.3.060	148
EX1081.29.255	137	EX1310.11.2.040	132	EX1530.32.220	107/149	EX1540.25.4.070	147	EX1571.16.6.030	148
EX1081.32.210	137	EX1310.11.2.050	132	EX1530.32.230	149	EX1540.25.6.060	147	EX1571.17.060	143
EX11...		EX1310.11.3.030	132	EX1530.32.255	149	EX1540.29.210	146	EX1571.17.080	143
EX1100.07.065	130	EX1310.12.3.010	131	EX1530.36.285	150	EX1540.29.230	146	EX1571.17.2.030	147
EX1100.07.080	130	EX1310.13.2.050	132	EX1530.36.305	150	EX1540.29.250	146	EX1571.17.4.015	147
EX1100.08.035	128	EX1310.13.3.040	132	EX1530.36.325	150	EX1540.29.275	146	EX1571.20.080	143
EX1100.08.050	128	EX1310.16.2.060	132	EX1530.36.350	150	EX1540.29.3.090	148	EX1571.20.110	143
EX1100.09.060	130	EX1310.16.3.060	132	EX1530.40.270	149	EX1540.29.6.065	148	EX1571.20.2.050	147
EX1100.09.080	130	EX1310.16.6.030	132	EX1530.40.285	149	EX1540.32.210	144	EX1571.20.6.030	147
EX1100.10.040	128	EX1310.16.6.040	132	EX1530.40.300	149	EX1540.32.220	144	EX1571.21.125	145
EX1100.10.060	128	EX1310.17.2.030	131	EX1530.40.330	149	EX1540.32.230	144	EX1571.21.160	145
EX1100.11.055	130	EX1310.17.4.015	131	EX1530.42.350	150	EX1540.32.255	144	EX1571.21.190	145
EX1100.11.085	130	EX1310.20.2.050	131	EX1530.42.370	150	EX1540.32.4.090	147	EX1571.21.205	145
EX1100.12.065	128	EX1310.20.2.075	131	EX1530.42.390	150	EX1540.32.6.070	147	EX1571.21.3.090	148
EX1100.12.080	128	EX1310.20.3.060	131	EX1530.42.420	150	EX1540.36.2.150	148	EX1571.21.4.070	148
EX1100.13.080	130	EX1310.20.4.050	131	EX1530.48.430	150	EX1540.36.285	146	EX1571.25.125	143
EX1100.13.110	130	EX1310.20.6.030	131	EX1530.48.450	150	EX1540.36.305	146	EX1571.25.160	143
EX1100.16.080	130	EX1310.21.3.090	132	EX1530.48.470	150	EX1540.36.325	146	EX1571.25.190	143
EX1100.16.110	130	EX1310.21.4.070	132	EX1530.48.490	150	EX1540.36.350	146	EX1571.25.2.100	147
EX1100.17.060	128	EX1310.25.2.100	131	EX1530.50.350	149	EX1540.36.4.100	148	EX1571.25.205	143
EX1100.17.080	128	EX1310.25.3.070	131	EX1530.50.370	149	EX1540.40.2.150	147	EX1571.25.3.090	147
EX1100.20.080	128	EX1310.25.3.090	131	EX1530.50.390	149	EX1540.40.270	144	EX1571.25.4.070	147
EX1100.20.110	128	EX1310.25.4.070	131	EX1530.50.420	149	EX1540.40.285	144	EX1571.25.6.060	147
EX1100.21.125	130	EX1310.25.6.060	131	EX1530.63.440	149	EX1540.40.300	144	EX1571.29.210	145
EX1100.21.160	130	EX1310.29.3.090	132	EX1530.63.460	149	EX1540.40.330	144	EX1571.29.230	145
EX1100.25.125	128	EX1310.29.6.065	132	EX1530.63.480	149	EX1540.40.7.090	147	EX1571.29.250	145

Art.-Nr. Art. No.	Seite Page	Art.-Nr. Art. No.	Seite Page	Art.-Nr. Art. No.	Seite Page	Art.-Nr. Art. No.	Seite Page	Art.-Nr. Art. No.	Seite Page
EX1571.29.275	145	EX1700.50.45.370	142	EX1803.80.42.410	141	EX3500.29.25	153	EX8750.08	156
EX1571.29.3.090	148	EX1700.63.56.460	142	EX1803.80.48.430	141	EX3500.29.32	153	EX8763.08	156
EX1571.29.6.065	148	EX18...		EX1803.80.48.465	141	EX3500.32.20	152	W11...	
EX1571.32.210	143	EX1801.09	136	EX1803.80.50.370	140	EX3500.32.25	152	W1100.12.95.050	66
EX1571.32.220	143	EX1801.11	136	EX1803.80.50.410	140	EX3500.36.32	153	W1100.12.95.065	66
EX1571.32.230	143	EX1801.13	136	EX1803.80.63.460	140	EX3500.36.40	153	W1100.12.95.080	66
EX1571.32.255	143	EX1801.16	136	EX1803.80.63.500	140	EX3500.40.25	152	W1100.17.95.105	66
EX1571.32.4.090	147	EX1801.17	135	EX1811.09	136	EX3500.40.32	152	W1100.20.95.150	66
EX1571.32.6.070	147	EX1801.20	135	EX1811.11	136	EX3500.42.32	153	W1100.25.95.205	66
EX1571.36.2.150	148	EX1801.21	136	EX1811.13	136	EX3500.42.40	153	W1100.32.95.255	66
EX1571.36.285	145	EX1801.25	135	EX1811.16	136	EX3500.42.50	153	W1100.40.95.330	66
EX1571.36.305	145	EX1801.29	136	EX1811.17	135	EX3500.48.40	153		
EX1571.36.325	145	EX1801.32	135	EX1811.20	135	EX3500.48.50	153		
EX1571.36.350	145	EX1801.40	135	EX1811.21	136	EX3500.50.32	152		
EX1571.36.4.100	148	EX1803.07.03.065	134	EX1811.25	135	EX3500.50.40	152		
EX1571.40.2.150	147	EX1803.07.03.080	134	EX1811.29	136	EX3500.63.40	152		
EX1571.40.270	143	EX1803.09	134	EX1811.32	135	EX3500.63.50	152		
EX1571.40.285	143	EX1803.11	134	EX1811.40	135	EX36...			
EX1571.40.300	143	EX1803.12.03.065	133	EX1826.17.070	123	EX3600.07.12	155		
EX1571.40.330	143	EX1803.12.03.080	133	EX1826.17.100	123	EX3600.07.17	155		
EX1571.40.7.090	147	EX1803.13	134	EX1826.20.110	123	EX3600.08.10	154		
EX1571.42.350	145	EX1803.16	134	EX1826.20.140	123	EX3600.09.17	155		
EX1571.42.370	145	EX1803.17	133	EX1826.25.150	123	EX3600.09.20	155		
EX1571.42.390	145	EX1803.20	133	EX1826.25.180	123	EX3600.10.12	154		
EX1571.42.4.100	148	EX1803.21	134	EX1826.32.230	123	EX3600.11.20	155		
EX1571.42.420	145	EX1803.25	133	EX1826.32.260	123	EX3600.11.25	155		
EX1571.48.3.180	148	EX1803.29	134	EX1826.40.260	123	EX3600.12.17	154		
EX1571.48.430	145	EX1803.32	133	EX1826.40.320	123	EX3600.13.20	155		
EX1571.48.450	145	EX1803.36	134	EX1826.50.360	123	EX3600.13.25	155		
EX1571.48.470	145	EX1803.40	133	EX1826.50.420	123	EX3600.16.25	155		
EX1571.48.490	145	EX1803.42	134	EX1826.63.440	123	EX3600.16.32	155		
EX1571.48.6.120	148	EX1803.48	134	EX1826.63.500	123	EX3600.17.20	154		
EX1571.50.350	143	EX1803.50	133	EX24...		EX3600.20.25	154		
EX1571.50.370	143	EX1803.63	133	EX2450.12.34	151/203	EX3600.21.32	155		
EX1571.50.390	143	EX1803.80.07.060	141	EX2450.17.34	151/203	EX3600.21.40	155		
EX1571.50.4.100	147	EX1803.80.07.075	141	EX2450.20.34	151/203	EX3600.25.32	154		
EX1571.50.420	143	EX1803.80.09.080	141	EX35...		EX3600.29.40	155		
EX1571.63.3.180	147	EX1803.80.09.100	141	EX3500.07.08	153	EX3600.29.50	155		
EX1571.63.440	143	EX1803.80.11.085	141	EX3500.07.10	153	EX3600.32.40	154		
EX1571.63.460	143	EX1803.80.11.120	141	EX3500.09.08	153	EX3600.36.50	155		
EX1571.63.480	143	EX1803.80.12.060	140	EX3500.09.10	153	EX3600.36.63	155		
EX1571.63.520	143	EX1803.80.12.075	140	EX3500.09.12	153	EX3600.40.50	154		
EX1571.63.6.120	147	EX1803.80.13.110	141	EX3500.10.08	152	EX3600.42.63	155		
EX17...		EX1803.80.13.140	141	EX3500.11.08	153	EX3600.48.63	155		
EX1700.12.10.065	142	EX1803.80.16.110	141	EX3500.11.10	153	EX3600.50.63	154		
EX1700.17.14.060	142	EX1803.80.16.140	141	EX3500.11.12	153	EX87...			
EX1700.17.14.080	142	EX1803.80.17.080	140	EX3500.11.17	153	EX8707.08	156		
EX1700.17.14.105	142	EX1803.80.17.100	140	EX3500.12.08	152	EX8708.08	156		
EX1700.20.17.080	142	EX1803.80.20.110	140	EX3500.12.10	152	EX8709.08	156		
EX1700.20.17.110	142	EX1803.80.20.140	140	EX3500.13.12	153	EX8710.08	156		
EX1700.20.19.080	142	EX1803.80.21.160	141	EX3500.13.17	153	EX8711.08	156		
EX1700.20.19.110	142	EX1803.80.21.190	141	EX3500.16.12	153	EX8712.08	156		
EX1700.20.19.150	142	EX1803.80.25.160	140	EX3500.16.17	153	EX8713.08	156		
EX1700.20.21.080	142	EX1803.80.25.190	140	EX3500.16.20	153	EX8716.08	156		
EX1700.20.21.110	142	EX1803.80.29.230	141	EX3500.17.10	152	EX8717.08	156		
EX1700.20.21.150	142	EX1803.80.29.255	141	EX3500.17.12	152	EX8720.08	156		
EX1700.25.21.125	142	EX1803.80.32.210	140	EX3500.20.12	152	EX8721.08	156		
EX1700.25.21.160	142	EX1803.80.32.250	140	EX3500.20.17	152	EX8725.08	156		
EX1700.25.27.125	142	EX1803.80.36.305	141	EX3500.21.17	153	EX8729.08	156		
EX1700.25.27.160	142	EX1803.80.36.350	141	EX3500.21.20	153	EX8732.08	156		
EX1700.25.27.205	142	EX1803.80.40.285	140	EX3500.21.25	153	EX8736.08	156		
EX1700.32.27.210	142	EX1803.80.40.320	140	EX3500.25.17	152	EX8740.08	156		
EX1700.40.36.285	142	EX1803.80.42.370	141	EX3500.25.20	152	EX8748.08	156		

Anfrage für eine Speziallösung Enquiry for a special solution

Kunden Nr.: Customer No.:	Ansprechpartner: Contact:
Jahresbedarf Menge / Stk.: Annual required volume / pieces	Rahmen / Laufzeit: Scope / timeframe:
Preisvorstellung: Pricing expectations:		

Abmessungen Kabelverschraubung Cable gland dimensions

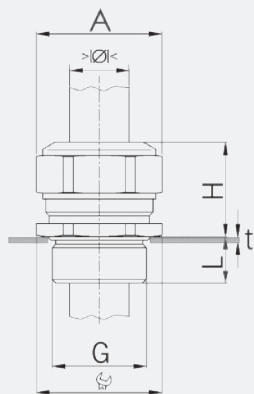

Basis Standard
Standard basis

Für Innenmontage
or interior assembly

- $\varnothing A$ Aussendurchmesser
Outer diameter mm
- G** Anschlussgewinde
Entry thread mm
- H** Zielhöhe des Bauteils
Target height of component mm
- L** max. Auftrag in Gerät
Max. protrusion in equipment mm
- t** Blechdicke
Sheet metal thickness mm
- Schlüsselweite
Spanner jaw gap mm
- $\nabla \varnothing k$ Kabelklemmbereich
Cable clamping range mm

Materialanforderungen Gehäuse Material requirements: enclosure

- | | |
|--|--|
| <input type="checkbox"/> Messing vernickelt (Standard)
Nickel-plated brass (standard) | <input type="checkbox"/> Rostfreier Stahl A2
Stainless steel A2 |
| <input type="checkbox"/> Säurebeständiger Stahl A4
Acid-resistant stainless steel A4 | <input type="checkbox"/> Andere
Others |

Materialanforderungen Dichteinsatz Material requirements: sealing insert

- | | |
|---|---|
| <input type="checkbox"/> TPE | <input type="checkbox"/> NBR |
| <input type="checkbox"/> FPM | <input type="checkbox"/> Multi-Dichteinsatz
Multi sealing insert |
| <input type="checkbox"/> Mit Schlauchanbindung
With conduit connection | <input type="checkbox"/> Andere
Others |

Besondere Bedingungen Special conditions

- Einsatzgebiet: z.B. Lebensmittel, Pharma, Bahn etc.
Where used: e.g. foodstuffs, pharmaceuticals, railway
- IP-Schutzgrad / Druck / Zeit
P protection class rating / pressure / time / /
- Temperaturbereich
Temperature range - °C + °C
- Medienbeständigkeit / gasförmig / flüssig
Resistance to chemical substances / gaseous / fluid /
- Strahlungsbeständigkeit
Radiation resistance
- Ex-Anforderungen (Einsatz Ex i, Ex e II, Ex d II C)
Hazardous area requirements (Ex i, Ex e II, Ex d II C)
- EMV
EMC
- Normative Anforderungen
Requirements from standards

Systeme und Lösungen für die professionelle Elektro-Installation.

Systems and solutions for the professional electrical installation.



Elektro-Installation
Electrical installation



Kabelverschraubungen
Cable glands



Kabelschutzschläuche
Protective cable conduits



Explosionsschutz
Explosion protection



Brandschutz
Fire protection



Schallschutz
Sound insulation



EMV
EMC



Android APP deutsch



Android APP english



iOS APP deutsch



iOS APP english

Alle weiterführenden Informationen zu Produkten, Lösungen und Kommunikationsmedien finden Sie auf: www.agro.ch.

Please find additional information about products, system solutions and communication media on: www.agro.ch.