

# AGRO Kabelschutzschläuche

## AGRO Protective cable conduits

Professionelle Schutzschlauch Systeme.  
Professional protective conduit systems.

18



Schläuche aus Kunststoff und Metall . Verschraubungen . Geflechte . Zubehör  
Synthetic and metal conduits . connectors . braided sleeveings . accessories

 **AGRO**  
... your quality-connection



## Professionelle Lösungen von AGRO für die sichere Kabelführung

**Kabelschutzschläuche und Verschraubungen aus Kunststoff** sind im Maschinen- und Anlagenbau, in der Automation, Energietechnik, im Fahrzeug- sowie im Schienenfahrzeugbau zu finden. Sie schützen Kabel und Datenleitungen vor äusseren Einflüssen, Bruch oder Beschädigungen.

**Kabelschutzschläuche und Verschraubungen aus Metall** sind im Maschinen- und Anlagenbau, in der Automation, Energietechnik, im Fahrzeug- sowie im Schienenfahrzeugbau zu finden. Sie schützen Kabel und Leitungen vor Bruch oder Beschädigungen und schirmen Datenleitungen vor elektromagnetischen Einflüssen ab.

**AGROflex Geflechschläuche** werden als Kabelschutz, zur Kabelbündelung oder als Isolierschlauch verwendet. Ideal für den Einsatz in Elektromotoren, Transformatoren, Schaltschränken, Strom- und Messwandlern, im Automobil- und Schienenfahrzeugbau sowie in der Elektrogeräteindustrie.

**AGRO Kombi-Schlauchverschraubungen aus Metall** sind eine optimale Kombination, wenn Kabel in einem Schutzschlauch in ein Gehäuse eingeführt werden und gleichzeitig eine sichere Abdichtung und Zugentlastung des Kabels erforderlich ist.

## Professional solutions made by AGRO for safe cable routing

**Cable conduits and cable glands made of synthetic materials** can be found in the construction of machines and systems, in automation and power engineering applications, as well as in the design of road and railway vehicles. They protect cables and data lines from external influences, breakage or damage.

**Cable conduits and cable glands made of metal** can be found in the construction of machines and systems, in automation and power engineering applications as well as in the design of road and railway vehicles. They protect cables and lines from breakage or damage and also shield data lines from electromagnetic influences.

**AGROflex braided sleeveings** are used to protect cables, bundle them together or serve as insulated tubing. They are ideal for use in electric motors, transformers, electrical cabinets, power converters and transducers, in the design of road and railway vehicles and in the electrical equipment industry.

**AGRO combination conduit glands made of metal** provide an optimal combination if you want to feed cables running through a conduit into an enclosure and at the same time want a secure seal and strain relief for the cables.





**Schutzschläuche aus Kunststoff**  
Synthetic protective conduits



15 - 31

1



**Kunststoff Schlauchverschraubungen**  
Synthetic conduit connectors



32 - 66

2



**Schlauchhalter zu Kunststoff Schutzschlauch**  
Conduit clamps for synthetic protective conduit



67 - 75

3



**Schutzschläuche aus Metall und Kunststoff**  
nicht flüssigkeitsdicht und flüssigkeitsdicht  
**Protective metal and synthetic conduits**  
not liquid tight and liquid tight



76 - 86

4



**EMV Metallschutzschläuche**  
EMC metal protective conduits



87 - 92

5

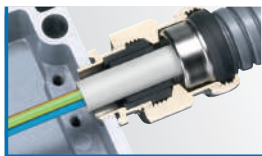

**Ex Kombi-Schlauchverschraubung und Schutzschläuche aus Metall**  
Combination conduit gland and protective conduits for Ex applications



93 - 102

6



**Metall Schlauchverschraubungen**  
Metal conduit glands



103 - 128

7



**Liquid Tight Metallschutzschläuche und Verschraubungen**  
Liquid tight metal protective conduits and conduit glands



129 - 137

8



**Optoflex Metallschutzschläuche**  
Optoflex protective conduits



138 - 140

9



**AGRO Geflechschläuche**  
AGRO Braided sleeves

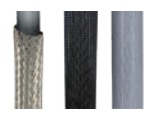

141 - 145

10



**Zubehör**  
Accessories



146 - 180

11



**Zusatzinformationen**  
Additional information



181 - 203

12



**AGRO**  
Hunzenschwil, Schweiz  
Hunzenschwil, Switzerland

**Seit 1953, also seit mehr als 60 Jahren,** entwickelt und fertigt AGRO vom Standort Hunzenschwil (Schweiz) aus qualitativ hochwertige Produkte und Systeme zur Einführung und Verlegung von Kabeln für die Maschinenindustrie, für den Anlagen- und Apparatebau sowie für die professionelle Elektroinstallation in Gebäuden aller Art. AGRO gehört seit 2002 zur KAISER-Unternehmensfamilie. Die Synergien, die wir aus den Unternehmen ziehen, kommen Ihnen national und international zu Gute.

**Since 1953, for more than 60 years,** AGRO has been developing and manufacturing high-quality products and systems for the installation and entry of cables in the machine industry, as well as for plant engineering and construction, equipment manufacturing and professional electrical installation in buildings of all kinds. Headquartered in Hunzenschwil, Switzerland, AGRO has been part of the KAISER group since 2002. Our customers benefit from the resulting synergies both in the domestic market and abroad.

## **Gemeinsam Zukunft gestalten.** Creating **the future together.**

Die Marken KAISER, AGRO, HELIA und ATTEMA bieten Ihnen immer die marktgerechte Installationslösung und unterstützen Sie so effektiv bei Ihren täglichen Aufgaben. Durch die kontinuierliche, zukunftsorientierte Produktinnovation sind Sie mit den vier starken Marken stets auf dem neuesten Stand der Technik – heute und morgen.

The KAISER, AGRO, HELIA and ATTEMA brands consistently offer you installation solutions which meet the needs of the market and thereby effectively support you in your daily work. Through their continuous future-oriented product innovations, these four strong brands provide assurance that you are always at the state of the art – today and tomorrow.

**KAISER Hauptsitz / headquarters**  
Schalksmühle, Deutschland  
Schalksmühle, Germany



**ATTEMA**  
Gorinchem, Niederlande  
Gorinchem, Netherlands



**HELIA**  
Bornem, Belgien  
Bornem, Belgium







 **KAISER**  
GROUP



Die KAISER Gruppe, ein Familienunternehmen in der dritten Generation, setzt seit jeher auf Fortschritt und Tradition. Als Innovationsführer im Bereich von Elektroinstallationsprodukten und Kabeleinführungen wollen wir für unsere Kunden mit starken Ideen und Lösungen der Branche stets einen Schritt voraus sein. Qualifizierte, erfahrene Mitarbeiterinnen und Mitarbeiter sind dabei der Garant für die hohe Qualität von KAISER. Unsere Partner im Fachhandwerk und -handel sowie in der Industrie können auf unsere Innovationskraft für die Märkte von heute und morgen vertrauen. Dies gilt auch für den kundennahen Service und die schnelle Lieferfähigkeit, die eine starke Elektromarke auszeichnen.

The KAISER Group, a family-run company in its third generation, has always placed emphasis on progress and tradition. As a leading innovator in the area of electrical installation products and cable entries, our goal is to continuously be a step ahead for the benefit of our customers through powerful ideas and solutions in this sector. In this regard, our qualified, experienced employees are the guarantee of the high quality you can expect from KAISER. Our partners in the trades and professional retailers as well as throughout industry can place their trust in our innovative power, which allows us to address the markets of today and tomorrow. The same is also true for our customer-oriented service and fast delivery times, aspects which mark a truly strong brand of electrical products.

Ulrich Kaiser  
KAISER GmbH & Co. KG

Burkard Kaiser  
Geschäftsführer / CEO  
KAISER GmbH & Co. KG

# Zuordnung Kunststoff Schutzschläuche und Anschlusssteile

## Allocation synthetic conduits and fittings

### ROHRflex® Typen

### ROHRflex® Typen

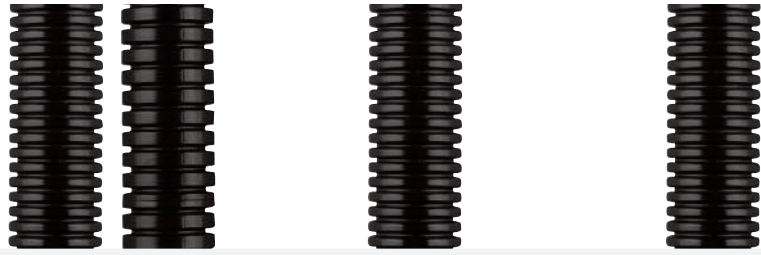

PA 6

PA 6, schmales und breites Profil

PA 6, fine and wide profile

PA 6 S

PA 6 schmales Profil

PA 6 fine profile

PA 6-D

PA 6, dickwandig schmales und breites Profil

PA 6, thick walled, fine and wide profile

### Zulassungen

### Approvals



### Abmessung AD

### Size range OD

10 - 54,5

10 - 54,5

10 - 54,5

Material

Polyamid 6

Polyamid 6

Polyamid 6

Material

Polyamide 6

Polyamide 6

Polyamide 6

Temperaturbereich

-40°C ... +120°C

-50°C ... +120°C

-40°C ... +120°C

Temperature range

Brandklasse

V0 (UL 94)

HB (UL 94)

V0 (UL 94)

Flammability class

### Einsatzbereich

### Applications

Maschinen-/Anlagenbau  
Machine/Plant Construction

•

•

•

Fahrzeugbau  
Vehicle construction

•

•

•

Schiffsbau  
Shipbuilding

•

•

•

Automation  
Automation

•

•

•

Elektroanlagen  
Electrical Installations

•

•

•



- P PG Gewinde
- M Metr. Gewinde
- C CTG-Gewinde
- N NPT-Gewinde
- P PG thread
- M Metric thread
- C CTG thread
- N NPT thread

### Verschraubungen

### Connectors



### Zubehör

### Accessories







PA 12

PA 12, schmales und breites Profil

PA 12, fine and wide profile



PA 12-D

PA 12, dickwandig schmales und breites Profil

PA 12, thick-walled fine and wide profile



PU

PU, schmales und breites Profil

PU, fine and wide profile



Multi

Kabelsammler PA 6

Cable collector PA 6



10 - 54,5

Polyamid 12  
Polyamide 12

-50°C ... +100°C

V2 (UL 94)

10 - 54,5

Polyamid 12  
Polyamide 12

-50°C ... +100°C

V2 (UL 94)

10 - 54,5

Polyurethan  
Polyurethane

-60°C ... +120°C

HB (UL 94)

LW / ID 70/95

Polyamid 6  
Polyamide 6

-40°C ... +120°C

HB (UL 94)

- 
- 
- 
- 
- 

- 
- 
- 
- 
- 

- 
- 
- 
- 
- 

- 
- 
- 
- 
- 



RQG2-M/P/N/U



RQK2-M/P



RQG3-M/P/U



RQGST-M



RQG1-S



Multi-GFP



RQB45-M/P/N



RQBK45-M/P



RQB1 45-M/P/N



RQW-M/P/C/N



RQW1-M/P/N



RQW-F



RQF2-M



Multi-WFP



FRH



OR-M/P



GM



GMK



STM-M/P



STK-M/P



ADM-PM/MP



ADK-PM/MP



BW-M/P



BWK-M/P



EWM-M/P



REK-M/P



REM-M/P



SKM

# Metallschutzschlauch nicht flüssigkeitsdicht

## Metal protective conduit not liquid-tight



SPR-AS



SPR-VA



FLEXAgraff® -AS

Profil doppelt gefalzt

Double overlapped profile



FLEXAgraff® -VA

Auf Anfrage / on request

Profil doppelt gefalzt

Double overlapped profile

### Zulassungen

#### Approvals



### Abmessung AD

#### Size range OD

10 - 56

10 - 56

10 - 56

10 - 56

Material  
Material

Stahl verzinkt  
Galvanized steel

Rostfreier Stahl  
Stainless steel

Stahl verzinkt  
Galvanized steel

Rostfreier Stahl  
Stainless steel

Temperaturbereich  
Temperature range

+250°C

+600°C

+250°C

+600°C

Schutzart  
Protection class

IP 40

IP 40

IP 40

IP 40

### Einsatzbereich

#### Applications

Maschinen-/Anlagenbau  
Machine/Plant Construction

•

•

•

•

Fahrzeugbau  
Vehicle construction

•

•

•

•

Schiffsbau  
Shipbuilding

•

•

•

•

Automation  
Automation

•

•

•

•

Elektroanlagen  
Electrical Installations

•

•

•

•

Sensortechnik  
Sensor Technology

•

•

•

•

Ex-Bereich  
Ex-area

•

•

•

•



### Verschraubungen

#### Conduit glands



US-M/P



US2-M



USDR-M



Kombi



USZ-EX-M



Adapter



USW-M/P





### SPR-EDU-AS

Umflechtung Stahl verzinkt

Galvanized steel wire braiding



10 - 56

Stahl verzinkt  
Galvanized steel

+250°C

IP 40

•

•

•

•

•

•

•

### FLEXAgraff®-CU-AS

Profil doppelt gefalzt  
Umflechtung Kupfer verzinkt

Double overlapped profile  
tinned copper wire braided



10 - 56

Stahl verzinkt  
Galvanized steel

+150°C

IP 40

•

•

•

•

•

•

### Zubehör Accessories



MSD



TED



EK



EEM

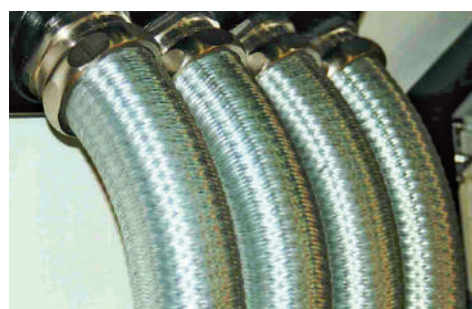

# Metallschutzschlauch flüssigkeitsdicht

## Metal protective conduit liquid tight



### SPR-PVC-AS

### SPR-PA Auf Anfrage /

### SPR-PU-AS

### FLEXAgraff® PU-AS

PVC-Mantel

PA-Mantel

PU-Mantel

Profil doppelt gefalzt  
PU-Mantel

PVC sheathing

PA sheathing

Oil-resitant  
PU sheathing

Double overlapped profile  
PU sheathing

### Zulassungen Approvals



### Abmessung AD Size range OD

10 - 56

10 - 56

10 - 56

10 - 56

Material  
Material

Stahl verzinkt  
Galvanized steel

Stahl verzinkt  
Galvanized steel

Stahl verzinkt  
Galvanized steel

Stahl verzinkt  
Galvanized steel

Temperaturbereich  
Temperature range

-25°C ... +90°C

-50°C ... +120°C

-50°C ... +100°C

-50°C ... +100°C

Schutzart  
Protection class

IP 68

IP 68

IP 68

IP 68

### Einsatzbereich Applications

Maschinen-/Anlagenbau  
Machine/Plant Construction

•

•

•

•

Fahrzeugbau  
Vehicle construction

•

•

•

•

Schiffsbau  
Shipbuilding

•

•

•

•

Automation  
Automation

•

•

•

•

Elektroanlagen  
Electrical Installations

•

•

•

•

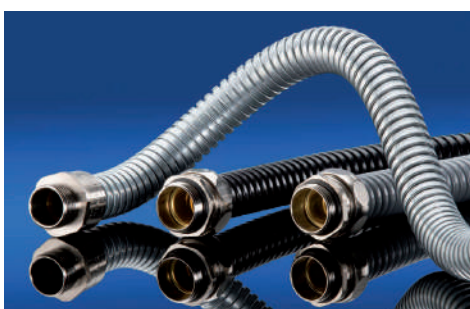

### Verschraubungen Conduit glands



US-M/P



US2-M



USDR-M



Kombi



EG-M/P



USZ-EX-M



Adapter



USW-M/P



EG-M/P



EW 45-M/P



EW 90-M/P



# Metallschutzschlauch flüssigkeitsdicht

## Metal protective conduit liquid tight



### FLEXAgraff® SI-ASF

Profil doppelt gefalzt  
Silikon-Mantel

Double overlapped  
profile  
silicone sheathing



### FLEXAgraff® CU-PU-AS

Profil doppelt gefalzt  
Umflechtung Kupfer verzinkt,  
PU-Mantel

Double overlapped profile  
tinned copper wire  
PU sheathing



### AIRflex® KUW-EDU

PVC-Mantel  
Umflechtung Stahl verzinkt

PVC sheathing  
galvanized steel  
wire braiding

### LIQUID-Tight UL-CSA

Kupfer-Erdleiter  
glatter PVC-Mantel

Copper ground lead  
PVC-sheathing



### LIQUID-Tight-EF

glatter PVC-Mantel

Smooth PVC-sheathing



10 - 56

Stahl verzinkt  
Galvanized steel

-50°C ... +180°C

IP 68

10 - 56

Stahl verzinkt  
Galvanized steel

-50°C ... +100°C

IP 68

14 - 56

Federstahldraht  
Spring steel wire

-25°C ... +90°C

IP 68

3/8" - 2"

Stahl verzinkt  
Galvanized steel

-20°C ... +90°C

IP 68

1/4" - 2"

Stahl verzinkt  
Galvanized steel

-25°C ... +90°C

IP 68

•

•

•

•

•

•

•

•

•

•

•

•

•

•

•

•

•

•

•

•

### Zubehör Accessories



MSD



TED



EK



EEM



# Schutzschlauch Auswahlkriterien

## Selection criteria for protective conduits

Schutzschlauch Protective conduit	Eigenschaften Properties																	
	Material Material	IP Schutzart IP Protection class	Temperatur min. [°C] Temperature min [°C]	Temperatur max. [°C] Temperature max [°C]	Temperatur kurzzeitig [°C] Temperature short term [°C]	Halogenfrei Free of halogen	UV - beständig [schwarz] UV - resistance [black]	Brandklasse [UL94] Flammability [UL94]	Druckfestigkeit Resistance to compression	Schlagfestigkeit Resistance to impact	Widerstand gegen Biegen Resistance to bending	Zugfestigkeit Tensile strength	Ölbeständigkeit Oil resistance	Lösungsmittelbeständigkeit Solvent resistance	Biegewechselfestigkeit Alternative bending strength	Flammbeständigkeit Flame resistance	Rauchgasdichte Density of smoke	Nicht - Flammausbreitend No - flame propagation
ROHRflex PA 6	PA6	IP68	-40°	+120°	+150°	•	•	VO									•	•
ROHRflex PA 6 S	PA6	IP68	-50°	+120°	+150°	•	•	HB									•	•
ROHRflex PA 6-D	PA6	IP68	-40°	+120°	+150°	•	•	VO									•	•
ROHRflex PA 12	PA12	IP68	-50°	+100°	+150°	•	•	V2									•	•
ROHRflex PA 12-D	PA12	IP68	-50°	+100°	+150°	•	•	V2									•	•
ROHRflex PU	PU	IP68	-60°	+120°		•	•	HB										•
ROHRflex PA 6-HT	PA6	IP68	-40°	+200°		•	•	V2									•	•
FLEXAzip	PA6		-40°	+105°	+120°	•	•	HB										•
ROHRflex MULTI - PA 6	PA6		-40°	+120°		•	•	HB										•
SPR-AS	Stn	IP40		+250°		•	•										•	
SPR-VA	V2A	IP40	-200°	+600°		•	•											
SPR-EDU-AS	Stn/Stn	IP40		+250°		•	•										•	
FLEXAgraff-AS	Stn	IP40		+250°		•	•										•	
FLEXAgraff-VA	V2A	IP40	-200°	+600°		•	•											
FLEXAgraff-CU-AS	Stn/CU	IP40		+150°		•	•										•	
SPR-PVC-AS	Stn/PVC	IP68	-25°	+90°	+100°												•	•
SPR-PA	Stn/PA	IP68	-50°	+120°	+150°	•	•										•	•
SPR-PU-AS	Stn/PU	IP68	-50°	+90°	+120°	•	•	V2									•	•
FLEXAgraff-PU-AS	Stn/PU	IP68	-50°	+90°	+120°	•	•	V2									•	•
FLEXAgraff-SI-ASF	Stn/Si	IP68	-50°	+120°		•	•										•	•
FLEXAgraff-CU-PU-AS	Stn/CU/PU	IP68	-50°	+90°	+120°	•	•	V2									•	•
LIQUID-TIGHT-EF	Stn/PVC	IP68	-25°	+90°	+100°												•	•
LIQUID-TIGHT-UL-CSA	Stn/PVC	IP68	-20°	+90°	+120°													•
AIRflex-KUW-PVC-AS	F/PVC	IP68	-25°	+90°	+100°													•
AIRflex-KUW-PU-AS	F/PU	IP68	-40°	+100°	+120°	•	•	V2									•	•
AIRflex-GRS	PVC	IP68	-25°	+90°	+100°													•
AGROflex PA	PA		-40°	+125°		•	•	V2									•	•
AGROflex PET	PET		-50°	+150°		•	•	V2									•	•
HG-CU	CU		-75°	+150°		•	•											•
PS-VA	V2A/Si/GL		-60°	+260°		•	•										•	•

Schutzschlauch Protective conduit	Schienenfahrzeuge Railway industry						Schiff Ship		Industrie Industry			Einsatzbereiche Applications											
	EN 45545-2	DIN 5510-2	NFF 16101 / 102	BS 6853	UNI CEI 11170	ASTM E162 / E662	Lloyd's Register	DNV	VDE Zulassung [EN 61386] VDE approval [EN 61386]	UR Zulassung [UL 1696] UR approval [UL 1696]	Rütteltest [EN IEC 61373] Vibration test [EN IEC 61373]	EMV Zulassung [EN 50289 1-6] EMC approval [EN 50289 1-6]	Maschinen- und Anlagenbau Machine and Plantconstructions	Fahrzeugbau Automotive	Schienenfahrzeuge Railway industry	Schiffsbau Shipbuilding	Automation Automation	Elektroanlagen Electrical installations	Medizintechnik Medical technology	Sensortechnik Senso technology	Ex-Bereich [EN 1127-1] Ex-area [EN 1127-1]	EMV-Anwendungen EMC-applications	Hochtemperaturbereiche High temperature areas
ROHRflex PA 6	HL3	•	•	•	•	•	•	•	•	•		•	•	•	•	•	•						
ROHRflex PA 6 S		•	•			•	•	•	•	•		•	•	•	•	•	•						
ROHRflex PA 6-D	HL3	•				•			•	•		•	•	•	•	•	•						
ROHRflex PA 12	HL2	•	•	•	•	•	•	•		•		•	•	•	•	•	•						
ROHRflex PA 12-D	HL2	•	•	•	•	•	•	•				•	•	•	•	•	•						
ROHRflex PU												•	•			•	•	•					
ROHRflex PA 6-HT									•			•	•				•						•
FLEXAzip												•					•	•					
ROHRflex MULTI - PA 6									•			•	•	•	•	•	•						
SPR-AS									•			•	•	•	•	•	•		•	•			
SPR-VA												•	•	•	•	•	•		•	•	•	•	•
SPR-EDU-AS									•			•	•	•	•	•	•			•	•		
FLEXAgraff-AS									•			•	•	•	•	•	•		•	•			•
FLEXAgraff-VA												•	•	•	•	•	•		•	•			•
FLEXAgraff-CU-AS									•		•	•	•	•	•	•	•			•	•		
SPR-PVC-AS									•			•	•	•	•	•	•		•				
SPR-PA									•		•	•	•	•	•	•	•		•				
SPR-PU-AS									•			•	•	•	•	•	•						
FLEXAgraff-PU-AS									•		•	•	•	•	•	•	•						
FLEXAgraff-SI-ASF									•			•	•	•	•	•	•						•
FLEXAgraff-CU-PU-AS									•		•	•	•	•	•	•	•				•		
LIQUID-TIGHT-EF									•			•	•	•	•	•	•						
LIQUID-TIGHT-UL-CSA									•			•	•	•	•	•	•						
AIRflex-KUW-PVC-AS									•	•		•	•	•	•	•	•		•				
AIRflex-KUW-PU-AS									•			•	•	•	•	•	•		•				
AIRflex-GRS									•			•	•	•	•	•	•		•				
AGROflex PA		•				•						•	•	•	•	•	•						
AGROflex PET	HL3	•				•						•	•	•	•	•	•						
HG-CU												•	•	•	•	•	•					•	
PS-VA												•	•	•	•	•	•	•	•				•



# Kunststoff Schutzschläuche

## Synthetic protective conduits

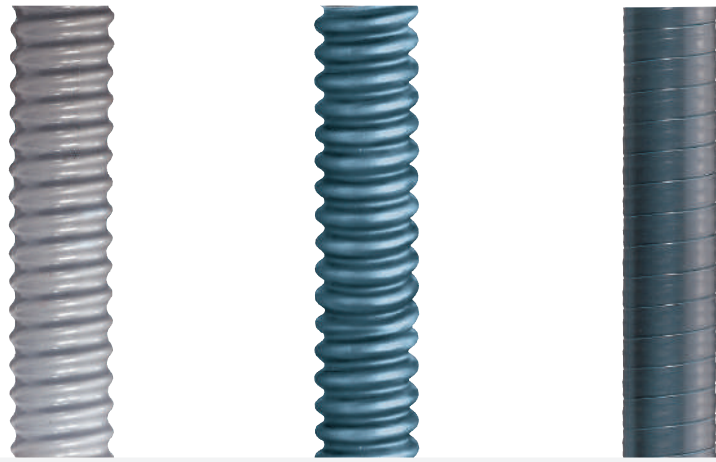

### AIRflex® KUW-PVC-AS

Federstahldrahtwendel

Inside helix of  
spring steel wire

### AIRflex® KUW-PU-AS

Federstahldrahtwendel

Inside helix of  
spring steel wire

### AIRflex®-GRS

Hartkunststoffwendel

Inside helix of  
spring steel wire

#### Zulassungen Approvals



#### Abmessung AD Size range OD

10 - 56

10 - 56

14 - 56

Material  
Material

PVC  
PVC

PU  
PU

PVC  
PVC

Temperaturbereich  
Temperature range

-25°C ... +90°C

-40°C ... +100°C

-25°C ... +90°C

Schutzart  
Protection class

IP 68

IP 68

IP 68

#### Einsatzbereich Applications

Maschinen-/Anlagenbau  
Machine/Plant Construction

•

•

•

Fahrzeugbau  
Vehicle construction

•

•

•

Automation  
Automation

•

•

•

Elektroanlagen  
Electrical Installations

•

•

•



#### Verschraubungen Conduit glands



USK-M/P



LKI-M/P









USDR-M



US2-M





<p>Kunststoff Schutzschläuche ROHRflex® PA 6 Synthetic protective conduits ROHRflex® PA 6</p>	 <b>18 - 21</b>	<b>1</b>
<p>Kunststoff Schutzschläuche ROHRflex® PA 12 Synthetic protective conduits ROHRflex® PA 12</p>	 <b>22 - 24</b>	<b>2</b>
<p>Kunststoff Schutzschläuche ROHRflex® PU Synthetic protective conduits ROHRflex® PU</p>	 <b>25</b>	<b>3</b>
<p>Kunststoff Kabelsammler ROHRflex® PA 6 Multi mit Flanschanschlüssen Synthetic cable collectors ROHRflex® PA 6 Multi with flange connectors</p>	 <b>26 - 27</b>	<b>4</b>
<p>Kunststoff Schutzschläuche FLEXAzip®, AGROflip B selbstschliessender Geflechschlauch und ROHRflex®-Duo geschlitzt Synthetic protection conduits FLEXAzip®, AGROflip B self-closing braided sleeve and ROHRflex®-Duo slotted</p>	 <b>28 - 29</b>	<b>5</b>
<p>Teilbare Verschraubung zu ROHRflex®-Duo Separable synthetic connector for ROHRflex®-Duo</p>	 <b>30</b>	<b>6</b>
<p>Kunststoff Schlauchhalter Synthetic conduit clamp</p>	 <b>31</b>	<b>7</b>

1  
2  
3  
4  
5  
6  
7  
8  
9  
10  
11  
12

# Schutzschläuche aus Kunststoff

## Synthetic protective conduits



**Kabelschutzschläuche aus Kunststoff** sind aus vielen Einsatzgebieten und Anwendungsbereichen nicht mehr wegzudenken. Parallelgewellte Kabelschutzschläuche aus unterschiedlichen Kunststoffen haben in den letzten Jahren ihren festen Platz erobert. Die grossen Vorteile sind die schnelle, gesteckte Montage auf die Schlauchverschraubungen und die leichte Trennbarkeit der Schläuche.

Die Schutzschläuche zeichnen sich durch ihr gutes Brandverhalten aus. Das Polyamid PA 6 und PA 12 erfüllen alle namhaften Brandschutz-Normen für Schienenfahrzeuge.

In der Praxis sind Kabelschutzschläuche im Maschinen- und Anlagenbau, in der Automation, der Energietechnik, im Fahrzeug- sowie im Schienenfahrzeugbau zu finden. Sie schützen Kabel und Datenleitungen zuverlässig vor äusseren Einflüssen ab und schützen Leitungen vor Bruch und Beschädigungen.

### Wichtigste Eigenschaften

- Hochflexibel
- Luft- und flüssigkeitsdicht
- Öl- und benzinbeständig
- Gute Laugen- und Säurenbeständigkeit
- Halogenfrei
- In schwarz UV beständig

### Brandschutz Zertifikate für Schienenfahrzeuge

- EN 45545-2

Bezüglich Zertifikate und Zulassungen von Kabelschutzschläuchen, wenden Sie sich bitte direkt an Ihren Ansprechpartner im Vertrieb.

### Normen

Für schutzisolierte Elektroinstallationen, geeignet für Montagen nach Anwendungsvorschriften EN / IEC 60204 im Maschinen- und Anlagenbau.

Besondere Anforderungen nach EN / IEC 61386-23 für flexible Installationsrohrsysteme zum Führen von Leitungen für elektrische Energie und für Informationen.

Many application areas are barely imaginable today without **synthetic cable conduits**. Corrugated cable conduits made of various plastic compounds have firmly established themselves in the past few years. Their major advantages are fast, plug-in assembly on conduit connectors and the ease with which conduits can be split.

These conduits also stand out due to their very good behaviour in fires. Polyamide PA 6 and PA 12 fulfil all well-known fire-protection standards for railway vehicles.

In practice, cable protective conduits can be found in the construction of machines and systems, in automation and power engineering applications as well as in the design of road and railway vehicles. They reliably shield data lines and other cables from external influences and also protect them from breakage and damage.

### Key properties

- Extremely flexible
- Impervious to air and liquids
- Oil and petrol resistant
- High resistance to acids and bases
- Halogen-free
- In black, UV-resistant

### Fire-protection certificates for railway vehicles

- EN 45545-2

For certificates and approvals for cable protection conduits, please contact your sales contact directly.

### Standards

For totally insulated electrical installations, suited for installation in machinery and systems according to application regulations in EN / IEC 60204.

Particular requirements according to EN / IEC 61386-23 for flexible conduit systems for the cable management of electrical power and data lines.





**Kabelschutzschläuche ROHRflex® aus Kunststoff Polyamid PA 6** sind in vielen Anwendungen im Maschinen- und Anlagenbau, Automation, Elektroanlagen, Fahrzeugbau und Schienenfahrzeugen anzutreffen. Das leichte, flexible Wellrohr ist für geringere mechanische Belastungen geeignet.

Gute mechanische Eigenschaften, Flexibilität, Abrieb- und Ermüdungsbeständigkeit sowie eine hohe Widerstandsfähigkeit gegenüber Ölen und Chemikalien gehören zu den Grundanforderungen die der Kunststoff Polyamid PA 6 erfüllt.

Für den Einsatz in der Bahnindustrie werden die wichtigsten Brandschutznormen für Schienenfahrzeuge erfüllt.

**ROHRflex® protective conduits for cables made of Polyamide PA 6** compounds can be found in many applications such as the construction of machines and systems, in automation and electric systems as well as street and railway vehicles. This light, flexible corrugated tubing is intended for small mechanical loads.

Excellent mechanical properties along with flexibility, abrasion and fatigue resistance as well as good ability to withstand the effects of oils and chemicals are among the basic requirements fulfilled by Polyamide PA 6 compounds.

When used in the railroad industry, they meet the most important fire-protection standards for railway vehicles.



Für dynamische Anwendungen eignen sich besonders die **Kabelschutzschläuche ROHRflex® aus Kunststoff Polyamid PA 12**. Aufgrund ihrer Flexibilität halten sie auch in Umgebungen mit ständiger Bewegung stand, so lassen sie sich auch in Robotern, Eisenbahnen und im Maschinen- und Anlagenbau einsetzen.

Gute bis sehr gute Beständigkeit gegen Fette, Öle, Kraftstoffe, Hydraulikflüssigkeiten, viele Lösemittel sowie Salzlösungen und andere Chemikalien.

Für den Einsatz in Schienenfahrzeugen ist besonders die hohe Schlagzähigkeit und Kerbschlagzähigkeit, selbst weit unter dem Gefrierpunkt, entscheidend.

**ROHRflex® protective conduits for cables made of Polyamide PA 12** compounds are particularly well suited for dynamic applications. Due to their flexibility, they stand up even in environments with constant motion and thus can be used to advantage in robots, railroads and in the construction of machines and systems.

They feature high to very high ability to withstand the effects of grease, oil, fuel, hydraulic fluid, many solvents and saline solutions plus other chemicals.

Their high impact and notched impact strengths, even when far below the freezing point, are decisive factors for use in railway vehicles.



Für mehr Flexibilität bei der Arbeit eignet sich ein in Längsrichtung **geschlitzter Kabelschutzschlauch oder ein selbstschliessender Geflechschlauch aus Kunststoff**. Dieser lässt sich jederzeit öffnen und wieder schliessen.

Bei der Nachinstallation oder im Service kann der Kabelschutzschlauch nachträglich in Schaltschränke oder im Maschinen- und Anlagenbau mit montierten Kabeln und Steckern eingebaut werden.

Dieser Kabelschutzschlauch gewinnt auch im Fahrzeugbau und in der Gebäudeinstallation immer mehr an Bedeutung.

**Synthetic protective conduits longitudinally slotted or self-closing braided sleeveings** provide additional flexibility in your work. They can be opened up and reclosed again at any time.

Later, during retrofits or servicing, cable conduit can be installed in electrical cabinets or in machines and systems along with pre-assembled cables and connectors.

This cable conduit is also taking on a more important role in vehicle design and building installations.

# Kunststoff Schutzschlauch ROHRflex® PA 6

## Synthetic protective conduits ROHRflex® PA 6

### Schmales Profil | Fine profile

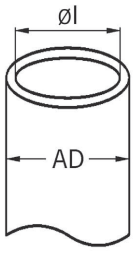

Material: Polyamid PA 6  
 Brandklasse: V0 (UL 94)  
 Eigenschaften: Luft- und flüssigkeitsdicht, ölbeständig bis +80°C, benzinbeständig, weitgehend säure- und lösungsmittelbeständig, silikon- und cadmiumfrei, halogenfrei, selbstverlöschend. In schwarz UV-beständig.  
 Einsatzbereich: Maschinen- und Anlagenbau, Fahrzeugbau, Schienenfahrzeuge im Innenbereich, Schiffsbau, Automation, Elektroanlagen  
 Schutzart: IP 68  
 Einsatztemperatur: -40°C / +120°C / ^ +150°C

Material: Polyamide PA 6  
 Fire classification: V0 (UL 94)  
 Properties: Air- and liquid-tight, oil resistant up to +80°C, petrol resistant, basically resistant to acids and solvents, free of silicone, free of cadmium, halogen-free, self extinguishing, black tubing is UV-resistant.  
 Application: Machine and plant constructions, automotive, rail vehicles inside applications, shipbuilding, automation, electrical installations  
 Protection class: IP 68  
 Temperature range: -40°C / +120°C / ^ +150°C



ROHRflex® PA 6 Schwarz				ROHRflex® PA 6 Black	
AD mm	Øl mm	R±10% stat mm	R±10% dyn mm	Art.-Nr.   Art. No.	
10.0	6.5	13	35	0233.202.006	50
13.0	10.0	20	45	0233.202.010	50
15.8	12.0	35	55	0233.202.012	50
18.5	14.3	40	65	0233.202.014	50
21.2	16.5	45	75	0233.202.016	50
28.5	23.0	55	100	0233.202.023	50
34.5	29.0	65	120	0233.202.029	25
42.5	36.0	90	150	0233.202.036	25
54.5	48.0	100	190	0233.202.048	25

Auf Anfrage lieferbar: Kunststoff Schutzschlauch ROHRflex® PA 6-HT für hohe Temperaturen bis +200°C  
 Available on request: Synthetic protective conduits ROHRflex® PA 6-HT for high temperature applications +200°C



ROHRflex® PA 6 Grau				ROHRflex® PA 6 Grey	
AD mm	Øl mm	R±10% stat mm	R±10% dyn mm	Art.-Nr.   Art. No.	
10.0	6.5	13	35	0233.201.006	50
13.0	10.0	20	45	0233.201.010	50
15.8	12.0	35	55	0233.201.012	50
18.5	14.3	40	65	0233.201.014	50
21.2	16.5	45	75	0233.201.016	50
28.5	23.0	55	100	0233.201.023	50
34.5	29.0	65	120	0233.201.029	25
42.5	36.0	90	150	0233.201.036	25
54.5	48.0	100	190	0233.201.048	25

### Klassifizierung nach / Classification according to EN / IEC 61386 part 23

Schlüssel siehe Zusatzinformationen / For key see additional information

AD	10.0 - 21.2 mm	2-3-2-2-4-0-6-7-/-1-1-2
AD	28.5 - 34.5 mm	3-4-2-2-4-0-6-7-/-2-1-3
AD	42.5 - 54.5 mm	3-4-2-2-4-0-6-7-/-3-1-3

# Kunststoff Schutzschlauch ROHRflex® PA 6-B

## Synthetic protective conduits ROHRflex® PA 6-B

Breites Profil | Coarse profile

Material: Polyamid PA 6  
 Brandklasse: V0 (UL 94)  
 Eigenschaften: Luft- und flüssigkeitsdicht, ölbeständig bis +80°C, benzinbeständig, weitgehend säure- und lösungsmittelbeständig, silikon- und cadmiumfrei, halogenfrei, selbstverlöschend. In schwarz UV-beständig.  
 Einsatzbereich: Maschinen- und Anlagenbau, Fahrzeugbau, Schienenfahrzeuge im Innenbereich, Schiffsbau, Automation, Elektroanlagen  
 Schutzart: IP 68  
 Einsatztemperatur: -40°C / +120°C /  $\wedge$  +150°C

Material: Polyamide PA 6  
 Fire classification: V0 (UL 94)  
 Properties: Air- and liquid-tight, oil resistant up to +80°C, petrol resistant, basically resistant to acids and solvents, free of silicone, free of cadmium, halogen-free, self extinguishing, black tubing is UV-resistant.  
 Application: Machine and plant constructions, automotive, rail vehicles inside applications, shipbuilding, automation, electrical installations  
 Protection class: IP 68  
 Temperature range: -40°C / +120°C /  $\wedge$  +150°C

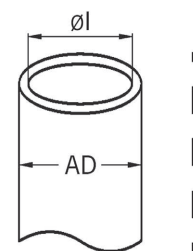

ROHRflex® PA 6-B Schwarz				ROHRflex® PA 6-B Black	
AD mm	øl mm	R±10% stat mm	R±10% dyn mm	Art.-Nr.   Art. No.	
21.2	15.5	45	75	0233.232.016	50
28.5	22.0	55	100	0233.232.023	50
34.5	27.5	65	120	0233.232.029	25
42.5	35.5	90	150	0233.232.036	25
54.5	47.0	100	190	0233.232.048	25



### Klassifizierung nach / Classification according to EN / IEC 61386 part 23

Schlüssel siehe Zusatzinformationen / For key see additional information

AD	10.0 - 21.2 mm	2-3-2-2-4-0-6-7-/-1-1-2
AD	28.5 - 34.5 mm	3-4-2-2-4-0-6-7-/-2-1-3
AD	42.5 - 54.5 mm	3-4-2-2-4-0-6-7-/-3-1-3



# Kunststoff Schutzschlauch ROHRflex® PA 6-S

## Synthetic protective conduits ROHRflex® PA 6-S

### Schmales Profil | Fine profile

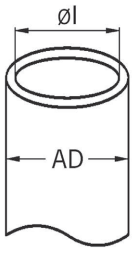

Material: Polyamid PA 6  
 Brandklasse: HB (UL 94)  
 Eigenschaften: Luft- und flüssigkeitsdicht, ölbeständig bis +80°C, benzinbeständig, weitgehend säure- und lösungsmittelbeständig, silikon- und cadmiumfrei, halogenfrei, selbstverlöschend. In schwarz UV-beständig.  
 Einsatzbereich: Maschinen- und Anlagenbau, Fahrzeugbau, Schiffsbau, Automation, Elektroanlagen  
 Schutzart: IP 68  
 Einsatztemperatur: -40°C / +120°C / ^ +150°C

Material: Polyamide PA 6  
 Fire classification: HB (UL 94)  
 Properties: Air- and liquid-tight, oil resistant up to +80°C, petrol resistant, basically resistant to acids and solvents, free of silicone, free of cadmium, halogen-free, self extinguishing, black tubing is UV-resistant.  
 Application: Machine and plant constructions, automotive, shipbuilding, automation, electrical installations  
 Protection class: IP 68  
 Temperature range: -40°C / +120°C / ^ +150°C



ROHRflex® PA 6-S Schwarz				ROHRflex® PA 6-S Black	
AD mm	Øl mm	R±10% stat mm	R±10% dyn mm	Art.-Nr.   Art. No.	
10.0	6.5	13	35	0233.209.006	50
13.0	10.0	20	45	0233.209.010	50
15.8	12.0	35	55	0233.209.012	50
18.5	14.3	40	65	0233.209.014	50
21.2	16.5	45	75	0233.209.016	50
28.5	23.0	55	100	0233.209.023	50
34.5	29.0	65	120	0233.209.029	25
42.5	36.0	90	150	0233.209.036	25
54.5	48.0	100	190	0233.209.048	25



ROHRflex® PA 6-S Grau				ROHRflex® PA 6-S Grey	
AD mm	Øl mm	R±10% stat mm	R±10% dyn mm	Art.-Nr.   Art. No.	
10.0	6.5	13	35	0232.201.006	50
13.0	10.0	20	45	0232.201.010	50
15.8	12.0	35	55	0232.201.012	50
18.5	14.3	40	65	0232.201.014	50
21.2	16.5	45	75	0232.201.016	50
28.5	23.0	55	100	0232.201.023	50
34.5	29.0	65	120	0232.201.029	25
42.5	36.0	90	150	0232.201.036	25
54.5	48.0	100	190	0232.201.048	25



### Klassifizierung nach / Classification according to EN / IEC 61386 part 23

Schlüssel siehe Zusatzinformationen / For key see additional information

AD	10.0 - 21.2 mm	2-3-2-2-4-0-6-7/-1-1-2
AD	28.5 - 34.5 mm	3-4-2-2-4-0-6-7/-2-1-3
AD	42.5 - 54.5 mm	3-4-2-2-4-0-6-7/-3-1-3

# Kunststoff Schutzschlauch ROHRflex® PA 6-D

## Synthetic protective conduits ROHRflex® PA 6-D

### Schmales Profil, dickwandig | Fine profile, thick-walled

Material: Polyamid PA 6  
 Brandklasse: V0 (UL 94)  
 Eigenschaften: Schwere Ausführung mit höherer Querdruckfestigkeit, luft- und flüssigkeitsdicht, ölbeständig bis +80°C, benzinbeständig, weitgehend säure- und lösungsmittelbeständig, silikon- und cadmiumfrei, halogenfrei, selbstverlöschend. In schwarz UV-beständig.  
 Einsatzbereich: Maschinen- und Anlagenbau, Fahrzeugbau, Schienenfahrzeuge im Innenbereich, Schiffsbau, Automation, Elektroanlagen  
 Schutzart: IP 68  
 Einsatztemperatur: -40°C / +120°C /  $\wedge$  +150°C

Material: Polyamide PA 6  
 Fire classification: V0 (UL 94)  
 Properties: Strong version with enhanced lateral compressive strength, air- and liquid-tight, oil resistant up to +80°C, petrol resistant, basically resistant to acids and solvents, free of silicone, free of cadmium, halogen-free, self extinguishing, black tubing is UV-resistant.  
 Application: Machine and plant constructions, automotive, rail vehicles inside applications, shipbuilding, automation, electrical installations  
 Protection class: IP 68  
 Temperature range: -40°C / +120°C /  $\wedge$  +150°C

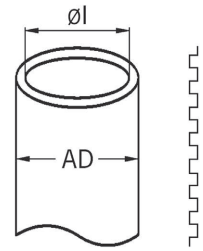

ROHRflex® PA 6-D Schwarz				ROHRflex® PA 6-D Black	
AD mm	Øl mm	R±10% stat mm	R±10% dyn mm	Art.-Nr.   Art. No.	
10.0	6.0	15	35	0237.202.006	50
13.0	9.5	25	45	0237.202.010	50
15.8	11.5	35	55	0237.202.012	50
18.5	13.8	40	65	0237.202.014	50
21.2	16.0	50	75	0237.202.016	50
28.5	22.5	60	100	0237.202.023	50
34.5	28.5	70	120	0237.202.029	25
42.5	35.5	100	150	0237.202.036	25
54.5	47.5	110	190	0237.202.048	25



### Breites Profil, dickwandig | Coarse profile, thick-walled



ROHRflex® PA 6-DB Schwarz				ROHRflex® PA 6-DB Black	
AD mm	Øl mm	R±10% stat mm	R±10% dyn mm	Art.-Nr.   Art. No.	
21.2	16.0	50	75	0237.232.016	50
28.5	22.5	60	100	0237.232.023	50
34.5	28.4	70	120	0237.232.029	25
42.5	35.5	100	150	0237.232.036	25
54.5	47.5	110	190	0237.232.048	25



#### Klassifizierung nach / Classification according to EN / IEC 61386 part 23

Schlüssel siehe Zusatzinformationen / For key see additional information

AD	10.0 - 21.2 mm	2-3-2-2-4-0-6-7-/-1-1-2
AD	28.5 - 34.5 mm	3-4-2-2-4-0-6-7-/-2-1-3
AD	42.5 - 54.5 mm	3-4-2-2-4-0-6-7-/-3-1-3

# Kunststoff Schutzschlauch ROHRflex® PA 12

## Synthetic protective conduits ROHRflex® PA 12

### Schmales Profil | Fine profile

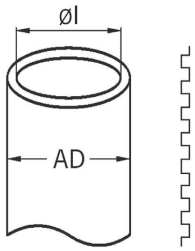

Material: Polyamid PA 12  
 Brandklasse: V2 (UL 94)  
 Eigenschaften: Hohe Wechselbiegefestigkeit, gute Isolationseigenschaften, luft- und flüssigkeitsdicht, ölbeständig, benzinbeständig, weitgehend säure- und lösungsmittelbeständig, silikon- und cadmiumfrei, halogenfrei, selbstverlöschend. In schwarz UV-beständig.  
 Einsatzbereich: Maschinen- und Anlagenbau, Fahrzeugbau, Schienenfahrzeuge im Aussenbereich, Schiffsbau, Automation, Elektroanlagen  
 Schutzart: IP 68  
 Einsatztemperatur: -50°C / +100°C / ^ +130°C

Material: Polyamide PA 12  
 Fire classification: V2 (UL 94)  
 Properties: High reciprocal flexural resistance, improved insulation properties, air- and liquid-tight, oil resistant, petrol resistant, basically resistant to acids and solvents, free of silicone, free of cadmium, halogen-free, self extinguishing. Black tubing is UV-resistant.  
 Application: Machine and plant constructions, automotive, rail vehicles outside applications, shipbuilding, automation, electrical installations  
 Protection class: IP 68  
 Temperature range: -50°C / +100°C / ^ +130°C



ROHRflex® PA 12 Schwarz				ROHRflex® PA 12 Black		
AD mm	Øl mm	R±10% stat mm	R±10% dyn mm	Art.-Nr.   Art. No.	Icon	
10.0	6.5	13	35	0236.202.006	50	
13.0	10.0	15	45	0236.202.010	50	
15.8	12.0	22	55	0236.202.012	50	
18.5	14.3	27	65	0236.202.014	50	
21.2	16.5	35	75	0236.202.016	50	
28.5	23.0	45	100	0236.202.023	50	
34.5	29.0	50	120	0236.202.029	25	
42.5	36.0	80	150	0236.202.036	25	
54.5	48.0	100	190	0236.202.048	25	

Auf Anfrage lieferbar: Kunststoff Schutzschlauch ROHRflex® PA 12 in orange für Elektrofahrzeuge  
 Available on request: Synthetic protective conduits ROHRflex® PA 12 in orange for electric vehicles



ROHRflex® PA 12 Grau				ROHRflex® PA 12 Grey		
AD mm	Øl mm	R±10% stat mm	R±10% dyn mm	Art.-Nr.   Art. No.	Icon	
10.0	6.5	13	35	0236.201.006	50	
13.0	10.0	15	45	0236.201.010	50	
15.8	12.0	22	55	0236.201.012	50	
18.5	14.3	27	65	0236.201.014	50	
21.2	16.5	35	75	0236.201.016	50	
28.5	23.0	45	100	0236.201.023	50	
34.5	29.0	50	120	0236.201.029	25	
42.5	36.0	80	150	0236.201.036	25	
54.5	48.0	100	190	0236.201.048	25	

### Klassifizierung nach / Classification according to EN / IEC 61386 part 23

Schlüssel siehe Zusatzinformationen / For key see additional information

AD 10.0 - 21.2 mm	2-4-3-4-4-2-6-7-/-1-1-2
AD 28.5 - 54.5 mm schwarz/black	2-4-3-4-4-2-6-7-/-2-1-3
AD 28.5 - 54.5 mm grau/grey	2-4-5-4-4-2-6-7-/-2-1-3



# Kunststoff Schutzschlauch ROHRflex® PA 12-B

## Synthetic protective conduits ROHRflex® PA 12-B

Breites Profil | Wide profile

Material: Polyamid PA 12  
 Brandklasse: V2 (UL 94)  
 Eigenschaften: Hohe Wechselbiegefestigkeit, gute Isolationseigenschaften, luft- und flüssigkeitsdicht, ölbeständig, benzinbeständig, weitgehend säure- und lösungsmittelbeständig, silikon- und cadmiumfrei, halogenfrei, selbstverlöschend. In schwarz UV-beständig.  
 Einsatzbereich: Maschinen- und Anlagenbau, Fahrzeugbau, Schienenfahrzeuge im Aussenbereich, Schiffsbau, Automation, Elektroanlagen  
 Schutzart: IP 68  
 Einsatztemperatur: -50°C / +100°C /  $\wedge$  +130°C

Material: Polyamide PA 12  
 Fire classification: V2 (UL 94)  
 Properties: High reciprocal flexural resistance, improved insulation properties, air- and liquid-tight, oil resistant, petrol resistant, basically resistant to acids and solvents, free of silicone, free of cadmium, halogen-free, self extinguishing. Black tubing is UV-resistant.  
 Application: Machine and plant constructions, automotive, rail vehicles outside applications, shipbuilding, automation, electrical installations  
 Protection class: IP 68  
 Temperature range: -50°C / +100°C /  $\wedge$  +130°C

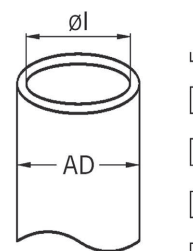

ROHRflex® PA 12-B  
 Schwarz

ROHRflex® PA 12-B  
 Black

AD mm	øl mm	R±10% stat mm	R±10% dyn mm	Art.-Nr.   Art. No.	
21.2	15.5	45	75	0236.232.016	50
28.5	22.0	55	100	0236.232.023	50
34.5	27.5	65	120	0236.232.029	25
42.5	35.5	90	150	0236.232.036	25
54.5	47.0	100	190	0236.232.048	25



Auf Anfrage lieferbar:  
 ROHRflex® PA 12-F schmales und breites Profil für Schienenfahrzeuge nach EN 45545-2 mit HL3

Available on request:  
 ROHRflex® PA 12-F fine and coarse profile for rail vehicle according to EN 45545-2 with HL3

### Klassifizierung nach / Classification according to EN / IEC 61386 part 23

Schlüssel siehe Zusatzinformationen / For key see additional information

AD 10.0 - 21.2 mm 2-4-3-4-4-2-6-7-/-1-1-2  
 AD 28.5 - 54.5 mm schwarz/black 2-4-3-4-4-2-6-7-/-2-1-3

# Kunststoff Schutzschlauch ROHRflex® PA 12-D

## Synthetic protective conduits ROHRflex® PA 12-D

### Schmales Profil, dickwandig | Fine profile, thick-walled

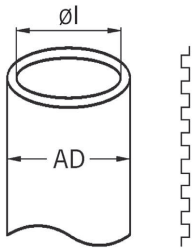

Material: Polyamid PA 12  
 Brandklasse: V2 (UL 94)  
 Eigenschaften: Hohe Wechselbiegefestigkeit, gute Isolationseigenschaften, luft- und flüssigkeitsdicht, ölbeständig, benzinbeständig, weitgehend säure- und lösungsmittelbeständig, silikon- und cadmiumfrei, halogenfrei, selbstverlöschend. In schwarz UV-beständig.

Einsatzbereich: Maschinen- und Anlagenbau, Fahrzeugbau, Schienenfahrzeuge im Aussenbereich, Schiffsbau, Automation, Elektroanlagen

Schutzart: IP 68  
 Einsatztemperatur: -50°C / +100°C / ^ +130°C

Material: Polyamide PA 12  
 Fire classification: V2 (UL 94)  
 Properties: High reciprocal flexural resistance, improved insulation properties, air- and liquid-tight, oil resistant, petrol resistant, basically resistant to acids and solvents, free of silicone, free of cadmium, halogen-free, self extinguishing. Black tubing is UV-resistant.

Application: Machine and plant constructions, automotive, rail vehicles outside applications, shipbuilding, automation, electrical installations

Protection class: IP 68  
 Temperature range: -50°C / +100°C / ^ +130°C



ROHRflex® PA 12-D Schwarz				ROHRflex® PA 12-D Black	
AD mm	Øl mm	R±10% stat mm	R±10% dyn mm	Art.-Nr.   Art. No.	
10.0	6.0	15	35	0258.202.006	50
13.0	9.5	25	45	0258.202.010	50
15.8	11.5	35	55	0258.202.012	50
21.2	16.0	50	75	0258.202.016	50

### Breites Profil, dickwandig | Coarse profile, thick-walled



ROHRflex® PA 12-DB Schwarz				ROHRflex® PA 12-DB Black	
AD mm	Øl mm	R±10% stat mm	R±10% dyn mm	Art.-Nr.   Art. No.	
21.2	15.0	50	110	0258.232.016	50
28.5	21.5	60	120	0258.232.023	50
34.5	27.0	70	140	0258.232.029	25
42.5	35.0	80	170	0258.232.036	25
54.5	46.5	100	190	0258.232.048	25



Auf Anfrage lieferbar:  
 ROHRflex® PA 12-F dickwandig, schmales und breites Profil für Schienenfahrzeuge nach EN 45545-2 mit HL3

Available on request:  
 ROHRflex® PA 12-F thick-walled, fine and coarse profile for rail vehicle according to EN 45545-2 with HL3

### Klassifizierung nach / Classification according to EN / IEC 61386 part 23

Schlüssel siehe Zusatzinformationen / For key see additional information

AD	10.0 mm	2-3-4-4-2-6-7-/-1-1-1
AD	13.0 - 21.2 mm	2-3-4-4-2-6-7-/-2-1-2
AD	21.2 - 42.5 mm	3-4-4-4-2-6-7-/-3-1-3
AD	54.5 mm	2-4-4-4-2-6-7-/-3-1-3

# Kunststoff Schutzschlauch ROHRflex® PU

## Synthetic protective conduits ROHRflex® PU

### Schmales Profil | Fine profile

Material: Polyurethan  
 Brandklasse: HB (UL 94)  
 Eigenschaften: Luft- und flüssigkeitsdicht, öl-, benzin und fettbeständig, weitgehend säure- und lösungsmittelbeständig, silikon- und cadmiumfrei, halogenfrei, hohe Zähigkeit und Abriebbeständigkeit, sehr flexibel, mikrobenebenständig, UV-beständig

Einsatzbereich: Maschinen- und Anlagenbau, Fahrzeugbau, Schiffsbau, Automation, Elektroanlagen

Schutzart: IP 68  
 Einsatztemperatur: -40°C / +120°C

Material: Polyurethane  
 Fire classification: HB (UL 94)  
 Properties: Airtight and waterproof, resistant to oil, resistant to benzene and fats, widely resistant to acids and solvents, free of silicone, cadmium and halogen, elevated tenacity and resistance to abrasion, very flexible, resistant to microbes and UV rays

Application: Machine and plant constructions, automotive, shipbuilding, automation, electrical installations

Protection class: IP 68  
 Temperature range: -40°C / +120°C

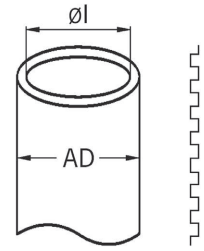

ROHRflex® PU Schwarz				ROHRflex® PU Black		
AD mm	Øl mm	R±10% stat mm	R±10% dyn mm	Art.-Nr.   Art. No.		
10.0	6.5	13	35	0289.902.006	50	
13.0	8.8	15	40	0289.902.010	50	
15.8	11.4	22	55	0289.932.012	50	



### Breites Profil | Wide profile

ROHRflex® PU Schwarz				ROHRflex® PU Black		
AD mm	Øl mm	R±10% stat mm	R±10% dyn mm	Art.-Nr.   Art. No.		
21.2	15.2	35	75	0289.932.016	50	
28.5	22.0	45	100	0289.932.023	50	
34.5	27.5	50	120	0289.932.029	25	
42.5	35.5	80	150	0289.932.036	25	
54.5	47.0	100	190	0289.932.048	25	



#### Klassifizierung nach / Classification according to EN / IEC 61386 part 23

Schlüssel siehe Zusatzinformationen / For key see additional information

AD 10.0 - 21.2 mm -/-5-4-4-2-6-7-/-1-/-

AD 28.5 - 54.5 mm -/-5-4-4-2-6-7-/-1-/-

# Kunststoff Kabelsammler ROHRflex® PA 6 Multi

## Synthetic cable collector ROHRflex® PA 6 Multi

### Breites Profil | Wide profile

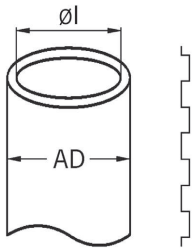

Material: Polyamid PA 6  
 Brandklasse: HB (UL 94)  
 Eigenschaften: Trittfest, flüssigkeitsdicht, ölbeständig bis +80°C, benzinbeständig, weitgehend säure- und lösungsmittelbeständig, flammwidrig  
 Einsatzbereich: Maschinen- und Anlagenbau, Fahrzeugbau, Schiffsbau, Automation, Elektroanlagen  
 Schutzart: IP 68  
 Einsatztemperatur: -40°C / +120°C / ^ +150°C

Material: Polyamide PA 6  
 Fire classification: HB (UL 94)  
 Properties: Non-crush, liquid-tight, oil resistant up to +80°C, petrol resistant, basically resistant to acids and solvents, flame retardant  
 Application: Machine and plant constructions, automotive, shipbuilding, automation, electrical installations  
 Protection class: IP 68  
 Temperature range: -40°C / +120°C / ^ +150°C



ROHRflex® PA 6 Multi  
Schwarz

AD mm	ØA mm	ØI mm	R±10% stat mm	R±10% dyn mm	Art.-Nr.   Art. No.	
56	67.2	56.3	130	270	<b>0206.202.056</b>	10
70	79.2	66.5	170	350	<b>0206.202.070</b>	10
95	106.0	91.0	225	450	<b>0206.202.095</b>	10



ROHRflex® PA 6 Multi  
Grau

AD mm	ØA mm	ØI mm	R±10% stat mm	R±10% dyn mm	Art.-Nr.   Art. No.	
70	79.2	66.5	170	350	<b>0206.201.070</b>	10
95	106.0	91.0	225	450	<b>0206.201.095</b>	10

### Kunststoff Reparaturmuffe RQK-GW | Synthetic repair sleeve RQK-GW

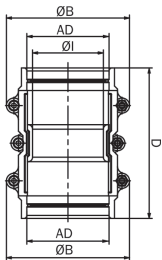

Material: Flexamid V0 (HL 3)  
 Dichtung: TPE  
 Brandklasse: V0 (UL 94)  
 Eigenschaften: Reparaturmuffe bestehend aus zwei Halbschalen, die nachträglich durch Schrauben verbunden und geschlossen werden. Halogenfrei  
 Einsatzbereich: Für nachträgliche Installation  
 Schutzart: IP 68 / IP 69  
 Einsatztemperatur: -40°C / +120°C

Material: Flexamid V0 (HL 3)  
 Seal: DPE  
 Fire classification: V0 (UL 94)  
 Properties: Properties: Repair sleeve consisting of two half shells, which are subsequently connected and closed by screws. Halogen-free  
 Application: For additional installation  
 Protection class: IP 68 / IP 69  
 Temperature range: -40°C / +120°C



Reparaturmuffe  
Schwarz

AD mm	ØA mm	ØI mm	D mm	Art.-Nr.   Art. No.	
42.5	33	71	80	<b>5609.042.242</b>	1
54.5	47	82	100	<b>5609.054.254</b>	1

EN 45545-2  
HL 3



# Flanschanschluss ROHRflex® Multi Flange connector ROHRflex® Multi

## Flanschanschluss gerade ROHRflex® Multi-GFP | Straight flange connector ROHRflex® Multi-GFP

Material: Polyamid  
Eigenschaften: Integrierte Dichtnut, silikon- und cadmiumfrei, halogenfrei, selbstverlöschend.  
Einsatzbereich: Maschinen- und Anlagenbau, Fahrzeugbau, Schiffsbau, Automation, Elektroanlagen  
Schutzart: IP 54  
Hinweis: Mit Zusatzdichtung IP 68 / IP 69K  
Einsatztemperatur: -40°C / +120°C

Material: Polyamide  
Properties: Integrated sealing slot, free of silicone, free of cadmium, halogen-free, self extinguishing.  
Application: Machine and plant constructions, automotive, shipbuilding, automation, electrical installations  
Protection class: IP 54  
Note: With additional sealing IP 68 / IP 69K  
Temperature range: -40°C / +120°C

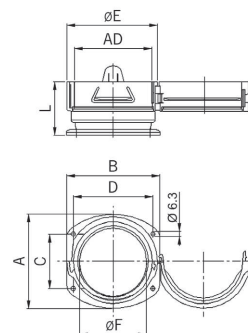

Schwarz								Black		Art.-Nr.   Art. No.	
AD mm	A mm	B mm	C mm	D	ØE mm	ØF mm	L mm				
70	94	96	60	80	96	68	65.5	5032.206.070	1		
95	120	126	74	108	123	85	70.5	5032.206.095	1		



Grau								Grey		Art.-Nr.   Art. No.	
AD mm	A mm	B mm	C mm	D	ØE mm	ØF mm	L mm				
70	94	96	60	80	96	68	65.5	5032.006.070	1		
95	120	126	74	108	123	85	70.5	5032.006.095	1		



## Flanschanschluss 90° ROHRflex® Multi-WFP | 90° elbow flange connector ROHRflex® Multi-WFP

Schwarz							Black		Art.-Nr.   Art. No.	
AD mm	A mm	B mm	C mm	D	K mm	L mm				
70	94	96	60	80	105	109	5032.207.070	1		
95	120	126	74	108	130	142	5032.207.095	1		



Grau							Grey		Art.-Nr.   Art. No.	
AD mm	A mm	B mm	C mm	D	K mm	L mm				
70	94	96	60	80	105	109	5032.007.070	1		
95	120	126	74	108	130	142	5032.007.095	1		



## Spezialdichtung zu ROHRflex®-Multi Verschraubungen | Special sealing for ROHRflex®-Multi connectors

Material: TPE  
Schutzart: IP 68 / IP 69K

Material: TPE  
Protection class: IP 68 / IP 69K

AD mm	<b>i</b> info	Art.-Nr.   Art. No.	
70	5032.xxx.070	5032.211.070	1
95	5032.xxx.095	5032.211.095	1



# Kunststoff Schutzschlauch geschlitzt

## Synthetic protection conduits slotted

### Kunststoff Schutzschlauch FLEXAzip® geschlitzt | Synthetic protection conduits FLEXAzip® slotted

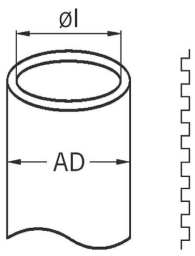

Material: Polyamid PA 6  
 Brandklasse: HB (UL 94)  
 Aufbau: 10 m Vollkunststoff-Wellschlauch, 10 m Verschlussprofil, 1 Stk. Montagewerkzeug  
 Einsatzbereich: Problemloses Einziehen von vorkonfektionierten Kabeln, für nachträgliche Installation  
 Eigenschaften: Halogenfrei  
 Schutzart: IP 54  
 Einsatztemperatur: -40°C / +105°C

Material: Polyamide PA 6  
 Fire classification: HB (UL 94)  
 Construction: 10 m synthetic corrugated conduit, 10 m closing profile, 1 pcs. mounting tool  
 Application: Sinking of pre-connectorised cables without problems, for additional installation  
 Properties: non-halogen  
 Protection class: IP 54  
 Temperature range: -40°C / +105°C



FLEXAzip® Schmales Profil Schwarz				FLEXAzip® Narrow profile Black		
AD mm	Øl mm	R±10% stat mm	R±10% dyn mm	Art.-Nr.   Art. No.		
13.0	10.0	20	60	0255.202.110	1	
15.8	12.0	25	80	0255.202.112	1	
21.2	16.5	40	120	0255.202.116	1	
28.5	23.0	45	170	0255.202.123	1	
34.5	29.0	55	170	0255.202.129	1	
42.5	36.0	65	200	0255.202.136	1	
54.5	48.5	80	240	0255.202.148	1	

### AGROflip B selbstschliessender Geflechschlauch | AGROflip B self-closing braided sleeving

Material: Polyester PET  
 Monofil: Ø 0.25mm  
 Einsatzbereich: Problemloses Einziehen von vorkonfektionierten Kabeln, für nachträgliche Installation  
 Eigenschaften: Hochflexibel, selbstanpassend, abriebfest, frei von Cadmium, Formaldehyd, Halogen und Graphit, selbstverlöschend nach DIN 75200 (FMVSS 302), gute Beständigkeit gegen Kraftstoffe, Mineralöle und viele weitere Chemikalien  
 Einsatztemperatur: -50°C / +150°C

Material: Polyester PET  
 Monofil: Ø 0.25mm  
 Application: Sinking of pre-connectorised cables without problems, for additional installation  
 Properties: Highly flexible, self-adapting, resistant to abrasion, free of cadmium, formaldehyde, halogen and graphite, self-extinguishing acc. to DIN 75200 (FMVSS 302), good resistance to fuel, mineral oil and many other chemicals  
 Temperature range: -50°C / +150°C



AGROflip B Schwarz		AGROflip B Black		
NW	ømax mm	Art.-Nr.   Art. No.		
6	6	6878.40.06	25	
9	9	6878.40.09	25	
13	13	6878.40.13	25	
19	19	6878.40.19	20	
25	25	6878.40.25	20	
32	32	6878.40.32	20	
38	38	6878.40.38	20	
50	50	6878.40.50	20	

Nominaler Innendurchmesser mit einer Überlappung von 25% / 90°

Nominal inner diameter with 25% / 90° overlap

# ROHRflex®-Duo Kunststoff Schutzschlauch zweiteilig

## ROHRflex®-Duo synthetic protective conduit two-piece

Schmales Profil | Fine profile

Material:	Polyamid PA 6	Material:	Polyamide PA 6
Brandklasse:	HB (UL 94)	Fire classification:	HB (UL 94)
Eigenschaften:	Zweiteiliges Kabelschutzrohr, weitgehend chemikalienbeständig, halogen-, phosphor- und cadmiumfrei, selbstverlöschend, flammwidrig, flexibel, biegegeschwellebeständig, UV-beständig	Properties:	two-piece protective cable conduit, basically resistant to chemicals, free of halogen, phosphorus and cadmium, self-extinguishing, flame retardant, flexible, bending resistant, UV resistant
Einsatzbereich:	Maschinen- und Anlagenbau, Fahrzeugbau, Schiffsbau, Automation, Elektroanlagen	Application:	Machine and plant constructions, automotive, shipbuilding, automation, electrical installations
Einsatztemperatur:	-40°C / +120°C	Temperature range:	-40°C / +120°C

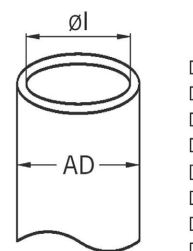

Wellrohr zweiteilig Schwarz					Two-piece corrugated conduit Black	
AD mm	Ø mm	øl mm	R±10% stat mm	R±10% dyn mm	Art.-Nr.   Art. No.	
10.0	10.3	5.6	30	90	0269.202.006	50
13.0	13.3	8.5	35	110	0269.202.008	50
15.8	16.0	11.0	40	120	0269.202.010	50
21.2	21.5	15.5	55	170	0269.202.014	50
25.0	25.6	19.1	75	230	0269.202.019	50
28.5	28.5	21.9	95	290	0269.202.020	50
32.0	31.7	24.0	110	330	0269.202.024	25
34.5	35.0	27.2	120	360	0269.202.026	25
42.5	42.5	32.0	135	410	0269.202.032	25
54.5	53.9	43.9	140	420	0269.202.043	25
79.0	79.0	62.2	200	600	0269.202.061	10



# Teilbare Kunststoffverschraubung zu ROHRflex®-Duo

## Separable synthetic connector for ROHRflex®-Duo

### Teilbare Kunststoffverschraubung zu ROHRflex®-Duo | Separable synthetic connector for ROHRflex®-Duo

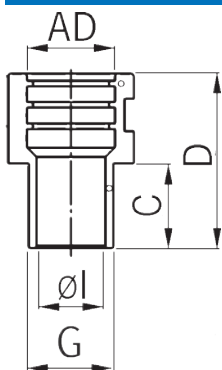



Material: Polyamid PA 6  
 Brandklasse: V0 (UL 94)  
 Eigenschaften: Axial aufklappbar und wieder verschliessbare Anschlussverschraubung mit angeformten Haltestegen für zweiteilige Kabelschutzrohre, Sicherheitsrastung gegen unbeabsichtigtes Öffnen  
 Einsatzbereich: Maschinen- und Anlagenbau, Fahrzeugbau, Schiffsbau, Automation, Elektroanlagen  
 Einsatztemperatur: -40°C / +120°C

Material: Polyamide PA 6  
 Fire classification: V0 (UL 94)  
 Properties: Axial swivelling and re-lockable connection with formed holding straps for two-piece corrugated tube, is equipped with safety shut-off stop against unintentional opening  
 Application: Machine and plant constructions, automotive, shipbuilding, automation, electrical installations  
 Temperature range: -40°C / +120°C



Teilbare Verschraubung zur ROHRflex®-Duo Kunststoff-Schutzschlauch  
 Schwarz

AD mm	G	ØI mm	C mm	D mm	 mm	Art.-Nr.   Art. No.	
15.8	M16x1.5	11	15	30	26	5128.015.216	10
15.8	M20x1.5	15	15	30	26	5128.015.220	10
21.2	M20x1.5	15	15	30	28	5128.021.220	10
21.2	M25x1.5	21	15	30	28	5128.021.225	10
28.5	M25x1.5	21	15	35	36	5128.028.225	10
28.5	M32x1.5	27	15	35	36	5128.028.232	5
34.5	M32x1.5	27	15	35	46	5128.034.232	5
34.5	M40x1.5	35	15	35	46	5128.034.240	5
42.5	M40x1.5	35	15	35	55	5128.042.240	5
42.5	M50x1.5	44	20	40	55	5128.042.250	5
54.5	M50x1.5	44	20	45	65	5128.054.250	5
54.5	M63x1.5	57	20	45	65	5128.054.263	5

### Teilbare Kunststoff-Gegenmutter zu ROHRflex®-Duo | Separable locking plug for ROHRflex®-Duo

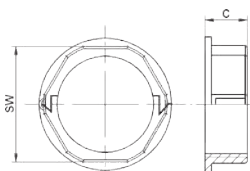

Material: Polyamid PA 6  
 Brandklasse: V0 (UL 94)  
 Eigenschaften: Axial aufklappbar und wieder verschliessbare Gegenmutter, Sicherheitsrastung gegen unbeabsichtigtes Öffnen  
 Einsatzbereich: Maschinen- und Anlagenbau, Fahrzeugbau, Schiffsbau, Automation, Elektroanlagen  
 Einsatztemperatur: -40°C / +120°C

Material: Polyamide PA 6  
 Fire classification: V0 (UL 94)  
 Properties: Axial swivelling and re-lockable locknut with safety shut-off stop against unintentional opening  
 Application: Machine and plant constructions, automotive, shipbuilding, automation, electrical installations  
 Temperature range: -40°C / +120°C



Teilbare Gegenmutter zu ROHRflex®-Duo  
 Kabelschutzschlauch  
 Schwarz

Separable lock nut for ROHRflex®-Duo cable protective conduit  
 Black

G	C mm	 mm	Art.-Nr.   Art. No.	
M16x1.5	10	26	0318.000.016	10
M20x1.5	10	26	0318.000.020	10
M25x1.5	10	28	0318.000.025	10
M32x1.5	10	36	0318.000.032	5
M40x1.5	12	46	0318.000.040	5
M50x1.5	12	56	0318.000.050	5
M63x1.5	12	71	0318.000.063	5



### Schlauchhalter zu Kunststoff Schutzschlauch | Conduit clamp for synthetic protective conduit

Material:	Polyamid	Material:	Polyamide
Brandklasse:	V0 (UL 94)	Fire classification:	V0 (UL 94)
Eigenschaften:	Zugentlastung durch Rippenfixierung	Properties:	With fixing ribs as strain relief
Einsatzbereich:	Zentrumsbefestigung mit Schraube oder einsetzbar in C-Profil-schiene	Application:	Fastening with central screw or by insertion into a C-profile bar
Einsatztemperatur:	-40°C / +120°C	Temperature range:	-40°C / +120°C

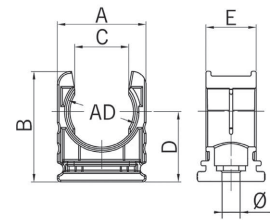

Schlauchhalter RQH Schwarz							Conduit clamp RQH Black	
AD mm	A mm	B mm	C mm	D mm	E mm	Ø mm	Art.-Nr.   Art. No.	
10.0	19.5	19.0	8.4	13.0	15.0	4.5	5030.025.207	50
13.0	19.5	22.6	9.3	14.5	15.0	4.5	5030.025.209	50
15.8	21.5	25.4	11.2	16.1	15.0	5.5	5030.025.211	50
18.5	24.5	33.0	12.6	18.0	15.0	5.5	5030.025.213	50
21.2	26.5	33.0	16.6	21.0	15.0	5.5	5030.025.216	50
28.5	34.7	39.4	20.4	22.7	15.0	5.5	5030.025.221	25
34.5	40.0	44.4	25.6	26.0	15.0	6.5	5030.025.229	25
42.5	54.5	55.5	30.1	32.0	20.0	6.5	5030.025.236	25
54.5	65.5	68.8	38.1	39.0	20.0	6.5	5030.025.248	10



### Deckel zu Schlauchhalter RQH | Cover for conduit clamp RQH

Material:	Polyamid	Material:	Polyamide
Brandklasse:	V0 (UL 94)	Fire classification:	V0 (UL 94)
Einsatztemperatur:	-40°C / +120°C	Temperature range:	-40°C / +120°C

Schwarz		Black	
AD mm	Art.-Nr.   Art. No.	Art.-Nr.   Art. No.	
10.0	5030.026.207	5030.026.207	50
13.0	5030.026.209	5030.026.209	50
15.8	5030.026.211	5030.026.211	50
18.5	5030.026.213	5030.026.213	50
21.2	5030.026.216	5030.026.216	50
28.5	5030.026.221	5030.026.221	25
34.5	5030.026.229	5030.026.229	25
42.5	5030.026.236	5030.026.236	25
54.5	5030.026.248	5030.026.248	10



# Kunststoff Schlauchverschraubungen

## Synthetic conduit connectors



**Kunststoff Schlauchverschraubungen** sind erhältlich für Einsatzgebiete von  $-40^{\circ}\text{C}$  bis  $+120^{\circ}\text{C}$ , für Schutzarten bis IP 69K, sind lösemittelresistent, luft- und flüssigkeitsdicht, in schwarz UV-beständig.

Die Kunststoff Schlauchverschraubungen haben einen „push-in“ Verschluss. Dadurch kann der Kabelschutzschlauch schnell und ausreissfest montiert werden.

Durch den integrierten Dichteinsatz wird ohne zusätzliche Massnahmen immer ein hoher IP-Schutzgrad erreicht. Die Kunststoff Schlauchverschraubungen erfüllen weltweite Zulassungen.

### Wichtigste Eigenschaften

- Aus schlagfestem Polyamid
- Luft- und flüssigkeitsdicht
- Öl- und benzinbeständig
- Gute Laugen- und Säurenbeständigkeit
- Halogenfrei
- In schwarz UV beständig

### Brandschutz Zertifikate für Schienenfahrzeuge

- EN 45545-2

Bezüglich Zertifikate und Zulassungen von Schlauchverschraubungen, wenden Sie sich bitte direkt an Ihren Ansprechpartner im Vertrieb.

### Normen

Für schutzisolierte Elektroinstallationen, geeignet für Montagen nach Anwendungsvorschriften EN / IEC 60204 im Maschinen- und Anlagenbau.

Besondere Anforderungen nach EN / IEC 61386-23 für flexible Installationsrohrsysteme zum Führen von Leitungen für elektrische Energie und für Informationen.

**Synthetic conduit connectors** are available for applications from  $-40^{\circ}\text{C}$  to  $+120^{\circ}\text{C}$ , for Protection Classes up to IP 69K, are resistant to solvents, sealed against air and fluids, and in black are UV resistant.

The synthetic conduit connectors have a push-in lock. With it, cable conduits can be assembled quickly with high pull-out resistance.

Through the integrated sealing insert, a higher IP protection class is always achieved without any additional measures. The synthetic conduit connectors meet requirements for worldwide type approvals.

### Key properties

- Made of impact-resistant polyamide
- Sealed against air and liquids
- Resistant to oil and petrol
- High resistance to acids and alkaline substances
- Halogen-free
- In black, UV-resistant

### Fire-protection certificates for railway vehicles

- EN 45545-2

For certificates and approvals for synthetic conduit connectors, please contact your sales contact directly.

### Standards

For totally insulated electrical installations, suitable for assembly according to application regulations EN / IEC 60204 in machine and system construction.

Special requirements according to EN / IEC 61386-23 for flexible conduit systems when running lines for electrical power and data.



<p>Kunststoff Schlauchverschraubungen gerade          Synthetic straight conduit connectors</p>		<p>36 - 41</p>	<p>1</p>
<p>Kunststoff Schlauchverschraubungen gerade mit Innengewinde          Synthetic straight conduit connectors with inner thread</p>		<p>42 - 43</p>	<p>2</p>
<p>Kunststoff Schlauchverschraubungen gerade mit integrierter Zugentlastung          Synthetic straight conduit connectors with integrated strain-relief</p>		<p>44 - 45</p>	<p>3</p>
<p>Kunststoff Schlauchverschraubungen gerade mit Steckanschluss          Synthetic straight conduit connectors with plug-in connection</p>		<p>46</p>	<p>4</p>
<p>Kunststoff Schlauchverschraubungen gerade für Verbindung auf Installationsrohre          Synthetic straight conduit connectors for connection to solid tubes</p>		<p>47</p>	<p>5</p>
<p>Kunststoff Schlauchverschraubungen Winkel 90°          Synthetic conduit connectors elbow 90°</p>		<p>48 - 52</p>	<p>6</p>
<p>Kunststoff Schlauchverschraubungen Bogen 90°          Synthetic conduit connectors 90° bend</p>		<p>53 - 56</p>	<p>7</p>
<p>Kunststoff Schlauchverschraubungen Bogen 45°          Synthetic conduit connectors 45° bend</p>		<p>57 - 59</p>	<p>8</p>
<p>Anschlussflansch für Kunststoff Schlauchverschraubungen          Connecting flange for synthetic conduit connectors</p>		<p>60 - 61</p>	<p>10</p>
<p>Kunststoff Schlauchverschraubungen Verteiler-Kupplungen          Synthetic conduit connectors distributor coupling</p>		<p>62 - 64</p>	<p>11</p>
<p>End- und Übergangsstüben          End and transition bushing</p>		<p>65 - 66</p>	<p>12</p>

# Kunststoff Schlauchverschraubungen

## Synthetic conduit connectors



**Kunststoff Schlauchverschraubungen aus schlagfestem Polyamid** sind in vielen Anwendungen im Maschinen- und Anlagenbau, Automation, Elektroanlagen, Fahrzeugbau und Schienenfahrzeugen anzutreffen.

Gute mechanische Eigenschaften, Flexibilität, Abriebs- und Ermüdungsbeständigkeit sowie eine hohe Widerstandsfähigkeit gegenüber Ölen und Chemikalien gehören zu den Grundanforderungen die der Kunststoff Polyamid erfüllt.

Für den Einsatz in der Bahnindustrie werden die wichtigsten Brandschutznormen für Schienenfahrzeuge erfüllt.

**Synthetic conduit connectors made of impact-resistant polyamide** can be found in many applications in machine and system construction, automation, electrical systems, vehicle construction and railway vehicles.

Good mechanical properties, flexibility, resistance to wear and fatigue along with high resistance to oils and chemicals are among the basic requirements which the polyamide synthetic fulfils.

For use in the railway industry, the most important fire-protection standards are met.



Für die verschiedenen Kunststoff Schutzschläuche und ihre vielfältigen Anwendungen werden auch unterschiedliche Kunststoff Schlauchverschraubungen benötigt.

Bei AGRO finden Sie sowohl alle gängigen Gewindeformen, je nach Anwendungsfall auch mit Messing Anschlussgewinde, aber auch individuelle Lösungen.

Die Kunststoff Schlauchverschraubungen sind speziell auf unsere Kabelschutzschläuche zugeschnitten, nur so können wir eine optimale Passfähigkeit und Dichtigkeit sicherstellen.

Various synthetic conduit connectors are also required for the different types of synthetic protective conduit and their wide range of applications.

At AGRO you will find all common thread types, and depending on the application also with brass entry threads, as well as customised solutions.

The synthetic conduit connectors are tailored specially to our cable protective conduits because only in this way can we ensure optimal fitting and sealing.

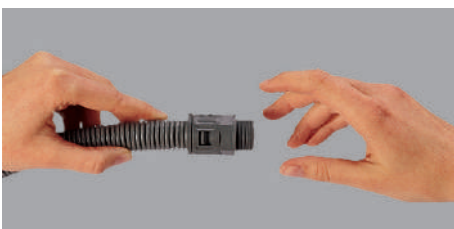

**Schnelles Montagesystem ohne Werkzeuge**, die Kunststoff Schlauchverschraubung wird einfach auf den Kabelschutzschlauch geschoben und fertig ist die dichte, ausreissfeste Verbindung.

Der entlastete Wellschlauch drückt die Krallen der Rasthülse in die Wellschlauchtäler. Hierdurch wird die Verschraubung einwandfrei verriegelt.

Die werkzeuglose **Demontage** des Wellschlauches erfolgt durch Andrücken des Bundes der Rasthülse an den Verschraubungskörper, danach kann der Schutzschlauch problemlos herausgezogen werden.



**Quick assembly system without tools.** A synthetic conduit connector is simply pushed onto the cable protective conduit and the sealed, pull-out proof connection is complete.

The strain-relieved corrugated conduit pushes the claws of the snap-in sleeve between the ribs, which means a perfect seal in the connector

Disassembly of the corrugated conduit without tools is done by pressing the ring on the snap-in sleeve towards the cable gland body, after which the protective conduit can be easily pulled out.



### Konstruktion

Verschraubungsgehäuse mit oder ohne Sechskantschlüsselfläche, integrierte Rasthülse mit Dichteinsatz (IP 68 / IP 69K), ohne Dichteinsatz (>IP 65)

### Material

#### Kunststoffverschraubungen

Kunststoff (PA)  
Dichtung TPE

#### Kunststoffverschraubungen mit Messinggewinde

Kunststoff (PA)  
**Gewinde** MS 58 vernickelt  
**Dichtung** TPE

### Eigenschaft

- Rationelle Schlauchmontage durch einteilige Verschraubung mit „push-in“-Verschluss
- Einfache Demontage durch Verschieben der Rasthülse
- Kleinstmögliche Aussenmasse für minimalsten Verschraubungsabstand

### Demontagesicherung:

Einfach zwischen Rasthülse und Verschraubungskörper einen O-Ring aufschieben. Dadurch kann die Verschraubung nicht mehr ohne Werkzeug demontiert werden.

### Verwendung

Zur fachgerechten Montage als schutzisolierte Verschraubung geeignet nach Anwendungsvorschriften EN / IEC 60204 im Maschinen- und Anlagenbau.

### Design

Connector casing with or without hexagon wrench surface, integrated snap-in sleeve with sealing insert (IP 68 / IP 69K), without sealing insert (> IP 65)

### Material

#### Synthetic connectors

Synthetic (PA)  
Seal TPE

#### Synthetic connectors with brass threads

Synthetic (PA)  
**Threads** MS 58 nickel-plated  
**Seal** TPE

### Features

- Efficient conduit assembly thanks to 1-piece conduit connector with push-in lock
- Simple disassembly by pushing on the snap-in sleeve
- Smallest possible outside dimensions for minimal conduit connector separation

### Disassembly safety feature:

Simply push on an O-ring between the snap-in sleeve and the connector body. Because of this, the connector can no longer be removed without tools.

### Application

Suited for professional installation as a totally insulated connector in machine and plant construction according to regulations EN / IEC 60204.

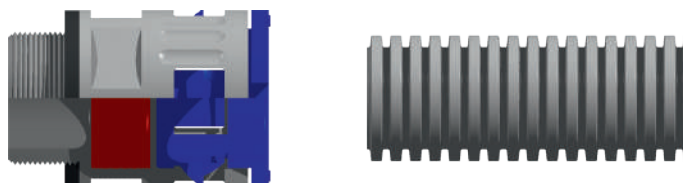

- 1 Flachdichtung für IP-Schutzart
- 2 Grundkörper
- 3 Dichteinsatz integriert
- 4 Rasthülse

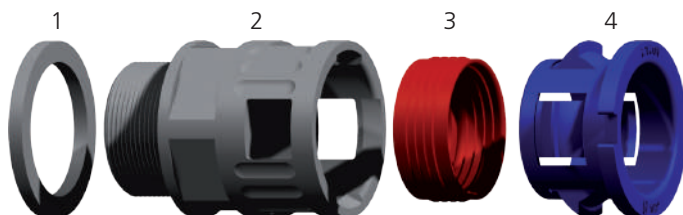

1. Flat gasket for IP protection classes
2. Base body
3. Integrated sealing insert
4. Snap-in sleeve

# Kunststoff Schlauchverschraubung gerade

## Synthetic straight conduit connector

### Anschlussgewinde metrisch | Entry thread metric

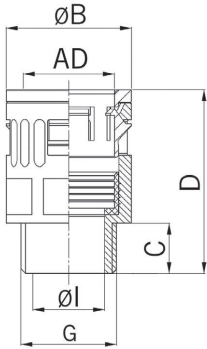

Material: Polyamid schlagfest  
 Dichtung: TPE  
 Brandklasse: V0 (UL 94)  
 Eigenschaften: Schnelle und ausreissfeste Montage durch «push-in»-Verschluss, einfache Demontage durch Andrücken der Rasthülse  
 Schutzart: IP 68 / IP 69  
 Einsatztemperatur: -40°C / +120°C

Material: Polyamide impact-resistant  
 Seal: TPE  
 Fire classification: V0 (UL 94)  
 Properties: Quick and pull-out-proof installation by means of the «push-in» lock, simple dismounting by displacing the snap-in sleeve  
 Protection class: IP 68 / IP 69  
 Temperature range: -40°C / +120°C



Quick-Verschraubung RQG-M  
Schwarz

Quick connector RQG-M  
Black

AD mm	G	ØI mm	ØB mm	C mm	D mm	Øl mm	Art.-Nr.   Art. No.	
10.0	M10x1.0	6.0	17.0	11.5	34.5	16	5020.037.210	50
10.0	M12x1.5	7.0	17.0	11.5	34.5	16	5020.065.203	50
13.0	M12x1.5	7.0	20.0	12.0	37.0	18	5020.037.212	50
13.0	M16x1.5	10.0	20.0	11.5	37.0	18	5020.065.205	50
15.8	M16x1.5	11.0	23.0	11.5	39.0	21	5020.037.216	50
15.8	M20x1.5	12.0	25.0	13.0	39.0	21	5020.065.207	50
21.2	M20x1.5	16.0	29.5	13.0	44.5	27	5020.037.220	50
21.2	M25x1.5	17.0	29.5	13.0	44.5	27	5020.065.209	50
28.5	M25x1.5	20.5	37.0	13.0	47.0	34	5020.037.225	25
28.5	M32x1.5	23.5	37.0	15.0	49.0	34	5020.065.211	25
34.5	M32x1.5	25.5	44.0	15.0	51.0	40	5020.037.232	25
34.5	M40x1.5	30.5	48.5	15.0	51.5	40	5020.037.238	25
42.5	M40x1.5	32.0	58.0	17.0	76.0	55	5020.037.240	25
42.5	M50x1.5	37.5	63.0	17.0	76.0	60	5020.037.245	25
54.5	M50x1.5	39.0	68.0	17.0	88.0	65	5020.037.250	10
54.5	M63x1.5	49.0	74.0	17.0	88.0	70	5020.037.263	10

Auf Anfrage lieferbar:

Available on request:

Ausführungen mit CTG oder NPT Anschlussgewinde

Executions with CTG or NPT entry thread



Quick-Verschraubung RQG-M  
Grau

Quick connector RQG-M  
Grey

AD mm	G	ØI mm	ØB mm	C mm	D mm	Øl mm	Art.-Nr.   Art. No.	
10.0	M10x1.0	6.0	17.0	11.5	34.5	16	5020.037.010	50
10.0	M12x1.5	7.0	17.0	11.5	34.5	16	5020.065.003	50
13.0	M12x1.5	7.0	20.0	12.0	37.0	18	5020.037.012	50
13.0	M16x1.5	10.0	20.0	11.5	37.0	18	5020.065.005	50
15.8	M16x1.5	11.0	23.0	11.5	39.0	21	5020.037.016	50
15.8	M20x1.5	12.0	25.0	13.0	39.0	21	5020.065.007	50
21.2	M20x1.5	16.0	29.5	13.0	44.5	27	5020.037.020	50
21.2	M25x1.5	17.0	29.5	13.0	44.5	27	5020.065.009	50
28.5	M25x1.5	20.5	37.0	13.0	47.0	34	5020.037.025	25
28.5	M32x1.5	23.5	37.0	15.0	49.0	34	5020.065.011	25
34.5	M32x1.5	25.5	44.0	15.0	51.0	40	5020.037.032	25
34.5	M40x1.5	30.5	48.5	15.0	51.5	40	5020.037.038	25
42.5	M40x1.5	32.0	58.0	17.0	76.0	55	5020.037.040	25
42.5	M50x1.5	37.5	63.0	17.0	76.0	60	5020.037.045	25
54.5	M50x1.5	39.0	68.0	17.0	88.0	65	5020.037.050	10
54.5	M63x1.5	49.0	74.0	17.0	88.0	70	5020.037.063	10



# Kunststoff Schlauchverschraubung gerade

## Synthetic straight conduit connector

Anschlussgewinde Pg | Entry thread Pg

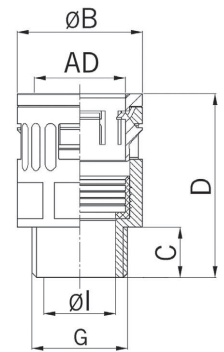

Material: Polyamid schlagfest  
 Dichtung: TPE  
 Brandklasse: V0 (UL 94)  
 Eigenschaften: Schnelle und ausreissfeste Montage durch «push-in»-Verschluss, einfache Demontage durch Andrücken der Rasthülse  
 Schutzart: IP 68 / IP 69  
 Einsatztemperatur: -40°C / +120°C

Material: Polyamide impact-resistant  
 Seal: TPE  
 Fire classification: V0 (UL 94)  
 Properties: Quick and pull-out-proof installation by means of the «push-in» lock, simple dismounting by displacing the snap-in sleeve  
 Protection class: IP 68 / IP 69  
 Temperature range: -40°C / +120°C



Quick-Verschraubung RQG-P  
 Schwarz

Quick connector RQG-P  
 Black

AD mm	G	ØI mm	ØB mm	C mm	D mm		Art.-Nr.   Art. No.	
10.0	Pg 7	7.0	17.0	10.0	32.5	16	5020.026.207	50
13.0	Pg 9	10.0	20.0	10.0	35.0	18	5020.026.209	50
15.8	Pg 11	12.5	23.0	10.0	37.0	21	5020.026.211	50
18.5	Pg 13	13.5	26.0	13.0	43.0	24	5020.026.213	50
18.5	Pg 16	17.0	25.5	11.0	42.0	21	5020.026.214	25
21.2	Pg 16	17.0	29.5	13.0	46.0	27	5020.026.216	50
28.5	Pg 21	23.5	37.0	12.5	48.5	34	5020.026.221	25
34.5	Pg 29	30.0	44.0	14.5	53.5	40	5020.026.229	25
42.5	Pg 36	36.0	63.0	17.0	76.0	60	5020.026.236	25
54.5	Pg 48	47.5	74.0	17.0	88.0	70	5020.026.248	10

Auf Anfrage lieferbar:

Available on request:



Ausführungen mit CTG oder NPT Anschlussgewinde

Executions with CTG or NPT entry thread



Quick-Verschraubung RQG-P  
 Grau

Quick connector RQG-P  
 Grey

AD mm	G	ØI mm	ØB mm	C mm	D mm		Art.-Nr.   Art. No.	
10.0	Pg 7	7.0	17.0	10.0	32.5	16	5020.026.007	50
13.0	Pg 9	10.0	20.0	10.0	35.0	18	5020.026.009	50
15.8	Pg 11	12.5	23.0	10.0	37.0	21	5020.026.011	50
18.5	Pg 13	13.5	26.0	13.0	43.0	24	5020.026.013	50
18.5	Pg 16	17.0	25.5	11.0	42.0	21	5020.026.014	25
21.2	Pg 16	17.0	29.5	13.0	46.0	27	5020.026.016	50
28.5	Pg 21	23.5	37.0	12.5	48.5	34	5020.026.021	25
34.5	Pg 29	30.0	44.0	14.5	53.5	40	5020.026.029	25
42.5	Pg 36	36.0	63.0	17.0	76.0	60	5020.026.036	25
54.5	Pg 48	47.5	74.0	17.0	88.0	70	5020.026.048	10



# Kunststoff Schlauchverschraubung gerade

## Synthetic straight conduit connector

### Anschlussgewinde Pg | Entry thread Pg

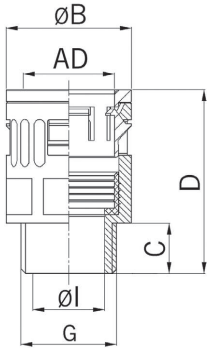

Material: Polyamid schlagfest  
 Dichtung: TPE  
 Brandklasse: V0 (UL 94)  
 Eigenschaften: Schnelle und ausreissfeste Montage durch «push-in»-Verschluss, einfache Demontage durch Andrücken der Rasthülse  
 Einsatzbereich: Direkte Reduzierung / Erweiterung  
 Schutzart: IP 68 / IP 69  
 Einsatztemperatur: -40°C / +120°C

Material: Polyamide impact-resistant  
 Seal: TPE  
 Fire classification: V0 (UL 94)  
 Properties: Quick and pull-out-proof installation by means of the «push-in» lock, simple dismounting by displacing the snap-in sleeve  
 Application: Direct reduction / enlarging fitting  
 Protection class: IP 68 / IP 69  
 Temperature range: -40°C / +120°C



Quick-Verschraubung RQG-P  
Schwarz

Quick connector RQG-P  
Black

AD mm	G	ØI mm	ØB mm	C mm	D mm	Ø mm	Art.-Nr.   Art. No.	
13.0	Pg 7	8.0	20.0	10	35.0	18	5020.027.201E	50
10.0	Pg 9	7.0	18.5	10	32.5	16	5020.027.202R	50
10.0	Pg 11	7.0	21.0	10	32.5	16	5020.027.203R	50
13.0	Pg 11	10.0	21.0	10	35.0	18	5020.027.204R	50
10.0	Pg 13	7.0	23.0	10	32.5	16	5020.027.205R	25
13.0	Pg 13	10.0	23.0	10	35.0	18	5020.027.206R	25
15.8	Pg 13	12.5	23.0	10	37.0	21	5020.027.207R	50
21.2	Pg 13	15.4	29.5	13	43.5	27	5020.027.209E	10
15.8	Pg 16	12.5	26.5	10	37.0	21	5020.027.210E	25
28.5	Pg 16	17.0	37.0	12	48.5	34	5020.027.208E	10

Auf Anfrage lieferbar:

Available on request:

Ausführungen mit CTG oder NPT Anschlussgewinde

Executions with CTG or NPT entry thread



Quick-Verschraubung RQG-P  
Grau

Quick connector RQG-P  
Grey

AD mm	G	ØI mm	ØB mm	C mm	D mm	Ø mm	Art.-Nr.   Art. No.	
13.0	Pg 7	8.0	20.0	10	35.0	18	5020.027.001E	50
10.0	Pg 9	7.0	18.5	10	32.5	16	5020.027.002R	50
10.0	Pg 11	7.0	21.0	10	32.5	16	5020.027.003R	50
13.0	Pg 11	10.0	21.0	10	35.0	18	5020.027.004R	50
10.0	Pg 13	7.0	23.0	10	32.5	16	5020.027.005R	25
13.0	Pg 13	10.0	23.0	10	35.0	18	5020.027.006R	25
15.8	Pg 13	12.5	23.0	10	37.0	21	5020.027.007R	25
21.2	Pg 13	15.4	29.5	13	43.5	27	5020.027.009E	10
15.8	Pg 16	12.5	26.5	10	37.0	21	5020.027.010E	25
28.5	Pg 16	17.0	37.0	12	48.5	34	5020.027.008E	10





# Kunststoff Schlauchverschraubung gerade, konisch dichtend

## Synthetic straight conduit connector, conically sealing

Anschlussgewinde metrisch | Entry thread metric

Material: Polyamid schlagfest  
 Dichtung: Schlauchanschluss konisch dichtend  
 Brandklasse: V0 (UL 94)  
 Eigenschaften: Schnelle und ausreissfeste Montage durch «push-in»-Verschluss, einfache Demontage durch Andrücken der Rasthülse  
 Schutzart: IP 66  
 Einsatztemperatur: -40°C / +120°C

Material: Polyamide impact-resistant  
 Seal: Conically sealing connection  
 Fire classification: V0 (UL 94)  
 Properties: Quick and pull-out-proof installation by means of the «push-in» lock, simple dismantling by displacing the snap-in sleeve  
 Protection class: IP 66  
 Temperature range: -40°C / +120°C

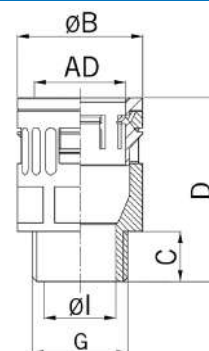

Quick-Verschraubung RQG1-M Schwarz							Quick connector RQG1-M Black	
AD mm	G	ØI mm	ØB mm	C mm	D mm	 mm	Art.-Nr.   Art. No.	
10.0	M12x1.5	7.0	17.0	11.5	34.5	16	5020.055.211	50
13.0	M12x1.5	7.0	20.0	12.0	37.0	18	5020.055.212	50
13.0	M16x1.5	10.0	20.0	11.5	37.0	18	5020.055.214	50
15.8	M16x1.5	11.0	23.0	11.5	39.0	21	5020.055.216	50
15.8	M20x1.5	12.0	25.0	13.0	39.0	21	5020.055.218	50
21.2	M20x1.5	16.0	29.5	13.0	44.5	27	5020.055.220	50
21.2	M25x1.5	17.0	29.5	13.0	44.5	27	5020.055.222	50
28.5	M25x1.5	20.5	37.0	13.0	47.0	34	5020.055.225	25
28.5	M32x1.5	23.5	37.0	15.0	49.0	34	5020.055.228	25
34.5	M32x1.5	25.5	44.0	15.0	51.0	40	5020.055.232	25
34.5	M40x1.5	30.5	48.5	15.0	51.5	40	5020.055.236	25
42.5	M40x1.5	32.0	52.0	15.0	53.5	48	5020.055.240	25
42.5	M50x1.5	36.5	56.0	15.5	55.0	48	5020.055.245	10
54.5	M50x1.5	42.5	63.5	15.5	55.0	59	5020.055.250	10
54.5	M63x1.5	48.0	66.0	16.0	55.0	59	5020.055.263	10

Auf Anfrage lieferbar:

Available on request:

Ausführungen mit CTG oder NPT Anschlussgewinde

Executions with CTG or NPT entry thread



Quick-Verschraubung RQG1-M Grau							Quick connector RQG1-M Grey	
AD mm	G	ØI mm	ØB mm	C mm	ØD mm	 mm	Art.-Nr.   Art. No.	
10.0	M12x1.5	7.0	17.0	11.5	34.5	16	5020.055.011	50
13.0	M12x1.5	7.0	20.0	12.0	37.0	18	5020.055.012	50
13.0	M16x1.5	10.0	20.0	11.5	37.0	18	5020.055.014	50
15.8	M16x1.5	11.0	23.0	11.5	39.0	21	5020.055.016	50
15.8	M20x1.5	12.0	25.0	13.0	39.0	21	5020.055.018	50
21.2	M20x1.5	16.0	29.5	13.0	44.5	27	5020.055.020	50
21.2	M25x1.5	17.0	29.5	13.0	44.5	27	5020.055.022	50
28.5	M25x1.5	20.5	37.0	13.0	47.0	34	5020.055.025	25
28.5	M32x1.5	23.5	37.0	15.0	49.0	34	5020.055.028	25
34.5	M32x1.5	25.5	44.0	15.0	51.0	40	5020.055.032	25
34.5	M40x1.5	30.5	48.5	15.0	51.5	40	5020.055.036	25
42.5	M40x1.5	32.0	52.0	15.0	53.5	48	5020.055.040	25
42.5	M50x1.5	36.5	56.0	15.5	55.0	48	5020.055.045	25
54.5	M50x1.5	42.5	63.5	15.5	55.0	59	5020.055.050	10
54.5	M63x1.5	48.0	66.0	16.0	55.0	59	5020.055.063	10



# Kunststoff Schlauchverschraubung gerade konisch dichtend

## Synthetic straight conduit connector conically sealing

### Anschlussgewinde Pg | Entry thread Pg

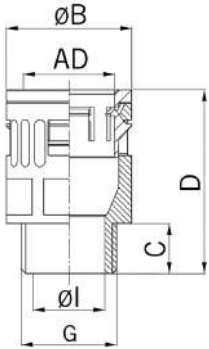

Material: Polyamid schlagfest  
 Dichtung: Schlauchanschluss konisch dichtend  
 Brandklasse: V0 (UL 94)  
 Eigenschaften: Schnelle und ausreissfeste Montage durch «push-in»-Verschluss, einfache Demontage durch Andrücken der Rasthülse  
 Schutzart: IP 66  
 Einsatztemperatur: -40°C / +120°C

Material: Polyamide impact-resistant  
 Seal: Conically sealing connection  
 Fire classification: V0 (UL 94)  
 Properties: Quick and pull-out-proof installation by means of the «push-in» lock, simple dismounting by displacing the snap-in sleeve  
 Protection class: IP 66  
 Temperature range: -40°C / +120°C



Quick-Verschraubung RQG1-P  
Schwarz

Quick connector RQG1-P  
Black

AD mm	G	ØI mm	ØB mm	C mm	D mm	mm	Art.-Nr.   Art. No.	
10.0	Pg 7	7.0	17.0	10.0	32.5	16	5020.049.207	50
13.0	Pg 9	10.0	20.0	10.0	35.0	18	5020.049.209	50
15.8	Pg 11	12.5	23.0	10.0	37.0	21	5020.049.211	50
18.5	Pg 13	13.5	26.0	13.0	43.0	24	5020.049.213	50
21.2	Pg 16	17.0	29.5	13.0	46.0	27	5020.049.216	50
28.5	Pg 21	23.5	37.0	12.5	48.5	34	5020.049.221	25
34.5	Pg 29	30.0	44.0	14.5	53.5	40	5020.049.229	25
42.5	Pg 36	36.5	51.5	14.5	56.0	48	5020.049.236	25
54.5	Pg 48	48.0	65.5	15.5	58.0	59	5020.049.248	10



Quick-Verschraubung RQG1-P  
Grau

Quick connector RQG1-P  
Grey

AD mm	G	ØI mm	ØB mm	C mm	D mm	mm	Art.-Nr.   Art. No.	
10.0	Pg 7	7.0	17.0	10.0	32.5	16	5020.049.007	50
13.0	Pg 9	10.0	20.0	10.0	35.0	18	5020.049.009	50
15.8	Pg 11	12.5	23.0	10.0	37.0	21	5020.049.011	50
18.5	Pg 13	13.5	26.0	13.0	43.0	24	5020.049.013	50
21.2	Pg 16	17.0	29.5	13.0	46.0	27	5020.049.016	50
28.5	Pg 21	23.5	37.0	12.5	48.5	34	5020.049.021	25
34.5	Pg 29	30.0	44.0	14.5	53.5	40	5020.049.029	25
42.5	Pg 36	36.5	51.5	14.5	56.0	48	5020.049.036	25
54.5	Pg 48	48.0	65.5	15.5	58.0	59	5020.049.048	10



# Kunststoff Schlauchverschraubung gerade mit Messing Anschlussgewinde

## Synthetic straight conduit connector with nickel-plated brass entry thread

### Anschlussgewinde metrisch | Entry thread metric

Material: Flexamid V0 (HL 3)  
 Gewinde: Messing vernickelt  
 Dichtung: TPE  
 Brandklasse: V0 (UL 94)  
 Eigenschaften: Schnelle und ausreissfeste Montage durch «push-in»-Verschluss, einfache Demontage durch Andrücken der Rasthülse  
 Schutzart: IP 68 / IP 69  
 Einsatztemperatur: -40°C / +120°C

Material: Flexamide V0 (HL 3)  
 Entry thread: Nickel-plated brass  
 Seal: TPE  
 Fire classification: V0 (UL 94)  
 Properties: Quick and pull-out-proof installation by means of the «push-in» lock, simple dismounting by displacing the snap-in sleeve  
 Protection class: IP 68 / IP 69  
 Temperature range: -40°C / +120°C

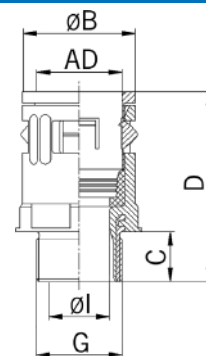

Quick-Verschraubung RQGK-M  
 Schwarz

Quick connector RQGK-M  
 Black

AD mm	G	ØI mm	ØB mm	C mm	D mm	 mm	Art.-Nr.   Art. No.	
10.0	M12x1.5	7.0	20.0	10.0	38.5	18	5107.010.212	50
13.0	M16x1.5	8.5	24.0	12.0	42.0	22	5107.013.216	50
15.8	M16x1.5	10.0	27.0	12.0	43.5	25	5107.015.216	50
15.8	M20x1.5	11.0	27.0	12.0	43.5	25	5107.015.220	50
21.2	M20x1.5	15.0	29.5	12.0	50.0	28	5107.021.220	25
21.2	M25x1.5	16.0	33.0	13.0	50.0	31	5107.021.225	25
28.5	M25x1.5	18.0	37.0	13.0	53.0	35	5107.028.225	25
28.5	M32x1.5	20.0	41.0	13.0	54.0	39	5107.028.232	25
34.5	M32x1.5	24.0	44.0	14.0	58.0	42	5107.034.232	25
34.5	M40x1.5	27.5	48.0	17.0	61.0	46	5107.034.240	25
42.5	M40x1.5	32.0	58.0	17.0	76.0	55	5107.042.240	10
42.5	M50x1.5	37.5	63.0	17.0	76.0	60	5107.042.250	10
54.5	M50x1.5	39.0	68.0	17.0	88.0	65	5107.054.250	10
54.5	M63x1.5	49.0	74.0	17.0	88.0	70	5107.054.263	10

Auf Anfrage lieferbar:

Available on request:

Ausführungen mit kurzem Anschlussgewinde

Executions with short entry thread



### Anschlussgewinde Pg | Entry thread Pg



Quick-Verschraubung RQGK-P  
 Schwarz

Quick connector RQGK-P  
 Black

AD mm	G	ØI mm	ØB mm	C mm	D mm	 mm	Art.-Nr.   Art. No.	
10.0	Pg 7	7.0	20.0	10.0	38.0	18	5020.074.207	50
13.0	Pg 9	8.5	24.0	12.0	42.0	22	5020.074.209	50
15.8	Pg 11	11.0	27.0	12.0	44.0	25	5020.074.211	50
21.2	Pg 16	16.0	33.0	13.0	51.0	31	5020.074.216	25
28.5	Pg 21	20.0	41.0	14.0	55.0	39	5020.074.221	25
34.5	Pg 29	27.5	48.0	14.0	59.0	46	5020.074.229	25
42.5	Pg 36	36.0	63.0	17.0	76.0	60	5020.074.236	10
54.5	Pg 48	47.5	74.0	17.0	88.0	70	5020.074.248	10



# Kunststoff Schlauchverschraubung gerade mit Innengewinde

## Synthetic straight conduit connector with inner thread

### Anschlussgewinde metrisch | Entry thread metric

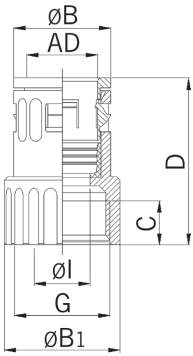

Material: Polyamid schlagfest  
 Brandklasse: V0 (UL 94)  
 Eigenschaften: Schnelle und ausreissfeste Montage durch «push-in»-Verschluss, einfache Demontage durch Andrücken der Rasthülse  
 Schutzart: IP 68 / IP 69  
 Einsatztemperatur: -40°C / +120°C

Material: Polyamide impact-resistant  
 Fire classification: V0 (UL 94)  
 Properties: Quick and pull-out-proof installation by means of the «push-in» lock, simple dismounting by displacing the snap-in sleeve  
 Protection class: IP 68 / IP 69  
 Temperature range: -40°C / +120°C



Quick-Verschraubung RQG2-M  
Schwarz

Quick connector RQG2-M  
Black

AD mm	G	ØI mm	ØB mm	ØB1 mm	C mm	D mm		Art.-Nr.   Art. No.	
13.0	M12x1.5	10.0	20.0	23.0	9.5	34.5	18	5020.078.215	50
13.0	M16x1.5	10.0	20.0	21.0	9.5	36.5	18	5020.078.214	50
15.8	M16x1.5	12.5	23.0	21.0	9.5	39.0	21	5020.078.216	50
21.2	M20x1.5	16.5	29.5	24.0	12.5	49.0	27	5020.078.220	50
28.5	M25x1.5	17.0	37.0	30.0	13.5	54.0	34	5020.078.225	25
34.5	M32x1.5	24.0	44.0	35.0	15.0	55.5	40	5020.078.232	10
42.5	M40x1.5	33.0	58.0	44.5	20.0	85.0	55	5020.078.240	25



Quick-Verschraubung RQG2-M  
Grau

Quick connector RQG2-M  
Grey

AD mm	G	ØI mm	ØB mm	ØB1 mm	C mm	D mm		Art.-Nr.   Art. No.	
13.0	M12x1.5	10.0	20.0	23.0	9.5	34.5	18	5020.078.015	50
13.0	M16x1.5	10.0	20.0	21.0	9.5	36.5	18	5020.078.014	50
15.8	M16x1.5	12.5	23.0	21.0	9.5	39.0	21	5020.078.016	50
21.2	M20x1.5	16.5	29.5	24.0	12.5	49.0	27	5020.078.020	50
28.5	M25x1.5	17.0	37.0	30.0	13.5	54.0	34	5020.078.025	25
34.5	M32x1.5	24.0	44.0	35.0	15.0	55.5	40	5020.078.032	25
42.5	M40x1.5	33.0	58.0	44.5	20.0	85.0	55	5020.078.040	25

### Anschlussgewinde metrisch | Entry thread metric

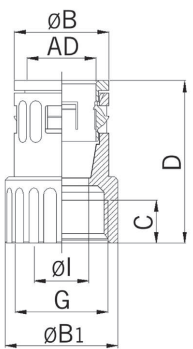

Material: Polyamid schlagfest  
 Dichtung: Schlauchanschluss konisch dichtend  
 Brandklasse: V0 (UL 94)  
 Eigenschaften: Schnelle und ausreissfeste Montage durch «push-in»-Verschluss, einfache Demontage durch Andrücken der Rasthülse  
 Schutzart: IP 66  
 Einsatztemperatur: -40°C / +120°C

Material: Polyamide impact-resistant  
 Seal: Conically sealing connection  
 Fire classification: V0 (UL 94)  
 Properties: Quick and pull-out-proof installation by means of the «push-in» lock, simple dismounting by displacing the snap-in sleeve  
 Protection class: IP 66  
 Temperature range: -40°C / +120°C



Quick-Verschraubung RQG3-M  
Schwarz

Quick connector RQG3-M  
Black

AD mm	G	ØI mm	ØB mm	ØB1 mm	C mm	D mm		Art.-Nr.   Art. No.	
13.0	M12x1.5	10.0	20.0	23.0	9.5	34.5	18	5020.079.215	50
13.0	M16x1.5	10.0	20.0	21.0	9.5	36.5	18	5020.079.214	50
15.8	M16x1.5	12.5	23.0	21.0	9.5	39.0	21	5020.079.216	50
21.2	M20x1.5	16.5	29.5	24.0	12.5	49.0	27	5020.079.220	50
28.5	M25x1.5	17.0	37.0	30.0	13.5	54.0	34	5020.079.225	25
34.5	M32x1.5	24.0	44.0	35.0	15.0	55.5	40	5020.079.232	25
42.5	M40x1.5	33.0	52.0	44.5	20.0	63.0	50	5020.079.240	25



# Kunststoff Schlauchverschraubung gerade mit Messing Innengewinde

## Synthetic straight conduit connector with brass inner thread

### Anschlussgewinde metrisch | Entry thread metric

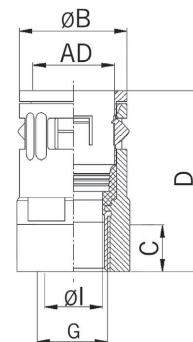

Material: Flexamid V0 (HL 3)  
 Gewinde: Messing vernickelt  
 Dichtung: TPE  
 Brandklasse: V0 (UL 94)  
 Eigenschaften: Schnelle und ausreissfeste Montage durch «push-in»-Verschluss, einfache Demontage durch Andrücken der Rasthülse  
 Schutzart: IP 68 / IP 69  
 Einsatztemperatur: -40°C / +120°C

Material: Flexamide V0 (HL 3)  
 Entry thread: Nickel-plated brass  
 Seal: TPE  
 Fire classification: V0 (UL 94)  
 Properties: Quick and pull-out-proof installation by means of the «push-in» lock, simple dismounting by displacing the snap-in sleeve  
 Protection class: IP 68 / IP 69  
 Temperature range: -40°C / +120°C



Quick-Verschraubung RQGK2-M  
 Schwarz

Quick connector RQGK2-M  
 Black

AD mm	G	ØI mm	ØB mm	C mm	D mm	 mm	Art.-Nr.   Art. No.	
10.0	M12x1.5	7.0	20.0	7.5	38.5	18	5108.010.212	50
13.0	M16x1.5	8.5	24.0	9.0	42.0	22	5108.013.216	50
15.8	M20x1.5	10.0	27.0	10.0	43.5	25	5108.015.220	50
21.2	M20x1.5	15.0	33.0	11.0	50.0	30	5108.021.220	25
21.2	M25x1.5	16.0	33.0	11.0	50.0	30	5108.021.225	25
28.5	M25x1.5	18.0	43.0	13.0	53.0	41	5108.028.225	25
34.5	M32x1.5	24.0	48.0	13.0	58.0	46	5108.034.232	25
42.5	M40x1.5	32.0	58.0	15.0	85.0	55	5108.042.240	10
54.5	M50x1.5	39.0	68.0	17.0	98.0	65	5108.054.250	10





### Anschlussgewinde Pg | Entry thread Pg



Quick-Verschraubung RQGK2-P  
 Schwarz

Quick connector RQGK2-P  
 Black

AD mm	G	ØI mm	ØB mm	C mm	D mm	 mm	Art.-Nr.   Art. No.	
10.0	Pg 7	7.0	20.0	8.0	38.0	18	5020.075.207	50
13.0	Pg 9	8.5	24.0	9.0	42.0	22	5020.075.209	50
15.8	Pg 11	11.0	27.0	9.0	44.0	25	5020.075.211	50
18.5	Pg 13	12.5	29.0	9.5	47.5	26	5020.075.213	50
21.2	Pg 16	16.0	33.0	13.0	51.0	31	5020.075.216	25
28.5	Pg 21	20.0	41.0	13.0	55.0	39	5020.075.221	25
34.5	Pg 29	27.5	48.0	14.0	59.0	46	5020.075.229	25
42.5	Pg 36	36.0	60.0	15.5	85.0	55	5020.075.236	10
54.5	Pg 48	42.5	72.0	16.0	98.0	65	5020.075.248	10



# Kunststoff Schlauchverschraubung gerade mit integrierter Zugentlastung

## Synthetic straight conduit connector with integrated strain-relief

### Anschlussgewinde metrisch | Entry thread metric

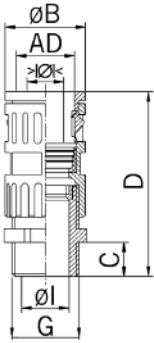

Material: Polyamid schlagfest  
 Dichtung: TPE  
 Brandklasse: HB (UL 94)  
 Eigenschaften: Schnelle und ausreissfeste Montage durch «push-in»-Verschluss, einfache Demontage durch Andrücken der Rasthülse  
 Einsatzbereich: mit integrierter Zugentlastung  
 Schutzart: IP 68 / IP 69  
 Einsatztemperatur: -40°C / +120°C

Material: Polyamide impact-resistant  
 Seal: TPE  
 Fire classification: HB (UL 94)  
 Properties: Quick and pull-out-proof installation by means of the «push-in» lock, simple dismounting by displacing the snap-in sleeve  
 Application: With integrated strain-relief  
 Protection class: IP 68 / IP 69  
 Temperature range: -40°C / +120°C



Quick-Verschraubung RQGZ-M  
Schwarz

Quick connector RQGZ-M  
Black

AD mm	G	>Ø< min mm	>Ø< max mm	ØI mm	ØB mm	C mm	D mm	h <sub>1</sub> mm	h <sub>2</sub> mm	Art.-Nr.   Art. No.	
10.0	M12x1.5	4.0	6.5	6.5	17.0	8	51	16	15	5020.031.212	20
13.0	M16x1.5	5.0	9.5	9.5	20.0	8	53	18	20	5020.031.216	20
15.8	M20x1.5	8.0	11.0	13.0	23.0	8	59	21	24	5020.031.220	20
21.2	M25x1.5	11.0	16.0	16.0	33.5	8	70	27	29	5020.031.225	10
28.5	M32x1.5	15.0	18.0	18.0	37.0	11	82	34	36	5020.031.232	10
34.5	M40x1.5	16.0	25.0	25.0	44.0	10	85	40	46	5020.031.240	10
42.5	M50x1.5	27.0	32.0	32.0	58.0	13	141	55	55	5020.031.250	10
54.5	M63x1.5	32.0	42.0	44.0	68.0	14	145	65	68	5020.031.263	10



Quick-Verschraubung RQGZ-M  
Grau

Quick connector RQGZ-M  
Grey

AD mm	G	>Ø< min mm	>Ø< max mm	ØI mm	ØB mm	C mm	D mm	h <sub>1</sub> mm	h <sub>2</sub> mm	Art.-Nr.   Art. No.	
10.0	M12x1.5	4.0	6.5	6.5	17.0	8	51	16	15	5020.031.012	20
13.0	M16x1.5	5.0	9.5	9.5	20.0	8	53	18	20	5020.031.016	20
15.8	M20x1.5	8.0	11.0	13.0	23.0	8	59	21	24	5020.031.020	20
21.2	M25x1.5	11.0	16.0	16.0	33.5	8	70	27	29	5020.031.025	10
28.5	M32x1.5	15.0	18.0	18.0	37.0	11	82	34	36	5020.031.032	10
34.5	M40x1.5	16.0	25.0	25.0	44.0	10	85	40	46	5020.031.040	10
42.5	M50x1.5	27.0	32.0	32.0	58.0	13	141	55	55	5020.031.050	10
54.5	M63x1.5	32.0	42.0	44.0	68.0	14	145	65	68	5020.031.063	10



# Kunststoff Schlauchverschraubung gerade mit integrierter Zugentlastung

## Synthetic straight conduit connector with integrated strain-relief

Anschlussgewinde Pg | Entry thread Pg

Material: Polyamid schlagfest  
 Dichtung: TPE  
 Brandklasse: HB (UL 94)  
 Eigenschaften: Schnelle und ausreissfeste Montage durch «push-in»-Verschluss, einfache Demontage durch Andrücken der Rasthülse  
 Einsatzbereich: mit integrierter Zugentlastung  
 Schutzart: IP 68 / IP 69  
 Einsatztemperatur: -40°C / +120°C

Material: Polyamide impact-resistant  
 Seal: TPE  
 Fire classification: HB (UL 94)  
 Properties: Quick and pull-out-proof installation by means of the «push-in» lock, simple dismounting by displacing the snap-in sleeve  
 Application: With integrated strain-relief  
 Protection class: IP 68 / IP 69  
 Temperature range: -40°C / +120°C

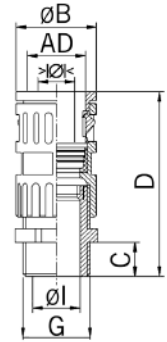

Quick-Verschraubung RQGZ-P  
Schwarz

Quick connector RQGZ-P  
Black

AD mm	G	>Ø< min mm	>Ø< max mm	ØI mm	ØB mm	C mm	D mm	h <sub>1</sub> mm	h <sub>2</sub> mm	Art.-Nr.   Art. No.	
10.0	Pg 7	3.0	6.5	7	17.0	8	51	16	15	5020.034.207	20
13.0	Pg 9	4.0	8.0	8	20.0	8	53	18	19	5020.034.209	20
15.8	Pg 11	5.0	10.0	10	23.0	8	59	21	22	5020.034.211	20
15.8	Pg 13	6.0	11.0	11	27.0	8	59	21	24	5020.034.213	20
18.5	Pg 13	6.0	12.0	12	27.0	8	59	24	24	5020.034.214	20
21.2	Pg 13	6.0	12.0	12	29.5	8	70	27	24	5020.034.215	10
21.2	Pg 16	10.0	14.0	14	29.5	10	72	27	27	5020.034.216	10
28.5	Pg 21	13.0	18.0	20	37.0	11	82	34	33	5020.034.221	10
34.5	Pg 29	18.0	25.0	25	44.0	12	85	40	42	5020.034.229	10
42.5	Pg 36	22.0	32.0	32	58.0	13	140	55	53	5020.034.236	10
54.5	Pg 48	34.0	44.0	44	68.0	14	144	65	65	5020.034.248	10



Quick-Verschraubung RQGZ-P  
Grau

Quick connector RQGZ-P  
Grey

AD mm	G	>Ø< min mm	>Ø< max mm	ØI mm	ØB mm	C mm	D mm	h <sub>1</sub> mm	h <sub>2</sub> mm	Art.-Nr.   Art. No.	
10.0	Pg 7	3.0	6.5	7	17.0	8	51	16	15	5020.034.007	20
13.0	Pg 9	4.0	8.0	8	20.0	8	53	18	19	5020.034.009	20
15.8	Pg 11	5.0	10.0	10	23.0	8	59	21	22	5020.034.011	20
15.8	Pg 13	6.0	11.0	11	27.0	8	59	21	24	5020.034.013	20
18.5	Pg 13	6.0	12.0	12	27.0	8	59	24	24	5020.034.014	20
21.2	Pg 13	6.0	12.0	12	29.5	8	70	27	24	5020.034.015	10
21.2	Pg 16	10.0	14.0	14	29.5	10	72	27	27	5020.034.016	10
28.5	Pg 21	13.0	18.0	20	37.0	11	82	34	33	5020.034.021	10
34.5	Pg 29	18.0	25.0	25	44.0	12	85	40	42	5020.034.029	10
42.5	Pg 36	22.0	32.0	32	58.0	13	140	55	53	5020.034.036	10
54.5	Pg 48	34.0	44.0	44	68.0	14	144	65	65	5020.034.048	10



# Kunststoff Schlauchverschraubung gerade mit Steckanschluss

## Synthetic straight conduit connector with plug-type connection

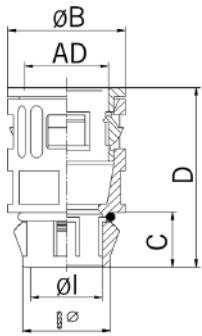

Material:	Polyamid schlagfest	Material:	Polyamide impact-resistant
Dichtung:	Schlauchanschluss dichtend	Seal:	Conically sealing connection
O-Ring :	NBR	O-ring :	NBR
Brandklasse:	V0 (UL 94)	Fire classification:	V0 (UL 94)
Eigenschaften:	Schnelle und ausreissfeste Montage durch «push-in»-Ver- schluss, einfache Demontage durch Andrücken der Rasthülse	Properties:	Quick and pull-out-proof instal- lation by means of the «push- in» lock, simple dismounting by displacing the snap-in sleeve
Einsatzbereich:	Für Bohrungen in Wandstärken 1 - 2.5 mm	Application:	For bore holes for wall thickness from 1 - 2.5 mm
Schutzart:	IP 66	Protection class:	IP 66
Einsatztemperatur:	-40°C / +120°C	Temperature range:	-40°C / +120°C



Quick-Verschraubung RQG1-S  
Schwarz

Quick connector RQG1-S  
Black

AD mm	$\varnothing$ mm	$\varnothing$ I mm	$\varnothing$ B mm	C mm	D mm	Art.-Nr.   Art. No.	
10.0	12.0	7.0	17.0	11.7	34.5	5020.082.207	50
13.0	12.0	9.0	20.0	12.0	37.0	5020.082.212	50
13.0	15.0	10.0	20.0	13.6	38.6	5020.082.209	50
15.8	16.0	11.8	23.0	13.5	40.5	5020.382.216	50
15.8	18.0	12.5	23.0	13.5	40.5	5020.082.211	50
21.2	20.0	15.2	29.5	13.8	45.3	5020.082.220	50
21.2	22.0	18.0	29.5	13.8	45.3	5020.082.216	50
28.5	25.0	21.0	37.0	17.5	51.0	5020.382.225	50
28.5	28.0	23.5	37.0	17.9	51.9	5020.082.221	25
34.5	37.0	30.5	44.0	18.7	54.7	5020.082.229	25
42.5	47.0	36.5	52.0	21.0	60.0	5020.082.236	25
54.5	50.0	43.0	64.0	21.0	63.0	5020.382.250	10



Quick-Verschraubung RQG1-S  
Grau

Quick connector RQG1-S  
Grey

AD mm	$\varnothing$ mm	$\varnothing$ I mm	$\varnothing$ B mm	C mm	D mm	Art.-Nr.   Art. No.	
10.0	12.0	7.0	17.0	11.7	34.5	5020.082.007	50
13.0	15.0	10.0	20.0	13.6	38.6	5020.082.009	50
15.8	18.0	12.5	23.0	13.5	40.5	5020.082.011	50
21.2	22.0	18.0	29.5	13.8	45.3	5020.082.016	50
28.5	28.0	23.5	37.0	17.9	51.9	5020.082.021	25
34.5	37.0	30.5	44.0	18.7	54.7	5020.082.029	25
42.5	47.0	36.5	52.0	21.0	60.0	5020.082.036	25



# Kunststoff Schlauchverschraubung gerade für Verbindung auf Installationsrohre

## Synthetic straight conduit connector for connection to solid tubes

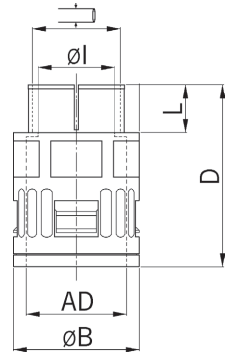

Material: Flexamid V0 (HL 3)  
 Dichtung: TPE  
 Brandklasse: V0 (UL 94)  
 Einsatzbereich: Einfache Verbindung von Ringwellschläuchen mit starrem Installationsrohr  
 Schutzart: IP 54 (mit Dichtmittel bis IP 68 möglich)  
 Einsatztemperatur: -40°C / +120°C

Material: Flexamide V0 (HL 3)  
 Seal: TPE  
 Fire classification: V0 (UL 94)  
 Application: Simple connection of corrugated tubing and rigid installation tube  
 Protection class: IP 54 (IP 68 possible when using sealing products)  
 Temperature range: -40°C / +120°C



### Quick-Verschraubung RQGST-M Schwarz



### Quick connector RQGST-M Black

AD mm	 ø mm	ØI mm	ØB mm	D mm	L mm	Art.-Nr.   Art. No.	
15.8	M16	12.5	23.0	41.0	13.0	5604.015.216	50
21.2	M20	17.0	29.5	45.0	13.0	5604.021.220	50
28.5	M25	20.5	37.0	49.5	15.0	5604.028.225	25
34.5	M32	25.5	44.0	52.5	15.0	5604.034.232	25
42.5	M40	32.0	52.0	54.5	16.5	5604.042.240	25
54.5	M50	42.5	64.0	55.5	17.0	5604.054.250	10



### Quick-Verschraubung RQGST-M Grau

### Quick connector RQGST-M Grey

AD mm	 ø mm	ØI mm	ØB mm	D mm	L mm	Art.-Nr.   Art. No.	
15.8	M16	12.5	23.0	41.0	13.0	5604.015.016	50
21.2	M20	17.0	29.5	45.0	13.0	5604.021.020	50
28.5	M25	20.5	37.0	49.5	15.0	5604.028.025	25
34.5	M32	25.5	44.0	52.5	15.0	5604.034.032	25
42.5	M40	32.0	52.0	54.5	16.5	5604.042.040	25
54.5	M50	42.5	64.0	55.5	17.0	5604.054.050	10



# Kunststoff Schlauchverschraubung Winkel 90°

## Synthetic conduit connector elbow 90°

### Anschlussgewinde metrisch | Entry thread metric

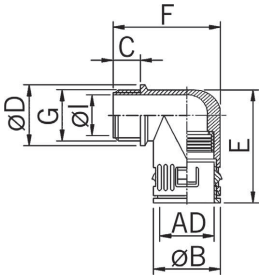

Material: Polyamid schlagfest  
 Dichtung: TPE  
 Brandklasse: V0 (UL 94)  
 Eigenschaften: Schnelle und ausreissfeste Montage durch «push-in»-Verschluss, einfache Demontage durch Andrücken der Rasthülse  
 Schutzart: IP 68 / IP 69  
 Einsatztemperatur: -40°C / +120°C

Material: Polyamide impact-resistant  
 Seal: TPE  
 Fire classification: V0 (UL 94)  
 Properties: Quick and pull-out-proof installation by means of the «push-in» lock, simple dismantling by displacing the snap-in sleeve  
 Protection class: IP 68 / IP 69  
 Temperature range: -40°C / +120°C



Quick-Verschraubung RQW-M  
Schwarz

Quick connector RQW-M  
Black

AD mm	G	ØI mm	ØB mm	C mm	E mm	F mm	ØD mm	Art.-Nr.   Art. No.	
10.0	M10x1.0	6.0	17.0	11.0	33.5	34.0	16.0	5020.064.210	50
13.0	M12x1.5	8.0	20.0	12.0	36.0	36.5	20.0	5020.064.212	50
13.0	M16x1.5	12.0	20.0	12.0	36.0	36.5	20.0	5020.036.216	50
15.8	M16x1.5	12.0	23.0	12.0	42.0	40.5	23.0	5020.064.216	50
15.8	M20x1.5	15.5	23.0	13.0	42.0	41.5	24.0	5020.036.220	50
21.2	M20x1.5	14.8	29.5	13.0	50.0	49.0	27.0	5020.064.220	50
21.2	M25x1.5	18.0	29.5	13.0	50.0	49.0	29.5	5020.036.225	50
28.5	M25x1.5	18.0	37.0	13.0	57.0	57.0	34.0	5020.064.225	25
28.5	M32x1.5	24.0	37.0	15.0	57.0	59.0	37.0	5020.036.232	25
34.5	M32x1.5	24.0	44.0	15.0	67.5	67.0	43.0	5020.064.232	10
34.5	M40x1.5	32.0	44.0	15.0	67.5	67.0	45.0	5020.036.240	10
42.5	M40x1.5	32.0	52.0	15.0	83.0	74.5	52.0	5020.064.240	10
42.5	M50x1.5	39.0	52.0	15.5	83.0	75.5	55.0	5020.036.250	10
54.5	M50x1.5	39.0	64.0	16.0	88.0	86.5	64.0	5020.064.250	5
54.5	M63x1.5	53.0	64.0	16.0	88.0	86.5	68.0	5020.036.263	5

Auf Anfrage lieferbar:

Available on request:

Ausführungen mit CTG oder NPT Anschlussgewinde

Executions with CTG or NPT entry thread



Quick-Verschraubung RQW-M  
Grau

Quick connector RQW-M  
Grey

AD mm	G	ØI mm	ØB mm	C mm	E mm	F mm	ØD mm	Art.-Nr.   Art. No.	
10.0	M10x1.0	6.0	17.0	11.0	33.5	34.0	16.0	5020.064.010	50
13.0	M12x1.5	8.0	20.0	12.0	36.0	36.5	20.0	5020.064.012	50
13.0	M16x1.5	12.0	20.0	12.0	36.0	36.5	20.0	5020.036.016	50
15.8	M16x1.5	12.0	23.0	12.0	42.0	40.5	23.0	5020.064.016	50
15.8	M20x1.5	15.5	23.0	13.0	42.0	41.5	24.0	5020.036.020	50
21.2	M20x1.5	14.8	29.5	13.0	50.0	49.0	27.0	5020.064.020	50
21.2	M25x1.5	18.0	29.5	13.0	50.0	49.0	29.5	5020.036.025	50
28.5	M25x1.5	18.0	37.0	13.0	57.0	57.0	34.0	5020.064.025	25
28.5	M32x1.5	24.0	37.0	15.0	57.0	59.0	37.0	5020.036.032	25
34.5	M32x1.5	24.0	44.0	15.0	67.5	67.0	43.0	5020.064.032	10
34.5	M40x1.5	32.0	44.0	15.0	67.5	67.0	45.0	5020.036.040	10
42.5	M40x1.5	32.0	52.0	15.0	83.0	74.5	52.0	5020.064.040	10
42.5	M50x1.5	39.0	52.0	15.5	83.0	75.5	55.0	5020.036.050	10
54.5	M50x1.5	39.0	64.0	16.0	88.0	86.5	64.0	5020.064.050	5
54.5	M63x1.5	53.0	64.0	16.0	88.0	86.5	68.0	5020.036.063	5

# Kunststoff Schlauchverschraubung Winkel 90°

## Synthetic conduit connector elbow 90°

Anschlussgewinde Pg | Entry thread Pg

Material: Polyamid schlagfest  
 Dichtung: TPE  
 Brandklasse: V0 (UL 94)  
 Eigenschaften: Schnelle und ausreissfeste Montage durch «push-in»-Verschluss, einfache Demontage durch Andrücken der Rasthülse  
 Schutzart: IP 68 / IP 69  
 Einsatztemperatur: -40°C / +120°C

Material: Polyamide impact-resistant  
 Seal: TPE  
 Fire classification: V0 (UL 94)  
 Properties: Quick and pull-out-proof installation by means of the «push-in» lock, simple dismounting by displacing the snap-in sleeve  
 Protection class: IP 68 / IP 69  
 Temperature range: -40°C / +120°C

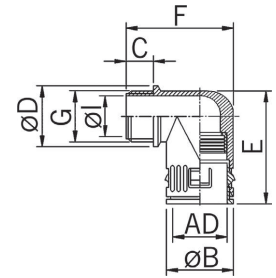

Quick-Verschraubung RQW-P Schwarz								Quick connector RQW-P Black		
AD mm	G	ØI mm	ØB mm	C mm	E mm	F mm	ØD mm	Art.-Nr.   Art. No.		
10.0	Pg 7	7.0	17.0	9.5	33.5	32.0	16.0	5020.028.207	50	
13.0	Pg 9	12.0	20.0	10.0	36.0	34.0	20.0	5020.028.209	50	
13.0	Pg 11	14.0	20.0	10.0	39.0	34.0	23.0	5020.029.211	50	
13.0	Pg 13	15.5	20.0	10.0	40.0	35.0	25.0	5020.029.213	50	
15.8	Pg 11	15.5	23.0	10.0	42.0	37.5	24.5	5020.028.211	50	
18.5	Pg 13	13.5	26.5	13.0	46.0	46.0	27.0	5020.028.213	50	
21.2	Pg 16	18.0	29.5	13.0	50.0	48.0	27.0	5020.028.216	50	
28.5	Pg 21	24.0	37.0	13.0	57.0	56.0	34.0	5020.028.221	25	
34.5	Pg 29	32.0	44.0	14.0	67.5	64.5	43.0	5020.028.229	10	
42.5	Pg 36	36.5	52.0	14.0	83.0	70.0	51.5	5020.028.236	10	
54.5	Pg 48	48.5	64.0	14.0	88.0	83.0	65.0	5020.028.248	5	

Auf Anfrage lieferbar: Available on request:  
 Ausführungen mit CTG oder NPT Anschlussgewinde Executions with CTG or NPT entry thread



Quick-Verschraubung RQW-P Grau								Quick connector RQW-P Grey		
AD mm	G	ØI mm	ØB mm	C mm	E mm	F mm	ØD mm	Art.-Nr.   Art. No.		
10.0	Pg 7	7.0	17.0	9.5	33.5	32.0	16.0	5020.028.007	50	
13.0	Pg 9	12.0	20.0	10.0	36.0	34.0	20.0	5020.028.009	50	
15.8	Pg 11	15.5	23.0	10.0	42.0	37.5	24.5	5020.028.011	50	
18.5	Pg 13	13.5	26.5	13.0	46.0	46.0	27.0	5020.028.013	50	
21.2	Pg 16	18.0	29.5	13.0	50.0	48.0	27.0	5020.028.016	50	
28.5	Pg 21	24.0	37.0	13.0	57.0	56.0	34.0	5020.028.021	25	
34.5	Pg 29	32.0	44.0	14.0	67.5	64.5	43.0	5020.028.029	10	
42.5	Pg 36	36.5	52.0	14.0	83.0	70.0	51.5	5020.028.036	10	
54.5	Pg 48	48.5	64.0	14.0	88.0	83.0	65.0	5020.028.048	5	



# Kunststoff Schlauchverschraubung Winkel 90° konisch dichtend

## Synthetic conduit connector elbow 90° conically sealing

### Anschlussgewinde metrisch | Entry thread metric

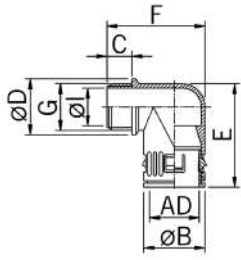

Material: Polyamid schlagfest  
 Dichtung: Schlauchanschluss konisch dichtend  
 Brandklasse: V0 (UL 94)  
 Eigenschaften: Schnelle und ausreissfeste Montage durch «push-in»-Verschluss, einfache Demontage durch Andrücken der Rasthülse  
 Schutzart: IP 66  
 Einsatztemperatur: -40°C / +120°C

Material: Polyamide impact-resistant  
 Seal: Conically sealing connection  
 Fire classification: V0 (UL 94)  
 Properties: Quick and pull-out-proof installation by means of the «push-in» lock, simple dismounting by displacing the snap-in sleeve  
 Protection class: IP 66  
 Temperature range: -40°C / +120°C



Quick-Verschraubung RQW1-M  
Schwarz

Quick connector RQW1-M  
Black

AD mm	G	ØI mm	ØB mm	C mm	E mm	F mm	ØD mm	Art.-Nr.   Art. No.	
10.0	M10x1.0	6.0	17.0	12.0	33.5	34.0	16.0	5020.051.210	50
13.0	M12x1.5	8.0	20.0	12.0	36.0	36.5	20.0	5020.051.212	50
13.0	M16x1.5	12.0	20.0	12.0	36.0	36.5	20.0	5020.051.216	50
15.8	M16x1.5	12.0	23.0	12.0	42.0	40.5	23.0	5020.051.218	50
15.8	M20x1.5	15.5	23.0	13.0	42.0	41.5	24.0	5020.051.220	50
21.2	M20x1.5	14.8	29.5	13.0	50.0	49.0	27.0	5020.051.222	50
21.2	M25x1.5	18.0	29.5	13.0	50.0	49.0	29.5	5020.051.225	50
28.5	M25x1.5	18.0	37.0	13.0	57.0	57.0	34.0	5020.051.228	25
28.5	M32x1.5	24.0	37.0	15.0	57.0	59.0	37.0	5020.051.232	25
34.5	M32x1.5	24.0	44.0	15.0	67.5	67.0	43.0	5020.051.234	10
34.5	M40x1.5	32.0	44.0	15.0	67.5	67.0	45.0	5020.051.240	10
42.5	M40x1.5	32.0	52.0	15.0	83.0	74.5	52.0	5020.051.242	10
42.5	M50x1.5	39.0	52.0	15.5	83.0	75.5	55.0	5020.051.250	10
54.5	M50x1.5	39.0	64.0	16.0	88.0	86.0	64.0	5020.051.254	5
54.5	M63x1.5	53.0	64.0	16.0	88.0	86.5	68.0	5020.051.263	5

Auf Anfrage lieferbar:

Available on request:

Ausführungen mit NPT Gewinde

Executions with NPT entry thread



Quick-Verschraubung RQW1-M  
Grau

Quick connector RQW1-M  
Grey

AD mm	G	ØI mm	ØB mm	C mm	E mm	F mm	ØD mm	Art.-Nr.   Art. No.	
10.0	M10x1.0	6.0	17.0	12.0	33.5	34.0	16.0	5020.051.010	50
13.0	M12x1.5	8.0	20.0	12.0	36.0	36.5	20.0	5020.051.012	50
13.0	M16x1.5	12.0	20.0	12.0	36.0	36.5	20.0	5020.051.016	50
15.8	M16x1.5	12.0	23.0	12.0	42.0	40.5	23.0	5020.051.018	50
15.8	M20x1.5	15.5	23.0	13.0	42.0	41.5	24.0	5020.051.020	50
21.2	M20x1.5	14.8	29.5	13.0	50.0	49.0	27.0	5020.051.022	50
21.2	M25x1.5	18.0	29.5	13.0	50.0	49.0	29.5	5020.051.025	50
28.5	M25x1.5	18.0	37.0	13.0	57.0	57.0	34.0	5020.051.028	25
28.5	M32x1.5	24.0	37.0	15.0	57.0	59.0	37.0	5020.051.032	25
34.5	M32x1.5	24.0	44.0	15.0	67.5	67.0	43.0	5020.051.034	10
34.5	M40x1.5	32.0	44.0	15.0	67.5	67.0	45.0	5020.051.040	10
42.5	M40x1.5	32.0	52.0	15.0	83.0	74.5	52.0	5020.051.042	10
42.5	M50x1.5	39.0	52.0	15.5	83.0	75.5	55.0	5020.051.050	10
54.5	M50x1.5	39.0	64.0	16.0	88.0	86.0	64.0	5020.051.054	5
54.5	M63x1.5	53.0	64.0	16.0	88.0	86.5	68.0	5020.051.063	5



# Kunststoff Schlauchverschraubung Winkel 90° konisch dichten

## Synthetic conduit connector elbow 90° conically sealing

Anschlussgewinde Pg | Entry thread Pg

Material: Polyamid schlagfest  
Dichtung: Schlauchanschluss konisch dichtend

Brandklasse: V0 (UL 94)  
Eigenschaften: Schnelle und ausreissfeste Montage durch «push-in»-Verschluss, einfache Demontage durch Andrücken der Rasthülse

Schutzart: IP 66  
Einsatztemperatur: -40°C / +120°C

Material: Polyamide impact-resistant  
Seal: Conically sealing connection

Fire classification: V0 (UL 94)  
Properties: Quick and pull-out-proof installation by means of the «push-in» lock, simple dismantling by displacing the snap-in sleeve

Protection class: IP 66  
Temperature range: -40°C / +120°C

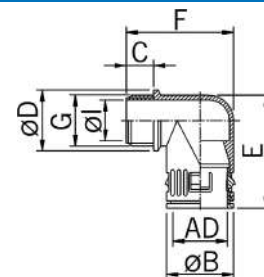

Quick-Verschraubung RQW1-P  
Schwarz

Quick connector RQW1-P  
Black

AD mm	G	ØI mm	ØB mm	C mm	E mm	F mm	ØD mm	Art.-Nr.   Art. No.	
10.0	Pg 7	7.0	17.0	10.0	33.5	32.0	16.0	5020.050.207	50
13.0	Pg 9	12.0	20.0	10.0	36.0	34.0	20.0	5020.050.209	50
15.8	Pg 11	15.5	23.0	10.0	42.0	37.5	24.5	5020.050.211	50
18.5	Pg 13	13.5	26.5	13.0	46.0	46.0	27.0	5020.050.213	50
21.2	Pg 16	18.0	29.5	13.0	50.0	48.0	27.0	5020.050.216	50
28.5	Pg 21	24.0	37.0	13.0	57.0	56.0	34.0	5020.050.221	25
34.5	Pg 29	32.0	44.0	14.0	67.5	64.5	43.0	5020.050.229	10
42.5	Pg 36	36.5	52.0	14.0	83.0	70.0	51.5	5020.050.236	10
54.5	Pg 48	48.5	64.0	14.0	88.0	83.0	64.0	5020.050.248	5

Auf Anfrage lieferbar:  
Ausführungen mit NPT Gewinde

Available on request:  
Executions with NPT entry thread



Quick-Verschraubung RQW1-P  
Grau

Quick connector RQW1-P  
Grey

AD mm	G	ØI mm	ØB mm	C mm	E mm	F mm	ØD mm	Art.-Nr.   Art. No.	
10.0	Pg 7	7.0	17.0	10.0	33.5	32.0	16.0	5020.050.007	50
13.0	Pg 9	12.0	20.0	10.0	36.0	34.0	20.0	5020.050.009	50
15.8	Pg 11	15.5	23.0	10.0	42.0	37.5	24.5	5020.050.011	50
18.5	Pg 13	13.5	26.5	13.0	46.0	46.0	27.0	5020.050.013	50
21.2	Pg 16	18.0	29.5	13.0	50.0	48.0	27.0	5020.050.016	50
28.5	Pg 21	24.0	37.0	13.0	57.0	56.0	34.0	5020.050.021	25
34.5	Pg 29	32.0	44.0	14.0	67.5	64.5	43.0	5020.050.029	10
42.5	Pg 36	36.5	52.0	14.0	83.0	70.0	51.5	5020.050.036	10
54.5	Pg 48	48.5	64.0	14.0	88.0	83.0	64.0	5020.050.048	5



# Kunststoff Schlauchverschraubung Winkel 90° mit Flansch

## Synthetic conduit connector elbow 90° with flange

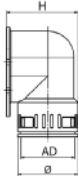
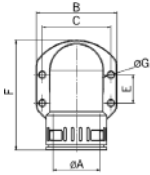

Material: Polyamid schlagfest  
 Dichtring: TPE  
 Dichtung: Flanschdichtungen  
 Brandklasse: V0 (UL 94)  
 Eigenschaften: Schnelle und ausreissfeste Montage durch «push-in»-Verschluss, einfache Demontage durch Andrücken der Rasthülse  
 Schutzart: IP 68 / IP 69  
 Einsatztemperatur: -40°C / +120°C

Material: Polyamide impact-resistant  
 Sealing ring: TPE  
 Seal: Sealing for flanged sleeves  
 Fire classification: V0 (UL 94)  
 Properties: Quick and pull-out-proof installation by means of the «push-in» lock, simple dismounting by displacing the snap-in sleeve  
 Protection class: IP 68 / IP 69  
 Temperature range: -40°C / +120°C



Quick-Verschraubung RQW-F Schwarz									Quick connector RQW-F Black		
AD mm	ØA mm	B mm	C mm	F mm	Ø mm	ØG mm	H mm	E mm	Art.-Nr.   Art. No.		
28.5	27	65	50	88	45	6.6	37	-	5020.077.221	10	
34.5	33	67	52	110	50	6.6	44	36	5020.077.229	10	
42.5	38	85	70	104	64.5	6.6	52	30	5020.077.236	10	
54.5	50	86	71	121	76	6.6	64	30	5020.077.248	10	



Quick-Verschraubung RQW-F Grau									Quick connector RQW-F Grey		
AD mm	ØA mm	B mm	C mm	F mm	Ø mm	ØG mm	H mm	E mm	Art.-Nr.   Art. No.		
28.5	27	65	50	88	45	6.6	37	-	5020.077.021	10	
34.5	33	67	52	110	50	6.6	44	36	5020.077.029	10	
42.5	38	85	70	104	64.5	6.6	52	30	5020.077.036	10	
54.5	50	86	71	121	76	6.6	64	30	5020.077.048	10	

# Kunststoff Schlauchverschraubung Bogen 90°

## Synthetic conduit connector 90° bend

### Anschlussgewinde metrisch | Entry thread metric

Material: Polyamid schlagfest  
 Dichtung: TPE  
 Brandklasse: V0 (UL 94)  
 Eigenschaften: Schnelle und ausreissfeste Montage durch «push-in»-Verschluss, einfache Demontage durch Andrücken der Rasthülse  
 Schutzart: IP 68 / IP 69  
 Einsatztemperatur: -40°C / +120°C

Material: Polyamide impact-resistant  
 Seal: TPE  
 Fire classification: V0 (UL 94)  
 Properties: Quick and pull-out-proof installation by means of the «push-in» lock, simple dismounting by displacing the snap-in sleeve  
 Protection class: IP 68 / IP 69  
 Temperature range: -40°C / +120°C

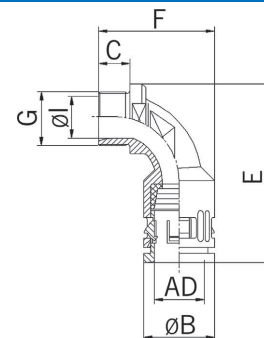

Quick-Verschraubung RQB90-M  
Schwarz

Quick connector RQB90-M  
Black

AD mm	G	ØI mm	ØB mm	C mm	E mm	F mm	Ø mm	Art.-Nr.   Art. No.	
10.0	M12x1.5	6.5	17.0	10.0	57.0	39.0	18	5103.010.212	50
13.0	M16x1.5	8.5	20.0	12.0	59.0	40.5	21	5103.013.216	50
15.8	M20x1.5	10.0	23.0	12.0	62.0	45.0	24	5103.015.220	50
21.2	M20x1.5	13.0	29.5	13.0	73.0	48.0	26	5103.021.220	50
21.2	M25x1.5	14.5	29.5	13.0	73.0	48.0	26	5103.021.225	50
28.5	M25x1.5	17.0	37.0	14.0	85.0	64.0	32	5103.028.225	25
28.5	M32x1.5	20.0	37.0	14.0	85.0	64.0	36	5103.028.232	25
34.5	M32x1.5	23.0	44.0	14.0	100.5	74.0	39	5103.034.232	10
34.5	M40x1.5	29.0	44.0	14.0	100.5	74.0	45	5103.034.240	10
42.5	M40x1.5	31.5	52.0	17.0	111.0	82.5	48	5103.042.240	10
42.5	M50x1.5	39.0	52.0	17.0	111.0	82.5	59	5103.042.250	10
54.5	M50x1.5	35.5	64.0	17.0	124.5	97.0	60	5103.054.250	5
54.5	M63x1.5	45.5	64.0	17.0	124.5	97.0	70	5103.054.263	5



Quick-Verschraubung RQB90-M  
Grau

Quick connector RQB90-M  
Grey

AD mm	G	ØI mm	ØB mm	C mm	E mm	F mm	Ø mm	Art.-Nr.   Art. No.	
10.0	M12x1.5	6.5	17.0	10.0	57.0	39.0	18	5103.010.012	50
13.0	M16x1.5	8.5	20.0	12.0	59.0	40.5	21	5103.013.016	50
15.8	M20x1.5	10.0	23.0	12.0	62.0	45.0	24	5103.015.020	50
21.2	M20x1.5	13.0	29.5	13.0	73.0	48.0	26	5103.021.020	50
21.2	M25x1.5	14.5	29.5	13.0	73.0	48.0	26	5103.021.025	50
28.5	M25x1.5	17.0	37.0	14.0	85.0	64.0	32	5103.028.025	25
28.5	M32x1.5	20.0	37.0	14.0	85.0	64.0	36	5103.028.032	25
34.5	M32x1.5	23.0	44.0	14.0	100.5	74.0	39	5103.034.032	10
34.5	M40x1.5	29.0	44.0	14.0	100.5	74.0	45	5103.034.040	10
42.5	M40x1.5	31.5	52.0	17.0	111.0	82.5	48	5103.042.040	10
42.5	M50x1.5	36.0	52.0	17.0	111.0	82.5	59	5103.042.050	10
54.5	M50x1.5	35.5	64.0	17.0	124.5	97.0	60	5103.054.050	5
54.5	M63x1.5	45.5	64.0	17.0	124.5	97.0	70	5103.054.063	5



### Anschlussgewinde Pg | Entry thread Pg



Quick-Verschraubung RQB90-P  
Schwarz

Quick connector RQB90-P  
Black

AD mm	G	ØI mm	ØB mm	C mm	E mm	F mm	Ø mm	Art.-Nr.   Art. No.	
10.0	Pg 7	6.5	17.0	10.0	57.0	39.0	18	5020.090.207	50
13.0	Pg 9	8.5	20.0	12.0	59.5	40.5	21	5020.090.209	50
15.8	Pg 11	10.0	23.0	12.0	62.0	44.5	24	5020.090.211	50
18.5	Pg 13	12.5	25.0	12.0	64.0	47.0	27	5020.090.213	50
21.2	Pg 16	14.5	29.5	13.0	73.2	48.0	26	5020.090.216	50
28.5	Pg 21	20.0	37.0	14.0	85.0	64.0	36	5020.090.221	25
34.5	Pg 29	29.0	44.0	14.0	100.5	74.0	46	5020.090.229	10
42.5	Pg 36	36.0	52.0	17.0	111.0	82.5	58	5020.090.236	10
54.5	Pg 48	45.5	64.0	17.0	124.5	97.0	70	5020.090.248	5



# Kunststoff Schlauchverschraubung Bogen 90° konisch dichtend

## Synthetic conduit connector 90° bend, conically sealing

### Anschlussgewinde metrisch | Entry thread metric

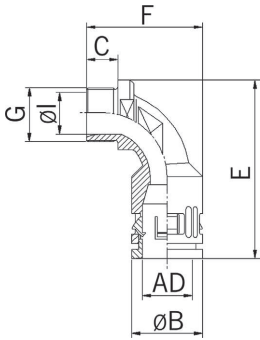

Material: Polyamid schlagfest  
 Dichtung: Schlauchanschluss konisch dichtend  
 Brandklasse: V0 (UL 94)  
 Eigenschaften: Schnelle und ausreissfeste Montage durch «push-in»-Verschluss, einfache Demontage durch Andrücken der Rasthülse  
 Schutzart: IP 66  
 Einsatztemperatur: -40°C / +120°C

Material: Polyamide impact-resistant  
 Seal: Conically sealing connection  
 Fire classification: V0 (UL 94)  
 Properties: Quick and pull-out-proof installation by means of the «push-in» lock, simple dismantling by displacing the snap-in sleeve  
 Protection class: IP 66  
 Temperature range: -40°C / +120°C



Quick-Verschraubung RQB1 90-M  
Schwarz

Quick connector RQB1 90-M  
Black

AD mm	G	øI mm	øB mm	C mm	E mm	F mm	Ø mm	Art.-Nr.   Art. No.	
10.0	M12x1.5	6.5	17.0	10.0	57.0	39.0	18	5104.010.212	50
13.0	M16x1.5	8.5	20.0	12.0	59.0	40.5	21	5104.013.216	50
15.8	M20x1.5	10.0	23.0	12.0	62.0	44.5	24	5104.015.220	50
21.2	M20x1.5	13.0	29.5	13.0	73.0	48.0	26	5104.021.220	50
21.2	M25x1.5	14.5	29.5	13.0	73.0	48.0	26	5104.021.225	50
28.5	M25x1.5	17.0	37.0	14.0	85.0	64.0	32	5104.028.225	25
28.5	M32x1.5	20.0	37.0	14.0	85.0	64.0	36	5104.028.232	25
34.5	M32x1.5	23.0	44.0	14.0	100.5	74.0	39	5104.034.232	10
34.5	M40x1.5	29.0	44.0	14.0	100.5	74.0	45	5104.034.240	10
42.5	M40x1.5	31.5	52.0	17.0	111.0	82.5	48	5104.042.240	10
42.5	M50x1.5	36.0	52.0	17.0	111.0	82.5	59	5104.042.250	10
54.5	M50x1.5	35.5	64.0	17.0	124.5	97.0	60	5104.054.250	5
54.5	M63x1.5	45.5	64.0	17.0	124.5	97.0	70	5104.054.263	5



Quick-Verschraubung RQB1 90-M  
Grau

Quick connector RQB1 90-M  
Grey

AD mm	G	øI mm	øB mm	C mm	E mm	F mm	Ø mm	Art.-Nr.   Art. No.	
10.0	M12x1.5	6.5	17.0	10.0	57.0	39.0	18	5104.010.012	50
13.0	M16x1.5	8.5	20.0	12.0	59.0	40.5	21	5104.013.016	50
15.8	M20x1.5	10.0	23.0	12.0	62.0	44.5	24	5104.015.020	50
21.2	M20x1.5	13.0	29.5	13.0	73.0	48.0	26	5104.021.020	50
21.2	M25x1.5	14.5	29.5	13.0	73.0	48.0	26	5104.021.025	50
28.5	M25x1.5	17.0	37.0	14.0	85.0	64.0	32	5104.028.025	25
28.5	M32x1.5	20.0	37.0	14.0	85.0	64.0	36	5104.028.032	25
34.5	M32x1.5	23.0	44.0	14.0	100.5	74.0	39	5104.034.032	10
34.5	M40x1.5	29.0	44.0	14.0	100.5	74.0	45	5104.034.040	10
42.5	M50x1.5	36.0	52.0	17.0	111.0	82.5	59	5104.042.050	10
54.5	M50x1.5	35.5	64.0	17.0	124.5	97.0	60	5104.054.050	5
54.5	M63x1.5	45.5	64.0	17.0	124.5	97.0	70	5104.054.063	5



# Kunststoff Schlauchverschraubung Bogen 90° mit Messing Anschlussgewinde

## Synthetic conduit connector 90° bend with nickel-plated brass entry thread

### Anschlussgewinde metrisch | Entry thread metric

Material: Flexamid V0 (HL 3)  
 Gewinde: Messing vernickelt  
 Dichtung: TPE  
 Brandklasse: V0 (UL 94)  
 Eigenschaften: Schnelle und ausreissfeste Montage durch «push-in»-Verschluss, einfache Demontage durch Andrücken der Rasthülse  
 Schutzart: IP 68 / IP 69  
 Einsatztemperatur: -40°C / +120°C

Material: Flexamide V0 (HL 3)  
 Entry thread: Nickel-plated brass  
 Seal: TPE  
 Fire classification: V0 (UL 94)  
 Properties: Quick and pull-out-proof installation by means of the «push-in» lock, simple dismounting by displacing the snap-in sleeve  
 Protection class: IP 68 / IP 69  
 Temperature range: -40°C / +120°C

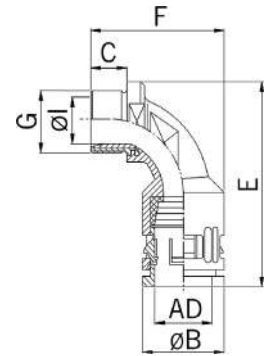

Quick-Verschraubung RQBK90-M  
 Schwarz

Quick connector RQBK90-M  
 Black

AD mm	G	ØI mm	ØB mm	C mm	E mm	F mm	h <sub>tr</sub> mm	Art.-Nr.   Art. No.	
10.0	M12x1.5	6.5	17.0	10.0	57.0	39.0	18	5105.010.212	50
13.0	M16x1.5	8.5	20.0	12.0	59.0	40.5	21	5105.013.216	50
15.8	M20x1.5	10.0	23.0	12.0	62.0	44.5	24	5105.015.220	50
21.2	M20x1.5	13.0	29.5	12.0	73.0	48.0	26	5105.021.220	50
21.2	M25x1.5	14.5	29.5	12.0	73.0	48.0	26	5105.021.225	50
28.5	M25x1.5	17.0	37.0	13.0	90.0	64.0	32	5105.028.225	25
28.5	M32x1.5	20.0	37.0	13.0	90.0	64.0	36	5105.028.232	25
34.5	M40x1.5	29.0	44.0	14.0	100.5	74.0	45	5105.034.240	10
34.5	M32x1.5	23.0	44.0	14.0	100.5	74.0	39	5105.034.232	10
42.5	M40x1.5	31.5	52.0	17.0	111.0	82.5	48	5105.042.240	10
42.5	M50x1.5	36.0	52.0	17.0	111.0	82.5	59	5105.042.250	10
54.5	M50x1.5	35.5	64.0	17.0	124.5	98.0	60	5105.054.250	5
54.5	M63x1.5	45.5	64.0	17.0	124.5	98.0	60	5105.054.263	5

Auf Anfrage lieferbar:

Available on request:

Ausführungen mit NPT Gewinde

Executions with NPT entry thread



### Anschlussgewinde Pg | Entry thread Pg



Quick-Verschraubung RQBK90-P  
 Schwarz

Quick connector RQBK90-P  
 Black

AD mm	G	ØI mm	ØB mm	C mm	E mm	F mm	h <sub>tr</sub> mm	Art.-Nr.   Art. No.	
10.0	Pg 7	6.5	17.0	10.0	57.0	39.0	18	5020.088.207	50
13.0	Pg 9	8.5	20.0	12.0	59.5	40.5	21	5020.088.209	50
15.8	Pg 11	10.0	23.0	12.0	62.0	44.5	24	5020.088.211	50
18.5	Pg 13	12.5	25.0	12.0	64.0	47.0	27	5020.088.213	50
21.2	Pg 16	14.5	29.5	13.0	73.0	48.0	26	5020.088.216	50
28.5	Pg 21	20.0	37.0	14.0	85.0	64.0	36	5020.088.221	25
34.5	Pg 29	29.0	44.0	14.0	100.5	74.0	46	5020.088.229	10
42.5	Pg 36	36.0	52.0	17.0	111.0	82.5	58	5020.088.236	10
54.5	Pg 48	45.5	64.0	17.0	124.5	97.0	70	5020.088.248	5



# Kunststoff Schlauchverschraubung Bogen 90° mit Messing Anschlussgewinde drehbar

## Synthetic conduit connector 90° bend with turnable nickel-plated brass entry thread

### Anschlussgewinde metrisch | Entry thread metric

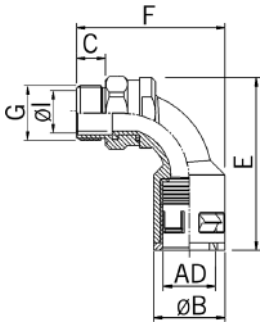

Material: Flexamid V0 (HL 3)  
 Gewinde: Messing vernickelt  
 Dichtung: TPE  
 Brandklasse: V0 (UL 94)  
 Eigenschaften: Schnelle und ausreissfeste Montage durch den «push-in»-Verschluss, einfache Demontage durch Andrücken der Rasthülse Halogenfrei  
 Adapter: Gewindeanschluss drehbar  
 Schutzart: IP 68 / IP 69  
 Einsatztemperatur: -40°C / +120°C

Material: Flexamide V0 (HL 3)  
 Entry thread: Nickel-plated brass  
 Seal: TPE  
 Fire classification: V0 (UL 94)  
 Properties: Quick and pull-out-proof installation by means of the «push-in» lock, simple dismounting by displacing the snap-in sleeve Halogen-free  
 Adapter: Turnable thread connection  
 Protection class: IP 68 / IP 69  
 Temperature range: -40°C / +120°C



Quick-Verschraubung RQBK90DR-M Schwarz								Quick connector RQBK90DR-M Black		
AD mm	G	ØI mm	ØB mm	C mm	E mm	F mm	mm	Art.-Nr.   Art. No.		
21.2	M20x1.5	13.0	29.5	12	72	62	27	5121.021.220	50	
28.5	M25x1.5	17.0	37.0	13	90	80	34	5121.028.225	25	
34.5	M32x1.5	24.5	44.0	14	100	91	43	5121.034.232	10	
42.5	M40x1.5	31.5	52.0	17	111	103	52	5121.042.240	10	

Auf Anfrage lieferbar: Ausführungen mit Pg Gewinde  
 Available on request: Executions with Pg entry thread

### Bogen 45° Anschlussgewinde metrisch | 45° bend entry thread metric

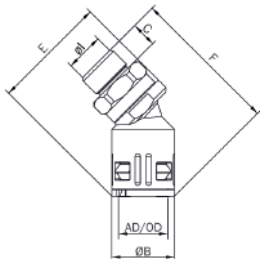

Material: Flexamid V0 (HL 3)  
 Gewinde: Messing vernickelt  
 Dichtung: TPE  
 Brandklasse: V0 (UL 94)  
 Eigenschaften: Schnelle und ausreissfeste Montage durch den «push-in»-Verschluss, einfache Demontage durch Andrücken der Rasthülse Halogenfrei  
 Adapter: Gewindeanschluss drehbar  
 Schutzart: IP 68 / IP 69  
 Einsatztemperatur: -40°C / +120°C

Material: Flexamide V0 (HL 3)  
 Entry thread: Nickel-plated brass  
 Seal: TPE  
 Fire classification: V0 (UL 94)  
 Properties: Quick and pull-out-proof installation by means of the «push-in» lock, simple dismounting by displacing the snap-in sleeve Halogen-free  
 Adapter: Turnable thread connection  
 Protection class: IP 68 / IP 69  
 Temperature range: -40°C / +120°C



Kunststoff-Verschraubung Bogen 45° RQBK45DR								Synthetic connector 45° bend RQBK45DR		
AD mm	G	ØI mm	ØB mm	C mm	E mm	F mm	mm	Art.-Nr.   Art. No.		
21.2	M20x1.5	13.0	29.5	12	72	62	27	5131.021.220	50	
28.5	M25x1.5	17.0	37.0	12	72	90	34	5131.028.225	25	
34.5	M32x1.5	24.5	44.0	14	100	91	43	5131.034.232	10	
42.5	M40x1.5	31.5	52.0	17	111	103	52	5131.042.240	10	

Auf Anfrage lieferbar: Ausführungen mit Pg Gewinde  
 Available on request: Executions with Pg entry thread

# Kunststoff Schlauchverschraubung Bogen 45°

## Synthetic conduit connector 45° bend

### Anschlussgewinde metrisch | Entry thread metric

Material: Polyamid schlagfest  
 Dichtung: TPE  
 Brandklasse: V0 (UL 94)  
 Eigenschaften: Schnelle und ausreissfeste Montage durch «push-in»-Verschluss, einfache Demontage durch Andrücken der Rasthülse  
 Schutzart: IP 68 / IP 69  
 Einsatztemperatur: -40°C / +120°C

Material: Polyamide impact-resistant  
 Seal: TPE  
 Fire classification: V0 (UL 94)  
 Properties: Quick and pull-out-proof installation by means of the «push-in» lock, simple dismounting by displacing the snap-in sleeve  
 Protection class: IP 68 / IP 69  
 Temperature range: -40°C / +120°C

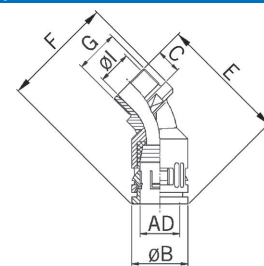

Quick-Verschraubung RQB45-M  
Schwarz

Quick connector RQB45-M  
Black

AD mm	G	ØI mm	ØB mm	C mm	E mm	F mm	Ø mm	Art.-Nr.   Art. No.	
10.0	M12x1.5	6.5	17.0	10.0	39.0	45.0	18	5100.010.212	50
13.0	M16x1.5	8.5	20.0	12.0	42.5	48.0	21	5100.013.216	50
15.8	M20x1.5	10.0	23.0	12.0	44.5	52.5	24	5100.015.220	50
21.2	M20x1.5	13.0	29.5	13.0	55.0	60.0	26	5100.021.220	50
21.2	M25x1.5	14.5	29.5	14.0	56.0	60.0	26	5100.021.225	50
28.5	M25x1.5	17.0	37.0	14.0	64.0	72.0	32	5100.028.225	25
28.5	M32x1.5	20.0	37.0	14.0	64.0	75.0	36	5100.028.232	25
34.5	M32x1.5	23.0	44.0	14.0	73.5	76.0	39	5100.034.232	10
34.5	M40x1.5	29.0	44.0	14.0	73.5	77.0	45	5100.034.240	10
42.5	M40x1.5	31.5	52.0	17.0	82.5	86.0	48	5100.042.240	10
42.5	M50x1.5	36.0	52.0	17.0	82.5	86.0	58	5100.042.250	10
54.5	M50x1.5	35.5	64.0	17.0	92.0	95.0	58	5100.054.250	5
54.5	M63x1.5	45.5	64.0	17.0	97.0	100.0	69	5100.054.263	5

Auf Anfrage lieferbar:

Available on request:

Ausführungen mit NPT Gewinde

Executions with NPT entry thread



Quick-Verschraubung RQB45-M  
Grau

Quick connector RQB45-M  
Grey

AD mm	G	ØI mm	ØB mm	C mm	E mm	F mm	Ø mm	Art.-Nr.   Art. No.	
15.8	M20x1.5	10.0	23.0	12.0	44.5	52.5	24	5100.015.020	50
21.2	M20x1.5	13.0	29.5	13.0	55.0	60.0	26	5100.021.020	50
21.2	M25x1.5	14.5	29.5	14.0	56.0	60.0	26	5100.021.025	50
28.5	M32x1.5	20.0	37.0	14.0	64.0	75.0	36	5100.028.032	25
34.5	M40x1.5	29.0	44.0	14.0	73.5	77.0	45	5100.034.040	10
42.5	M40x1.5	31.5	52.0	17.0	82.5	86.0	48	5100.042.040	10
42.5	M50x1.5	36.0	52.0	17.0	82.5	86.0	58	5100.042.050	10
54.5	M63x1.5	45.5	64.0	17.0	97.0	100.0	69	5100.054.063	5



### Anschlussgewinde Pg | Entry thread Pg



Quick-Verschraubung RQB45-P  
Schwarz

Quick connector RQB45-P  
Black

AD mm	G	ØI mm	ØB mm	C mm	E mm	F mm	Ø mm	Art.-Nr.   Art. No.	
10.0	Pg 7	6.5	17.0	10.0	39.0	45.0	18	5020.089.207	50
13.0	Pg 9	8.5	20.0	12.0	42.5	48.0	21	5020.089.209	50
15.8	Pg 11	10.0	23.0	12.0	44.5	52.5	24	5020.089.211	50
18.5	Pg 13	12.5	25.0	12.0	49.0	59.0	27	5020.089.213	50
21.2	Pg 16	14.5	29.5	13.0	56.0	60.0	26	5020.089.216	50
28.5	Pg 21	20.0	37.0	14.0	64.0	75.0	36	5020.089.221	25
34.5	Pg 29	29.0	44.0	14.0	73.5	77.0	45	5020.089.229	10
42.5	Pg 36	36.0	52.0	17.0	82.5	86.0	58	5020.089.236	10
54.5	Pg 48	45.5	64.0	17.0	97.0	100.0	70	5020.089.248	5



# Kunststoff Schlauchverschraubung Bogen 45° konisch dichtend

## Synthetic conduit connector 45° bend conically sealing

### Anschlussgewinde metrisch | Entry thread metric

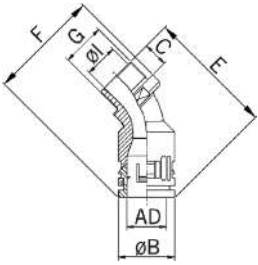

Material: Polyamid schlagfest  
 Dichtung: Schlauchanschluss konisch dichtend  
 Brandklasse: V0 (UL 94)  
 Eigenschaften: Schnelle und ausreissfeste Montage durch «push-in»-Verschluss, einfache Demontage durch Andrücken der Rasthülse  
 Schutzart: IP 66  
 Einsatztemperatur: -40°C / +120°C

Material: Polyamide impact-resistant  
 Seal: Conically sealing connection  
 Fire classification: V0 (UL 94)  
 Properties: Quick and pull-out-proof installation by means of the «push-in» lock, simple dismounting by displacing the snap-in sleeve  
 Protection class: IP 66  
 Temperature range: -40°C / +120°C



Quick-Verschraubung RQB1 45-M  
Schwarz

Quick connector RQB1 45-M  
Black

AD mm	G	ØI mm	ØB mm	C mm	E mm	F mm	Ø <sub>sr</sub> mm	Art.-Nr.   Art. No.	
10.0	M12x1.5	6.5	17.0	10.0	39.0	45.0	18	5101.010.212	50
13.0	M16x1.5	8.5	20.0	12.0	42.5	48.0	21	5101.013.216	50
15.8	M20x1.5	10.0	23.0	12.0	44.5	52.5	24	5101.015.220	50
21.2	M20x1.5	13.0	29.5	13.0	55.0	60.0	26	5101.021.220	50
21.2	M25x1.5	14.5	29.5	14.0	56.0	60.0	26	5101.021.225	50
28.5	M25x1.5	17.0	37.0	14.0	64.0	72.0	32	5101.028.225	50
28.5	M32x1.5	20.0	37.0	14.0	64.0	75.0	36	5101.028.232	25
34.5	M32x1.5	23.0	44.0	14.0	73.5	76.0	39	5101.034.232	10
34.5	M40x1.5	29.0	44.0	14.0	73.5	77.0	45	5101.034.240	10
42.5	M40x1.5	31.5	52.0	17.0	82.5	86.0	48	5101.042.240	10
42.5	M50x1.5	36.0	52.0	17.0	82.5	86.0	58	5101.042.250	10
54.5	M50x1.5	35.5	64.0	17.0	92.0	95.0	58	5101.054.250	5
54.5	M63x1.5	45.5	64.0	17.0	97.0	100.0	69	5101.054.263	5



Quick-Verschraubung RQB1 45-M  
Grau

Quick connector RQB1 45-M  
Grey

AD mm	G	ØI mm	ØB mm	C mm	E mm	F mm	Ø <sub>sr</sub> mm	Art.-Nr.   Art. No.	
10.0	M12x1.5	6.5	17.0	10.0	39.0	45.0	18	5101.010.012	50
13.0	M16x1.5	8.5	20.0	12.0	42.5	48.0	21	5101.013.016	50
15.8	M20x1.5	10.0	23.0	12.0	44.5	52.5	24	5101.015.020	50
21.2	M20x1.5	13.0	29.5	12.0	55.0	60.0	26	5101.021.020	50
21.2	M25x1.5	14.5	29.5	13.0	56.0	60.0	26	5101.021.025	50
28.5	M25x1.5	17.0	37.0	13.0	64.0	72.0	32	5101.028.025	25
28.5	M32x1.5	20.0	37.0	14.0	64.0	75.0	36	5101.028.032	25
34.5	M32x1.5	23.0	44.0	14.0	73.5	76.0	39	5101.034.032	10
34.5	M40x1.5	29.0	44.0	14.0	73.5	77.0	45	5101.034.040	10
42.5	M40x1.5	31.5	52.0	17.0	82.5	86.0	48	5101.042.040	10
42.5	M50x1.5	36.0	52.0	17.0	82.5	86.0	58	5101.042.050	10
54.5	M50x1.5	35.5	64.0	17.0	92.0	95.0	58	5101.054.050	5
54.5	M63x1.5	45.5	64.0	17.0	97.0	100.0	69	5101.054.063	5

# Kunststoff Schlauchverschraubung Bogen 45° mit Messing Anschlussgewinde

## Synthetic conduit connector 45° bend with nickel-plated brass entry thread

### Anschlussgewinde metrisch | Entry thread metric

Material: Flexamid V0 (HL 3)  
 Gewinde: Messing vernickelt  
 Dichtung: TPE  
 Brandklasse: V0 (UL 94)  
 Eigenschaften: Schnelle und ausreissfeste Montage durch «push-in»-Verschluss, einfache Demontage durch Andrücken der Rasthülse  
 Schutzart: IP 68 / IP 69  
 Einsatztemperatur: -40°C / +120°C

Material: Flexamide V0 (HL 3)  
 Entry thread: Nickel-plated brass  
 Seal: TPE  
 Fire classification: V0 (UL 94)  
 Properties: Quick and pull-out-proof installation by means of the «push-in» lock, simple dismounting by displacing the snap-in sleeve  
 Protection class: IP 68 / IP 69  
 Temperature range: -40°C / +120°C

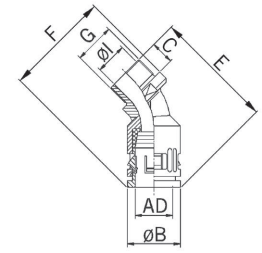

Quick-Verschraubung RQBK45-M  
Schwarz

Quick connector RQBK45-M  
Black

AD mm	G	ØI mm	ØB mm	C mm	E mm	F mm	Ø <sub>tr</sub> mm	Art.-Nr.   Art. No.	
10.0	M12x1.5	6.5	17.0	10.0	39.0	45.0	18	5102.010.212	50
13.0	M16x1.5	8.5	20.0	12.0	42.5	48.0	21	5102.013.216	50
15.8	M20x1.5	10.0	23.0	12.0	44.5	52.5	24	5102.015.220	50
21.2	M20x1.5	13.0	29.5	12.0	55.0	60.0	26	5102.021.220	50
21.2	M25x1.5	14.5	29.5	13.0	56.0	60.0	26	5102.021.225	50
28.5	M25x1.5	17.0	37.0	13.0	64.0	72.0	32	5102.028.225	25
28.5	M32x1.5	20.0	37.0	14.0	64.0	75.0	37	5102.028.232	25
34.5	M32x1.5	23.0	44.0	14.0	73.5	76.0	39	5102.034.232	10
34.5	M40x1.5	29.0	44.0	14.0	73.5	77.0	46	5102.034.240	10
42.5	M40x1.5	31.5	52.0	17.0	82.5	86.0	48	5102.042.240	10
42.5	M50x1.5	36.0	52.0	17.0	82.5	86.0	59	5102.042.250	10
54.5	M50x1.5	35.5	64.0	17.0	92.0	95.0	59	5102.054.250	5
54.5	M63x1.5	45.5	64.0	17.0	97.0	100.0	69	5102.054.263	5



### Anschlussgewinde Pg | Entry thread Pg



Quick-Verschraubung RQBK45-P  
Schwarz

Quick connector RQBK45-P  
Black

AD mm	G	ØI mm	ØB mm	C mm	E mm	F mm	Ø <sub>tr</sub> mm	Art.-Nr.   Art. No.	
10.0	Pg 7	6.5	17.0	10.0	39.0	45.0	18	5020.087.207	50
13.0	Pg 9	8.5	20.0	12.0	42.5	48.0	21	5020.087.209	50
15.8	Pg 11	10.0	23.0	12.0	44.5	52.5	24	5020.087.211	50
18.5	Pg 13	12.5	25.0	12.0	49.0	59.0	27	5020.087.213	50
21.2	Pg 16	14.5	29.5	13.0	56.0	60.0	26	5020.087.216	50
28.5	Pg 21	20.0	37.0	14.0	64.0	75.0	36	5020.087.221	25
34.5	Pg 29	29.0	44.0	14.0	73.5	77.0	45	5020.087.229	10
42.5	Pg 36	36.0	52.0	17.0	82.5	86.0	58	5020.087.236	10
54.5	Pg 48	45.5	64.0	17.0	97.0	100.0	70	5020.087.248	5





# Anschlussflansch für Schlauchverschraubungen

## Connecting flange for conduit connectors

### Anschlussgewinde metrisch | Entry thread metric

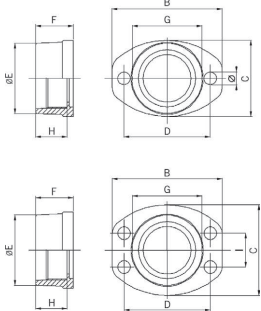

Material: Hochwertiges Polyamid  
 Brandklasse: V0 (UL 94)  
 Einsatzbereich: Für Verschraubungen mit metrischem Anschlussgewinde  
 Schutzart: IP 68  
 Einsatztemperatur: -40°C / +120°C

Material: High quality polyamide  
 Fire classification: V0 (UL 94)  
 Application: Suitable for all metric conduit connectors  
 Protection class: IP 68  
 Temperature range: -40°C / +120°C



Quick-Verschraubung RQF2-M  
Schwarz

Quick connector RQF2-M  
Black

G	AD mm	B/C mm	D mm	Ø mm	ØE mm	H mm	F mm	I mm	Art.-Nr.   Art. No.	
<b>M25x1.5</b>	21.2/28.5	46/32	36.0	5.4	29.5	13.0	15.5	-	<b>5020.071.225</b>	50
<b>M32x1.5</b>	28.5/34.5	63/46	52.0	6.6	37.0	16.5	19.0	-	<b>5020.071.232</b>	25
<b>M40x1.5</b>	34.5/42.5	67/55	54.0	6.6	45.0	16.0	18.5	36.0	<b>5020.071.240</b>	10
<b>M50x1.5</b>	42.5/54.5	86/64	73.0	6.6	55.0	17.0	20.0	30.0	<b>5020.071.250</b>	10
<b>M63x1.5</b>	54.5	86/70	73.0	6.6	68.0	17.0	20.0	30.0	<b>5020.071.263</b>	5



Quick-Verschraubung RQF2-M  
Grau

Quick connector RQF2-M  
Grey

G	AD mm	B/C mm	D mm	Ø mm	ØE mm	H mm	F mm	I mm	Art.-Nr.   Art. No.	
<b>M25x1.5</b>	21.2/28.5	46/32	36.0	5.4	29.5	13.0	15.5	-	<b>5020.071.025</b>	50
<b>M32x1.5</b>	28.5/34.5	63/46	52.0	6.6	37.0	16.5	19.0	-	<b>5020.071.032</b>	25
<b>M40x1.5</b>	34.5/42.5	67/55	54.0	6.6	45.0	16.0	18.5	36.0	<b>5020.071.040</b>	10
<b>M50x1.5</b>	42.5/54.5	86/64	73.0	6.6	55.0	17.0	20.0	30.0	<b>5020.071.050</b>	10
<b>M63x1.5</b>	54.5	86/70	73.0	6.6	68.0	17.0	20.0	30.0	<b>5020.071.063</b>	5

### Befestigungswinkel aus Metall | Fastening angle metal

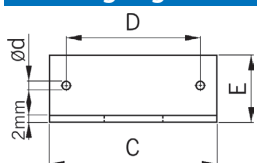

Material: Stahl chromatiert  
 Einsatzbereich: Winkelblech mit Durchgangsbohrung und zwei Befestigungslöcher  
 Einsatztemperatur: -40°C / +200°C

Material: Chromated steel  
 Application: Angular sheet steel with transitory hole and two fixing holes  
 Temperature range: -40°C / +200°C

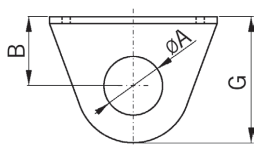

Für Verschraubungen mit metrischem Anschlussgewinde

Suitable for all metric conduit connectors

ØA mm	G	B mm	G mm	C mm	D mm	E mm	Ød mm	Art.-Nr.   Art. No.	
<b>17</b>	M16	22	38.0	50	40	20	4.5	<b>5010.031.016</b>	1
<b>21</b>	M20	22	38.0	50	40	20	4.5	<b>5010.031.020</b>	1
<b>26</b>	M25	27	46.9	60	50	20	4.5	<b>5010.031.025</b>	1
<b>33</b>	M32	32	56.9	70	60	20	4.5	<b>5010.031.032</b>	1
<b>41</b>	M40	37	67.0	80	70	20	4.5	<b>5010.031.040</b>	1
<b>51</b>	M50	40	78.4	90	80	20	4.5	<b>5010.031.050</b>	1
<b>64</b>	M63	42	83.0	90	80	20	4.5	<b>5010.031.063</b>	1

### Befestigungswinkel aus Kunststoff | Synthetic fastening angles

Material: Polypropylen schlagfest  
 Einsatzbereich: Universal-Verschraubungshalter für Schlauch- und Kabelverschraubungen  
 Einsatztemperatur: -40°C / +100°C

Material: Polypropylene impact-resistant  
 Application: Universal holder for cable glands and conduit screw connectors  
 Temperature range: -40°C / +100°C

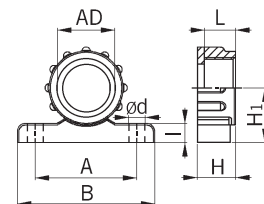

Anschlussgewinde metrisch Grau				Entry thread metric Grey				Art.-Nr.   Art. No.	
G	L mm	A mm	B mm	ød mm	H1 mm	H mm	I mm		
M20x1.5	11.5	37.5	50	5.7	20.0	13.5	7.0	0315.001.020	50
M25x1.5	11.5	37.5	57	5.7	25.0	13.5	8.0	0315.001.025	50
M32x1.5	14.0	53.5	67	6.7	27.5	16.5	8.0	0315.001.032	50
M40x1.5	14.0	65.5	79	6.7	33.0	16.5	8.5	0315.001.040	50
M50x1.5	15.0	69.5	86	6.7	36.0	17.5	9.5	0315.001.050	50



Anschlussgewinde Pg Grau				Entry thread Pg Grey				Art.-Nr.   Art. No.	
G	L mm	A mm	B mm	ød mm	H1 mm	H mm	I mm		
Pg 9	11.5	29	40	5.7	14.5	14.0	6.0	0315.000.009	50
Pg 11	11.5	37	50	5.7	20.0	14.0	7.0	0315.000.011	50
Pg 13	11.5	37	50	5.7	20.0	14.0	7.0	0315.000.013	50
Pg 16	11.5	37	50	5.7	20.0	14.0	7.0	0315.000.016	50
Pg 21	11.5	43	57	5.7	25.0	14.0	8.0	0315.000.021	50
Pg 29	14.0	53	67	6.7	27.5	16.5	8.0	0315.000.029	25
Pg 36	14.0	65	80	6.7	33.0	16.5	8.5	0315.000.036	25
Pg 48	16.0	76	93	6.7	38.5	19.0	10.0	0315.000.048	25



# Kunststoff Schlauchverschraubungen Verteiler-Kupplungen

## Synthetic conduit connector distributor couplings

### Kunststoff Schlauchverschraubung T-Verteiler | Synthetic conduit connector T-distributor

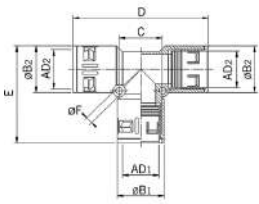

Material: Flexamid V0 (HL 3)  
 Dichtung: TPE  
 Brandklasse: V0 (UL 94)  
 Eigenschaften: Schnelle und ausreissfeste Montage durch «push-in»-Verschluss, einfache Demontage durch Andrücken der Rasthülse  
 Schutzart: IP 68 / IP 69  
 Einsatztemperatur: -40°C / +120°C

Material: Flexamide V0 (HL 3)  
 Seal: TPE  
 Fire classification: V0 (UL 94)  
 Properties: Quick and pull-out-proof installation by means of the «push-in» lock, simple dismounting by displacing the snap-in sleeve  
 Protection class: IP 68 / IP 69  
 Temperature range: -40°C / +120°C



Quick-Verschraubung RQT-PA  
 Schwarz

Quick connector RQT-PA  
 Black

AD1 mm	AD2 mm	ØB1 mm	ØB2 mm	C mm	D mm	E mm	ØF mm	Art.-Nr.   Art. No.	
21.2	21.2	29.4	29.4	27.0	93.5	66.0	2x6.5	5020.041.201	10
28.5	28.5	37.0	37.0	34.0	107.0	78.0	2x6.5	5020.041.202	10
34.5	28.5	44.0	37.0	38.0	113.0	83.0	2x6.5	5020.041.210	10
34.5	34.5	44.0	44.0	40.0	119.0	90.5	2x6.5	5020.041.211	10
42.5	42.5	52.0	52.0	45.0	138.0	94.5	2x6.5	5020.041.212	10
54.5	54.5	64.0	64.0	56.5	146.0	105.0	2x6.5	5020.041.213	10

Auf Anfrage lieferbar:

Available on request:

Ausführung in Grau

Executions in grey

### Kunststoff Schlauchverschraubung Y-Verteiler | Synthetic conduit connector Y-distributor



Quick-Verschraubung RQY-PA  
 Schwarz  
 zu ROHRflex® Wellenschlauch

Quick connector RQY-PA  
 Black  
 for ROHRflex® corrugated conduit

AD1 mm	AD2 mm	ØB1 mm	ØB2 mm	C mm	D mm	E mm	ØF mm	Art.-Nr.   Art. No.	
15.8	13.0	23	20	42	71	28	2x5.5	5020.032.203	10
21.2	15.8	29	23	51	87	27	2x6.5	5020.032.206	10
28.5	21.2	37	30	63	99	37	2x6.5	5020.032.208	10
34.5	28.5	44	37	77	106	43	2x6.5	5020.032.209	10
42.5	34.5	52	44	98	125	45	2x6.5	5020.032.210	10
54.5	42.5	64	52	110	129	62	2x6.5	5020.032.211	5

Auf Anfrage lieferbar:

Available on request:

Ausführung in Grau

Executions in grey

# Kunststoff Schlauchverschraubungen Verteiler-Kupplungen

## Synthetic conduit connector distributor couplings

### Kunststoff Schlauchverschraubung Y-Verteiler | Synthetic conduit connector Y-distributor

Material: TPE  
 Brandklasse: V0 (UL 94)  
 Eigenschaften: Für schnelle Schlauchmontage durch einfaches Aufstecken  
 Schutzart: IP 66  
 Einsatztemperatur: -40°C / +120°C

Material: TPE  
 Fire classification: V0 (UL 94)  
 Properties: For quick conduit assembly by simply plugging  
 Protection class: IP 66  
 Temperature range: -40°C / +120°C

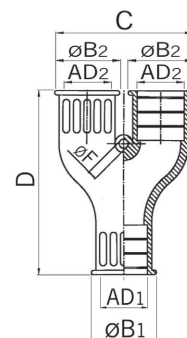

Kunststoff Y-Verteiler RQY-TPE Schwarz					Y-distributor RQY-TPE Black			Art.-Nr.   Art. No.	
AD1 mm	AD2 mm	ØB1 mm	ØB2 mm	D mm	C mm	ØF mm			
10.0	2x10.0	17.5	17.5	54.5	36.5	4.0	5020.033.205	10	
21.2	2x15.8	29.5	25.0	75.0	52.0	4.0	5020.033.206	10	
21.2	2x21.2	29.5	29.5	82.5	62.5	4.0	5020.033.207	10	
28.5	2x15.8	36.5	25.0	75.0	52.0	4.0	5020.033.213	10	
28.5	2x21.2	36.5	29.5	81.5	60.5	4.0	5020.033.208	10	
34.5	2x28.5	42.5	36.5	86.0	77.0	4.0	5020.033.209	10	



### Reduzierung | Reduction fitting

Material: Flexamid V0 (HL 3)  
 Dichtung: TPE  
 Brandklasse: V0 (UL 94)  
 Eigenschaften: Schnelle und ausreissfeste Montage durch «push-in»-Verschluss, einfache Demontage durch Andrücken der Rasthülse  
 Schutzart: IP 68 / IP 69  
 Einsatztemperatur: -40°C / +120°C

Material: Flexamide V0 (HL 3)  
 Seal: TPE  
 Fire classification: V0 (UL 94)  
 Properties: Quick and pull-out-proof installation by means of the «push-in» lock, simple dismantling by displacing the snap-in sleeve  
 Protection class: IP 68 / IP 69  
 Temperature range: -40°C / +120°C

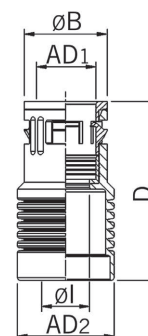

Quick-Verschraubung RQGR Schwarz					Quick connector RQGR Black			Art.-Nr.   Art. No.	
AD1 mm	AD2 mm	ØB mm	ØI mm	D mm					
15.8	21.2	23.0	12.5	60.5			5601.015.221	10	
15.8	28.5	23.0	12.5	63.0			5601.015.228	10	
15.8	34.5	23.0	12.5	60.0			5601.015.234	10	
21.2	28.5	29.5	17.0	65.0			5601.021.228	10	
21.2	34.5	29.5	17.0	64.0			5601.021.234	10	
21.2	54.5	29.5	17.0	86.0			5601.021.254	5	
28.5	34.5	37.0	23.5	70.0			5601.028.234	10	
34.5	42.5	44.0	30.0	75.0			5601.034.242	10	
42.5	54.5	52.0	39.0	84.0			5601.042.254	5	



# Kunststoff Schlauchverschraubungen Schnellkupplung

## Synthetic conduit connector quick coupling

### Kupplung | Coupling

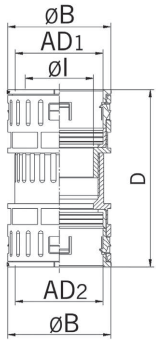

Material: Polyamid schlagfest  
 Dichtung: TPE  
 Brandklasse: V0 (UL 94)  
 Eigenschaften: Schnelle und ausreissfeste Montage durch «push-in»-Verschluss, einfache Demontage durch Andrücken der Rasthülse  
 Schutzart: IP 68 / IP 69  
 Einsatztemperatur: -40°C / +120°C

Material: Polyamide impact-resistant  
 Seal: TPE  
 Fire classification: V0 (UL 94)  
 Properties: Quick and pull-out-proof installation by means of the «push-in» lock, simple dismounting by displacing the snap-in sleeve  
 Protection class: IP 68 / IP 69  
 Temperature range: -40°C / +120°C



Quick-Verschraubung RQK-PA  
Schwarz

Quick connector RQK-PA  
Black

AD1 mm	AD2 mm	ØB mm	ØI mm	D mm	Art.-Nr.   Art. No.	
21.2	21.2	29.5	17.0	80.0	5602.021.221	10
28.5	28.5	37.0	23.5	86.5	5602.028.228	10
34.5	34.5	44.0	30.0	93.0	5602.034.234	10
42.5	42.5	63.0	36.5	144.0	5602.042.242	10
54.5	54.5	74.0	45.0	161.0	5602.054.254	10

### Kupplung | Coupling

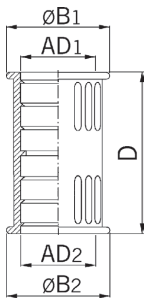

Material: TPE  
 Brandklasse: V0 (UL 94)  
 Eigenschaften: Rationelle Schlauchkupplung mit innen umlaufenden Rippen zur Fixierung auf dem Schlauch  
 Schutzart: IP 66  
 Einsatztemperatur: -40°C / +120°C

Material: TPE  
 Fire classification: V0 (UL 94)  
 Properties: Efficient tube coupling with inner ribs serving to fix it on the tube  
 Protection class: IP 66  
 Temperature range: -40°C / +120°C



Verbindungs- und Quickkupplung RQK  
Schwarz

Quick coupler RQK  
Black

AD1 mm	AD2 mm	ØB1 mm	ØB2 mm	D mm	Art.-Nr.   Art. No.	
10.0	10.0	17.5	17.5	33.5	5020.066.210	10
13.0	13.0	20.0	20.0	36.5	5020.066.207	10
15.8	15.8	23.0	23.0	44.5	5020.066.208	10
21.2	21.2	29.5	29.5	46.0	5020.066.201	10
28.5	28.5	36.5	36.5	46.0	5020.066.202	10
34.5	34.5	42.5	42.5	48.0	5020.066.203	10
42.5	42.5	51.0	51.0	60.0	5020.066.204	10
54.5	54.5	63.0	63.0	70.0	5020.066.205	10



Verbindungs- und Quickkupplung RQK  
Grau

Quick coupler RQK  
Grey

AD1 mm	AD2 mm	ØB1 mm	ØB2 mm	D mm	Art.-Nr.   Art. No.	
10.0	10.0	17.5	17.5	33.5	5020.066.010	10
13.0	13.0	20.0	20.0	36.5	5020.066.007	10
15.8	15.8	23.0	23.0	44.5	5020.066.008	10
18.5	18.5	26.5	26.5	48.0	5020.066.009	10
21.2	21.2	29.5	29.5	46.0	5020.066.001	10
28.5	28.5	36.5	36.5	46.0	5020.066.002	10
34.5	34.5	42.5	42.5	48.0	5020.066.003	10
42.5	42.5	51.0	51.0	60.0	5020.066.004	10
54.5	54.5	63.0	63.0	70.0	5020.066.005	10



## zu ROHRflex® Welschlauch | for ROHRflex® corrugated conduit

Material:	Polyamid	Material:	Polyamide
Brandklasse:	V0 (UL 94)	Fire classification:	V0 (UL 94)
Eigenschaften:	Zum Schutz des Kabels, aufsteckbar auf alle ROHRflex® Welschläuche	Properties:	For cable protection, attachable on all ROHRflex® corrugated conduits
Einsatztemperatur:	-40°C / +120°C	Temperature range:	-40°C / +120°C

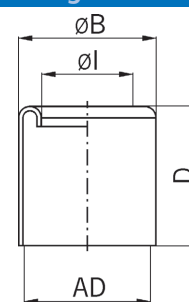

Endtülle Schwarz				End cap Black	
AD mm	ØI mm	ØB mm	D mm	Art.-Nr.   Art. No.	
13.0	7.8	15.0	20	5030.021.209	50
15.8	10.3	17.8	20	5030.021.211	50
21.2	14.3	23.2	21	5030.021.216	50
28.5	20.8	30.5	22	5030.021.221	25
34.5	26.8	36.5	22	5030.021.229	25
42.5	33.8	44.5	25	5030.021.236	25
54.5	45.8	56.5	25	5030.021.248	10



Endtülle Grau				End cap Grey	
AD mm	ØI mm	ØB mm	D mm	Art.-Nr.   Art. No.	
15.8	10.3	17.8	20	5030.021.011	50
21.2	14.3	23.2	21	5030.021.016	50
28.5	20.8	30.5	22	5030.021.021	25
34.5	26.8	36.5	22	5030.021.029	25



# Endtülle / Übergangstülle Schlauch zu Kabel

## End cap / transition sleeve from conduit to cable

zu ROHRflex® Welschlauch | for ROHRflex® corrugated conduit

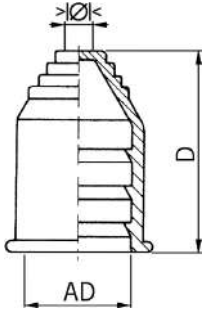

Material: TPE  
 Brandklasse: V0 (UL 94)  
 Eigenschaften: Schlauchendabschluss oder Kabelübergang mit innen umlaufenden Rippen zur Fixierung auf dem Schlauch  
 Schutzart: IP 65  
 Einsatztemperatur: -40°C / +120°C

Material: TPE  
 Fire classification: V0 (UL 94)  
 Properties: End cap or transition sleeve with inner ribs that fix it on the conduit  
 Protection class: IP 65  
 Temperature range: -40°C / +120°C









TPE-Übergangstülle RQE Schwarz			TPE transition sleeve RQE Black	
AD mm	>Ø< mm	D mm	Art.-Nr.   Art. No.	
10.0	1.0-8.0	29.0	5030.012.207	50
13.0	1.0-10.0	32.5	5030.012.209	50
15.8	4.0-12.0	36.5	5030.012.211	50
18.5	4.0-13.0	37.5	5030.012.213	50
21.2	6.0-16.5	37.5	5030.012.216	50
28.5	6.0-23.0	40.2	5030.012.221	25
34.5	6.0-29.0	44.2	5030.012.229	25
42.5	10.0-37.0	46.0	5030.012.236	25
54.5	10.0-47.0	52.0	5030.012.248	10

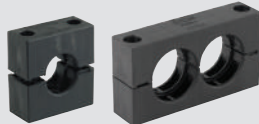

TPE-Übergangstülle RQE Grau			TPE transition sleeve RQE Grey	
AD mm	>Ø< mm	D mm	Art.-Nr.   Art. No.	
10.0	1.0-8.0	29.0	5030.012.007	50
13.0	1.0-10.0	32.5	5030.012.009	50
15.8	4.0-12.0	36.5	5030.012.011	50
18.5	4.0-13.0	37.5	5030.012.013	50
21.2	6.0-16.5	37.5	5030.012.016	50
28.5	6.0-23.0	40.2	5030.012.021	25
34.5	6.0-29.0	44.2	5030.012.029	25
42.5	10.0-37.0	46.0	5030.012.036	25
54.5	10.0-47.0	52.0	5030.012.048	10



Schlauchhalter RQS & RQH Conduit clamp RQS & RQH		1
Schlauchhalter kleine Bauform RQM Conduit clamp small size RQM		2
Massiv-Schlauchhalter RQM Conduit clamp heavy RQM		3
Scheuerschutz zu Kunststoff Schutzschlauch Abrasion protection for synthetic protective conduit		4
Reduzierungen zu Schlauchhalter RQM Reduction for conduit clamp RQM		5
Schlauch-Klemmschelle Clamping collar for conduit		6

# Schlauchhalter zu Kunststoff Schutzschlauch

## Conduit clamps for synthetic conduit

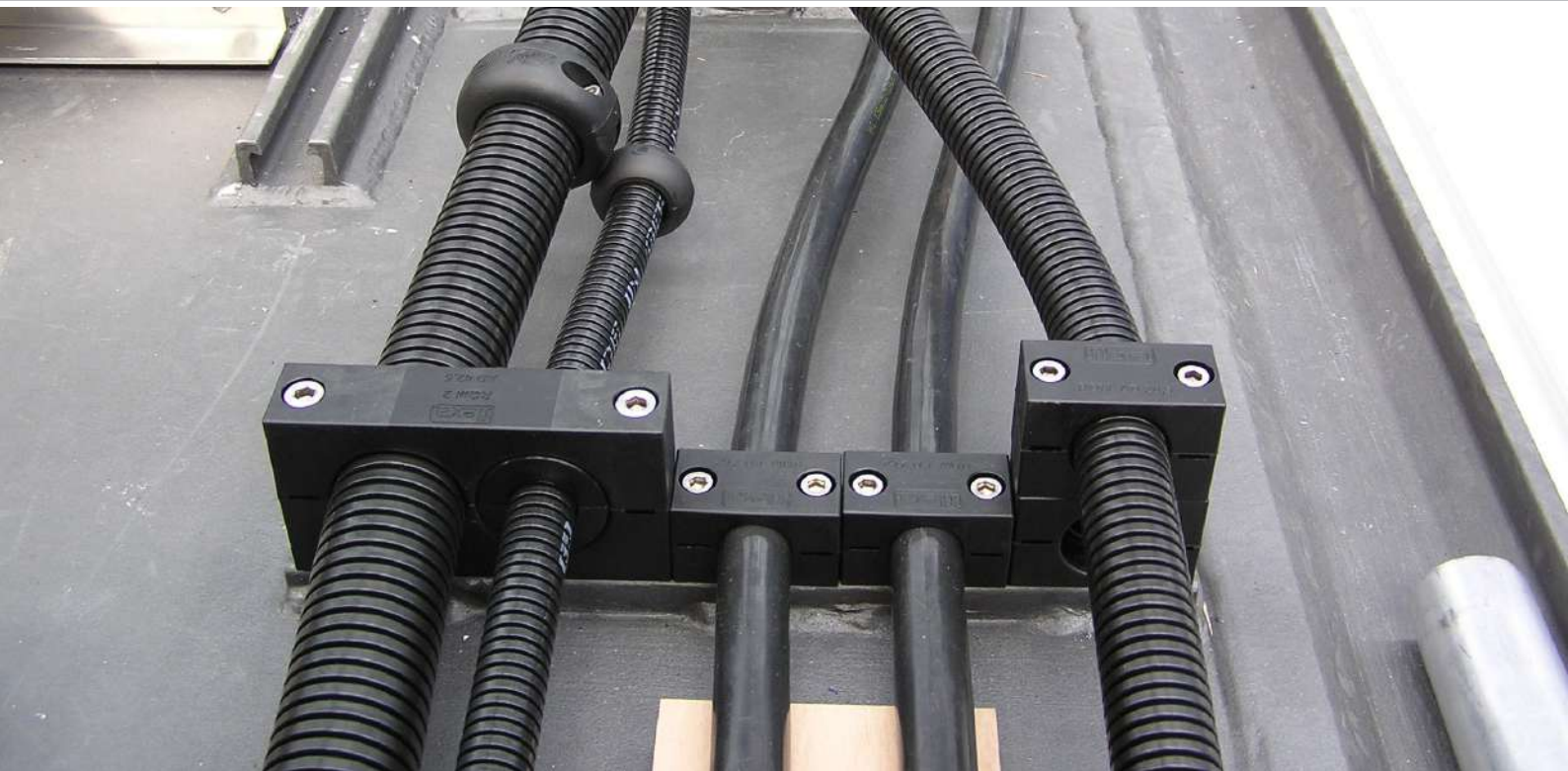

Ein umfangreiches Sortiment verschiedener Haltersysteme ist erhältlich für unterschiedliche Anwendungen.

Die stapelbaren Massiv-Schlauchhalter eignen sich speziell für erhöhte mechanische Beanspruchung im Schienenfahrzeugbau oder im Maschinenbau.

Das System bietet verschiedene Befestigungsmöglichkeiten, Zugentlastung mit Fixierungsrippen und ist dank passenden Reduzierungen aus Polyamid oder Kabelklemmeinsätzen aus TPE in unterschiedlichen Anwendungen einsetzbar.

### Wichtigste Eigenschaften

- Aus schlagfestem Polyamid
- Optimale Zugentlastung durch Rippenfixierung
- Schnelle, einfache Montage
- Gute Laugen- und Säurenbeständigkeit
- Halogenfrei
- In schwarz UV beständig

### Brandschutz Zertifikate für Schienenfahrzeuge

- EN 45545-2

Bezüglich Zertifikate und Zulassungen von Kabelschutzschläuchen, wenden Sie sich bitte direkt an Ihren Ansprechpartner im Vertrieb.

An extensive selection of various clamping systems is available for a wide range of applications.

Our stackable solid conduit clamps are designed especially for high mechanical stress in the construction of railway vehicles and machines.

The system offers a variety of mounting options, strain relief with fixing ribs and can be used in a wide range of applications thanks to matching polyamide reduction fittings and TPE cable-clamping inserts.

### Key properties

- Made of impact-resistant polyamide
- Optimal strain relief with fixing ribs
- Fast, simple assembly
- High resistance to acids and alkaline substances
- Halogen-free
- In black, UV-resistant

### Fire-protection certificates for railway vehicles

- EN 45545-2

For certificates and approvals for cable protection conduits, please contact your sales contact directly.

# Schlauchhalter mit Deckel RQS

## Conduit clamp with cover RQS

### Schlauchhalter zu Kunststoff Schutzschlauch | Conduit clamp for synthetic protective conduit

Material: Polyamid PA 6  
 Brandklasse: HB (UL 94)  
 Eigenschaften: Zugentlastung durch Rippenfixierung  
 Einsatzbereich: Zentrumsbefestigung mit Schraube oder einsetzbar in C-Profilschiene  
 Einsatztemperatur: -40°C / +120°C

Material: Polyamide PA 6  
 Fire classification: HB (UL 94)  
 Properties: With fixing ribs as strain relief  
 Application: Fastening with central screw or by insertion into a C-profile bar  
 Temperature range: -40°C / +120°C

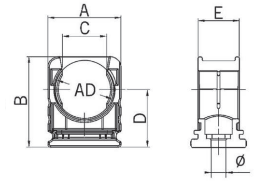

Schlauchhalter RQS  
 Schwarz

Conduit clamp RQS  
 Black

AD mm	A mm	B mm	C mm	D mm	E mm	Ø mm	Art.-Nr.   Art. No.	
10.0	21.0	23.5	8.5	13.0	16.0	5.5	5030.020.207	50
13.0	25.0	25.0	9.2	14.5	16.0	5.5	5030.020.209	50
15.8	27.0	27.0	11.2	16.0	16.0	6.5	5030.020.211	50
18.5	31.0	31.5	12.7	18.0	16.0	6.5	5030.020.213	50
21.2	33.0	34.0	16.1	21.0	16.0	6.5	5030.020.216	50
28.5	40.0	40.5	20.5	22.5	16.0	6.5	5030.020.221	25
34.5	46.0	47.0	25.7	26.0	16.0	6.5	5030.020.229	25
42.5	55.0	55.0	30.0	32.0	16.0	6.5	5030.020.236	25
54.5	67.0	69.5	38.0	39.0	16.0	6.5	5030.020.248	10

Auf Anfrage lieferbar: Available on request:  
 Ausführung in Grau Executions in grey



### Schlauch-Klemmschelle | Clamping collar for conduit

Material: Stahl verzinkt DIN 3016 mit Gummiprofil  
 Eigenschaften: Halogenfrei (Gummiprofil) hohe mechanische Belastbarkeit, gute Wetter-, Ozon- und Alterungsbeständigkeit  
 Einsatztemperatur: -40°C / +120°C

Material: Galvanised steel DIN 3016 with rubber profile  
 Properties: Without halogen (rubber profile), good resistance to mechanical stress, good resistance to weather, ozone and age  
 Temperature range: -40°C / +120°C

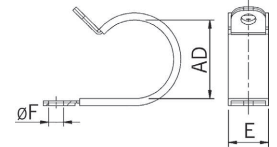

AD mm	ØF mm	E mm	Art.-Nr.   Art. No.	
10	5.3	12	0308.000.007	50
13	5.3	12	0308.012.013	50
14	5.3	12	0308.000.009	50
15.8	5.3	12	0308.012.016	50
17	5.3	12	0308.000.011	50
19-20	5.3	12	0308.000.013	50
21-22	5.3	12	0308.000.016	50
27-29	6.4	15	0308.000.021	50
34.5-36	6.4	15	0308.000.029	50
42.5-45	6.4	15	0308.000.036	25
54.5-57	6.4	15	0308.000.048	25





# Schlauchhalter klein RQH

## Conduit clamp small RQH

### Schlauchhalter zu Kunststoff Schutzschlauch | Conduit clamp for synthetic protective conduit

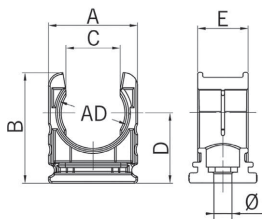

Material: Polyamid  
 Brandklasse: V0 (UL 94)  
 Eigenschaften: Zugentlastung durch Rippenfixierung  
 Einsatzbereich: Zentrumsbefestigung mit Schraube oder einsetzbar in C-Profilschiene  
 Einsatztemperatur: -40°C / +120°C

Material: Polyamide  
 Fire classification: V0 (UL 94)  
 Properties: With fixing ribs as strain relief  
 Application: Fastening with central screw or by insertion into a C-profile bar  
 Temperature range: -40°C / +120°C



Schlauchhalter RQH  
Schwarz

Conduit clamp RQH  
Black

AD mm	A mm	B mm	C mm	D mm	E mm	Ø mm	Art.-Nr.   Art. No.	
10.0	19.5	19.0	8.4	13.0	15.0	4.5	5030.025.207	50
13.0	19.5	22.6	9.3	14.5	15.0	4.5	5030.025.209	50
15.8	21.5	25.4	11.2	16.1	15.0	5.5	5030.025.211	50
18.5	24.5	33.0	12.6	18.0	15.0	5.5	5030.025.213	50
21.2	26.5	33.0	16.6	21.0	15.0	5.5	5030.025.216	50
28.5	34.7	39.4	20.4	22.7	15.0	5.5	5030.025.221	25
34.5	40.0	44.4	25.6	26.0	15.0	6.5	5030.025.229	25
42.5	54.5	55.5	30.1	32.0	20.0	6.5	5030.025.236	25
54.5	65.5	68.8	38.1	39.0	20.0	6.5	5030.025.248	10

### Deckel zu Schlauchhalter RQH | Cover for conduit clamp RQH

Material: Polyamid  
 Brandklasse: V0 (UL 94)  
 Einsatztemperatur: -40°C / +120°C

Material: Polyamide  
 Fire classification: V0 (UL 94)  
 Temperature range: -40°C / +120°C



Schwarz

Black

AD mm	Art.-Nr.   Art. No.	
10.0	5030.026.207	50
13.0	5030.026.209	50
15.8	5030.026.211	50
18.5	5030.026.213	50
21.2	5030.026.216	50
28.5	5030.026.221	25
34.5	5030.026.229	25
42.5	5030.026.236	25
54.5	5030.026.248	10

# Schlauchhalter klein RQH

## Conduit clamp small RQH

### Schlauchhalter zu Kunststoff Schutzschlauch | Conduit clamp for synthetic protective conduit

Material: Polyamid  
 Brandklasse: V0 (UL 94)  
 Eigenschaften: Zugentlastung durch Rippenfixierung  
 Einsatzbereich: Zentrumsbefestigung mit Schraube oder einsetzbar in C-Profilschiene  
 Einsatztemperatur: -40°C / +120°C

Material: Polyamide  
 Fire classification: V0 (UL 94)  
 Properties: With fixing ribs as strain relief  
 Application: Fastening with central screw or by insertion into a C-profile bar  
 Temperature range: -40°C / +120°C

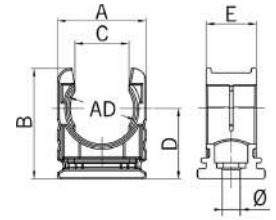

Schlauchhalter RQH Grau							Conduit clamp RQH Grey		
AD mm	A mm	B mm	C mm	D mm	E mm	Ø mm	Art.-Nr.   Art. No.		
10.0	19.5	19.0	8.4	13.0	15.0	4.5	5030.025.007	50	
13.0	19.5	22.6	9.3	14.5	15.0	4.5	5030.025.009	50	
15.8	21.5	25.4	11.2	16.1	15.0	5.5	5030.025.011	50	
18.5	24.5	33.0	12.6	18.0	15.0	5.5	5030.025.013	50	
21.2	26.5	33.0	16.6	21.0	15.0	5.5	5030.025.016	50	
28.5	34.7	39.4	20.4	22.7	15.0	5.5	5030.025.021	25	
34.5	40.0	44.4	25.6	26.0	15.0	6.5	5030.025.029	25	
42.5	54.5	55.5	30.1	32.0	20.0	6.5	5030.025.036	25	
54.5	65.5	68.8	38.1	39.0	20.0	6.5	5030.025.048	10	



### Deckel zu Schlauchhalter RQH | Cover for conduit clamp RQH

Material: Polyamid  
 Brandklasse: V0 (UL 94)  
 Einsatztemperatur: -40°C / +120°C

Material: Polyamide  
 Fire classification: V0 (UL 94)  
 Temperature range: -40°C / +120°C

Grau		Grey		
AD mm	Art.-Nr.   Art. No.			
10.0	5030.026.007	50		
13.0	5030.026.009	50		
15.8	5030.026.011	50		
18.5	5030.026.013	50		
21.2	5030.026.016	50		
28.5	5030.026.021	25		
34.5	5030.026.029	25		
42.5	5030.026.036	25		
54.5	5030.026.048	10		



# Schlauchhalter massiv RQM

## Heavy conduit clamp RQM

### Schlauchhalter kleine Bauform RQM | Conduit clamp small size RQM

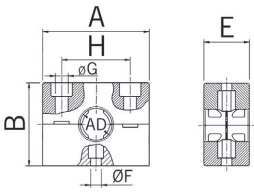

Material:	Flexamid V0 (HL 3)	Material:	Flexamide V0 (HL 3)
Brandklasse:	V0 (UL 94)	Fire classification:	V0 (UL 94)
Eigenschaften:	Zugentlastung durch Rippenfixierung	Properties:	With fixing ribs as strain relief
Einsatzbereich:	Breites Sortiment für alle Anforderungen im Installationsbereich.	Application:	Wide range of products for electric installation that covers all requirements.
Einsatztemperatur:	-40°C / +120°C	Temperature range:	-40°C / +120°C

EN 45545-2  
HL 3



Schlauchhalter RQM  
Kleine Bauform schwarz

Conduit clamp RQM  
Small type black

AD mm	A mm	B mm	E mm	ØF mm	ØG mm	H mm	Art.-Nr.   Art. No.	
15.8	50	33	30	7	6.5	34	5020.006.211	10
21.2	54	33	30	7	6.5	38	5020.006.216	10
22.5 *)	54	33	30	7	6.5	38	5020.006.217	10
28.5	60	40	30	7	6.5	44	5020.006.221	10

\*) ohne Rippenfixierung

\*) without ribbed fixing

### Schlauchhalter 2-fach | Double conduit clamp

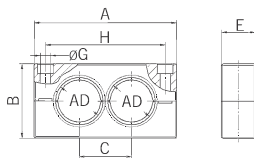

Schlauchhalter RQM2  
Kleine Bauform schwarz

Conduit clamp RQM2  
Small type black

AD mm	A mm	B mm	C mm	E mm	ØG mm	H mm	Art.-Nr.   Art. No.	
2 x 28.5	92	40	46	30	6.5	46	5020.008.204	10

EN 45545-2  
HL 3

### Schlauchhalter 3-fach | Triple conduit clamp

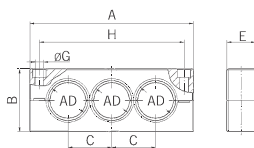

Schlauchhalter RQM3  
Kleine Bauform schwarz

Conduit clamp RQM3  
Small type black

AD mm	A mm	B mm	C mm	E mm	ØG mm	H mm	Art.-Nr.   Art. No.	
3 x 28.5	125	40	46	30	6.5	46	5020.008.205	10

EN 45545-2  
HL 3

# Schlauchhalter massiv RQM Heavy conduit clamp RQM

## Schlauchhalter massiv RQM | Heavy conduit clamp RQM

Material:	Flexamid V0 (HL 3)	Material:	Flexamide V0 (HL 3)
Brandklasse:	V0 (UL 94)	Fire classification:	V0 (UL 94)
Eigenschaften:	Zugentlastung durch Rippenfixierung	Properties:	With fixing ribs as strain relief
Einsatzbereich:	Breites Sortiment für alle Anforderungen im Installationsbereich.	Application:	Wide range of products for electric installation that covers all requirements.
Einsatztemperatur:	-40°C / +120°C	Temperature range:	-40°C / +120°C

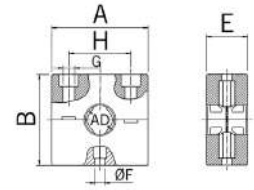

EN 45545-2  
HL 3

Schlauchhalter RQM Schwarz							Conduit clamp RQM Black		
AD mm	A mm	B mm	E mm	ØF mm	ØG mm	H mm	Art.-Nr.   Art. No.		
21.2	65	66	30	7.0	6.5	45	5020.020.216	10	
28.5	65	66	30	7.0	6.5	45	5020.020.221	10	
34.5	80	66	30	7.0	8.5	60	5020.020.229	10	
42.5	80	66	30	7.0	8.5	60	5020.020.236	10	
54.5	100	66	30	-	8.5	75	5020.020.248	5	



## Schlauchhalter 2-fach | Double conduit clamp

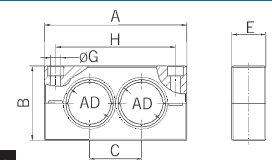

EN 45545-2  
HL 3

Schlauchhalter RQM2 Schwarz							Conduit clamp RQM2 Black		
AD mm	A mm	B mm	C mm	E mm	ØG mm	H mm	Art.-Nr.   Art. No.		
2 x 42.5	126	66	45.5	30	8.5	106	5020.008.201	10	



## Schlauchhalter 3-fach | Triple conduit clamp

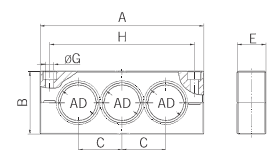

EN 45545-2  
HL 3

Schlauchhalter RQM3 Schwarz							Conduit clamp RQM3 Black		
AD mm	A mm	B mm	C mm	E mm	ØG mm	H mm	Art.-Nr.   Art. No.		
3 x 42.5	172	66	45.5	30	8.5	152	5020.008.202	10	
3 x 54.5	209	66	57.5	30	8.5	190	5020.008.208	5	



# Scheuerschutz, Reduzierringe zu Schlauchhalter massiv RQM

## Abrasion protection, reduction rings for heavy conduit clamp RQM

### Schrauben zu Massiv-Schlauchhalter | Screw for heavy conduit clamp

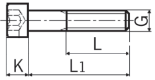

Material: Stahl 8.8 schwarz  
Eigenschaften: für gestapelte Montage Schlauchhalter RQM

Material: Steel 8.8 black  
Properties: for stacked installation of conduit clamps RQM



Passend zu Schlauchhalter RQM  
Zylindrische Schrauben nach DIN 912

Fits conduit clamp RQM  
Zylindric screw DIN 912

	 mm	 mm	<b>K</b> mm	<b>L1</b> mm	<b>L</b> mm	<b>Art.-Nr.   Art. No.</b>	
<b>M6</b>	5	6	65	24		<b>0541.106.065</b>	100
<b>M6</b>	5	6	130	24		<b>0541.106.130</b>	100
<b>M8</b>	6	8	65	28		<b>0541.108.065</b>	100
<b>M8</b>	6	8	130	28		<b>0541.108.130</b>	100

### Scheuerschutz für Kunststoff Schutzschlauch | Abrasion protection for synthetic protective conduit

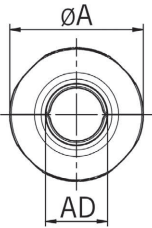

Material: Flexamid V0 (HL 3)  
Brandklasse: V0 (UL 94)  
Einsatzbereich: Passend zu ROHRflex® Well-schlauch  
Zugentlastung: durch Rippenfixierung  
Einsatztemperatur: -40°C / +120°C

Material: Flexamide V0 (HL 3)  
Fire classification: V0 (UL 94)  
Application: Suitable for ROHRflex® corrugated tubings  
Strain relief: Ribbed fixing  
Temperature range: -40°C / +120°C

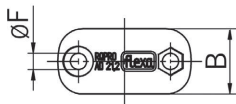

Schwarz				Black					
<b>AD</b> mm	<b>ØA</b> mm	<b>B</b> mm	<b>ØF</b> mm			<b>Art.-Nr.   Art. No.</b>			
<b>21.2</b>	45	22.0	5.5			<b>5524.021.200</b>	25		
<b>28.5</b>	52	26.0	5.5			<b>5524.028.200</b>	25		
<b>34.5</b>	58	26.0	5.5			<b>5524.034.200</b>	10		
<b>42.5</b>	66	30.0	5.5			<b>5524.042.200</b>	10		
<b>54.5</b>	77	29.8	5.5			<b>5524.054.200</b>	5		
<b>NW 56</b>	90	33.0	5.5			<b>5524.067.200</b>	5		
<b>NW 70</b>	109	60.0	5.5			<b>5524.079.200</b>	5		

EN 45545-2  
HL 3

### Reduzierringe zu Schlauchhalter RQM | Reduction rings for conduit clamp RQM

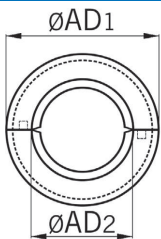

Material: Flexamid V0 (HL 3)  
Brandklasse: V0 (UL 94)  
Einsatzbereich: Reduzierring für ROHRflex® Well-schlauch  
Zugentlastung: durch Rippenfixierung  
Einsatztemperatur: -40°C / +120°C

Material: Flexamide V0 (HL 3)  
Fire classification: V0 (UL 94)  
Application: Reduction ring for ROHRflex® corrugated conduit  
Strain relief: Ribbed fixing  
Temperature range: -40°C / +120°C



Schwarz			Black				
<b>AD1</b> mm	<b>AD2</b> mm	<b>E</b> mm			<b>Art.-Nr.   Art. No.</b>		
<b>42.5</b>	15.8	30			<b>5605.042.215</b>	10	
<b>42.5</b>	21.2	30			<b>5605.042.221</b>	10	
<b>42.5</b>	28.5	30			<b>5605.042.228</b>	10	
<b>42.5</b>	34.5	30			<b>5605.042.234</b>	10	

EN 45545-2  
HL 3



# Klemmeinsatz zu Schlauchhalter massiv RQM Claming insert for heavy conduit clamp RQM

## Klemmeinsatz zu Schlauchhalter RQM | Clamping insert for conduit clamp RQM

Material: TPE  
Brandklasse: V0 (UL 94)  
Eigenschaften: Halogen- und phosphorfrei gemäss DIN 53474, beständig gegen Kraftstoffe, Mineralöle, Fette, Alkalien, Glykole, Säuren, Basen, verschiedene Lösungsmittel  
Einsatzbereich: Schonende Halterung und Fixierung von Stromkabeln, auch bei dynamischer Anwendung  
Einsatztemperatur: -40°C / +120°C

Material: TPE  
Fire classification: V0 (UL 94)  
Properties: Free of halogen and phosphor according to EN 53474, resistant to motor fuels, mineral oil, fat, alkalines, glycols, acids, bases, common solvents  
Application: Gentle support and fixing of electric cables, also for dynamic applications  
Temperature range: -40°C / +120°C

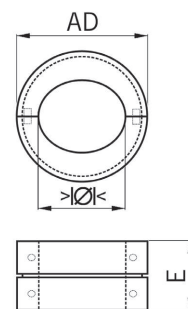

passend zu Schlauchhalter RQM und Scheuerschutz Schwarz  
For conduit clamp RQM and abrasion protection Black

AD mm	>Ø< min mm	>Ø< max mm	E mm	Art.-Nr.   Art. No.	
15.8	7.0	10.0	30	5606.015.207	10
21.2	10.0	14.0	30	5606.021.210	10
28.5	10.0	14.0	30	5606.028.210	10
28.5	14.0	18.0	30	5606.028.214	10
28.5	16.0	20.0	30	5606.028.216	10
28.5	19.0	23.0	30	5606.028.219	10
42.5	18.0	22.0	30	5606.042.218	10
42.5	22.0	26.0	30	5606.042.222	10
42.5	26.0	30.0	30	5606.042.226	10
42.5	30.0	34.0	30	5606.042.230	10
54.5	34.0	38.0	30	5606.054.234	10
54.5	38.0	42.0	30	5606.054.240	10
54.5	42.0	46.0	30	5606.054.242	10



## Kunststoffreduzierung RQMR-Move | Syntetic Reduction RQMR-Move

Material: Polyamid PA 6  
Brandklasse: V0 (UL 94)  
Einsatzbereich: Beweglicher Einsatz für flexible Anwendungen bei dynamischer Belastung Halogenfrei  
Zugentlastung: Durch Rippenfixierung  
Einsatztemperatur: -40°C / +120°C

Material: Polyamid PA 6  
Fire classification: V0 (UL 94)  
Application: Moveable insert for flexible applications for dynamic applications Halogen-free  
Strain relief: Ripped fixing  
Temperature range: -40°C / +120°C

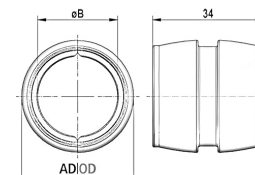

Beweglicher Einsatz zu Schlauchhalter Rot  
Movable insert for conduit clamp Red

AD mm	B mm	Art.-Nr.   Art. No.	
34.5	28.5	5607.028.234	10
42.5	34.5	5607.034.242	10
54.5	42.5	5607.042.254	10

EN 45545-2  
HL 3



## Schutzschläuche aus Metall und Kunststoff nicht flüssigkeitsdicht und flüssigkeitsdicht Conduit made of metal and synthetic materials, both liquid-tight and non liquid-tight



**Kabelschutzschläuche aus Metall oder Kunststoff** sind erhältlich für Einsatzgebiete von  $-60^{\circ}\text{C}$  bis  $+230^{\circ}\text{C}$ , für Schutzarten bis IP 68, sind lösemittelresistent, nicht flüssigkeitsdicht und flüssigkeitsdicht oder ummantelt mit PVC, PU oder Silikon.

Die Metallschläuche sind mit einfach gefalztem und doppelt gefalztem Profil erhältlich.

In der Praxis sind Kabelschutzschläuche im Maschinen- und Anlagenbau, in der Automation, Energietechnik, im Fahrzeug- sowie im Schienenfahrzeugbau zu finden.

Sie schirmen Datenleitungen vor elektromagnetischen Einflüssen ab, schützen Leitungen vor Bruch und Beschädigungen oder sorgen in der Medizinaltechnik für Biegeschutz oder leichte Desinfizierbarkeit.

### Wichtigste Eigenschaften

- Hochflexibel
- Zugfest und querdruckbelastbar
- Für schwere mechanische Beanspruchung
- Geeignet für den Einsatz im Ex-Bereich
- Gute Laugen- und Säurenbeständigkeit
- Geprüft nach EN / IEC 61386-23
- In schwarz UV beständig

**Cable conduits made of metal or synthetic materials** are available for applications in the temperature range from  $-60^{\circ}\text{C}$  to  $+230^{\circ}\text{C}$ , for Protection Classes up to IP 68, are resistant to solvents, are available in versions impervious to liquids, and with jackets made of PVC, PU or silicone.

Metal conduits are available with single and double-overlapped profiles.

In practice, cable protective conduits can be found in the construction of machines and systems, in automation and power engineering applications as well as in the design of road and railway vehicles.

They shield data lines from the influence of electromagnetic fields, protect cables from breakage and damage or, in medical technology, protect against excess bending and provide for easy disinfection.

### Key properties

- Extremely flexible
- Withstands high tensile stress and are crush-resistant
- Designed to handle heavy mechanical loads
- Suitable for use in Ex environments
- Fast, simple assembly
- High resistance to acids and alkaline substances
- Tested to EN / IEC 61386-23
- In black, UV-resistant



Metallschutzschlauch nicht flüssigkeitsdicht Protective metal conduit non liquid-tight	 <b>78 - 79</b>	1
Metallschutzschlauch flüssigkeitsdicht Protective metal conduit liquid-tight	 <b>80 - 83</b>	2
Kunststoff Schutzschlauch flüssigkeitsdicht Protective synthetic conduit liquid-tight	 <b>84 - 86</b>	3

- 1
- 2
- 3
- 4**
- 5
- 6
- 7
- 8
- 9
- 10
- 11
- 12

# Metallschutzschlauch nicht flüssigkeitsdicht

## Protective metal conduit non liquid-tight

### SPR-AS | SPR-AS

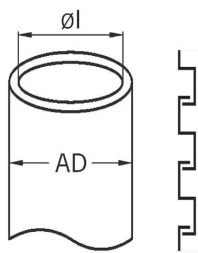

Material: Stahl verzinkt  
 Eigenschaften: Hochflexibel, zugfest, querdruckbelastbar  
 Anwendung: Für schwere mechanische Beanspruchung nach DIN 49012, Bauform G, geeignet für den Einsatz im Ex-Bereich nach EN 1127-1  
 Einsatzbereich: Maschinen- und Anlagenbau, Fahrzeugbau, Schiffsbau, Automation, Elektroanlagen  
 Geprüft nach: EN / IEC 61386-23  
 Schutzart: IP 40  
 Einsatztemperatur: -50°C / +250°C

Material: zinc coated steel  
 Properties: Highly flexible, stretch resistant, lateral crush resistant  
 Application: For heavy mechanical stress acc. to DIN 49012, type G, suitable for application in Ex environment acc. to EN 1127-1  
 Application: Machine and plant constructions, vehicle construction, shipbuilding, automation, electrical installations  
 Tested acc. to: EN / IEC 61386-23  
 Protection class: IP 40  
 Temperature range: -50°C / +250°C



Metallschutzschlauch nicht flüssigkeitsdicht SPR-AS					Protective metal conduit non liquid-tight SPR-AS		
AD mm	øl mm	R±10% stat mm	R±10% dyn mm	Hülse Douille/Bush	Art.-Nr.   Art. No.		
10	8	20	50	5031.027.007	1010.111.008	50	50
14	11	28	70	5031.027.009	1010.111.011	50	50
17	14	30	75	5031.027.011	1010.111.014	50	50
19	16	35	90	5031.027.013	1010.111.016	50	50
21	18	40	100	5031.027.016	1010.111.018	50	50
27	23	48	120	5031.027.021	1010.111.023	50	50
36	31	60	150	5031.027.029	1010.111.031	25	25
45	40	82	205	5031.027.036	1010.111.040	25	25
56	51	100	250	5031.027.048	1010.111.051	25	25

### SPR-VA | SPR-VA

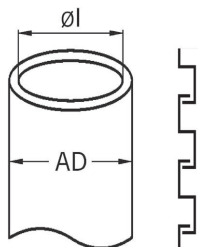

Material: Rostfreier Stahl A2  
 Eigenschaften: Hochflexibel, zugfest, querdruckbelastbar, hoch temperaturbeständig  
 Anwendung: Für schwere mechanische Beanspruchung, geeignet für den Einsatz im Ex-Bereich nach EN 1127-1  
 Einsatzbereich: Maschinen- und Anlagenbau, Fahrzeugbau, Schiffsbau, Automation, Elektroanlagen, Sensortechnik  
 Schutzart: IP 40  
 Einsatztemperatur: -200°C / +600°C

Material: Stainless steel A2  
 Properties: Highly flexible, stretch resistant, lateral crush resistant, high temperature stability  
 Application: For heavy mechanical stress, suitable for application in Ex environment according to EN 1127-1  
 Application: Machine and plant constructions, vehicle construction, shipbuilding, automation, electrical installations, sensor technology  
 Protection class: IP 40  
 Temperature range: -200°C / +600°C



Metallschutzschlauch nicht flüssigkeitsdicht SPR-VA					Protective metal conduit non liquid-tight SPR-VA		
AD mm	øl mm	R±10% stat mm	R±10% dyn mm	Hülse Douille/Bush	Art.-Nr.   Art. No.		
10	8	20	50	5031.027.007	1010.801.008	50	50
14	11	28	70	5031.027.009	1010.801.011	50	50
17	14	30	75	5031.027.011	1010.801.014	50	50
19	16	35	90	5031.027.013	1010.801.016	50	50
21	18	40	100	5031.027.016	1010.801.018	50	50
27	23	48	120	5031.027.021	1010.801.023	50	50
36	31	60	150	5031.027.029	1010.801.031	25	25
45	40	82	205	5031.027.036	1010.801.040	25	25
56	51	100	250	5031.027.048	1010.801.051	25	25

# Metallschutzschlauch nicht flüssigkeitsdicht

## Protective metal conduit non liquid-tight

FLEXAgraff®-AS | FLEXAgraff®-AS

Material:	Stahl verzinkt, doppelt gefalzt	Material:	Steel galvanized, double-overlapped
Eigenschaften:	Hohe Zugfestigkeit, hohe Verdrehungsfestigkeit, kein Aufdrehen des Schlauches, sehr flexibel	Properties:	High tensile, torsional- and bending strength, highly flexible, no untwisting of the conduit
Anwendung:	Schutzschlauch u.a. für Hydraulik- und Pneumatikschläuche, geeignet für den Einsatz im Ex-Bereich nach EN 1127-1	Application:	Protective conduit e.g. for hydraulic and pneumatic conduits, suitable for application in Ex environment acc. to EN 1127-1
Einsatzbereich:	Maschinen- und Anlagenbau, Fahrzeugbau, Schiffsbau, Automation, Elektroanlagen	Application:	Machine and plant constructions, vehicle construction, shipbuilding, automation, electrical installations
Geprüft nach:	EN / IEC 61386-23	Tested acc. to:	EN / IEC 61386-23
Schutzart:	IP 40	Protection class:	IP 40
Einsatztemperatur:	-50°C / +250°C	Temperature range:	-50°C / +250°C

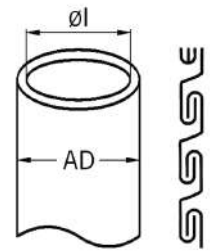

Metallschutzschlauch nicht flüssigkeitsdicht FLEXAgraff®-AS					Protective metal conduit non liquid-tight FLEXAgraff®-AS		
AD mm	Øl mm	R±10% stat mm	R±10% dyn mm	Hülse Douille/Bush	Art.-Nr.   Art. No.		
10	8	40	100	5031.027.007	1080.101.008	50	
14	12	50	125	5031.039.009	1080.101.012	50	
17	14	60	150	5031.027.011	1080.101.014	50	
19	16	67	170	5031.027.013	1080.101.016	50	
21	18	70	175	5031.027.016	1080.101.018	50	
27	24	90	225	5031.039.021	1080.101.024	50	
36	31	130	325	5031.027.029	1080.101.031	25	
45	40	150	375	5031.027.036	1080.101.040	25	
56	51	210	525	5031.027.048	1080.101.051	25	

Auf Anfrage lieferbar:	Available on request:
Rostfreier Stahl A2	Stainless steel A2





# Metallschutzschlauch flüssigkeitsdicht

## Protective metal conduit liquid-tight

SPR-PVC-AS | SPR-PVC-AS

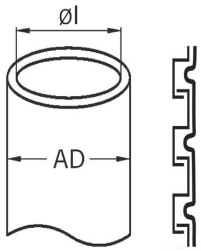

Material: Stahl verzinkt  
 Aussenmantel: PVC  
 Eigenschaften: Wetterfest, wasserdicht, weitgehend seewasser-, säure- und ölbeständig, silikon- und cadmiumfrei, sehr flexibel, zugfest, querdruckbelastbar  
 Anwendung: Für schwere mechanische Beanspruchung nach DIN 49012, Bauform I  
 Einsatzbereich: Maschinen- und Anlagenbau, Fahrzeugbau, Schiffsbau, Automation, Elektroanlagen  
 Geprüft nach: EN / IEC 61386-23  
 Schutzart: IP 68  
 Einsatztemperatur: -25°C / +90°C / ^ +100°C

Material: zinc coated steel  
 Sheathing: PVC  
 Properties: Weatherproof, watertight, widely resistant to seawater, acids and oils, free of silicone and cadmium, very flexible, stretch and crush resistant  
 Application: For heavy mechanical stress acc. to DIN 49012, type I  
 Application: Machine and plant constructions, vehicle construction, shipbuilding, automation, electrical installations  
 Tested acc. to: EN / IEC 61386-23  
 Protection class: IP 68  
 Temperature range: -25°C / +90°C / ^ +100°C



Metallschutzschlauch flüssigkeitsdicht  
 SPR-PVC-AS  
 Schwarz

Protective metal conduit liquid-tight  
 SPR-PVC-AS  
 Black

AD mm	øl mm	R±10% stat mm	R±10% dyn mm	Hülse Douille/Bush	Art.-Nr.   Art. No.	
10	7	25	65	5031.028.007	2010.112.007	50
14	10	37	95	5031.028.009	2010.112.010	50
17	13	45	115	5031.028.011	2010.112.013	50
19	15	50	120	5031.028.013	2010.112.015	50
21	17	55	140	5031.028.016	2010.112.017	50
27	22	60	150	5031.028.021	2010.112.022	50
36	29	90	225	5031.028.029	2010.112.029	25
45	38	120	300	5031.028.036	2010.112.038	25
56	49	130	325	5031.028.048	2010.112.049	25



Metallschutzschlauch flüssigkeitsdicht  
 SPR-PVC-AS  
 Grau

Protective metal conduit liquid-tight  
 SPR-PVC-AS  
 Grey

AD mm	øl mm	R±10% stat mm	R±10% dyn mm	Hülse Douille/Bush	Art.-Nr.   Art. No.	
10	7	25	65	5031.028.007	2010.111.007	50
14	10	37	95	5031.028.009	2010.111.010	50
17	13	45	115	5031.028.011	2010.111.013	50
19	15	50	120	5031.028.013	2010.111.015	50
21	17	55	140	5031.028.016	2010.111.017	50
27	22	60	150	5031.028.021	2010.111.022	50
36	29	90	225	5031.028.029	2010.111.029	25
45	38	120	300	5031.028.036	2010.111.038	25
56	49	130	325	5031.028.048	2010.111.049	25



# Metallschutzschlauch flüssigkeitsdicht

## Protective metal conduit liquid-tight

SPR-PU-AS | SPR-PU-AS

Material: Stahl verzinkt  
 Aussenmantel: Polyurethan  
 Eigenschaften: Öl-, benzin-, fettbeständig, weitgehend lösungsmittel- und säurebeständig, halogen-, silikon- und cadmiumfrei, hohe Zähigkeit und Abriebbeständigkeit, hervorragendes Verhalten bei tiefen Temperaturen, sehr flexibel, mikrobebeständig

Anwendung: Für schwere mechanische Beanspruchung nach DIN 49012, Bauform I, Schutz vor Öl, Fett und Benzin

Einsatzbereich: Maschinen- und Anlagenbau, Fahrzeugbau, Schienenfahrzeuge im Aussenbereich, Schiffsbau, Automation, Elektroanlagen

Geprüft nach: EN / IEC 61386-23  
 Schutzart: IP 68  
 Einsatztemperatur: -50°C / +100°C / ^ +130°C

Material: zinc coated steel  
 Sheathing: Polyurethane  
 Properties: Oil-, petrol- and grease-resistant, widely resistant to solvents and acids, halogen-free, free of silicone and cadmium, highly tenacity and abrasion resistance, outstanding qualities at low temperature, very flexible, microbe-resistant

Application: For heavy mechanical stress acc. to DIN 49012, type I, for protection against oil, grease and petrol

Application: Machine and plant constructions, vehicle construction, rail vehicles outside applications, shipbuilding, automation, electrical installations

Tested acc. to: EN / IEC 61386-23  
 Protection class: IP 68  
 Temperature range: -50°C / +100°C / ^ +130°C

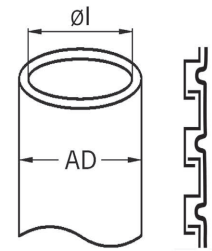

Metallschutzschlauch flüssigkeitsdicht SPR-PU-AS Metallic-Blau				Protective metal conduit liquid-tight SPR-PU-AS Metallic blue		
AD mm	øl mm	R±10% stat mm	R±10% dyn mm	Hülse Douille/Bush	Art.-Nr.   Art. No.	
10	7	25	65	5031.028.007	2210.711.007	50
14	10	37	95	5031.028.009	2210.711.010	50
17	13	45	115	5031.028.011	2210.711.013	50
21	17	55	140	5031.028.016	2210.711.017	50
27	22	60	150	5031.028.021	2210.711.022	50
36	29	90	225	5031.028.029	2210.711.029	25
45	38	120	300	5031.028.036	2210.711.038	25
56	49	130	325	5031.028.048	2210.711.049	25

Auf Anfrage lieferbar: Aussenmantel aus Polyamid  
 Available on request: Sheathing in polyamide



# Metallschutzschlauch flüssigkeitsdicht

## Protective metal conduit liquid-tight

FLEXAgraff®-PU-AS | FLEXAgraff®-PU-AS

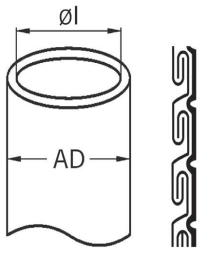

Material:	Stahl verzinkt, doppelt gefalzt	Material:	Steel galvanized, double-overlapped
Außenmantel:	Polyurethan	Sheathing:	Polyurethane
Eigenschaften:	Hohe Zug- und Verdrehungsfestigkeit durch doppelt gefalztes Agraff-Profil, hohe EMV-Abschirmung, hervorragendes Verhalten bei tiefen Temperaturen, kein Aufdrehen des Schlauchs, Oel-, benzin-, fettbeständig, sehr flexibel, flammgeschützt V2 nach UL 94	Properties:	High tensile and twisting strength thanks to double-overlapped profile (Agraff), high EMC shielding factor, outstanding performance at low temperatures, no untwisting of the conduit, resistant to oil, petrol and grease, very flexible, flame-resistant V2 according to UL 94
Anwendung:	Für hohe zug- und verdrehbeanspruchte, flüssigkeitsdichte Installationen und bei EMV-Anwendungen	Application:	For liquid tight installations that require high tensile and twisting strengths and for EMC applications
Einsatzbereich:	Maschinen- und Anlagenbau, Fahrzeugbau, Schienenfahrzeuge im Außenbereich, Schiffsbau, Automation, Elektroanlagen	Application:	Machine and plant constructions, vehicle construction, rail vehicles outside applications, shipbuilding, automation, electrical installations
Geprüft nach:	EN / IEC 61386-23	Tested acc. to:	EN / IEC 61386-23
Schutzart:	IP 68	Protection class:	IP 68
Einsatztemperatur:	-50°C / +100°C / ^ +130°C	Temperature range:	-50°C / +100°C / ^ +130°C



Metallschutzschlauch flüssigkeitsdicht FLEXAgraff®-PU-AS Metallic-Blau					Protective metal conduit liquid-tight FLEXAgraff®-PU-AS Metallic blue	
AD mm	øl mm	R±10% stat mm	R±10% dyn mm	Hülse Douille/Bush	Art.-Nr.   Art. No.	
10	7	35	90	5031.028.007	2130.101.007	50
14	11	45	115	5031.027.009	2130.101.011	50
17	13	50	125	5031.028.011	2130.101.013	50
21	17	75	190	5031.028.016	2130.101.017	50
27	23	115	290	5031.027.021	2130.101.023	50
36	29	125	315	5031.028.029	2130.101.029	25
45	38	175	440	5031.028.036	2130.101.038	25
56	49	240	600	5031.028.048	2130.101.049	25

Schwarz auf Anfrage      Colour black on request

# Metallschutzschlauch flüssigkeitsdicht

## Protective metal conduit liquid-tight

FLEXAgraff®-SI-ASF | FLEXAgraff®-SI-ASF

Material:	Stahl verzinkt, doppelt gefalzt	Material:	Steel galvanized, double-overlapped
Aussenmantel:	Silikon	Sheathing:	Silicone
Eigenschaften:	Hohe Zug- und Verdrehungsfestigkeit durch doppelt gefalztes Agraff-Profil, gute elektrische Isolation durch Silikonmantel, sehr gute Beständigkeit gegen Ozon, UV-Strahlen, Witterungseinflüsse, kein Aufdrehen des Schlauchs, Öl-, benzin-, fettbeständig, sehr flexibel, schwer entflammbar, halogenfrei, antitoxisch, hoch temperaturbeständig	Properties:	High tensile strength and torsional safety due to double overlapped profile, silicone jacket provides good electrical insulation, very good resistance to ozone, ultra-violet radiation and atmospheric influences, no untwisting of the conduit, oil, petrol and grease-resistant, very flexible, low flammability, free of halogen, anti-toxic, high temperature stability
Anwendung:	Für hohe zug- und verdrehungsbeanspruchte, flüssigkeitsdichte Installationen	Application:	For installations requiring high tensile strength, torsional resistance and liquid-proofness
Einsatzbereich:	Maschinen- und Anlagenbau, Fahrzeugbau, Schienenfahrzeuge im Aussenbereich, Schiffsbau, Automation, Elektroanlagen	Application:	Machine and plant constructions, vehicle construction, rail vehicles outside applications, shipbuilding, automation, electrical installations
Geprüft nach:	EN / IEC 61386-23	Tested acc. to:	EN / IEC 61386-23
Schutzart:	IP 68	Protection class:	IP 68
Einsatztemperatur:	-50°C / +180°C	Temperature range:	-50°C / +180°C

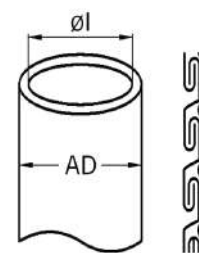

Metallschutzschlauch flüssigkeitsdicht FLEXAgraff®-SI-ASF Grau		Protective metal conduit liquid-tight FLEXAgraff®-SI-ASF Grey				
AD mm	øl mm	R±10% stat mm	R±10% dyn mm	Hülse Douille/Bush	Art.-Nr.   Art. No.	
14	10	50	125	5031.037.009	2140.801.010	50
17	12	60	150	5031.037.011	2140.801.012	50
21	16	70	175	5031.035.016	2140.801.016	50
27	21	90	225	0601.000.021	2140.801.022	50
36	27	130	325	5031.037.029	2140.801.028	25
45	37	150	375	5031.037.036	2140.801.037	25
56	47	210	525	5031.037.048	2140.801.048	25

Bei Einsatztemperatur über +80°C PTFE-Dichtring erforderlich!

For applications exceeding +80°C PTFE-sealing required!



# Kunststoff Schutzschlauch flüssigkeitsdicht

## Synthetic protective conduit liquid-tight

AIRflex®-KUW-PVC-AS | AIRflex®-KUW-PVC-AS

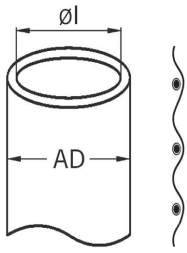

Material:	PVC-Aussenmantel, Innenwendel Federstahldraht PVC-ummantelt	Material:	Soft PVC jacket, helix of PVC sheathed spring steel wire
Eigenschaften:	Hochflexibel, dehn- und stauchbar, luft- und flüssigkeitsdicht, weitgehend säure- und ölbeständig, silikon- und cadmiumfrei, innerer Korrosionsschutz durch PVC-ummantelten Federstahldraht	Properties:	Extremely flexible, highly expandible and upsettable, airtight and liquid-proof, widely resistant to oil and acids, free of silicone and cadmium, inside protection against corrosion due to PVC-sheathed spring steel wire
Anwendung:	In feuchten Räumen, im Außenbereich, spezieller Einsatz in Führungsketten und an Robotern	Application:	In humid locations and outdoor areas, especially suitable for applications with guide chains and robotics
Einsatzbereich:	Maschinen- und Anlagenbau, Fahrzeugbau, Schiffsbau, Automation, Elektroanlagen	Application:	Machine and plant constructions, vehicle construction, shipbuilding, automation, electrical installations
Geprüft nach:	EN / IEC 61386-23	Tested acc. to:	EN / IEC 61386-23
Schutzart:	IP 68	Protection class:	IP 68
Einsatztemperatur:	-25°C / +90°C / ^ +100°C	Temperature range:	-25°C / +90°C / ^ +100°C



Kunststoff Schutzschlauch flüssigkeitsdicht  
AIRflex®-KUW-PVC-AS  
Grau

Synthetic protective conduit liquid-tight  
AIRflex®-KUW-PVC-AS  
Grey

AD mm	øl mm	R±10% stat mm	R±10% dyn mm	Hülse Douille/Bush	Art.-Nr.   Art. No.	
10	7	8	20	5020.030.007	2030.101.007	50
14	10	10	25	5020.030.009	2030.101.010	50
17	13	13	35	5020.030.011	2030.101.013	50
19	15	15	40	5020.030.013	2030.101.015	50
21	16	17	45	5020.030.016	2030.101.016	50
27	22	20	50	5020.030.021	2030.101.021	50
36	29	25	65	5020.030.029	2030.101.029	25
45	38	36	90	5020.030.036	2030.101.038	25
56	48	40	100	5020.030.048	2030.101.048	25



# Kunststoff Schutzschlauch flüssigkeitsdicht

## Synthetic protective conduit liquid-tight

AIRflex®-KUW-PU-AS | AIRflex®-KUW-PU-AS

**Material:** Polyurethan-Aussenmantel, Innenwendel Federstahldraht kunststoffummantelt

**Eigenschaften:** Hochflexibel, dehn- und stauchbar, luft- und flüssigkeitsdicht, hohe Zähigkeit und Abriebbeständigkeit, öl-, benzin- und fettbeständig, weitgehend lösungsmittel- und säurebeständig, halogen-, silikon- und cadmiumfrei, mikrobebeständig, hervorragendes Verhalten bei tiefen Temperaturen, innerer Korrosionsschutz durch kunststoffummantelten Federstahldraht

**Anwendung:** Für hochflexible, flüssigkeitsdichte Installationen, bei besonderem Schutz vor Öl, Fett und Benzin, spezieller Einsatz in Führungsketten und an Robotern

**Einsatzbereich:** Maschinen- und Anlagenbau, Fahrzeugbau, Schiffsbau, Automation, Elektroanlagen

**Geprüft nach:** EN / IEC 61386-23

**Schutzart:** IP 68

**Einsatztemperatur:** -40°C / +100°C / ^ +120°C

**Material:** Polyurethane jacket, inside helix of plastic sheathed spring steel wire

**Properties:** Extremely flexible, highly expandable and upsettable, airtight and liquid-proof, high tenacity and abrasion resistance, oil, petrol and grease-resistant, widely resistant to solvents and acids, free of halogen, silicone and cadmium, microbe-resistant, outstanding performance at low temperatures, inside protection against corrosion due to the sheathed spring steel wire

**Application:** For highly flexible, liquid-proof installations, for protection against oil, grease and petrol, especially suitable for applications with guide chains and robotics

**Application:** Machine and plant constructions, vehicle construction, shipbuilding, automation, electrical installations

**Tested acc. to:** EN / IEC 61386-23

**Protection class:** IP 68

**Temperature range:** -40°C / +100°C / ^ +120°C

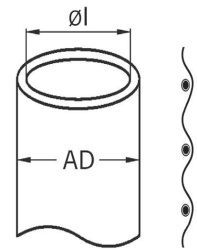

Kunststoff Schutzschlauch flüssigkeitsdicht AIRflex®-KUW-PU-AS Metallic-Blau				Synthetic protective conduit liquid-tight AIRflex®-KUW-PU-AS Metallic blue			
AD mm	ø1 mm	R±10% stat mm	R±10% dyn mm	Hülse Douille/Bush	Art.-Nr.   Art. No.		
10	7	8	20	5020.030.007	2040.701.007	50	
14	10	10	25	5020.030.009	2040.701.010	50	
17	13	13	35	5020.030.011	2040.701.013	50	
19	15	15	40	5020.030.013	2040.701.015	50	
21	16	17	45	5020.030.016	2040.701.016	50	
27	22	20	50	5020.030.021	2040.701.021	50	
36	29	25	65	5020.030.029	2040.701.029	25	
45	38	36	90	5020.030.036	2040.701.038	25	
56	48	40	100	5020.030.048	2040.701.048	25	



# Kunststoff Schutzschlauch flüssigkeitsdicht

## Synthetic protective conduit liquid-tight

AIRflex®-GRS | AIRflex®-GRS

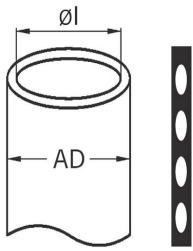

**Material:** PVC mit Hartkunststoffwendel  
**Eigenschaften:** Flexibel, luft- und flüssigkeitsdicht, weitgehend säure- und ölbeständig, silikon- und cadmiumfrei, innen und aussen glatt, leichtes Einziehen von Kabeln und aussen leichtes Reinigen des Schlauches

**Einsatzbereich:** Maschinen- und Anlagenbau, Fahrzeugbau, Schiffsbau, Automation, Elektroanlagen

**Schutzart:** IP 68  
**Einsatztemperatur:** -25°C / +90°C / ^ +100°C

**Material:** PVC with helix of rigid plastic  
**Properties:** Flexible, air and liquid tight, widely resistant to acids and oil, free from silicone and cadmium, smooth inside and outside, easy pulling in of cables, easy cleaning of the conduit

**Application:** Machine and plant constructions, vehicle construction, shipbuilding, automation, electrical installations

**Protection class:** IP 68  
**Temperature range:** -25°C / +90°C / ^ +100°C





Kunststoff Schutzschlauch flüssigkeitsdicht  
 AIRflex®-GRS  
 Grau

Synthetic protective conduit liquid-tight  
 AIRflex®-GRS  
 Grey



AD mm	øl mm	R±10% stat mm	R±10% dyn mm	Hülse Douille/Bush	Art.-Nr.   Art. No.	
14	10	50	125	5020.030.009	0220.101.010	50
17	13	65	165	5020.030.011	0220.101.013	50
21	16	75	190	5020.030.016	0220.101.016	50
27	21	90	225	5020.030.021	0220.101.021	50
36	29	130	325	5020.030.029	0220.101.029	25
45	38	190	475	5020.030.036	0220.101.038	25
56	48	250	625	5020.030.048	0220.101.048	25



EMV Metallschutzschlauch nicht flüssigkeitsdicht Metal protective EMC conduit non liquid-tight	 89 - 90	1
EMV Metallschutzschlauch flüssigkeitsdicht Metal protective EMC conduit liquid-tight	 91 - 92	2

1

2

3

4

5

6

7

8

9

10

11

12

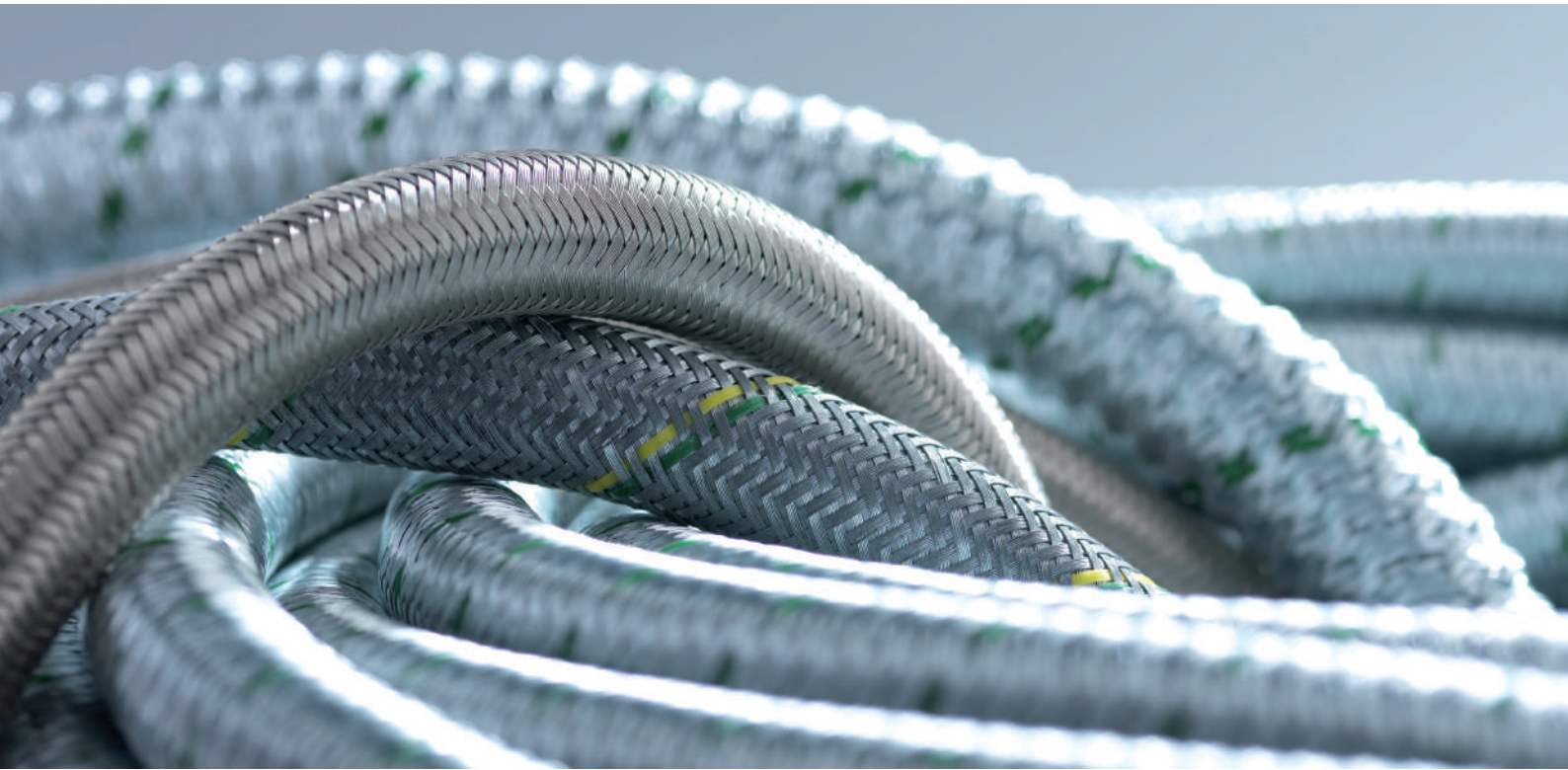

Die **elektromagnetische Verträglichkeit (EMV)** im industriellen Umfeld besitzt einen besonderen Stellenwert, da gerade komplexe Maschinen und Anlagen äusserst anfällig für elektromagnetische Störungen sind. Den unerwünschten EMV-Effekten lässt sich jedoch mit einer wirkungsvollen Schirmung aller Komponenten entgegensteuern. Eine gute Schirmung reduziert einerseits die Störaussendung eines elektrischen Betriebsmittels und verringert gleichzeitig dessen Anfälligkeit für elektromagnetische Beeinträchtigungen.

Störströme beeinflussen Kabel, indem sie auf dem Innenleiter des Kabels eine Störspannung erzeugen. Die Aufgabe des geschirmten Kabels mit dem **EMV Metallschutzschlauch** ist es, diese Störströme abzuleiten und auf Masse zu führen. Datenleitungen werden vor elektromagnetischen Einflüssen abgeschirmt und gleichzeitig die Leitung vor Bruch oder Beschädigung geschützt.

### Wichtigste Eigenschaften

- Hochflexibel
- Zugfest und querdruckbelastbar
- Für schwere mechanische Beanspruchung
- Sehr gute Schirmdämpfung
- Metallschlauch mit und ohne Ummantelung geeignet für den Einsatz im Ex-Bereich
- Gute Laugen- und Säurenbeständigkeit
- Geprüft nach EN / IEC 61386-23

In the industrial sector, **electromagnetic compatibility (EMC)** plays a particularly important role because complex machines and systems are extremely susceptible to electromagnetic interference. Such undesired EMC effects, however, can be counteracted with the effective shielding of all components. Good shielding not only reduces the amount of interference emitted by electrical equipment; at the same time it also reduces the equipment's susceptibility to impaired performance due to electromagnetic effects.

Interference currents have an effect on cables because they generate an interference voltage on the cable's inner conductor. The task of a cable shielded with an **EMC metal conduit** is to bleed this interference current off to ground. Data lines are shielded from electromagnetic effects and at the same time are protected from breakage or damage.

### Key properties

- Extremely flexible
- Withstands high tensile stress and is crush-resistant
- Designed to handle heavy mechanical loads
- Excellent shield attenuation
- High resistance to acids and alkaline substances
- Tested to EN / IEC 61386-23
- Metal conduit with and without sheathing suitable for use in Ex environments

# EMV Metallschutzschlauch nicht flüssigkeitsdicht

## Metal protective EMC conduit non liquid-tight

SPR-EDU-AS | SPR-EDU-AS

Material:	Stahl verzinkt	Material:	zinc coated steel
Außenmantel:	Stahldraht verzinkt	Sheathing:	Galvanized steel wire
Eigenschaften:	Erhöhter mechanischer Schutz durch hohe Zugfestigkeit, hohe Verdrehungsfestigkeit, hohe Biegefestigkeit, hochflexibel, kein Aufdrehen des Schlauches	Properties:	Provides high mechanical protection due to high tensile, torsional and bending strength, highly flexible, no untwisting of the conduit
Anwendung:	Für schwere mechanische Beanspruchung nach DIN 49012, Bauform K, geeignet für den Einsatz im Ex-Bereich nach EN 1127-1	Application:	For heavy mechanical stress acc. to DIN 49012, type K, suitable for application in Ex-area according to EN1127-1
Schirmdämpfung:	10 KHz = 30 dB	Screening attenuation:	10 KHz = 30 dB
Einsatzbereich:	Maschinen- und Anlagenbau, Fahrzeugbau, Schiffsbau, Automation, Elektroanlagen, EMV Anwendungen	Application:	Machine and plant constructions, vehicle construction, shipbuilding, automation, electrical installations, EMC applications
Geprüft nach:	EN / IEC 61386-23	Tested acc. to:	EN / IEC 61386-23
Schutzart:	IP 40	Protection class:	IP 40
Einsatztemperatur:	-50°C / +250°C	Temperature range:	-50°C / +250°C

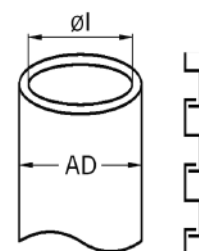

EMV Metallschutzschlauch nicht flüssigkeitsdicht SPR-EDU-AS					Metal protective EMC conduit non liquid-tight SPR-EDU-AS		
AD mm	ø1 mm	R±10% stat mm	R±10% dyn mm	Hülse Douille/Bush	Art.-Nr.   Art. No.		
10	7	16	40	5031.028.007	4010.111.007	50	
14	10	22	55	5031.028.009	4010.111.010	50	
17	13	30	75	5031.028.011	4010.111.013	50	
19	15	32	80	5031.028.013	4010.111.015	50	
21	17	38	95	5031.028.016	4010.111.017	50	
27	22	45	115	5031.028.021	4010.111.022	50	
36	29	65	160	5031.028.029	4010.111.029	25	
45	38	80	200	5031.028.036	4010.111.038	25	
56	49	100	250	5031.028.048	4010.111.049	25	

Technischer Hinweis  
Für EMV-Anwendungen Messingdruckring erforderlich!

Technical note  
For EMC applications brass thrust collar necessary!





# EMV Metallschutzschlauch nicht flüssigkeitsdicht

## Metal protective EMC conduit non liquid-tight

FLEXAgraff®-CU-AS | FLEXAgraff®-CU-AS

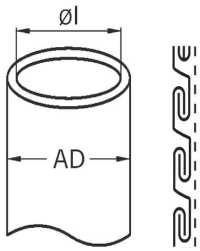

Material:	Stahl verzinkt, doppelt gefalzt	Material:	Steel galvanized, double-overlapped
Umflechtung:	Kupfer verzinkt	Braiding:	Tinned copper
Eigenschaften:	Erhöhte Zug- und Verdrehungsfestigkeit, kein Aufdrehen des Schlauches, sehr flexibel	Properties:	High torsional and tensile strength, no untwisting of the conduit, very flexible
Anwendung:	Geeignet für den Einsatz im Ex-Bereich nach EN 1127-1	Application:	Suitable for application in Ex-environments acc. to EN 1127-1
Schirmdämpfung:	Abschirmfaktor bis 30 MHz. Bis 80 dB nach EN 50289-1-6	Screening attenuation:	Shielding factor up to 30 MHz. Up to 80 dB according to EN 50289-1-6
Einsatzbereich:	Maschinen- und Anlagenbau, Fahrzeugbau, Schiffsbau, Schienenfahrzeuge, Automation, Elektroanlagen, EMV Anwendungen	Application:	Machine and plant constructions, vehicle construction, shipbuilding, railway, automation, electrical installations, EMC applications
Geprüft nach:	EN / IEC 61386-23	Tested acc. to:	EN / IEC 61386-23
Schutzart:	IP 40	Protection class:	IP 40
Einsatztemperatur:	-50°C / +250°C	Temperature range:	-50°C / +250°C



EMV Metallschutzschlauch nicht flüssigkeitsdicht FLEXAgraff®-CU-AS					Metal protective EMC conduit non liquid-tight FLEXAgraff®-CU-AS		
AD mm	øl mm	R±10% stat mm	R±10% dyn mm	Hülse Douille/Bush	Art.-Nr.   Art. No.		
10	7	40	100	5031.028.007	4110.701.007	25	
14	11	50	125	5031.027.009	4110.701.011	25	
17	13	60	150	5031.028.011	4110.701.013	25	
19	15	65	170	5031.028.013	4110.701.015	25	
21	17	70	175	5031.028.016	4110.701.017	25	
27	23	90	225	5031.040.021	4110.701.023	25	
36	29	130	325	5031.028.029	4110.701.029	10	
45	38	150	375	5031.028.036	4110.701.038	10	
56	49	210	525	5031.028.048	4110.701.049	10	

Technischer Hinweis: Für EMV-Anwendungen Messingdruckring erforderlich!  
 Technical note: For EMC applications brass thrust collar necessary!

# EMV Metallschutzschlauch flüssigkeitsdicht

## Metal protective EMC conduits liquid-tight

FLEXAgraff®-CU-PU-AS | FLEXAgraff®-CU-PU-AS

Material:	Stahl-Kaltband DC03 nach EN 10139, verzinkt, doppelt gefalzt, Umflechtung Kupfer verzinkt	Material:	Cold strip DC03 acc. to EN 10139 galvanized, double-overlapped, tinned copper wire braiding
Außenmantel:	Polyurethan	Sheathing:	Polyurethane
Eigenschaften:	Erhöhte Zug- und Verdrehungs-festigkeit, flüssigkeitsdicht, absolut öl-, benzin- und fettbe-ständig, weitgehend lösungs-mittel- und säurebeständig, halogen-, silikon- und cadmi-umfrei	Properties:	High torsional and tensile strength, liquid-proof, absolu-tely resistant to oil, petrol and grease, widely resistant to sol-vents and acids, free of halo-gen, silicone and cadmium
Anwendung:	Für hohe zug- und verdrehungs-beanspruchte, flüssigkeitsdichte Installationen	Application:	For installations requiring high tensile strength, torsional re-sistance and liquid-proofness
Schirmdämpfung:	Abschirmfaktor bis 30 MHz. Bis 80 dB nach EN 50289-1-6	Screening attenuation:	Shielding factor up to 30 MHz. Up to 80 dB according to EN 50289-1-6
Einsatzbereich:	Maschinen- und Anlagenbau, Fahrzeugbau, Schiffsbau, Schie-nenfahrzeuge, Automation, Elektroanlagen, EMV Anwen-dungen	Application:	Machine and plant construc-tions, vehicle construction, shipbuilding, railway, auto-mation, electrical installations, EMC applications
Geprüft nach:	EN / IEC 61386-23	Tested acc. to:	EN / IEC 61386-23
Schutzart:	IP 68	Protection class:	IP 68
Einsatztemperatur:	-50°C / +100°C / ^ +130°C	Temperature range:	-50°C / +100°C / ^ +130°C

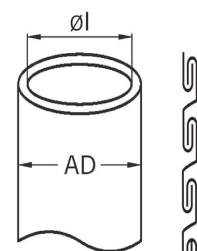

EMV Metallschutzschlauch flüssigkeitsdicht  
FLEXAgraff®-CU-PU-AS  
Grün

Metal protective EMC conduits liquid-tight  
FLEXAgraff®-CU-PU-AS  
Green

AD mm	ø1 mm	R±10% stat mm	R±10% dyn mm	Hülse Douille/Bush	Art.-Nr.   Art. No.	
14	11	50	125	5031.027.009	2540.707.011	25
17	13	60	150	5031.028.011	2540.707.013	25
21	17	70	175	5031.028.016	2540.707.017	25
27	23	90	225	5031.040.021	2540.707.023	25
36	29	130	325	5031.028.029	2540.707.029	10
45	38	150	375	5031.028.036	2540.707.038	10
56	49	210	525	5031.028.048	2540.707.049	10

Technischer Hinweis

Technical note

Für EMV-Anwendungen Messingdruckring erforderlich!

For EMC applications brass thrust collar necessary!



# EMV Metallschutzschlauch flüssigkeitsdicht

## Metal protective EMC conduits liquid-tight

AIRflex®-KUW-EDU | AIRflex®-KUW-EDU

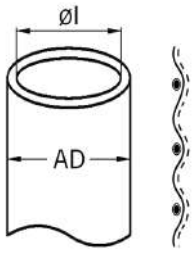

Material:	PVC-Aussenmantel, Innenwendel Federstahldraht PVC-ummantelt	Material:	Soft PVC jacket, helix of PVC sheathed spring steel wire
Aussenmantel:	Stahldraht verzinkt	Sheathing:	Galvanized steel wire
Eigenschaften:	Sehr flexibel, luft- und flüssigkeitsdicht, zug- und verdrehfest, weitgehend öl- und säurebeständig, silikon- und cadmiumfrei, erhöhte Innendruckbeständigkeit, Schutz gegen heisse Späne, gute Abschirmung, innerer Korrosionsschutz durch PVC-ummantelten Federstahldraht	Properties:	Very flexible, airtight and liquid-proof, resistant to stretch and twist, widely resistant to oil and acids, free of silicone and cadmium, high internal resistance to compression, protection against hot swarf, good shielding properties, inside protection against corrosion due to the PVC-sheathed spring steel wire
Anwendung:	Für flexible, flüssigkeitsdichte Installationen an Maschinen und Anlagen, im Bereich von heissen Spänen	Application:	For flexible, liquid-proof installations on machines and plants, for use in areas with hot swarf
Schirmdämpfung:	48dB bei 130MHz, Mittelwert 20dB	Screening attenuation:	48dB at 130MHz, mean value 20dB
Einsatzbereich:	Maschinen- und Anlagenbau, Fahrzeugbau, Schiffsbau, Automation, Elektroanlagen, EMV Anwendungen	Application:	Machine and plant constructions, vehicle construction, shipbuilding, automation, electrical installations, EMC applications
Schutzart:	IP 68	Protection class:	IP 68
Einsatztemperatur:	-25°C / +90°C / ^ +100°C	Temperature range:	-25°C / +90°C / ^ +100°C



EMV Kunststoffschutzschlauch flüssigkeitsdicht AIRflex®-KUW-EDU					Synthetic protective EMC conduit liquid-tight AIRflex®-KUW-EDU	
AD mm	øl mm	R±10% stat mm	R±10% dyn mm	Hülse Douille/Bush	Art.-Nr.   Art. No.	
14	9	16	40	5031.028.009	4230.101.009	50
17	12	19	50	5031.035.011	4230.101.012	50
21	15	24	60	5031.035.016	4230.101.015	50
27	20	30	75	5031.035.021	4230.101.020	50
36	28	40	100	5031.028.029	4230.101.028	25
45	37	48	120	5031.035.036	4230.101.037	25
56	48	60	150	5031.035.048	4230.101.048	25

Technischer Hinweis: Für EMV-Anwendungen Messingdruckring erforderlich!

Technical note: For EMC applications brass thrust collar necessary!



AGRO Kombi-Schlauchverschraubung Progress® Messing erhöhte Sicherheit Ex e II  
AGRO combination conduit gland Progress® nickel-plated brass increased safety Ex e II



98

Metallschutzschlauch mit und ohne Umflechtung  
Metal protective conduit with and without braiding

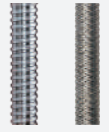

99 - 102

- 1
- 2
- 3
- 4
- 5
- 6**
- 7
- 8
- 9
- 10
- 11
- 12

## Ex Kombi-Schlauchverschraubung und Schutzschläuche aus Metall

### Ex combination conduit gland and protective conduits made of metal

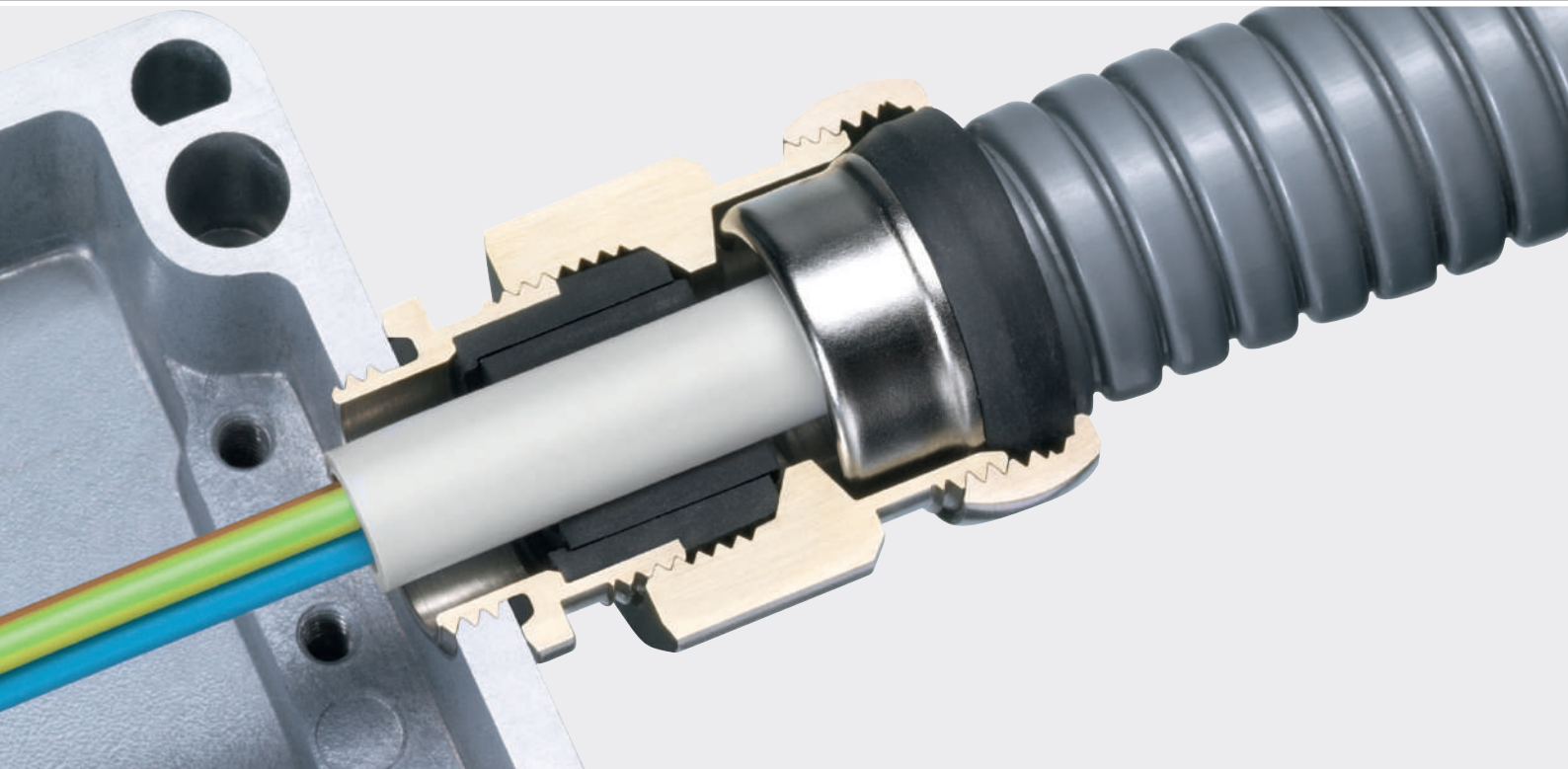

In vielen Bereichen wie zum Beispiel der Chemischen Industrie, Lackierereien, Offshore, Raffinerien, Tankstellen, Textil- und Papierindustrie, Nahrungsmittelindustrie, Glas- und/oder Keramikindustrie, Holzverarbeitung und in vielen weiteren Industrien, werden Geräte in explosionsgefährdeten Bereichen betrieben. Aufgrund der hohen Gefährdung von Personen sowie Sachwerten im Falle einer Explosion gelten speziell in explosionsgefährdeten Bereichen besonders strenge rechtliche und technische Anforderungen.

AGRO Kombi-Schlauchverschraubungen sind eine optimale Kombination, wenn Sie Kabel in einem Schutzschlauch in ein Gehäuse einführen wollen und gleichzeitig eine sichere Abdichtung und Zugentlastung des Kabels möchten.

#### **Dichtheit**

Mit der integrierten Kabelverschraubung erzielen Sie eine hervorragende Dichtheit (IP68) im Innenbereich des Schutzschlauchs. So verhindern Sie eindringen von Wasser und Kondenswasser.

#### **Wichtigste Eigenschaften**

- IECEx Zertifikat
- Zugfest und querdruckbelastbar
- Für schwere mechanische Beanspruchung
- Metallschlauch mit und ohne Ummantelung geeignet für den Einsatz im Ex-Bereich

In many areas – such as in the chemical industry, paint shops, offshore facilities, refineries, filling stations, the textile and paper industry, foodstuffs industry, glass and ceramics industry, wood processing and in many other industries – equipment is operated in potentially explosive atmospheres. Due to the high risks to personnel and property in case of an explosion, particularly strict legal and technical requirements are applicable in potentially explosive atmospheres.

AGRO combination conduit glands provide an optimal combination if you want to feed cables inside a conduit into an enclosure and at the same time want a secure seal and strain relief for the cables.

#### **Sealing capability**

The integrated cable gland achieves excellent sealing (IP68) inside the conduit. In this way, you make certain that water and condensate cannot make its way inside.

#### **Key properties**

- IECEx certificate
- Withstands high tensile stress and is crush-resistant
- Designed to handle heavy mechanical loads
- Metal conduit with and without braided suitable for use in Ex environments



### Richtlinien & Vorschriften

Das Thema **Explosionsschutz** sollte im Bewusstsein von all jenen sein, die beruflich mit Industrieanlagen zu tun haben.

In vielen Industrien entstehen oder entweichen bei der Herstellung, Verarbeitung, dem Transport und der Lagerung von brennbaren Stoffen Gase, Dämpfe oder Nebel, die an die Umgebung freigegeben werden. In anderen Prozessen entstehen brennbare Stäube. In Verbindung mit dem Sauerstoff der Luft kann eine explosionsfähige Atmosphäre entstehen, welche bei einer Entzündung zu einer Explosion führt.

Weltweit ist der Explosionsschutz durch die Regierungen der einzelnen Staaten gesetzlich geregelt. Länderspezifische Unterschiede in den technischen Anforderungen und den geforderten Zulassungen für explosionsgeschützte Geräte stellen hohe Anforderungen vor allem für global operierende Hersteller dar und erfordern einen hohen Entwicklungs- und Zulassungsaufwand.

Im Zuge der Globalisierung konnten grosse Fortschritte hinsichtlich einheitlicher Richtlinien für den Explosionsschutz erzielt werden.

#### Richtlinie 2014/34/EU

Neu ist die Richtlinie 2014/34/EU des Europäischen Parlamentes und des Rates vom 26. Februar 2014 zur Harmonisierung der Rechtsvorschriften die Basis, welche für Hersteller und Benutzer von Geräten oder Schutzsystemen für den Einsatz in explosionsgefährdeten Bereichen verbindlich ist.

Nach zweijähriger Übergangsfrist dürfen ab dem 20.04.2016 nur noch Produkte gemäss den neuen Richtlinien und entsprechender EU-Konformitätserklärung auf den Markt gebracht werden. Zertifikate nach Richtlinie 94/9/EG behalten ihre Gültigkeit. Eine Neuzertifizierung nach den aktuellen Richtlinien 2014/34/EU ist nicht erforderlich.

### Voraussetzungen für eine Zertifizierung

Die Richtlinie 2014/34 EU definiert im Anhang verschiedene Module für die Inverkehrbringung von Geräten für den Einsatz in explosionsgefährdeten Bereichen. Die Module III und IV werden oft verwendet, woraus zwei Zertifikate resultieren:

- Die **EU-Baumusterprüfbescheinigung**
- Die **Anerkennung Qualitätssicherung Produktion**

Beide Zertifikate werden von akkreditierten Prüfstellen nach erfolgreich absolvierten Prüfungen/Audits ausgestellt.

#### EU-Baumusterprüfbescheinigung

Modul B regelt die EU-Baumusterprüfung. Darauf basiert die EU-Baumusterprüfbescheinigung. Sie wird auf Grund der erfolgreichen technischen Produktprüfungen ausgestellt.

#### Anerkennung Qualitätssicherung Produktion

Modul D fordert die geprüfte und überwachte Produktion. Sie stellt sicher, dass die in Verkehr gebrachten Produkte mit den Prüfmustern der EU-Baumusterprüfbescheinigung übereinstimmen. Ein vorhandenes QM-System wird nach EN/ISO/IEC 80079-34 geprüft und zertifiziert.

#### EU-Konformitätserklärung

Die EU-Konformitätserklärung basiert auf der EU-Baumusterprüfbescheinigung und der Mitteilung Qualitätssicherung Produktion. Damit erklärt der Hersteller die Einhaltung der geltenden Normen, Richtlinien und Vorschriften. Sichtbar wird dies durch die CE-Kennzeichnung.

### Directives & Regulations

Anyone who is involved professionally with industrial systems must now be very conscious about the topic of explosion protection. In many industries, gases, vapours or mists build up or escape during the manufacture, processing, transport or storage of combustible materials, and these are released into the environment. Combustible dust is created in other processes. When these are combined with oxygen in the air, a hazardous atmosphere can build up which if ignited results in an explosion.

Explosion protection is governed by the legislation of individual countries around the world. Differences in technical requirements specific to each country and the required permits for explosion-proof equipment place high requirements on manufacturers, especially those with global operations, and these result in high costs for product development and approvals processes. In the wake of globalisation, though, it has been possible to make great strides towards uniform policies for explosion protection.

#### Directive 2014/34 EC

The new directives 2014/34/EC of the European Parliament and of the Council of 26 February 2014 on the harmonisation of the laws of the Member States address manufacturers and users of equipment and protective systems for use in potentially explosive atmospheres.

Since 20 April 2016 only products approved according to the new directions and with EC declaration of conformity can be brought to the market. The old certificates according to the former directives 94/9/EC remain valid. A recertification according to the directives 2014/34/EU is not necessary.

### Prerequisites for certification

In the annex of directives 2014/34 EC various modules for the commercialisation of equipment intended for use in potentially explosive atmospheres are defined. Modules III and IV are often used and applied at AGRO as well, and from them two certificates result:

- **EC type-examination certificate**
- **Recognition of production quality assurance**

Both certificates are issued by accredited testing facilities after tests have been successfully completed.

#### EC type-examination certificate

The EC type-examination certificate is the document which is issued on the base of successfully passed technical testing according to the requirements of module B.

#### Recognition of production quality assurance

Module D demands tested and monitored production. It ensures that products placed on the market are identical with the test samples used for the EC type-examination certificate. The quality management system must be tested and certified according to EN/ISO/IEC 80079-34.

#### CE declaration of conformity

The CE declaration of conformity is based on the EC type-examination certificate and QS approval. With it, a manufacturer declares that it has observed all applicable standards, instructions and regulations. This is made visible with the CE symbol, which is a part of the marking.

# Generelle Informationen Explosionsschutz

## Information about explosion protection

### Bedingungen für eine Explosion

Damit Explosionen in atmosphärischer Luft stattfinden, müssen in der Regel drei Faktoren zusammenkommen:

- brennbarer Stoff
- Sauerstoff (Luft)
- Zündquelle

Die ersten beiden Faktoren - brennbarer Stoff und Luft - müssen in einem entsprechenden Mengenverhältnis vorhanden sein, damit sie eine explosionsfähige Atmosphäre bilden können.

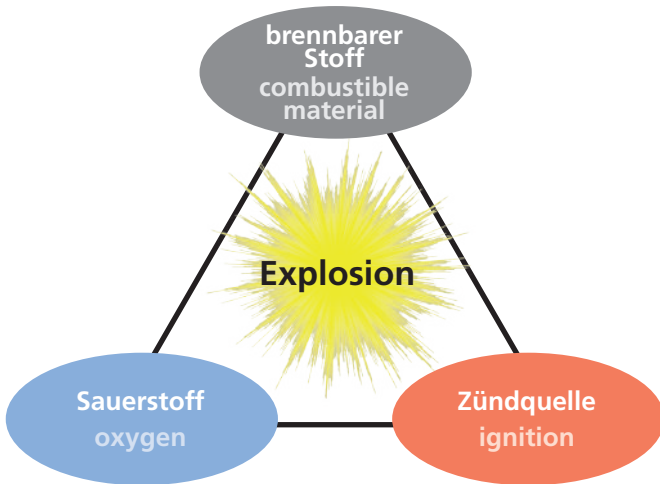

### Conditions for an explosion

As a rule, an explosion can only take place in atmospheric air if three factors come together:

- a combustible material
- oxygen (in the air)
- ignition source

The first two factors – flammable material and air – must be present in a corresponding concentration so that they can form an explosive atmosphere.

### Beispiele für Zoneneinteilungen im Ex-Bereich

Examples for zone classifications in hazardous environments

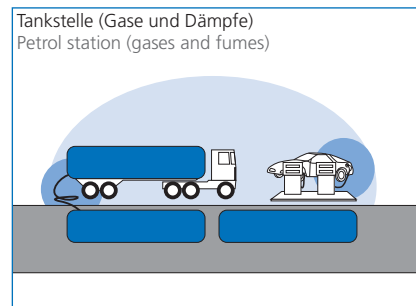

- Zone 0
- Zone 1
- Zone 2

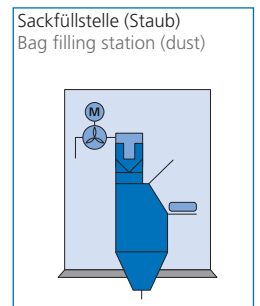

- Zone 20
- Zone 21
- Zone 22

### Welche Schutzmassnahmen verringern die Gefahr einer Explosion?

- Vermeidung brennbarer Stoffe
- Inertisierung (Zugabe von Stickstoff, Kohlendioxid usw.)
- Konzentrationen begrenzen
- Verbesserte Belüftung
- Sekundärer Explosionsschutz ist erforderlich, wenn Explosionsgefahr durch primäre Explosionsschutz-Massnahmen nicht auszuschliessen ist.

### What protective measures can be taken to reduce the danger of explosion?

- avoid combustible substances
- inerting (addition of nitrogen, carbon dioxide, etc.)
- limiting concentration levels
- improved ventilation
- secondary explosion protection is necessary if the danger of explosion cannot be ruled out through primary explosion protection measures

Zoneneinteilung / Zone classification						
	Gas / gas			Staub / dust		
	Zone 0	Zone 1	Zone 2	Zone 20	Zone 21	Zone 22
Häufigkeit der Explosionsgefahr frequency of explosion risk	ständig oder langfristig always or long-term	gelegentlich casual	selten und kurzfristig rare and for a short time	wie Zone 0 Staubablagerungen allein bilden keine Zone 20 like zone 0 dust deposit alone is not generate zone 20	wie Zone 1 like zone 1	wie Zone 2 oder wenn Staubanhebungen vorhanden sind like zone 2 or if dust deposit occurs
Häufigkeit der Zündquellen von elektrischen Betriebsmitteln frequency sources of ignition in electrical equipment	niemals (auch nicht bei seltenen Betriebsstörungen) never (also not on rare breakdowns)	sehr selten (auch nicht bei häufiger zu erwartenden Betriebsstörungen) very rare (also not on frequently expected disturbances)	gelegentlich (z.B. bei Betriebsstörung) casual (e.g. on disturbances)	wie Zone 0 like zone 0	wie Zone 1 like zone 1	wie Zone 2 like zone 2

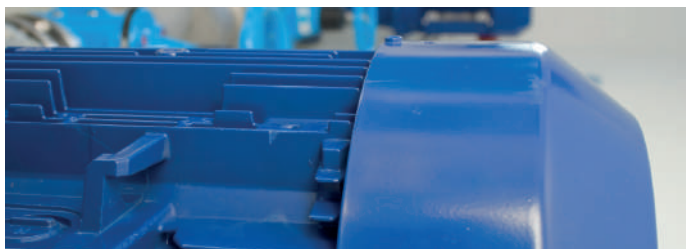

### Explosionsgruppen

Bei den Explosionsgruppen wird zunächst zwischen Gerätegruppe I und Gerätegruppe II von Betriebsmitteln unterschieden:

Elektrische Betriebsmittel der Gerätegruppe I werden für den schlagwettergefährdeten Grubenbau verwendet.

Für die elektrischen Betriebsmittel der Gerätegruppe II wird eine weitere Unterteilung in Explosionsgruppen vorgenommen. Die Unterteilung ist abhängig von der Grenzspaltweite (MESG) und dem Mindestzündstromverhältnis.

Elektrische Betriebsmittel mit der Zulassung für die Explosionsgruppe IIC dürfen auch in den Explosionsgruppen IIA und IIB eingesetzt werden. Elektrische Betriebsmittel der Gerätegruppe III werden ebenfalls in weitere Explosionsgruppen unterteilt.

### Explosion groups

Within the explosion groups, for electrical equipment a first distinction is made between Equipment Group I and Equipment Group II. Electrical equipment in Equipment Group I is used for mines susceptible to firedamp.

For electrical equipment in Equipment Group II, a further subdivision is made into explosion groups. The subdivision depends on the maximum experimental safe gap (MESG) and the minimum ignition current.

Electrical equipment with approval for Explosion Group IIC can also be used in Explosion Groups IIA and IIB. Electrical equipment in Equipment Group III is likewise subdivided into further explosion groups.

Explosionsgruppen   Explosion groups				
Gerätegruppe Equipment group	Verwendungsbeispiele Application examples	Gas-/ Staubgruppe Gas/dust group	Explosionsgruppe Explosion group	
<b>Gruppe I</b>	Elektrische Betriebsmittel für schlagwettergefährdete Grubenbaue → Schlagwetterschutz Ex ...I			
<b>Group I</b>	Electrical equipment for mines susceptible to firedamp → Firedamp protection Ex ...I			
<b>Gruppe II</b>	Elektrische Betriebsmittel für Bereiche, die durch explosive Gase gefährdet sind. → Explosionsschutz Ex ...II	IIA (z.B. Propan)	IIA	> 0.9 mm
		IIB (z.B. Ethylen)	IIB	0.5 bis / up to 0.9 mm
		IIC (z.B. Wasserstoff)	IIC	< 0.5 mm
<b>Group II</b>	Electrical equipment for areas which are hazardous due to explosive gases Explosion protection Ex...II	IIA (e.g. propane)	IIA	> 0.9 mm
		IIB (e.g. ethylene)	IIB	0.5 bis / up to 0.9 mm
		IIC (e.g. hydrogen)	IIC	< 0.5 mm
<b>Gruppe III</b>	Elektrische Betriebsmittel für Bereiche, die durch explosive Stäube gefährdet sind. → Explosionsschutz Ex ...III	IIIA (z.B. brennbare Flocken)	IIIA	
		IIIB (z.B. nicht leitfähiger Staub)	IIIB	
		IIIC (z.B. leitfähiger Staub)	IIIC	
<b>Group III</b>	Electrical equipment for areas which are hazardous due to explosive dust Explosion protection Ex ...III	IIIA (e.g. combustible flakes)	IIIA	
		IIIB (e.g. non-conductive dust)	IIIB	
		IIIC (e.g. conductive dust)	IIIC	

Für elektrische Betriebsmittel der Gruppe II wird weiter eine Unterteilung in Explosionsgruppen und Temperaturklassen vorgenommen.

For Group II equipment a further subdivision is made into explosion groups and temperature classes.

Einteilung in Temperaturklassen Assignment in temperature classes		
Temperaturklasse Temperature class	Zündtemperatur Ignition temperature	Max. Oberflächentemperatur   Max. surface temperature
T1	≥ 450 °C	450 °C
T2	300-450 °C	300 °C
T3	200-300 °C	200 °C
T4	135-200 °C	135 °C
T5	100-135 °C	100 °C
T6	85-100 °C	85 °C



# AGRO Kombi-Schlauchverschraubungen Progress® Messing erhöhte Sicherheit Ex e II

## AGRO combination conduit glands Progress® nickel-plated brass increased safety Ex e II

### Kurzes Anschlussgewinde metrisch | Short entry thread metric

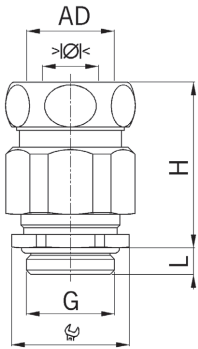

Material: Messing vernickelt  
 Dichtung: TPE  
 O-Ring : FPM  
 Einsatztemperatur: -60°C / +100°C  
 Schutzart: IP 66 / IP 68  
 Prüfnorm: IEC EN 60079-0  
 IEC EN 60079-7  
 IEC EN 60079-31  
 Gas: II 2G Ex eb IIC Gb  
 Staub: II 2D Ex tb IIIC Db  
 Zone: Gas 1 und 2 / Staub 21 und 22  
 Zertifikat: SEV 15 ATEX 0152X

IECEx Zertifikat: IECEx SEV 15.0019X

Material: Nickel-plated brass  
 Seal: TPE  
 O-ring : FPM  
 Temperature range: -60°C / +100°C  
 Protection class: IP 66 / IP 68  
 Test standard: IEC EN 60079-0  
 IEC EN 60079-7  
 IEC EN 60079-31  
 Gas: II 2G Ex eb IIC Gb  
 Dust: II 2D Ex tb IIIC Db  
 Zone: Gas 1 and 2 / dust 21 and 22  
 Certificate: SEV 15 ATEX 0152X

IECEx Certificate: IECEx SEV 15.0019X

### Progress MS Kombi EX



Einteiliger Dichteinsatz  
 nicht durchgehend isolierend

One-piece sealing insert  
 not overall length insulated

G	AD mm	>Ø< min mm	>Ø< max mm	 mm	H mm	L mm	Art.-Nr.   Art. No.	
M12x1.5	10	4.0	6.5	15/17	33	5	EX1700.12.10.065	50
M16x1.5	14	4.5	6.0	18/21	38	5	EX1700.17.14.060	50
M16x1.5	14	6.0	8.0	18/21	38	5	EX1700.17.14.080	50
M16x1.5	14	8.5	10.5	18/21	38	5	EX1700.17.14.105	50
M20x1.5	17	6.5	8.0	24/25	38	6	EX1700.20.17.080	25
M20x1.5	17	9.5	11.0	24/25	38	6	EX1700.20.17.110	25
M20x1.5	19	6.5	8.0	24/27	39	6	EX1700.20.19.080	25
M20x1.5	19	9.5	11.0	24/27	39	6	EX1700.20.19.110	25
M20x1.5	19	12.0	15.0	24/27	39	6	EX1700.20.19.150	25
M20x1.5	21	6.5	8.0	24/29	39	6	EX1700.20.21.080	25
M20x1.5	21	9.5	11.0	24/29	39	6	EX1700.20.21.110	25
M20x1.5	21	12.0	15.0	24/29	39	6	EX1700.20.21.150	25
M25x1.5	21	10.5	12.5	30/29	43	7	EX1700.25.21.125	25
M25x1.5	21	13.0	16.0	30/29	43	7	EX1700.25.21.160	25
M25x1.5	27	10.5	12.5	30/36	50	7	EX1700.25.27.125	25
M25x1.5	27	13.0	16.0	30/36	50	7	EX1700.25.27.160	25
M25x1.5	27	17.0	20.5	30/36	50	7	EX1700.25.27.205	25
M32x1.5	27	19.0	21.0	36/36	52	8	EX1700.32.27.210	25
M40x1.5	36	25.0	28.5	45/45	56	8	EX1700.40.36.285	10
M50x1.5	45	35.0	37.0	55/54	60	9	EX1700.50.45.370	10
M63x1.5	56	44.0	46.0	70/66	67	10	EX1700.63.56.460	5

Langes Anschlussgewinde auf Anfrage

Long entry thread available on request

Je nach Schlauchtyp muss die passende Stabilisierungshülse separat bestellt werden.

Depending on the type of conduit, the stabilising bush must be ordered separately.

Achtung: Es dürfen nur metallische oder metallisch umflochtene Schutzschläuche verwendet werden !

Warning: Only metallic conduits or conduits with metallic braiding may be applied !

# Metallschutzschlauch nicht flüssigkeitsdicht für Ex Anwendungen

## Metal protection conduit non liquid-tight for Ex applications

SPR-AS | SPR-AS

Material:	Stahl verzinkt	Material:	zinc coated steel
Eigenschaften:	Hochflexibel, zugfest, querdruckbelastbar	Properties:	Highly flexible, stretch resistant, lateral crush resistant
Anwendung:	Für schwere mechanische Beanspruchung nach DIN 49012, Bauform G, geeignet für den Einsatz im Ex-Bereich nach EN 1127-1	Application:	For heavy mechanical stress acc. to DIN 49012, type G, suitable for application in Ex environment acc. to EN 1127-1
Einsatzbereich:	Maschinen- und Anlagenbau, Fahrzeugbau, Schiffsbau, Automation, Elektroanlagen	Application:	Machine and plant constructions, vehicle construction, shipbuilding, automation, electrical installations
Geprüft nach:	EN / IEC 61386-23	Tested acc. to:	EN / IEC 61386-23
Schutzart:	IP 40	Protection class:	IP 40
Einsatztemperatur:	-50°C / +250°C	Temperature range:	-50°C / +250°C

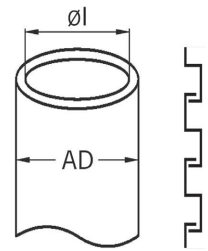

Metallschutzschlauch nicht flüssigkeitsdicht SPR-AS					Protective metal conduit non liquid-tight SPR-AS		
AD mm	øl mm	R±10% stat mm	R±10% dyn mm	Hülse Douille/Bush	Art.-Nr.   Art. No.		
10	8	20	50	5031.027.007	1010.111.008	50	
14	11	28	70	5031.027.009	1010.111.011	50	
17	14	30	75	5031.027.011	1010.111.014	50	
19	16	35	90	5031.027.013	1010.111.016	50	
21	18	40	100	5031.027.016	1010.111.018	50	
27	23	48	120	5031.027.021	1010.111.023	50	
36	31	60	150	5031.027.029	1010.111.031	25	
45	40	82	205	5031.027.036	1010.111.040	25	
56	51	100	250	5031.027.048	1010.111.051	25	





# Metallschutzschlauch nicht flüssigkeitsdicht für Ex Anwendungen

## Metal protection conduit non liquid-tight for Ex applications

SPR-EDU-AS | SPR-EDU-AS

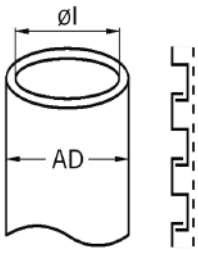

Material:	Stahl verzinkt	Material:	zinc coated steel
Aussenmantel:	Stahldraht verzinkt	Sheathing:	Galvanized steel wire
Eigenschaften:	Erhöhter mechanischer Schutz durch hohe Zugfestigkeit, hohe Verdrehungsfestigkeit, hohe Biegefestigkeit, hochflexibel, kein Aufdrehen des Schlauches	Properties:	Provides high mechanical protection due to high tensile, torsional and bending strength, highly flexible, no untwisting of the conduit
Anwendung:	Für schwere mechanische Beanspruchung nach DIN 49012, Bauform K, geeignet für den Einsatz im Ex-Bereich nach EN 1127-1	Application:	For heavy mechanical stress acc. to DIN 49012, type K, suitable for application in Ex environment acc. to EN1127-1
Schirmdämpfung:	10 KHz = 30 dB	Screening attenuation:	10 KHz = 30 dB
Einsatzbereich:	Maschinen- und Anlagenbau, Fahrzeugbau, Schiffsbau, Automation, Elektroanlagen, EMV Anwendungen	Application:	Machine and plant constructions, vehicle construction, ship-building, automation, electrical installations, EMC applications
Geprüft nach:	EN / IEC 61386-23	Tested acc. to:	EN / IEC 61386-23
Schutzart:	IP 40	Protection class:	IP 40
Einsatztemperatur:	-50°C / +250°C	Temperature range:	-50°C / +250°C



EMV Metallschutzschlauch nicht flüssigkeitsdicht SPR-EDU-AS					Metal protective EMC conduit non liquid-tight SPR-EDU-AS	
AD mm	ØI mm	R±10% stat mm	R±10% dyn mm	Hülse Douille/Bush	Art.-Nr.   Art. No.	
10	7	16	40	5031.028.007	4010.111.007	50
14	10	22	55	5031.028.009	4010.111.010	50
17	13	30	75	5031.028.011	4010.111.013	50
19	15	32	80	5031.028.013	4010.111.015	50
21	17	38	95	5031.028.016	4010.111.017	50
27	22	45	115	5031.028.021	4010.111.022	50
36	29	65	160	5031.028.029	4010.111.029	25
45	38	80	200	5031.028.036	4010.111.038	25
56	49	100	250	5031.028.048	4010.111.049	25

Technischer Hinweis  
Für EMV-Anwendungen Messingdruckring erforderlich!

Technical note  
For EMC applications brass thrust collar necessary!

# Metallschutzschlauch nicht flüssigkeitsdicht für Ex Anwendungen

## Metal protection conduit non liquid-tight for Ex applications

FLEXAgraff®-AS | FLEXAgraff®-AS

Material:	Stahl verzinkt, doppelt gefalzt	Material:	Steel galvanized, double-overlapped
Eigenschaften:	Hohe Zugfestigkeit, hohe Verdrehungsfestigkeit, kein Aufdrehen des Schlauches, sehr flexibel	Properties:	High tensile, torsional- and bending strength, highly flexible, no untwisting of the conduit
Anwendung:	Schutzschlauch u.a. für Hydraulik- und Pneumatikschläuche, geeignet für den Einsatz im Ex-Bereich nach EN 1127-1	Application:	Protective conduit e.g. for hydraulic and pneumatic conduits, suitable for application in Ex environment acc. to EN 1127-1
Einsatzbereich:	Maschinen- und Anlagenbau, Fahrzeugbau, Schiffsbau, Automation, Elektroanlagen	Application:	Machine and plant constructions, vehicle construction, shipbuilding, automation, electrical installations
Geprüft nach:	EN / IEC 61386-23	Tested acc. to:	EN / IEC 61386-23
Schutzart:	IP 40	Protection class:	IP 40
Einsatztemperatur:	-50°C / +250°C	Temperature range:	-50°C / +250°C

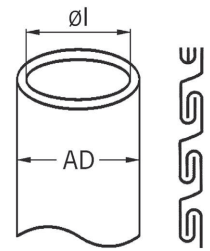

Metallschutzschlauch nicht flüssigkeitsdicht FLEXAgraff®-AS					Protective metal conduit non liquid-tight FLEXAgraff®-AS		
AD mm	Øl mm	R±10% stat mm	R±10% dyn mm	Hülse Douille/Bush	Art.-Nr.   Art. No.		
10	8	40	100	5031.027.007	<b>1080.101.008</b>	50	
14	12	50	125	5031.039.009	<b>1080.101.012</b>	50	
17	14	60	150	5031.027.011	<b>1080.101.014</b>	50	
19	16	67	170	5031.027.013	<b>1080.101.016</b>	50	
21	18	70	175	5031.027.016	<b>1080.101.018</b>	50	
27	24	90	225	5031.039.021	<b>1080.101.024</b>	50	
36	31	130	325	5031.027.029	<b>1080.101.031</b>	25	
45	40	150	375	5031.027.036	<b>1080.101.040</b>	25	
56	51	210	525	5031.027.048	<b>1080.101.051</b>	25	

Auf Anfrage lieferbar: Rostfreier Stahl A2      Available on request: Stainless steel A2



# EMV Metallschutzschlauch nicht flüssigkeitsdicht für Ex Anwendungen

## Metal protection EMC conduit non liquid-tight for Ex applications

FLEXAgraff®-CU-AS | FLEXAgraff®-CU-AS

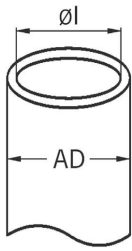

Material:	Stahl verzinkt, doppelt gefalzt	Material:	Steel galvanized, double-overlapped
Umflechtung:	Kupfer verzinkt	Braiding:	Tinned copper
Eigenschaften:	Erhöhte Zug- und Verdrehungsfestigkeit, kein Aufdrehen des Schlauches, sehr flexibel	Properties:	High torsional- and tensile strength, no untwisting of the conduit, very flexible
Anwendung:	Geeignet für den Einsatz im Ex-Bereich nach EN 1127-1	Application:	Suitable for application in Ex-environment acc. to EN 1127-1
Schirmdämpfung:	Abschirmfaktor bis 30 MHz. Bis 80 dB nach EN 50289-1-6	Screening attenuation:	Shielding factor up to 30 MHz. Up to 80 dB according to EN 50289-1-6
Einsatzbereich:	Maschinen- und Anlagenbau, Fahrzeugbau, Schiffsbau, Schienenfahrzeuge, Automation, Elektroanlagen, EMV Anwendungen	Application:	Machine and plant constructions, vehicle construction, shipbuilding, railway, automation, electrical installations, EMC applications
Geprüft nach:	EN / IEC 61386-23	Tested acc. to:	EN / IEC 61386-23
Schutzart:	IP 40	Protection class:	IP 40
Einsatztemperatur:	-50°C / +250°C	Temperature range:	-50°C / +250°C



EMV Metallschutzschlauch nicht flüssigkeitsdicht FLEXAgraff®-CU-AS					Metal protective EMC conduit non liquid-tight FLEXAgraff®-CU-AS		
AD mm	Øl mm	R±10% stat mm	R±10% dyn mm	Hülse Douille/Bush	Art.-Nr.   Art. No.		
10	7	40	100	5031.028.007	4110.701.007	25	
14	11	50	125	5031.027.009	4110.701.011	25	
17	13	60	150	5031.028.011	4110.701.013	25	
19	15	65	170	5031.028.013	4110.701.015	25	
21	17	70	175	5031.028.016	4110.701.017	25	
27	23	90	225	5031.040.021	4110.701.023	25	
36	29	130	325	5031.028.029	4110.701.029	10	
45	38	150	375	5031.028.036	4110.701.038	10	
56	49	210	525	5031.028.048	4110.701.049	10	

Technischer Hinweis: Für EMV-Anwendungen Messingdruckring erforderlich!  
 Technical note: For EMC applications brass thrust collar necessary!



<p>Schlauchverschraubung Messing komplett Complete conduit gland nickel-plated brass</p>	 <b>106 - 109</b>	1
<p>EMV-Schlauchverschraubung Messing komplett Complete EMC conduit gland nickel-plated brass</p>	 <b>110 - 112</b>	2
<p>Schlauchverschraubung Messing mit Innengewinde Conduit gland with internal thread nickel-plated brass</p>	 <b>113</b>	3
<p>Schlauchverschraubung Messing drehbar Swivelling conduit gland nickel-plated brass</p>	 <b>114</b>	4
<p>AGRO Kombi-Schlauchverschraubung Progress® Messing mit integrierter Kabelverschraubung AGRO combination conduit gland Progress® nickel-plated brass with integrated cable gland</p>	 <b>115 - 124</b>	5
<p>AGRO Kombi-EMV-Schlauchverschraubung für Kupfer-Hohlgeflechte AGRO combination EMC conduit gland for copper braidings</p>	 <b>125</b>	6
<p>Schlauchverschraubung Winkel 90° Messing 90° Elbow conduit gland nickel-plated brass</p>	 <b>126</b>	7
<p>Kunststoff Schlauchverschraubungen gerade Synthetic straight conduit gland</p>	 <b>127 - 128</b>	8

# Metall Schlauchverschraubungen

## Metal conduit glands



Die Metall-Schlauchverschraubungen bieten einen hohen Staub- und Flüssigkeitsschutz sowie eine vibrations- und zugfeste Installation. Die kraftschlüssige Verbindung von Schlauch und Verschraubung ergibt eine einwandfreie Erdung. Für EMV-Anwendungen ist der Messing-Druckring einzusetzen.

AGRO Kombi-Schlauchverschraubungen sind eine optimale Kombination, wenn Sie Kabel in einem Schutzschlauch in ein Gehäuse einführen wollen und gleichzeitig eine sichere Abdichtung und Zugentlastung des Kabels möchten.

### Dichtheit

Mit der integrierten Kabelverschraubung erzielen Sie eine hervorragende Dichtheit (IP68) im Innenbereich des Schutzschlauchs. So verhindern Sie eindringen von Wasser und Kondenswasser.

### Wichtigste Eigenschaften

- Messing vernickelt
- Für schwere mechanische Beanspruchung
- Kraftschlüssige Verbindung von Schlauch und Verschraubung

Metal cable glands are dustproof and watertight and offer a vibration-proof and tensile resistant installation.

The friction-locked connection of conduit and gland allows for perfect electrical grounding. For EMC applications a brass thrust collar is necessary.

AGRO Combination conduit glands are an optimal solution if you want to feed cables inside a conduit into an enclosure and at the same time want a secure seal and strain relief for the cables.

### Sealing capability

The integrated cable gland achieves excellent sealing (IP68) inside the conduit. In this way, you make certain that water and condensate cannot make its way inside.

### Key properties

- Nickel-plated brass
- Designed to handle heavy mechanical loads
- The friction-locked connection of conduit and connector





Material:	Gehäuse und Druckmutter Messing vernickelt Standard-Dichtring: Thermoplastisches Elastomer TPE Stabilisierungshülse je nach Schlauchtyp: Messing blank, Messing vernickelt oder Kunst- stoff O-Ring NBR	Material	Housing and thrust collar nickel-plated brass Standard sealing ring: Thermoplastic elastomer TPE Stabilizing bush depending on the type of conduit: Polished brass, nickel-plated brass or synthetics O-ring NBR	1
Eigenschaften:	Sicherheits-Schlauchmontage mit hohem Staub- und Flüssig- keitsschutz, kraftschlüssige Verbindung von Schlauch und Verschraubung. Abdeckung der Schlauchenden. Vibrations- und zugfest.	Properties:	Safe, dustproof, watertight and tensile-resistant connection of conduit gland and conduit. Conduit ends covered. Vibration and tensile-resistant.	2
Schutzart:	In Abhängigkeit der Kombina- tion Schlauch/Verschraubung <b>IP40 bis IP66</b> nach EN 60529.	Protection class	Depending on the combination of conduit and conduit gland protections of <b>IP40 up to IP66</b> acc. to EN 60529 may be reached	3
Einsatztemperatur:	-40°C bis +125°C mit Dichtring aus TPE  -60°C bis +300°C mit Dichtring aus PTFE  -40°C bis +250°C mit Druckring aus Messing (EMV)	Temperature range:	-40°C up to +125°C with sealing ring made of TPE  -60°C up to +300°C with sealing ring made of PTFE  -40°C up to +250°C with thrust collar made of brass (EMC)	4 5
Flüssigkeitsdichte Montage:	Für Einsatz bei hohen Temperaturen bis ca. 300°C anstelle O-Ring Flachdichtung Klinger SIL 4300 verwenden	Liquid-tight assembly:	For high temperature applications up to 300°C use a sealing washer SIL 4300 instead of an O-ring	6
Funktionssicherheit:	Wichtig: nur gewährleistet bei Verwendung der passenden Stabilisierungshülse	Operational reliability:	Important: only when the appropriate stabilizing bush is applied	7
Verwendung:	Optimale Schutzschlauchmontage nach den Anwendungsvorschriften EN 60204 in allen Bereichen des Maschinen- und Anlagenbaus.	Application:	Optimum installation of the protective conduits according to EN 60204 for machine and plant constructions	8

A = Verschraubungsge-  
häuse mit montier-  
tem O-Ring  
Gland body with  
pre-assembled o-ring

B = Stabilisierungshülse  
Stabilizing bush

C = Dichtring oder Mes-  
sing Druckring (zwin-  
gend für EMV-An-  
wendungen)  
Sealing ring or  
brass thrust collar  
(mandatory for EMC  
applications)

D = Druckmutter  
Compression nut

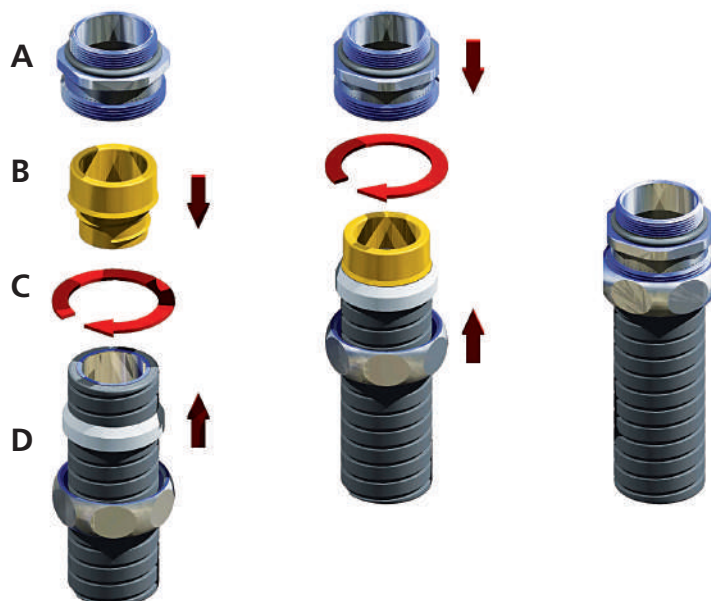

# Schlauchverschraubung Messing komplett

## Complete conduit gland nickel-plated brass

### Anschlussgewinde metrisch | Entry thread metric

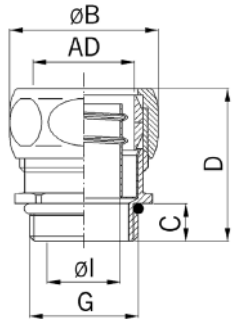



Material: Messing vernickelt  
 Hülsen: Messing vernickelt  
 Dichting: TPE  
 O-Ring: NBR  
 Eigenschaften: Hoher Staub- und Flüssigkeitsschutz, kraftschlüssige Verbindung von Schlauch und Verschraubung, Abdeckung der Schlauchenden, vibrations- und zugfest  
 Schutzart: IP 40  
 Einsatztemperatur: -40°C / +125°C

Material: Nickel-plated brass  
 Bushing: Nickel-plated brass  
 Sealing ring: TPE  
 O-ring: NBR  
 Properties: Highly watertight and dust-proof, friction locking of conduit and gland, covered conduit ends, resistant to stretch and vibrations  
 Protection class: IP 40  
 Temperature range: -40°C / +125°C



Schlauchverschraubung US-M  
 SPR-AS, SPR-VA / FLEXAgraff-AS

Conduit gland US-M  
 SPR-AS, SPR-VA / FLEXAgraff-AS

AD mm	i info	G	ØI mm	ØB mm	C mm	D mm	 mm	Art.-Nr.   Art. No.	
10	-	M10x1.0	6.5	19	10	31	15/17	5010.327.010	50
14	-	M12x1.5	9.0	23	10	33	19/21	5010.327.012	50
14	1	M12x1.5	9.0	23	10	33	19/21	5010.339.012	50
17	-	M16x1.5	12.5	27	10	33	23/25	5010.327.016	50
21	-	M20x1.5	16.0	31	10	33	27/29	5010.327.020	50
27	-	M25x1.5	21.0	39	11	41	34/36	5010.327.025	25
27	1	M25x1.5	21.0	39	11	41	34/36	5010.339.025	25
36	-	M32x1.5	27.5	48	13	43	43/45	5010.327.032	25
45	-	M40x1.5	35.0	57	13	43	52/54	5010.327.040	20
56	-	M50x1.5	45.0	70	14	49	63/66	5010.327.050	10
56	-	M63x1.5	45.0	75	14	49	70/70	5010.327.163	10

1 = Für FLEXAgraff-AS

1 = For FLEXAgraff-AS

Technischer Hinweis

Technical note

Die Funktionssicherheit ist nur gewährleistet bei Verwendung der passenden Stabilisierungshülse



The reliability is only guaranteed with the corresponding stabilizing bush

### Anschlussgewinde Pg | Entry thread Pg



Schlauchverschraubung US-P  
 SPR-AS, SPR-VA / FLEXAgraff-AS

Conduit gland US-P  
 SPR-AS, SPR-VA / FLEXAgraff-AS

AD mm	i info	G	ØI mm	ØB mm	C mm	D mm	 mm	Art.-Nr.   Art. No.	
10	-	Pg 7	6.5	19	7	28	15/17	5010.127.007	50
14	-	Pg 9	10.0	23	7	30	19/21	5010.127.009	50
14	1	Pg 9	10.5	23	7	30	19/21	5010.139.009	50
17	-	Pg 11	12.5	27	7	30	23/25	5010.127.011	50
19	-	Pg 13	14.5	29	7	30	25/27	5010.127.013	50
21	-	Pg 16	16.5	31	7	30	27/29	5010.127.016	50
27	-	Pg 21	21.5	39	10	40	34/36	5010.127.021	25
27	1	Pg 21	22.5	39	10	40	34/36	5010.139.021	25
36	-	Pg 29	29.0	48	10	40	43/45	5010.127.029	25
45	-	Pg 36	38.0	57	10	40	52/54	5010.127.036	20
56	-	Pg 48	49.0	70	10	45	63/66	5010.127.048	10

1 = Für FLEXAgraff-AS

1 = For FLEXAgraff-AS

Technischer Hinweis

Technical note

Die Funktionssicherheit ist nur gewährleistet bei Verwendung der passenden Stabilisierungshülse

The reliability is only guaranteed with the corresponding stabilizing bush

# Schlauchverschraubung Messing komplett

## Complete conduit gland nickel-plated brass

### Anschlussgewinde metrisch | Entry thread metric

Material: Messing vernickelt  
 Hülse: Messing blank  
 Dichtring: TPE  
 O-Ring: NBR

Eigenschaften: Hoher Staub- und Flüssigkeitsschutz, kraftschlüssige Verbindung von Schlauch und Verschraubung, Abdeckung der Schlauchenden, vibrations- und zugfest



Schutzart: IP 65  
 Einsatztemperatur: -40°C / +125°C

Material: Nickel-plated brass  
 Bushing: Polished brass  
 Sealing ring: TPE  
 O-ring: NBR

Properties: Highly watertight and dust-proof, friction locking of conduit and gland, covered conduit ends, resistant to stretch and vibrations

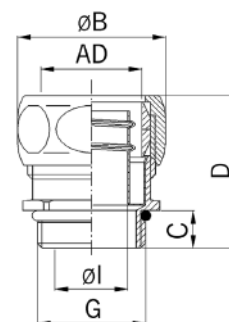
Protection class: IP 65  
 Temperature range: -40°C / +125°C



Schlauchverschraubung US-M SPR-PVC-AS, SPR-PU-AS / FLEXAgraff-PU-AS								Conduit gland US-M SPR-PVC-AS, SPR-PU-AS / FLEXAgraff-PU-AS		
AD mm	i info	G	ØI mm	ØB mm	C mm	D mm	 mm	Art.-Nr.   Art. No.		
10	-	M10x1.0	6.0	19	10	31	15/17	5010.328.010	50	
14	-	M12x1.5	8.5	23	10	33	19/21	5010.328.012	50	
14	1	M12x1.5	9.0	23	10	33	19/21	5010.327.012	50	
17	-	M16x1.5	11.5	27	10	33	23/25	5010.328.016	50	
21	-	M20x1.5	15.5	31	10	33	27/29	5010.328.020	50	
27	-	M25x1.5	20.5	39	11	41	34/36	5010.328.025	25	
27	1	M25x1.5	21.0	39	11	41	34/36	5010.340.025	25	
36	-	M32x1.5	27.5	48	13	43	43/45	5010.328.032	25	
45	-	M40x1.5	35.0	57	13	43	52/54	5010.328.040	20	
56	-	M50x1.5	45.0	70	14	49	63/66	5010.328.050	10	
56	-	M63x1.5	45.0	75	14	49	70/70	5010.328.163	10	

1 = Für FLEXAgraff-PU-AS      1 = For FLEXAgraff-PU-AS



Technischer Hinweis      Technical note

Die Funktionssicherheit ist nur gewährleistet bei Verwendung der passenden Stabilisierungshülse      The reliability is only guaranteed with the corresponding stabilizing bush



### Anschlussgewinde Pg | Entry thread Pg



Schlauchverschraubung US-P SPR-PVC-AS, SPR-PU-AS / FLEXAgraff-PU-AS								Conduit gland US-P SPR-PVC-AS, SPR-PU-AS / FLEXAgraff-PU-AS		
AD mm	i info	G	ØI mm	ØB mm	C mm	D mm	 mm	Art.-Nr.   Art. No.		
10	-	Pg 7	6.0	19	7	28	15/17	5010.128.007	50	
14	-	Pg 9	8.5	23	7	30	19/21	5010.128.009	50	
14	1	Pg 9	10.0	23	7	30	19/21	5010.127.009	50	
17	-	Pg 11	11.5	27	7	30	23/25	5010.128.011	50	
19	-	Pg 13	13.5	29	7	30	25/27	5010.128.013	50	
21	-	Pg 16	15.5	31	7	30	27/29	5010.128.016	50	
27	-	Pg 21	20.5	39	10	40	34/36	5010.128.021	25	
27	1	Pg 21	20.5	39	10	40	34/36	5010.140.021	25	
36	-	Pg 29	27.5	48	10	40	43/45	5010.128.029	25	
45	-	Pg 36	36.5	57	10	40	52/54	5010.128.036	20	
56	-	Pg 48	47.5	70	10	45	63/66	5010.128.048	10	

1 = Für FLEXAgraff-PU-AS      1 = For FLEXAgraff-PU-AS

Technischer Hinweis      Technical note

Die Funktionssicherheit ist nur gewährleistet bei Verwendung der passenden Stabilisierungshülse      The reliability is only guaranteed with the corresponding stabilizing bush



# Schlauchverschraubung Messing komplett

## Complete conduit gland nickel-plated brass

### Anschlussgewinde metrisch | Entry thread metric

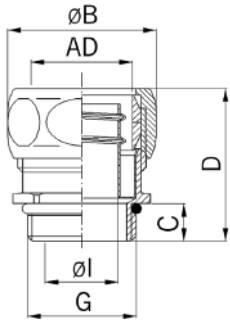

Material: Messing vernickelt  
 Hülse: Messing blank  
 Dichtring: TPE  
 O-Ring: NBR  
 Eigenschaften: Hoher Staub- und Flüssigkeitschutz, kraftschlüssige Verbindung von Schlauch und Verschraubung, Abdeckung der Schlauchenden, vibrations- und zugfest  
 Schutzart: IP 66  
 Einsatztemperatur: -40°C / +125°C

Material: Nickel-plated brass  
 Bushing: Polished brass  
 Sealing ring: TPE  
 O-ring: NBR  
 Properties: Highly watertight and dust-proof, friction locking of conduit and gland, covered conduit ends, resistant to stretch and vibrations  
 Protection class: IP 66  
 Temperature range: -40°C / +125°C



Schlauchverschraubung US-M  
 FLEXAgraff®-SI-ASF

Conduit gland US-M  
 FLEXAgraff®-SI-ASF

AD mm	G	ØI mm	ØB mm	C mm	D mm	mm	Art.-Nr.   Art. No.	
14	M12x1.5	9.0	23	10	33	19/21	5010.337.012	50
17	M16x1.5	10.5	27	10	33	23/25	5010.337.016	50
21	M20x1.5	14.5	31	10	33	27/29	5010.335.020	50
27	M25x1.5	19.5	39	11	41	34/36	5010.301.025	25
36	M32x1.5	26.5	48	13	43	43/45	5010.337.032	25
45	M40x1.5	34.5	57	13	43	52/54	5010.337.040	20
56	M50x1.5	45.0	70	14	49	63/66	5010.337.050	10
56	M63x1.5	45.0	75	14	49	70/70	5010.337.163	10

Technischer Hinweis

Die Funktionssicherheit ist nur gewährleistet bei Verwendung der passenden Stabilisierungshülse

Technical note

The reliability is only guaranteed with the corresponding stabilizing bush

### Anschlussgewinde Pg | Entry thread Pg



Schlauchverschraubung US-P  
 FLEXAgraff®-SI-ASF

Conduit gland US-P  
 FLEXAgraff®-SI-ASF

AD mm	G	ØI mm	ØB mm	C mm	D mm	mm	Art.-Nr.   Art. No.	
14	Pg 9	9.0	23	7	30	19/21	5010.137.009	50
17	Pg 11	11.5	27	7	30	23/25	5010.137.011	50
19	Pg 13	12.5	29	7	30	25/27	5010.137.013	50
21	Pg 16	14.5	31	7	30	27/29	5010.135.016	50
27	Pg 21	19.5	39	10	40	34/36	5010.601.021	25
36	Pg 29	26.5	48	10	40	43/45	5010.137.029	25
45	Pg 36	34.5	57	10	40	52/54	5010.137.036	20
56	Pg 48	45.5	70	10	45	63/66	5010.137.048	10

Technischer Hinweis

Die Funktionssicherheit ist nur gewährleistet bei Verwendung der passenden Stabilisierungshülse

Technical note

The reliability is only guaranteed with the corresponding stabilizing bush

# Schlauchverschraubung Messing komplett

## Complete conduit gland nickel-plated brass

### Anschlussgewinde metrisch | Entry thread metric

Material: Messing vernickelt  
 Hülse: Polypropylen  
 Dichtring: TPE  
 O-Ring: NBR

Eigenschaften: Hoher Staub- und Flüssigkeitsschutz, kraftschlüssige Verbindung von Schlauch und Verschraubung, Abdeckung der Schlauchenden, vibrations- und zugfest

Schutzart: IP 54  
 Einsatztemperatur: -40°C / +125°C

Material: Nickel-plated brass  
 Bushing: Polypropylene  
 Sealing ring: TPE  
 O-ring: NBR

Properties: Highly watertight and dust-proof, friction locking of conduit and gland, covered conduit ends, resistant to stretch and vibrations

Protection class: IP 54  
 Temperature range: -40°C / +125°C

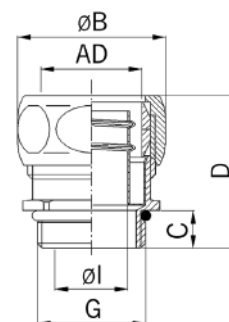

Schlauchverschraubung US-M AIRflex-KUW-PU-AS / -KUW-PVC-AS / -GRS							Conduit gland US-M AIRflex-KUW-PU-AS / -KUW-PVC-AS / -GRS	
AD mm	G	ØI mm	ØB mm	C mm	D mm		Art.-Nr.   Art. No.	
10	M10x1.0	6.0	19	10	31	15/17	5010.330.010	50
14	M12x1.5	9.0	23	10	33	19/21	5010.330.012	50
17	M16x1.5	11.5	27	10	33	23/25	5010.330.016	50
21	M20x1.5	14.5	27	10	33	23/25	5010.330.020	50
27	M25x1.5	19.5	39	11	41	34/36	5010.330.025	25
36	M32x1.5	26.5	48	13	43	43/45	5010.330.032	25
45	M40x1.5	35.0	57	13	43	52/54	5010.330.040	20
56	M50x1.5	45.0	70	14	49	63/66	5010.330.050	10

#### Technischer Hinweis

Die Funktionssicherheit ist nur gewährleistet bei Verwendung der passenden Stabilisierungshülse

#### Technical note

The reliability is only guaranteed with the corresponding stabilizing bush



### Anschlussgewinde Pg | Entry thread Pg



Schlauchverschraubung US-P AIRflex-KUW-PU-AS / -KUW-PVC-AS / -GRS							Conduit gland US-P AIRflex-KUW-PU-AS / -KUW-PVC-AS / -GRS	
AD mm	G	ØI mm	ØB mm	C mm	D mm		Art.-Nr.   Art. No.	
10	Pg 7	6.0	19	7	28	15/17	5010.130.007	50
14	Pg 9	9.0	23	7	30	19/21	5010.130.009	50
17	Pg 11	11.5	27	7	30	23/25	5010.130.011	50
19	Pg 13	13.0	29	7	30	25/27	5010.130.013	50
21	Pg 16	14.5	31	7	30	27/29	5010.130.016	50
27	Pg 21	19.5	39	10	40	34/36	5010.130.021	25
36	Pg 29	26.5	48	10	40	43/45	5010.130.029	25
45	Pg 36	36.0	57	10	40	52/54	5010.130.036	20
56	Pg 48	45.5	70	10	45	63/66	5010.130.048	10

#### Technischer Hinweis

Die Funktionssicherheit ist nur gewährleistet bei Verwendung der passenden Stabilisierungshülse

#### Technical note

The reliability is only guaranteed with the corresponding stabilizing bush





# EMV-Schlauchverschraubung Messing komplett

## Complete EMC conduit gland nickel-plated brass

### Anschlussgewinde metrisch | Entry thread metric

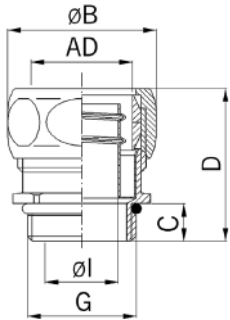

Material: Messing vernickelt  
 Hülse: Messing blank  
 Druckring: Messing blank  
 O-Ring: NBR  
 Eigenschaften: Hoher Staub- und Flüssigkeitsschutz, kraftschlüssige Verbindung von Schlauch und Verschraubung, einwandfreie Erdung, Abdeckung der Schlauchenden, vibrations- und zugfest

Schutzart: IP 40  
 Einsatztemperatur: -40°C / +250°C

Material: Nickel-plated brass  
 Bushing: Polished brass  
 Thrust collar: Polished brass  
 O-ring: NBR  
 Properties: Highly watertight and dust-proof, friction locking of conduit and gland, proper earthing, covered conduit ends, resistant to stretch and vibrations

Protection class: IP 40  
 Temperature range: -40°C / +250°C



Schlauchverschraubung US-M  
 zu FLEXAgraff-CU-AS / SPR-EDU-AS  
 Mit Messing-Druckring

Conduit gland US-M  
 for FLEXAgraff-CU-AS / SPR-EDU-AS  
 with brass thrust collar

AD mm	i info	G	Øl mm	ØB mm	C mm	D mm		Art.-Nr.   Art. No.	
10	-	M10x1.0	6.0	19	10	31	15/17	5011.328.010	50
14	-	M12x1.5	9.0	23	10	33	19/21	5011.327.012	50
14	1	M12x1.5	8.5	23	10	33	19/21	5011.328.012	50
17	-	M16x1.5	11.5	27	10	33	23/25	5011.328.016	50
21	-	M20x1.5	16.0	31	10	33	27/29	5011.328.020	50
27	-	M25x1.5	21.0	39	11	41	34/36	5011.340.025	25
27	1	M25x1.5	20.5	39	11	41	34/36	5011.328.025	25
36	-	M32x1.5	27.5	48	13	43	43/45	5011.328.032	25
45	-	M40x1.5	35.0	57	13	43	52/54	5011.328.040	20
56	-	M50x1.5	45.0	70	14	49	63/66	5011.328.050	10

1 = Für SPR-EDU-AS

1 = For SPR-EDU-AS

Technischer Hinweis

Technical note

Die Funktionssicherheit ist nur gewährleistet bei Verwendung der passenden Stabilisierungshülse

The reliability is only guaranteed with the corresponding stabilizing bush

### Anschlussgewinde Pg | Entry thread Pg



Schlauchverschraubung US-P  
 zu FLEXAgraff-CU-AS / SPR-EDU-AS  
 Mit Messing-Druckring

Conduit gland US-P  
 for FLEXAgraff-CU-AS / SPR-EDU-AS  
 with brass thrust collar

AD mm	i info	G	Øl mm	ØB mm	C mm	D mm		Art.-Nr.   Art. No.	
10	-	Pg 7	6.0	19	7	28	15/17	5011.128.007	50
14	-	Pg 9	9.0	23	7	30	19/21	5011.127.009	50
14	1	Pg 9	8.5	23	7	30	19/21	5011.128.009	10
17	-	Pg 11	11.5	27	7	30	23/25	5011.128.011	50
19	-	Pg 13	13.5	29	7	30	25/27	5011.128.013	50
21	-	Pg 16	15.5	31	7	30	27/29	5011.128.016	50
27	-	Pg 21	21.5	39	10	40	34/36	5011.140.021	25
27	1	Pg 21	20.5	39	10	40	34/36	5011.128.021	25
36	-	Pg 29	27.5	48	10	40	43/45	5011.128.029	25
45	-	Pg 36	36.5	57	10	40	52/54	5011.128.036	20
56	-	Pg 48	47.5	70	10	45	63/66	5011.128.048	10

1 = Für SPR-EDU-AS

1 = For SPR-EDU-AS

Technischer Hinweis

Technical note

Die Funktionssicherheit ist nur gewährleistet bei Verwendung der passenden Stabilisierungshülse

The reliability is only guaranteed with the corresponding stabilizing bush

# EMV-Schlauchverschraubung Messing komplett

## Complete EMC conduit connectors nickel-plated brass

Anschlussgewinde metrisch | Entry thread metric

Material: Messing vernickelt  
 Hülse: Messing blank  
 Druckring: Messing blank  
 Dichtring: TPE  
 O-Ring: NBR

Material: Nickel-plated brass  
 Bushing: Polished brass  
 Thrust collar: Polished brass  
 Sealing ring: TPE  
 O-ring: NBR  
 Properties: Highly watertight and dust-proof, friction locking of conduit and gland, proper earthing, covered conduit ends, resistant to stretch and vibrations

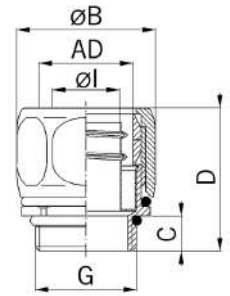

Schutzart: IP 67  
 Einsatztemperatur: -40°C / +125°C

Protection class: IP 67  
 Temperature range: -40°C / +125°C



Schlauchverschraubung USD-M  
 zu FLEXAgraff-CU-PU-AS  
 Mit Messing-Druckring

Conduit gland USD-M  
 for FLEXAgraff-CU-PU-AS  
 with brass thrust collar

AD mm	G	ØI mm	ØB mm	C mm	D mm		Art.-Nr.   Art. No.	
14	M12x1.5	9.0	23	7	30	19/21	5015.327.012	50
17	M16x1.5	11.5	27	7	30	23/25	5015.328.016	50
21	M20x1.5	15.5	31	7	30	27/29	5015.328.020	50
27	M25x1.5	20.5	39	10	41	34/36	5015.340.025	10
36	M32x1.5	27.5	48	10	44	43/45	5015.328.032	25
45	M40x1.5	35.0	57	10	44	52/54	5015.328.040	20
56	M50x1.5	45.0	70	10	48	63/66	5015.328.050	10



Technischer Hinweis

Die Funktionssicherheit ist nur gewährleistet bei Verwendung der passenden Stabilisierungshülse

Technical note

The reliability is only guaranteed with the corresponding stabilizing bush

# EMV-Schlauchverschraubung Messing komplett

## Complete EMC conduit connectors nickel-plated brass

### Anschlussgewinde metrisch | Entry thread metric

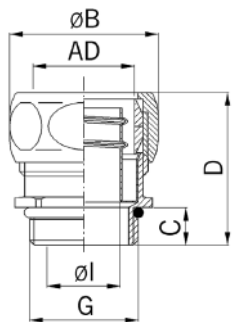

Material: Messing vernickelt  
 Hülse: Messing blank  
 Druckring: Messing blank  
 O-Ring: NBR  
 Eigenschaften: Hoher Staub- und Flüssigkeitsschutz, kraftschlüssige Verbindung von Schlauch und Verschraubung, Abdeckung der Schlauchenden, vibrations- und zugfest  
 Schutzart: IP 54  
 Einsatztemperatur: -40°C / +125°C

Material: Nickel-plated brass  
 Bushing: Polished brass  
 Thrust collar: Polished brass  
 O-ring: NBR  
 Properties: Highly watertight and dust-proof, friction locking of conduit and gland, covered conduit ends, resistant to stretch and vibrations  
 Protection class: IP 54  
 Temperature range: -40°C / +125°C



Schlauchverschraubung US-M  
 AIRflex-KUW-EDU  
 Mit Messing-Druckring

Conduit gland US-M  
 AIRflex-KUW-EDU  
 with brass thrust collar

AD mm	G	ØI mm	ØB mm	C mm	D mm		Art.-Nr.   Art. No.	
14	M12x1.5	8.5	23	10	33	19/21	5011.328.012	50
17	M16x1.5	11.0	27	10	33	23/25	5011.335.016	50
21	M20x1.5	14.5	31	10	33	27/29	5011.335.020	50
27	M25x1.5	19.5	39	11	41	34/36	5011.335.025	25
36	M32x1.5	27.5	48	13	43	43/45	5011.328.032	25
45	M40x1.5	35.0	57	13	43	52/54	5011.335.040	20
56	M50x1.5	45.0	70	14	49	63/66	5011.335.050	10
56	M63x1.5	45.0	75	14	49	70/70	5011.335.163	10

Technischer Hinweis

Die Funktionssicherheit ist nur gewährleistet bei Verwendung der passenden Stabilisierungshülse

Technical note

The reliability is only guaranteed with the corresponding stabilizing bush



### Anschlussgewinde Pg | Entry thread Pg



Schlauchverschraubung US-P  
 AIRflex-KUW-EDU  
 Mit Messing-Druckring

Conduit gland US-P  
 AIRflex-KUW-EDU  
 with brass thrust collar

AD mm	G	ØI mm	ØB mm	C mm	D mm		Art.-Nr.   Art. No.	
14	Pg 9	8.5	23	7	30	19/21	5011.128.009	50
17	Pg 11	11.0	27	7	30	23/25	5011.135.011	50
19	Pg 13	13.0	29	7	30	25/27	5011.135.013	50
21	Pg 16	14.5	31	7	30	27/29	5011.135.016	50
27	Pg 21	19.5	39	10	40	34/36	5011.135.021	25
36	Pg 29	27.5	48	10	40	43/45	5011.128.029	25
45	Pg 36	35.5	57	10	40	52/54	5011.135.036	20
56	Pg 48	47.0	70	10	45	63/66	5011.135.048	10

Technischer Hinweis

Die Funktionssicherheit ist nur gewährleistet bei Verwendung der passenden Stabilisierungshülse

Technical note

The reliability is only guaranteed with the corresponding stabilizing bush



# Schlauchverschraubung Messing mit Innengewinde

## Complete conduit gland nickel-plated brass with internal thread

Innengewinde metrisch | Internal entry thread metric

Material: Messing vernickelt  
Dichtung: TPE

Eigenschaften: Hoher Staub- und Flüssigkeitsschutz, kraftschlüssige Verbindung von Schlauch und Verschraubung, Abdeckung der Schlauchenden, vibrations- und zugfest



Schutzart: IP 40  
Einsatztemperatur: -40°C / +125°C

Material: Nickel-plated brass  
Seal: TPE

Properties: Highly watertight and dust-proof, friction locking of conduit and gland, covered conduit ends, resistant to stretch and vibrations

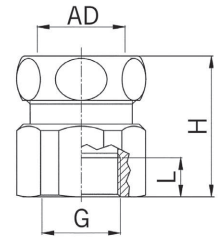
Protection class: IP 40  
Temperature range: -40°C / +125°C



Schlauchverschraubung Anschluss mit Innengewinde metrisch					Conduit gland Internal thread metric	
AD mm	G	H mm	L mm		Art.-Nr.   Art. No.	
10	M10x1.5	26	8	15/16	2600.10.10	50
14	M12x1.5	27	8	21/21	2600.12.14	50
17	M16x1.5	27	8	24/25	2600.17.17	50
19	M20x1.5	30	10	27/27	2600.20.19	25
21	M20x1.5	30	10	30/29	2600.20.21	25
27	M25x1.5	37	11	36/36	2600.25.27	25
36	M32x1.5	39	11	46/45	2600.32.36	25
45	M40x1.5	42	12	55/54	2600.40.45	10
56	M50x1.5	46	12	65/66	2600.50.56	10

Technischer Hinweis

Je nach Schlauchtyp muss die passende Stabilisierungshülse separat bestellt werden.

Technical note

Depending on the type of conduit, the stabilising bush must be ordered separately.



1  
2  
3  
4  
5  
6  
7  
8  
9  
10  
11  
12

# Schlauchverschraubung drehbar Messing

## Swivelling conduit gland nickel-plated brass

### Langes Anschlussgewinde metrisch | Long entry thread metric

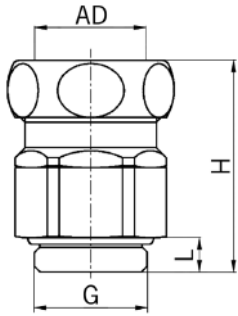

Material: Messing vernickelt  
 Dichtung: TPE  
 O-Ring: Separat bestellen  
 Schutzart: IP 40 - IP 66, abhängig von der Kombination Schlauch und Verschraubung  
 Einsatztemperatur: -40°C / +125°C

Material: Nickel-plated brass  
 Seal: TPE  
 O-ring: To be ordered separately  
 Protection class: IP 40 - IP 66, in dependence of the combination of conduit and connector  
 Temperature range: -40°C / +125°C



Schlauchverschraubung drehbar Messing

Swivelling conduit connectors nickel-plated brass

G	AD mm	mm	H mm	L mm	Art.-Nr.   Art. No.	
M12x1.5	10	15/17	28	10	2100.12.10.02	50
M16x1.5	14	21/21	30	10	2100.17.14.02	50
M20x1.5	17	24/25	30	10	2100.20.17.02	50
M20x1.5	19	24/27	30	10	2100.20.19.02	50
M25x1.5	21	30/29	31	11	2100.25.21.02	25
M32x1.5	27	36/36	38	13	2100.32.27.02	25
M40x1.5	36	46/45	42	13	2100.40.36.02	25
M50x1.5	45	55/54	50	14	2100.50.45.02	10
M63x1.5	56	70/66	54	14	2100.63.56.02	10

Technischer Hinweis

Technical note

Je nach Schlauchtyp muss die passende Stabilisierungshülse separat bestellt werden.

Depending on the type of conduit, the stabilising bush must be ordered separately.

### Langes Anschlussgewinde Pg | Long entry thread Pg



Schlauchverschraubung drehbar Messing

Swivelling conduit connectors nickel-plated brass

G	AD mm	mm	H mm	L mm	Art.-Nr.   Art. No.	
Pg 7	10	15/17	28	10	2100.07.10.02	50
Pg 9	14	21/21	30	10	2100.09.14.02	50
Pg 11	17	24/25	30	10	2100.11.17.02	50
Pg 13	19	24/27	31	10	2100.13.19.02	50
Pg 16	21	30/29	31	10	2100.16.21.02	25
Pg 21	27	36/36	38	12	2100.21.27.02	25
Pg 29	36	46/45	42	12	2100.29.36.02	25
Pg 36	45	55/54	50	15	2100.36.45.02	10
Pg 48	56	70/66	54	15	2100.48.56.02	10

Technischer Hinweis

Technical note

Je nach Schlauchtyp muss die passende Stabilisierungshülse separat bestellt werden.

Depending on the type of conduit, the stabilising bush must be ordered separately.



# AGRO Kombi-Schlauchverschraubung Progress® Messing mit integrierter Kabelverschraubung AGRO combination conduit gland Progress® nickel-plated brass with integrated cable gland

## Kurzes Anschlussgewinde metrisch | Short entry thread metric

Material:	Messing vernickelt	Material:	Nickel-plated brass
Dichtung:	TPE	Seal:	TPE
O-Ring:	NBR	O-ring:	NBR
Zugentlastung:	Ausführung A nach EN 62444	Strain relief:	Version A acc. to EN 62444
Schutzart:	Kabelverschraubung IP 68	Protection class:	Cable gland IP 68
Einsatztemperatur:	-40°C / +100°C	Temperature range:	-40°C / +100°C
Hinweis:	Der max. Klemmbereich ist abhängig vom Schlauch-Innendurchmesser	Note:	The max. clamping range depends on the conduit inner diameter

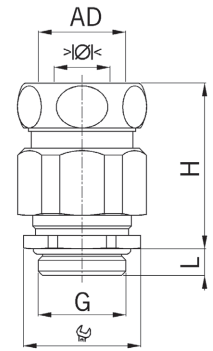

### Progress MS Kombi



Für Schlauchanschluss AD mm Zweiteiliger Dichteinsatz nicht durchgehend isolierend		Connector for tubing with AD mm Two-piece sealing insert not overall length insulated					Art.-Nr.   Art. No.	
G	AD mm	>Ø< min mm	>Ø< max mm	Ø mm	H mm	L mm		
M12x1.5	10	5.0	6.5	15/17	33	5	1700.12.10	50
M16x1.5	14	6.0	10.5	18/21	38	5	1700.17.14	50
M20x1.5	17	8.0	15.0	24/25	38	6	1700.20.17	25
M20x1.5	19	8.0	15.0	24/27	39	6	1700.20.19	25
M20x1.5	21	8.0	15.0	24/29	39	6	1700.20.21	25
M25x1.5	21	12.5	20.5	30/29	43	7	1700.25.21	25
M25x1.5	27	12.5	20.5	30/36	50	7	1700.25.27	25
M32x1.5	27	17.0	25.5	36/36	52	8	1700.32.27	25
M40x1.5	36	24.0	33.0	46/45	56	8	1700.40.36	10
M50x1.5	45	33.0	42.0	55/54	60	9	1700.50.45	10
M63x1.5	56	40.0	52.0	70/66	67	10	1700.63.56	5

Je nach Schlauchtyp muss die passende Stabilisierungshülse separat bestellt werden.  
Erhältlich mit Dichteinsatz gemäss EN 45545. Bei Anfragen oder Bestellung bitte ein F vor die Artikelnummer setzen.

Depending on the type of conduit, the stabilising bush must be ordered separately.  
Available with sealing inserts conformity with EN 45545. When placing an inquiry, prefix the article number by the capital F.



## Langes Anschlussgewinde metrisch | Long entry thread metric

### Progress MS Kombi



Für Schlauchanschluss AD mm Zweiteiliger Dichteinsatz durchgehend isolierend		Connector for tubing with AD mm Two-piece sealing insert overall length insulated					Art.-Nr.   Art. No.	
G	AD mm	>Ø< min mm	>Ø< max mm	Ø mm	H mm	L mm		
M12x1.5	10	5.0	6.5	15/17	33	10	1710.60.12.10	50
M16x1.5	14	6.0	10.5	18/21	38	10	1710.60.17.14	50
M20x1.5	17	8.0	14.5	24/25	38	10	1710.60.20.17	25
M20x1.5	19	8.0	14.5	24/27	39	10	1710.60.20.19	25
M20x1.5	21	8.0	14.5	24/29	39	10	1710.60.20.21	25
M25x1.5	21	12.5	19.0	30/29	43	11	1710.60.25.21	25
M25x1.5	27	12.5	19.0	30/36	50	11	1710.60.25.27	25
M32x1.5	27	17.0	25.5	36/36	52	13	1710.60.32.27	25
M40x1.5	36	24.0	33.0	46/45	56	13	1710.60.40.36	10
M50x1.5	45	33.0	42.0	55/54	60	14	1710.60.50.45	10
M63x1.5	56	40.0	52.0	70/66	67	14	1710.60.63.56	5

Je nach Schlauchtyp muss die passende Stabilisierungshülse separat bestellt werden.  
Erhältlich mit Dichteinsatz gemäss EN 45545. Bei Anfragen oder Bestellung bitte ein F vor die Artikelnummer setzen.

Depending on the type of conduit, the stabilising bush must be ordered separately.  
Available with sealing inserts conformity with EN 45545. When placing an inquiry, prefix the article number by the capital F.



# AGRO Kombi-Schlauchverschraubung Progress® Messing mit integrierter Kabelverschraubung

## AGRO combination conduit gland Progress® nickel-plated brass with integrated cable gland

### Kurzes Anschlussgewinde metrisch | Short entry thread metric

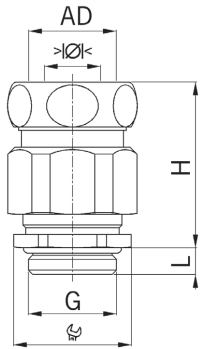

Material: Messing vernickelt  
 Dichtung: TPE  
 O-Ring: NBR  
 Zugentlastung: Ausführung A nach EN 62444  
 Schutzart: Kabelverschraubung IP 68  
 Einsatztemperatur: -40°C / +100°C  
 Hinweis: Der max. Klemmbereich ist abhängig vom Schlauch-Innen-durchmesser

Material: Nickel-plated brass  
 Seal: TPE  
 O-ring: NBR  
 Strain relief: Version A acc. to EN 62444  
 Protection class: Cable gland IP 68  
 Temperature range: -40°C / +100°C  
 Note: The max. clamping range depends on the conduit inner diameter



#### Progress MS Kombi

Für Schlauchanschluss AD Zoll  
 Zweiteiliger Dichteinsatz  
 nicht durchgehend isolierend

Connector for tubing with AD in inches  
 Two-piece sealing insert  
 not overall length insulated



G	AD mm	> Ø < min mm	> Ø < max mm	mm	H mm	L mm	Art.-Nr.   Art. No.	
M20x1.5	3/8"	8.0	15.0	24/27	42	6	1700.20.3/8	25
M20x1.5	1/2"	8.0	15.0	24/29	38	6	1700.20.1/2	25
M25x1.5	3/4"	12.5	20.5	30/36	52	7	1700.25.3/4	25
M32x1.5	1"	17.0	25.5	36/45	55	8	1700.32.1	25

Je nach Schlauchtyp muss die passende Stabilisierungshülse separat bestellt werden.

Depending on the type of conduit, the stabilising bush must be ordered separately.

Erhältlich mit Dichteinsatz gemäss EN 45545. Bei Anfragen oder Bestellung bitte ein F vor die Artikelnummer setzen.

Available with sealing inserts conformity with EN 45545. When placing an inquiry, prefix the article number by the capital F.

### Langes Anschlussgewinde metrisch | Long entry thread metric



#### Progress MS Kombi

Für Schlauchanschluss AD Zoll  
 Zweiteiliger Dichteinsatz  
 durchgehend isolierend

Connector for tubing with AD in inches  
 Two-piece sealing insert  
 overall length insulated



G	AD mm	> Ø < min mm	> Ø < max mm	mm	H mm	L mm	Art.-Nr.   Art. No.	
M20x1.5	3/8"	8.0	14.5	24/27	42	10	1710.60.20.3/8	25
M20x1.5	1/2"	8.0	14.5	24/29	38	10	1710.60.20.1/2	25
M25x1.5	3/4"	12.5	19.0	30/36	52	11	1710.60.25.3/4	25
M32x1.5	1"	17.0	19.0	36/45	55	13	1710.60.32.1	25

Je nach Schlauchtyp muss die passende Stabilisierungshülse separat bestellt werden.

Depending on the type of conduit, the stabilising bush must be ordered separately.

Erhältlich mit Dichteinsatz gemäss EN 45545. Bei Anfragen oder Bestellung bitte ein F vor die Artikelnummer setzen.

Available with sealing inserts conformity with EN 45545. When placing an inquiry, prefix the article number by the capital F.

# AGRO Kombi-Schlauchverschraubung Progress® Messing mit integrierter Kabelverschraubung

## AGRO combination conduit gland Progress® nickel-plated brass with integrated cable gland

### Kurzes Anschlussgewinde Pg | Short entry thread Pg

Material: Messing vernickelt  
 Dichtung: TPE  
 O-Ring: NBR  
 Zugentlastung: Ausführung A nach EN 62444  
 Schutzart: Kabelverschraubung IP 68  
 Einsatztemperatur: -40°C / +100°C  
 Hinweis: Der max. Klemmbereich ist abhängig vom Schlauch-Innen-durchmesser

Material: Nickel-plated brass  
 Seal: TPE  
 O-ring: NBR  
 Strain relief: Version A acc. to EN 62444  
 Protection class: Cable gland IP 68  
 Temperature range: -40°C / +100°C  
 Note: The max. clamping range depends on the conduit inner diameter

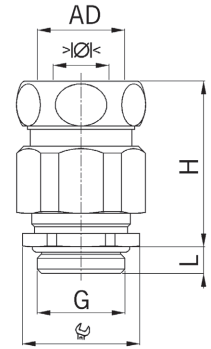

#### Progress MS Kombi



Für Schlauchanschluss AD mm  
 Zweiteiliger Dichteinsatz  
 nicht durchgehend isolierend

Connector for tubing with AD mm  
 Two-piece sealing insert  
 not overall length insulated

G	AD mm	>Ø< min mm	>Ø< max mm	Ø mm	H mm	L mm	Art.-Nr.   Art. No.	
Pg 7	10	5.0	6.5	15/17	33	6	1700.07.10	50
Pg 9	14	6.0	10.5	18/21	38	6	1700.09.14	50
Pg 11	14	5.5	12.0	21/21	39	6	1700.11.14	50
Pg 11	17	5.5	12.0	21/25	39	6	1700.11.17	50
Pg 13	19	8.0	15.0	24/27	39	6	1700.13.19	25
Pg 16	17	8.0	15.0	24/25	38	6	1700.16.17	25
Pg 16	21	8.0	15.0	24/29	39	6	1700.16.21	25
Pg 21	27	12.5	20.5	30/36	50	7.5	1700.21.27	25
Pg 29	36	19.0	27.5	38/45	55	8	1700.29.36	25
Pg 36	45	26.0	35.0	50/54	60	8	1700.36.45	10
Pg 42	45	33.0	42.0	55/54	60	10	1700.42.45	10
Pg 48	56	37.0	49.0	65/66	67	11	1700.48.56	10



Je nach Schlauchtyp muss die passende Stabilisierungshülse separat bestellt werden.

Depending on the type of conduit, the stabilising bush must be ordered separately.

Erhältlich mit Dichteinsatz gemäss EN 45545. Bei Anfragen oder Bestellung bitte ein F vor die Artikelnummer setzen.

Available with sealing inserts conformity with EN 45545. When placing an inquiry, prefix the article number by the capital F.

### Langes Anschlussgewinde Pg | Long entry thread Pg

#### Progress MS Kombi



Für Schlauchanschluss AD mm  
 Zweiteiliger Dichteinsatz  
 durchgehend isolierend

Connector for tubing with AD mm  
 Two-piece sealing insert  
 overall length insulated

G	AD mm	>Ø< min mm	>Ø< max mm	Ø mm	H mm	L mm	Art.-Nr.   Art. No.	
Pg 7	10	5.0	6.5	15/17	33	10	1710.60.07.10	50
Pg 9	14	6.0	10.5	18/21	38	10	1710.60.09.14	50
Pg 11	14	5.5	12.0	21/21	39	10	1710.60.11.14	50
Pg 11	17	5.5	12.0	21/25	39	10	1710.60.11.17	50
Pg 13	19	8.0	14.5	24/27	39	10	1710.60.13.19	25
Pg 16	17	8.0	14.5	24/25	38	10	1710.60.16.17	25
Pg 16	21	8.0	14.5	24/29	39	10	1710.60.16.21	25
Pg 21	27	12.5	19.0	30/36	50	12	1710.60.21.27	25
Pg 29	36	19.0	27.5	38/45	55	12	1710.60.29.36	25
Pg 36	45	26.0	35.0	50/54	60	15	1710.60.36.45	10
Pg 42	45	33.0	42.0	55/54	60	15	1710.60.42.45	10
Pg 48	56	37.0	49.0	65/66	67	15	1710.60.48.56	10



Je nach Schlauchtyp muss die passende Stabilisierungshülse separat bestellt werden.

Depending on the type of conduit, the stabilising bush must be ordered separately.

Erhältlich mit Dichteinsatz gemäss EN 45545. Bei Anfragen oder Bestellung bitte ein F vor die Artikelnummer setzen.

Available with sealing inserts conformity with EN 45545. When placing an inquiry, prefix the article number by the capital F.

# AGRO Adapter Progress® Messing mit integrierter Kabelverschraubung

## AGRO adapter Progress® nickel-plated brass with integrated cable gland

Langes Anschlussgewinde metrisch | Long entry thread metric

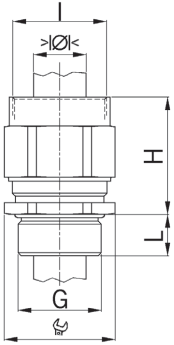

Material:	Messing vernickelt	Material:	Nickel-plated brass
Dichtung:	TPE	Seal:	TPE
O-Ring:	NBR	O-ring:	NBR
Zugentlastung:	Ausführung A nach EN 62444	Strain relief:	Version A acc. to EN 62444
Schutzart:	Kabelverschraubung IP 68	Protection class:	Cable gland IP 68
Einsatztemperatur:	-40°C / +100°C	Temperature range:	-40°C / +100°C
Hinweis:	Der max. Klemmbereich ist abhängig vom Schlauch-Innendurchmesser	Note:	The max. clamping range depends on the conduit inner diameter

### Progress MS Adapter



Einteiliger Dichteinsatz durchgehend isolierend

One-piece sealing insert overall length insulated

G	I	>Ø< min mm	>Ø< max mm	mm	H mm	L mm	i info	Art.-Nr.   Art. No.	
<b>M10x1.5</b>	M10x1.5	4.0	6.0	13	30	10	1	<b>1165.10</b>	50
<b>M12x1.5</b>	M12x1.5	5.0	6.5	15	32	10	-	<b>1165.12</b>	50

1 = Metrisches Regelgewinde (mit VDE Testreport)

1 = Metric coarse-pitch thread (with VDE test report)

Erhältlich mit Dichteinsatz gemäss EN 45545. Bei Anfragen oder Bestellung bitte ein F vor die Artikelnummer setzen.

Available with sealing inserts conformity with EN 45545. When placing an inquiry, prefix the article number by the capital F.

### Progress MS Adapter



Zweiteiliger Dichteinsatz durchgehend isolierend

Two-piece sealing insert overall length insulated

G	I	>Ø< min mm	>Ø< max mm	mm	H mm	L mm	Art.-Nr.   Art. No.	
<b>M16x1.5</b>	M16x1.5	6.0	10.5	18	35	10	<b>1165.17</b>	50
<b>M20x1.5</b>	M20x1.5	8.0	14.5	24	36	10	<b>1165.20</b>	25
<b>M25x1.5</b>	M25x1.5	12.5	19.0	30	41	11	<b>1165.25</b>	25
<b>M32x1.5</b>	M32x1.5	17.0	25.5	36	46	13	<b>1165.32</b>	25
<b>M40x1.5</b>	M40x1.5	24.0	33.0	46	48	13	<b>1165.40</b>	10
<b>M50x1.5</b>	M50x1.5	33.0	42.0	55	53	14	<b>1165.50</b>	5
<b>M63x1.5</b>	M63x1.5	40.0	52.0	70	56	14	<b>1165.63</b>	5

Erhältlich mit Dichteinsatz gemäss EN 45545. Bei Anfragen oder Bestellung bitte ein F vor die Artikelnummer setzen.

Available with sealing inserts conformity with EN 45545. When placing an inquiry, prefix the article number by the capital F.

# AGRO Adapter Progress® Messing mit integrierter Kabelverschraubung

## AGRO adapter Progress® nickel-plated brass with integrated cable gland

Langes Anschlussgewinde Pg | Long entry thread Pg

Material: Messing vernickelt  
 Dichtung: TPE  
 O-Ring: NBR  
 Schutzart: Kabelverschraubung IP 68  
 Einsatztemperatur: -40°C / +100°C  
 Hinweis: Der max. Klemmbereich ist abhängig vom Schlauch-Innen-durchmesser

Material: Nickel-plated brass  
 Seal: TPE  
 O-ring: NBR  
 Protection class: Cable gland IP 68  
 Temperature range: -40°C / +100°C  
 Note: The max. clamping range depends on the conduit inner diameter

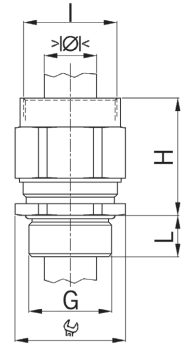

### Progress MS Adapter



Einteiliger Dichteinsatz  
 durchgehend isolierend

One-piece sealing insert  
 overall length insulated

G	I	>Ø< min mm	>Ø< max mm	 mm	H mm	L mm	Art.-Nr.   Art. No.	
<b>Pg 7</b>	Pg 7	5.0	6.5	15	30	10	<b>1165.07</b>	50

Erhältlich mit Dichteinsatz gemäss EN 45545. Bei Anfragen oder Bestellung bitte ein F vor die Artikelnummer setzen.

Available with sealing inserts conformity with EN 45545. When placing an inquiry, prefix the article number by the capital F.



### Progress MS Adapter



Zweiteiliger Dichteinsatz  
 durchgehend isolierend

Two-piece sealing insert  
 overall length insulated

G	I	>Ø< min mm	>Ø< max mm	 mm	H mm	L mm	Art.-Nr.   Art. No.	
<b>Pg 9</b>	Pg 9	6.0	10.5	18	35	10	<b>1165.09</b>	50
<b>Pg 11</b>	Pg 11	5.5	12.0	21	36	10	<b>1165.11</b>	50
<b>Pg 13</b>	Pg 13	8.0	14.5	24	36	10	<b>1165.13</b>	25
<b>Pg 16</b>	Pg 16	8.0	14.5	24	37	10	<b>1165.16</b>	25
<b>Pg 21</b>	Pg 21	12.5	19.0	30	42	12	<b>1165.21</b>	25
<b>Pg 29</b>	Pg 29	19.0	27.5	38/40	45	12	<b>1165.29</b>	25
<b>Pg 36</b>	Pg 36	26.0	35.0	50	52	15	<b>1165.36</b>	10
<b>Pg 48</b>	Pg 48	37.0	49.0	65	56	15	<b>1165.48</b>	5

Erhältlich mit Dichteinsatz gemäss EN 45545. Bei Anfragen oder Bestellung bitte ein F vor die Artikelnummer setzen.

Available with sealing inserts conformity with EN 45545. When placing an inquiry, prefix the article number by the capital F.





# AGRO Kombi-Schlauchverschraubung Progress® EMV Messing mit integrierter Kabelverschraubung

## AGRO combination conduit glands Progress® EMC nickel-plated brass with integrated cable gland

Langes Anschlussgewinde metrisch | Long entry thread metric

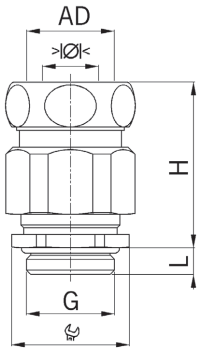

Material:	Messing vernickelt	Material:	Nickel-plated brass
Dichtung:	TPE	Seal:	TPE
O-Ring:	NBR	O-ring:	NBR
Zugentlastung:	Ausführung A nach EN 62444	Strain relief:	Version A acc. to EN 62444
Eigenschaften:	Sehr guter Schirmkontakt über die Kontakthülse bei in der Kabelverschraubung endendem Schirmgeflecht	Properties:	Excellent shield contact through the contact sleeve with the braided shield terminating in the screwed cable gland
Schutzart:	Kabelverschraubung IP 68	Protection class:	Cable gland IP 68
Einsatztemperatur:	-40°C / +100°C	Temperature range:	-40°C / +100°C
Hinweis:	Der max. Klemmbereich ist abhängig vom Schlauch-Innen-durchmesser	Note:	The max. clamping range depends on the conduit inner diameter

### Progress MS Kombi EMC



Einteiliger Dichteinsatz  
nicht durchgehend isolierend

One-piece sealing insert  
not overall length insulated

G	AD mm	>Ø< min mm	>Ø< max mm	mm	H mm	L mm	Art.-Nr.   Art. No.	
M12x1.5	10	4.5	6.0	15-17	35	10	1710.80.12.060.1	25
M16x1.5	14	6.0	8.0	18/21	40	10	1710.80.17.080.1	25
M16x1.5	14	8.0	10.0	18/21	40	10	1710.80.17.100.1	25
M20x1.5	17	8.0	11.0	24/25	42	10	1710.80.20.110.1	25
M20x1.5	17	11.0	14.0	24/25	42	10	1710.80.20.140.1	25
M20x1.5	19	8.0	11.0	24/27	43	10	1710.80.20.110.2	25
M20x1.5	19	11.0	14.0	24/27	43	10	1710.80.20.140.2	25
M25x1.5	21	13.0	16.0	30/29	48	11	1710.80.25.160.1	25
M25x1.5	27	16.0	19.0	30/36	52	11	1710.80.25.190.1	25
M32x1.5	27	18.0	21.0	36/36	55	13	1710.80.32.210.1	10
M32x1.5	27	21.0	25.0	36/36	55	13	1710.80.32.250.1	10
M40x1.5	36	24.0	28.5	46/45	60	13	1710.80.40.285.1	10
M40x1.5	36	28.5	32.0	46/45	60	13	1710.80.40.320.1	10
M50x1.5	45	33.0	37.0	55/54	62	14	1710.80.50.370.1	5
M50x1.5	45	37.0	41.0	55/54	62	14	1710.80.50.410.1	5
M63x1.5	56	40.0	46.0	70/66	69	14	1710.80.63.460.1	5
M63x1.5	56	46.0	50.0	70/66	69	14	1710.80.63.500.1	5

Je nach Schlauchtyp muss die passende Stabilisierungshülse separat bestellt werden.

Depending on the type of conduit, the stabilising bush must be ordered separately.

Erhältlich mit Dichteinsatz gemäss EN 45545. Bei Anfragen oder Bestellung bitte ein F vor die Artikelnummer setzen.

Available with sealing inserts conformity with EN 45545. When placing an inquiry, prefix the article number by the capital F.

# AGRO Kombi-Schlauchverschraubung Progress® EMV Messing mit integrierter Kabelverschraubung

## AGRO combination conduit glands Progress® EMC nickel-plated brass with integrated cable gland

Langes Anschlussgewinde metrisch | Long entry thread metric

Material: Messing vernickelt  
 Dichtung: TPE  
 O-Ring: NBR  
 Zugentlastung: Ausführung A nach EN 62444  
 Eigenschaften: Sehr guter Schirmkontakt über die Kontakthülse bei in der Kabelverschraubung endendem Schirmgeflecht  
 Schutzart: Kabelverschraubung IP 68  
 Einsatztemperatur: -40°C / +100°C  
 Hinweis: Der max. Klemmbereich ist abhängig vom Schlauch-Innen-durchmesser

Material: Nickel-plated brass  
 Seal: TPE  
 O-ring: NBR  
 Strain relief: Version A acc. to EN 62444  
 Properties: Excellent shield contact through the contact sleeve with the braided shield terminating in the screwed cable gland  
 Protection class: Cable gland IP 68  
 Temperature range: -40°C / +100°C  
 Note: The max. clamping range depends on the conduit inner diameter

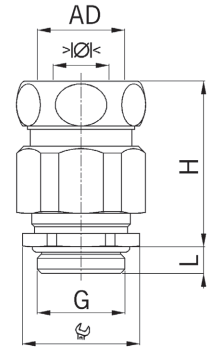

### Progress MS Kombi EMC



Einteiliger Dichteinsatz  
 nicht durchgehend isolierend

One-piece sealing insert  
 not overall length insulated

G	AD mm	>Ø< min mm	>Ø< max mm	Ø mm	H mm	L mm	Art.-Nr.   Art. No.	
M16x1.5	5/16"	6.0	8.0	18/21	38	10	1710.80.17.080.2	25
M16x1.5	5/16"	8.0	10.0	18/21	38	10	1710.80.17.100.2	25
M20x1.5	3/8"	8.0	11.0	24/27	42	10	1710.80.20.110.3	25
M20x1.5	1/2"	8.0	11.0	24/29	38	10	1710.80.20.110.4	25
M20x1.5	1/2"	11.0	14.0	24/29	38	10	1710.80.20.140.4	25
M25x1.5	3/4"	13.0	16.0	30/36	52	11	1710.80.25.160.2	25
M25x1.5	3/4"	16.0	19.0	30/36	52	11	1710.80.25.190.2	25
M32x1.5	1"	18.0	21.0	36/45	55	13	1710.80.32.210.2	10
M32x1.5	1"	21.0	25.0	36/45	55	13	1710.80.32.250.2	10
M40x1.5	1 1/4"	24.0	28.5	46/54	62	13	1710.80.40.285.2	10
M40x1.5	1 1/4"	28.5	32.0	46/54	62	13	1710.80.40.320.2	10

Je nach Schlauchtyp muss die passende Stabilisierungshülse separat bestellt werden.

Depending on the type of conduit, the stabilising bush must be ordered separately.

Erhältlich mit Dichteinsatz gemäss EN 45545. Bei Anfragen oder Bestellung bitte ein F vor die Artikelnummer setzen.

Available with sealing inserts conformity with EN 45545. When placing an inquiry, prefix the article number by the capital F.



# AGRO Kombi-Schlauchverschraubung Progress® EMV Messing mit integrierter Kabelverschraubung

## AGRO combination conduit glands Progress® EMC nickel-plated brass with integrated cable gland

### Langes Anschlussgewinde Pg | Long entry thread Pg

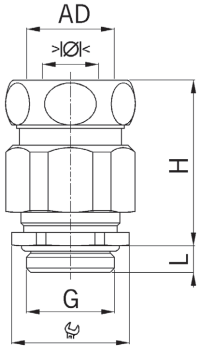

Material:	Messing vernickelt	Material:	Nickel-plated brass
Dichtung:	TPE	Seal:	TPE
O-Ring:	NBR	O-ring:	NBR
Zugentlastung:	Ausführung A nach EN 62444	Strain relief:	Version A acc. to EN 62444
Eigenschaften:	Sehr guter Schirmkontakt über die Kontakthülse bei in der Kabelverschraubung endendem Schirmgeflecht	Properties:	Excellent shield contact through the contact sleeve with the braided shield terminating in the screwed cable gland
Schutzart:	Kabelverschraubung IP 68	Protection class:	Cable gland IP 68
Einsatztemperatur:	-40°C / +100°C	Temperature range:	-40°C / +100°C
Hinweis:	Der max. Klemmbereich ist abhängig vom Schlauch-Innen-durchmesser	Note:	The max. clamping range depends on the conduit inner diameter

### Progress MS Kombi EMC



Einteiliger Dichteinsatz nicht durchgehend isolierend		One-piece sealing insert not overall length insulated				Art.-Nr.   Art. No.		
G	AD mm	>Ø< min mm	>Ø< max mm	 mm	H mm	L mm		
Pg 7	10	4.5	6.0	15/17	35	10	1710.80.07.060.1	25
Pg 9	14	6.0	8.0	18/21	40	10	1710.80.09.080.1	25
Pg 9	14	8.0	10.0	18/21	40	10	1710.80.09.100.1	25
Pg 11	17	8.5	12.0	21/25	41	10	1710.80.11.120.1	25
Pg 11	17	5.5	8.5	21/25	41	10	1710.80.11.085.1	25
Pg 13	19	8.0	11.0	24/27	42	10	1710.80.13.110.1	25
Pg 13	19	11.0	14.0	24/27	42	10	1710.80.13.140.1	25
Pg 16	21	8.0	11.0	24/29	43	10	1710.80.16.110.1	25
Pg 16	21	11.0	14.0	24/29	43	10	1710.80.16.140.1	25
Pg 21	27	13.0	16.0	30/36	55	12	1710.80.21.160.1	10
Pg 21	27	16.0	19.0	30/36	55	12	1710.80.21.190.1	10
Pg 29	36	19.0	23.0	38/45	57	12	1710.80.29.230.1	10
Pg 29	36	23.0	25.5	38/45	57	12	1710.80.29.255.1	10
Pg 36	45	25.0	30.5	50/54	62	15	1710.80.36.305.1	5
Pg 36	45	30.5	35.0	50/54	62	15	1710.80.36.350.1	5
Pg 42	45	33.0	37.0	55/54	62	15	1710.80.42.370.1	5
Pg 42	45	37.0	41.0	55/54	62	15	1710.80.42.410.1	5
Pg 48	56	39.0	43.0	65/66	69	15	1710.80.48.430.1	5
Pg 48	56	43.0	46.5	65/66	69	15	1710.80.48.465.1	5

Je nach Schlauchtyp muss die passende Stabilisierungshülse separat bestellt werden. Depending on the type of conduit, the stabilising bush must be ordered separately.

Erhältlich mit Dichteinsatz gemäss EN 45545. Bei Anfragen oder Bestellung bitte ein F vor die Artikelnummer setzen. Available with sealing inserts conformity with EN 45545. When placing an inquiry, prefix the article number by the capital F.

# AGRO Adapter Progress® Messing mit integrierter EMV-Kabelverschraubung

## AGRO adapters Progress® nickel-plated brass with integrated EMC cable gland

Langes Anschlussgewinde metrisch | Long entry thread metric

Material: Messing vernickelt  
 Kontakthülse: Messing vernickelt  
 Dichtung: TPE  
 O-Ring: NBR  
 Zugentlastung: Ausführung A nach EN 62444  
 Eigenschaften: Sehr guter Schirmkontakt über die Kontakthülse bei in der Kabelverschraubung endendem Schirmgeflecht  
 Schutzart: Kabelverschraubung IP 68  
 Einsatztemperatur: -40°C / +100°C  
 Hinweis: Der max. Klemmbereich ist abhängig vom Schlauch-Innendurchmesser

Material: Nickel-plated brass  
 Contact sleeve: Nickel-plated brass  
 Seal: TPE  
 O-ring: NBR  
 Strain relief: Version A acc. to EN 62444  
 Properties: Excellent shield contact through the contact sleeve with the braided shield terminating in the screwed cable gland  
 Protection class: Cable gland IP 68  
 Temperature range: -40°C / +100°C  
 Note: The max. clamping range depends on the conduit inner diameter

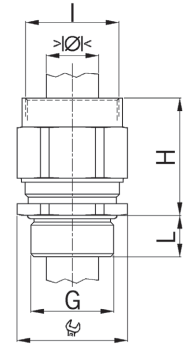

### Progress MS Kombi EMC



Einteiliger Dichteinsatz  
 nicht durchgehend isolierend

One-piece sealing insert  
 not overall length insulated

G	I	>Ø< min mm	>Ø< max mm	mm	H mm	L mm	i info	Art.-Nr.   Art. No.	
M10x1.5	M10x1.5	3.0	4.0	13	32	10	1	1165.80.10.040	50
M10x1.5	M10x1.5	4.0	6.0	13	32	10	1	1165.80.10.060	50
M12x1.5	M12x1.5	4.5	6.0	15	34	10	-	1165.80.12.060	50
M12x1.5	M12x1.5	6.0	7.5	15	34	10	-	1165.80.12.075	50
M16x1.5	M16x1.5	6.0	8.0	18	38	10	-	1165.80.17.080	50
M16x1.5	M16x1.5	8.0	10.0	18	38	10	-	1165.80.17.100	50
M20x1.5	M20x1.5	8.0	11.0	24	40	10	-	1165.80.20.110	25
M20x1.5	M20x1.5	11.0	14.0	24	40	10	-	1165.80.20.140	25
M25x1.5	M25x1.5	13.0	16.0	30	46	11	-	1165.80.25.160	25
M25x1.5	M25x1.5	16.0	19.0	30	46	11	-	1165.80.25.190	25
M32x1.5	M32x1.5	18.0	21.0	36	49	13	-	1165.80.32.210	10
M32x1.5	M32x1.5	21.0	25.0	36	49	13	-	1165.80.32.250	10
M40x1.5	M40x1.5	24.0	28.5	46	51	13	-	1165.80.40.285	10
M40x1.5	M40x1.5	28.5	32.0	46	51	13	-	1165.80.40.320	5
M50x1.5	M50x1.5	33.0	37.0	55	55	14	-	1165.80.50.370	5
M50x1.5	M50x1.5	37.0	41.0	55	55	14	-	1165.80.50.410	5
M63x1.5	M63x1.5	40.0	46.0	70	59	14	-	1165.80.63.460	5
M63x1.5	M63x1.5	46.0	50.0	70	59	14	-	1165.80.63.500	5



1 = Metrisches Regelgewinde (mit VDE Testreport)

1 = Metric coarse-pitch thread (with VDE test report)

Erhältlich mit Dichteinsatz gemäss EN 45545. Bei Anfragen oder Bestellung bitte ein F vor die Artikelnummer setzen.

Available with sealing inserts conformity with EN 45545. When placing an inquiry, prefix the article number by the capital F.

# AGRO Adapter Progress® Messing mit integrierter EMV-Kabelverschraubung

## AGRO adapters Progress® nickel-plated brass with integrated EMC cable gland

### Langes Anschlussgewinde Pg | Long entry thread Pg

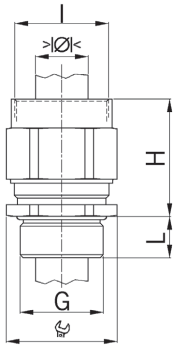

Material:	Messing vernickelt	Material:	Nickel-plated brass
Kontakthülse:	Messing vernickelt	Contact sleeve:	Nickel-plated brass
Dichtung:	TPE	Seal:	TPE
O-Ring:	NBR	O-ring:	NBR
Zugentlastung:	Ausführung A nach EN 62444	Strain relief:	Version A acc. to EN 62444
Eigenschaften:	Sehr guter Schirmkontakt über die Kontakthülse bei in der Kabelverschraubung endendem Schirmgeflecht	Properties:	Excellent shield contact through the contact sleeve with the braided shield terminating in the screwed cable gland
Schutzart:	Kabelverschraubung IP 68	Protection class:	Cable gland IP 68
Einsatztemperatur:	-40°C / +100°C	Temperature range:	-40°C / +100°C
Hinweis:	Der max. Klemmbereich ist abhängig vom Schlauch-Innen-durchmesser	Note:	The max. clamping range depends on the conduit inner diameter

### Progress MS Kombi EMC



Einteiliger Dichteinsatz nicht durchgehend isolierend							One-piece sealing insert not overall length insulated	
G	I	$\gt\varnothing<$ min mm	$\gt\varnothing<$ max mm	$\varnothing_{\text{hr}}$ mm	H mm	L mm	Art.-Nr.   Art. No.	
Pg 7	Pg 7	4.0	6.0	15	31	10	1165.80.07.060	50
Pg 7	Pg 7	6.0	7.5	15	31	10	1165.80.07.075	50
Pg 9	Pg 9	6.0	8.0	18	38	10	1165.80.09.080	50
Pg 9	Pg 9	8.0	10.0	18	38	10	1165.80.09.100	50
Pg 11	Pg 11	5.5	8.5	21	38	10	1165.80.11.085	50
Pg 11	Pg 11	8.5	12.0	21	38	10	1165.80.11.120	50
Pg 13	Pg 13	8.0	11.0	24	40	10	1165.80.13.110	25
Pg 13	Pg 13	11.0	14.0	24	40	10	1165.80.13.140	25
Pg 16	Pg 16	8.0	11.0	24	41	10	1165.80.16.110	25
Pg 16	Pg 16	11.0	14.0	24	41	10	1165.80.16.140	25
Pg 21	Pg 21	13.0	16.0	30	47	12	1165.80.21.160	10
Pg 21	Pg 21	16.0	19.0	30	47	12	1165.80.21.190	10
Pg 29	Pg 29	19.0	23.0	38/40	48	12	1165.80.29.230	10
Pg 29	Pg 29	23.0	25.5	38/40	48	12	1165.80.29.255	10
Pg 36	Pg 36	25.0	30.5	50	54	15	1165.80.36.305	10
Pg 36	Pg 36	30.5	35.0	50	54	15	1165.80.36.350	10
Pg 48	Pg 48	39.0	43.0	65	59	15	1165.80.48.430	5
Pg 48	Pg 48	43.0	46.5	65	59	15	1165.80.48.465	5

Erhältlich mit Dichteinsatz gemäss EN 45545. Bei Anfragen oder Bestellung bitte ein F vor die Artikelnummer setzen.

Available with sealing inserts conformity with EN 45545. When placing an inquiry, prefix the article number by the capital F.

### Anschlussgewinde metrisch | Entry thread metric

Material:	Messing vernickelt	Material:	Nickel-plated brass
Kontakthülse:	Messing vernickelt	Contact sleeve:	Nickel-plated brass
O-Ring:	NBR	O-ring:	NBR
Schutzart:	IP 68 (mit Rohrflex®-Ringwellschlauch)	Protection class:	IP 68 (together with Rohrflex® corrugated tube)
Einsatztemperatur:	-40°C / +120°C	Temperature range:	-40°C / +120°C

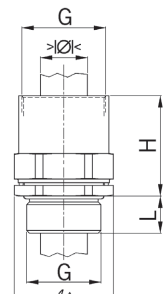

Passend zu ROHRflex® Wellschlauch						Suitable for ROHRflex® corrugated tubings	
G	$\gt\varnothing<$ min mm	$\gt\varnothing<$ max mm	$\varnothing_{\text{hr}}$ mm	H mm	L mm	Art.-Nr.   Art. No.	
M20x1.5	2.5	10.0	24	34.5	10	1165.84.20.15	25
M25x1.5	5.0	16.0	30	35.5	11	1165.84.25.21	25
M32x1.5	12.0	20.0	36	36.5	13	1165.84.32.34	25
M40x1.5	16.0	27.0	46	45	13	1165.84.40.34	10
M50x1.5	20.0	35.0	55	46	14	1165.84.50.42	5
M63x1.5	25.0	45.0	70	49	14	1165.84.63.54	5





# AGRO Brandschott Adapter ADMF

## AGRO fire protection adapter ADMF

### Intumeszierende Hülse | Intumescent sleeve

Material: Messing vernickelt  
 Hülse: Intumeszierendes Material  
 Eigenschaften: Brandschott Adapter für durchgeführte Kabel, Brandschott Hülse mit intumeszierendem Material, Auslösung ab ca. 150°C  
 Einsatzbereich: Min. 30 min. Feuerschutz (E30) nach EN 45545-3 (HL3) nach EN 45545-2  
 Einsatztemperatur: -40°C / +600°C  
 Schutzart: IP 68

Material: Nickel-plated brass  
 Sleeve: Nickel-plated brass  
 Properties: Fire barrier for inserted cables. fire protection, sleeve with intumescent material, thermal expansion from approx. +150°C  
 Application: Fire protection of min. 30 min. (E30) according to EN 45545-3 (HL3) according to EN 45545-2  
 Temperature range: -40°C / +600°C  
 Protection class: IP 68

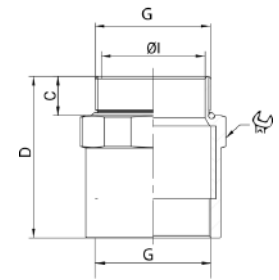

AG	IG	ØI mm	C mm	D mm	mm	Art.-Nr.   Art. No.	
M16x1.5	M16x1.5	13.0	12	38.5	22	5010.033.016	25
M20x1.5	M20x1.5	16.5	12	41.0	27	5010.033.020	25
M25x1.5	M25x1.5	21.0	13	49.0	32	5010.033.025	10
M32x1.5	M32x1.5	27.5	14	52.5	41	5010.033.032	10
M40x1.5	M40x1.5	35.0	17	63.5	46	5010.033.040	2
M50x1.5	M50x1.5	45.0	17	70.0	60	5010.033.050	2



Der intumeszierende Einlegering reagiert bei einer Temperatur von ca. +150°C und verschliesst den Durchgang.

The intumescent insert ring reacts at a temperature of approx. +150°C and closes the pass.

# Schlauchverschraubung Winkel 90° Messing

## 90° elbow conduit connectors nickel-plated brass

### Kurzes Anschlussgewinde metrisch | Short entry thread metric

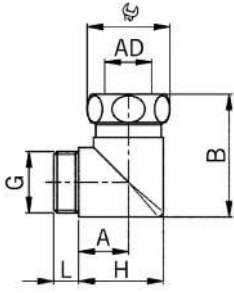

Material: Messing vernickelt  
 Dichtung: TPE  
 O-Ring: Separat bestellen  
 Schutzart: IP 40 - IP 66, abhängig von der Kombination Schlauch und Verschraubung  
 Einsatztemperatur: -40°C / +125°C

Material: Nickel-plated brass  
 Seal: TPE  
 O-ring: To be ordered separately  
 Protection class: IP 40 - IP 66, in dependence of the combination of conduit and connector  
 Temperature range: -40°C / +125°C



Schlauchverschraubung Winkel 90° Messing

90° elbow conduit connectors nickel-plated brass

AD mm	G	A mm	B mm	H mm	L mm		Art.-Nr.   Art. No.	
10	M12x1.5	11	32	21	8	17	5000.12.10	50
14	M16x1.5	13	36	25	8	21	5000.17.14	50
17	M20x1.5	15	38	29	8	25	5000.20.17	50
19	M20x1.5	16	41	31	8	27	5000.20.19	50
21	M25x1.5	17	45	33	10	29	5000.25.21	50
27	M32x1.5	21	57	40	10	36	5000.32.27	25
36	M40x1.5	26	67	50	10	45	5000.40.36	25
45	M50x1.5	30	77	59	12	54	5000.50.45	10
56	M63x1.5	37	93	72	12	66	5000.63.56	5

Technischer Hinweis

Technical note

Je nach Schlauchtyp muss die passende Stabilisierungshülse separat bestellt werden.

Depending on the type of conduit, the stabilising bush must be ordered separately.

### Langes Anschlussgewinde metrisch | Long entry thread metric



Schlauchverschraubung Winkel 90° Messing

90° elbow conduit connectors nickel-plated brass

AD mm	G	A mm	B mm	H mm	L mm		Art.-Nr.   Art. No.	
10	M12x1.5	11	32	21	12	17	5100.12.10	50
14	M16x1.5	13	36	25	12	21	5100.17.14	50
17	M20x1.5	15	38	29	12	25	5100.20.17	50
19	M20x1.5	16	41	31	12	27	5100.20.19	50
21	M25x1.5	17	45	33	14	29	5100.25.21	50
27	M32x1.5	21	57	40	16	36	5100.32.27	25
36	M40x1.5	26	67	50	16	45	5100.40.36	25
45	M50x1.5	30	77	59	18	54	5100.50.45	10
56	M63x1.5	37	93	72	18	66	5100.63.56	5

Technischer Hinweis

Technical note

Je nach Schlauchtyp muss die passende Stabilisierungshülse separat bestellt werden.

Depending on the type of conduit, the stabilising bush must be ordered separately.



Schlauchverschraubung Winkel 90° Messing  
Kurzes Anschlussgewinde Pg

90° elbow conduit connectors nickel-plated brass  
Short entry thread Pg

AD mm	G	A mm	B mm	H mm	L mm		Art.-Nr.   Art. No.	
10	Pg 7	11	32	21	8	17	5000.07.10	50
14	Pg 9	13	36	25	8	21	5000.09.14	50
17	Pg 11	15	38	29	8	25	5000.11.17	50
19	Pg 13	16	41	31	10	27	5000.13.19	50
21	Pg 16	17	45	33	10	29	5000.16.21	50
27	Pg 21	21	57	40	10	36	5000.21.27	25
36	Pg 29	26	67	50	10	45	5000.29.36	25
45	Pg 36	30	77	59	12	54	5000.36.45	10
56	Pg 48	37	93	72	12	66	5000.48.56	5

Technischer Hinweis

Technical note

Je nach Schlauchtyp muss die passende Stabilisierungshülse separat bestellt werden.

Depending on the type of conduit, the stabilising bush must be ordered separately.

# Kunststoff Schlauchverschraubung gerade

## Synthetic straight conduit connector

### Anschlussgewinde metrisch | Entry thread metric



Material: Polypropylen schlagfest  
 Hülse: Polypropylen  
 Dichtring: TPE  
 Eigenschaften: Hoher Staub- und Flüssigkeitsschutz, kraftschlüssige Verbindung von Schlauch und Verschraubung, Abdeckung der Schlauchenden, vibrations- und zugfest

Schutzart: IP 54  
 Einsatztemperatur: -10°C / +110°C

Material: Polypropylene impact-resistant  
 Bushing: Polypropylene  
 Sealing ring: TPE  
 Properties: Highly watertight and dust-proof, friction locking of conduit and gland, covered conduit ends, resistant to stretch and vibrations

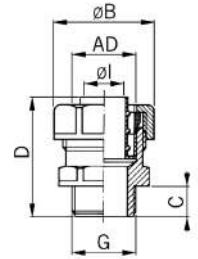
Protection class: IP 54  
 Temperature range: -10°C / +110°C



Kunststoff-Schlauchverschraubung USK-M AIRflex-KUW-PU-AS / -KUW-PVC-AS / -GRS							Synthetic conduit connector USK-M AIRflex-KUW-PU-AS / -KUW-PVC-AS / -GRS	
AD mm	G	ØI mm	ØB mm	C mm	D mm	 mm	Art.-Nr.   Art. No.	
10	M10x1.0	6.0	20	10	40	16	5020.330.010	50
14	M12x1.5	8.0	25	12	43	21	5020.330.012	50
17	M16x1.5	11.0	30	12	43	24	5020.330.016	50
21	M20x1.5	15.5	35	13	44	29	5020.330.020	50
27	M25x1.5	20.0	44	13	50	36	5020.330.025	25
36	M32x1.5	27.0	54	15	51	45	5020.330.032	25
45	M40x1.5	35.0	63	15	51	54	5020.330.040	25
56	M50x1.5	44.5	77	16	58	66	5020.330.050	10



#### Technischer Hinweis



Die Funktionssicherheit ist nur gewährleistet bei Verwendung der passenden Stabilisierungshülse

#### Technical note

The reliability is only guaranteed with the corresponding stabilizing bush

### Anschlussgewinde Pg | Entry thread Pg



Kunststoff-Schlauchverschraubung USK-P AIRflex-KUW-PU-AS / -KUW-PVC-AS / -GRS							Synthetic conduit connector USK-P AIRflex-KUW-PU-AS / -KUW-PVC-AS / -GRS	
AD mm	G	ØI mm	ØB mm	C mm	D mm	 mm	Art.-Nr.   Art. No.	
10	Pg 7	6.0	20	10	40	16/18	5020.130.007	50
14	Pg 9	9.0	25	10	41	21/23	5020.130.009	50
17	Pg 11	11.0	30	10	41	24/27	5020.130.011	50
19	Pg 13	13.0	32	10	41	26/29	5020.130.013	50
21	Pg 16	14.5	35	11	42	29/32	5020.130.016	50
27	Pg 21	19.5	44	11	48	36/40	5020.130.021	25
36	Pg 29	27.0	54	12	48	45/49	5020.130.029	25
45	Pg 36	36.0	63	12	48	53/58	5020.130.036	20
56	Pg 48	46.0	77	15	57	65/70	5020.130.048	10



#### Technischer Hinweis

Die Funktionssicherheit ist nur gewährleistet bei Verwendung der passenden Stabilisierungshülse

#### Technical note

The reliability is only guaranteed with the corresponding stabilizing bush

# Kunststoff-Schlauchverschraubung drehbar

## Swivelling synthetic conduit connectors

### Anschlussgewinde metrisch | Entry thread metric

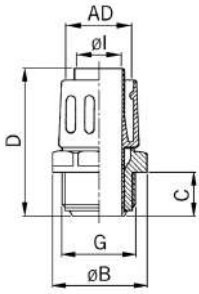



Material: Polypropylen schlagfest  
 Hülse: Polypropylen  
 Eigenschaften: Schlauchausdrehenschutz, als Abdeckung der Schlauchenden, vibrations- und zugfest  
 Schutzart: IP 54  
 Einsatztemperatur: -10°C / +110°C

Material: Polypropylene impact-resistant  
 Bushing: Polypropylene  
 Properties: Conduit screw-out-locking, covered conduit ends, resistant to stretch and vibrations  
 Protection class: IP 54  
 Temperature range: -10°C / +110°C



Kunststoff-Schlauchverschraubung LKI-M  
 AIRflex-KUW-PU-AS / -KUW-PVC-AS / -GRS

Synthetic conduit connector LKI-M  
 AIRflex-KUW-PU-AS / -KUW-PVC-AS / -GRS

AD mm	G	øI mm	øB mm	C mm	D mm	 mm	Art.-Nr.   Art. No.	
10	M12x1.5	5.5	17.5	10	38.0	16	5020.014.012	50
14	M16x1.5	9.5	21.0	10	39.5	19	5020.014.016	50
17	M20x1.5	11.5	24.5	10	42.0	22	5020.014.020	50
21	M25x1.5	14.5	30.0	11	48.0	27	5020.014.025	50
27	M32x1.5	19.5	39.0	12	58.0	35	5020.014.032	25
36	M40x1.5	27.0	50.0	12	59.0	45	5020.014.040	25
45	M50x1.5	35.5	59.5	12	62.5	54	5020.014.050	25
56	M63x1.5	46.0	71.5	15	68.0	65	5020.014.063	10

Technischer Hinweis

Die Funktionssicherheit ist nur gewährleistet bei Verwendung der passenden Stabilisierungshülse

Technical note



The reliability is only guaranteed with the corresponding stabilizing bush

### Anschlussgewinde Pg | Entry thread Pg



Kunststoff-Schlauchverschraubung LKI-P  
 AIRflex-KUW-PU-AS / -KUW-PVC-AS / -GRS

Synthetic conduit connector LKI-P  
 AIRflex-KUW-PU-AS / -KUW-PVC-AS / -GRS

AD mm	G	øI mm	øB mm	C mm	D mm	 mm	Art.-Nr.   Art. No.	
10	Pg 7	5.5	17.5	10	38.0	16	5020.010.007	50
14	Pg 9	9.5	21.0	10	39.5	19	5020.010.009	50
17	Pg 11	11.5	24.5	10	42.0	22	5020.010.011	50
19	Pg 13	13.0	26.5	10	42.0	24	5020.010.013	50
21	Pg 16	14.5	30.0	11	48.0	27	5020.010.016	50
27	Pg 21	19.5	39.0	11	58.0	35	5020.010.021	25
36	Pg 29	27.0	50.0	12	59.0	45	5020.010.029	25
45	Pg 36	35.5	59.5	12	62.5	54	5020.010.036	25
56	Pg 48	46.0	71.5	15	68.0	65	5020.010.048	10

Technischer Hinweis

Die Funktionssicherheit ist nur gewährleistet bei Verwendung der passenden Stabilisierungshülse

Technical note

The reliability is only guaranteed with the corresponding stabilizing bush



Metallschutzschlauch flüssigkeitsdicht Liquid tight Protective metal conduits liquid-proof LIQUID-TIGHT	 <b>131 - 132</b>	1
AGRO Kombi-Schlauchverschraubung Progress® Messing mit integrierter Kabelverschraubung AGRO combination conduit glands Progress® nickel-plated brass with integrated cable gland	 <b>133</b>	2
Schlauchverschraubung Messing vernickelt Conduit glands nickel-plated brass	 <b>134</b>	3
Schlauchverschraubung Winkel 45° Messing vernickelt Conduit glands angle 45° steel nickel-plated brass	 <b>135</b>	4
Schlauchverschraubung Winkel 90° Messing vernickelt Conduit glands angle 90° steel nickel-plated brass	 <b>136</b>	5
Stabilisierungshülse Stabilizing bush	 <b>137</b>	6

- 1
- 2
- 3
- 4
- 5
- 6
- 7
- 8**
- 9
- 10
- 11
- 12



## Liquid tight Metallschutzschläuche und Verschraubungen

### Protective metal conduits liquid-tight and conduit glands



**Liquid Tight** Metallschutzschläuche und Verschraubungen sind ideal für extrem hohe mechanische Belastungen im Maschinen und Anlagenbau.

Der spezielle Aufbau der Schläuche ist für besonders flüssigkeitsdichte Installationen gemäss amerikanischen Vorschriften geeignet.

#### Wichtigste Eigenschaften

- Zugfest und querdruckbelastbar
- Für schwere mechanische Beanspruchung
- Gute Laugen- und Säurenbeständigkeit
- UL und CSA Zulassung

**Liquid Tight** metal protective conduits and conduit glands are ideal for extremely high mechanical stress on machines and plants.

The special construction of the conduits excels at liquid-tight installations according to American installation specifications.

#### Key properties

- Withstand high tensile stress and are crush-resistant
- Designed to handle heavy mechanical loads
- High resistance to acids and alkaline substances
- Approvals UL and CSA

# Metallschutzschläuche flüssigkeitsdicht LIQUID-TIGHT

## Protective metal conduits liquid-proof LIQUID-TIGHT

LIQUID-TIGHT-UL / CSA | LIQUID-TIGHT-UL / CSA

Material:	Wendelgewickelter Stahlschlauch, erhöhte Zinkauflage, eingearbeiteter Kupfer-Erdleiter bis Grösse 1¼"	Material:	Strip-wound metallic conduit with elevated zinc deposit, incorporated copper ground lead up to dim. 1¼"
Aussenmantel:	PVC verstärkt, flammwidrig	Sheathing:	Reinforced, flame resistant PVC
Eigenschaften:	Besonders stabiler, biegsamer Metallschlauchkern, flexibel, flüssigkeitsdicht, weitgehend säure- und ölbeständig, silikon- und cadmiumfrei	Properties:	Extremely solid flexible metal conduit core, liquid-tight, widely resistant to oil and acids, free of silicone and cadmium
Einsatzbereich:	Für extrem hohe mechanische Belastung an Maschinen und Anlagen	Application:	For extremely high mechanical stress on machines and plants
Zulassung:	UL-File No. E 51430 by the Underwriters Laboratories Inc. acc. to UL 360 / CSA-File No. 29576 by the Canadian Standards Association acc. to C 22.2 No.56-04	Approval:	UL-File No. E 51430 by the Underwriters Laboratories Inc. acc. to UL 360 / CSA-File No. 29576 by the Canadian Standards Association acc. to C 22.2 No.56-04
Schutzart:	IP 68	Protection class:	IP 68
Einsatztemperatur:	-25°C / +90°C / ^ +100°C	Temperature range:	-25°C / +90°C / ^ +100°C

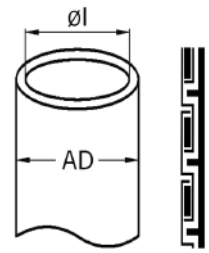

Metallschutzschläuche flüssigkeitsdicht LIQUID-TIGHT-UL / CSA		Protective metal conduit liquid-tight LIQUID-TIGHT-UL / CSA		Schwarz Black		Hülse Douille/Bush		Art.-Nr.   Art. No.		
AD mm	øI mm	øA mm	R±10% stat mm	R±10% dyn mm						
3/8"	12.5	18.0	140	350	0601.000.011			<b>2060.112.012</b>		50
1/2"	16.0	21.0	175	430	0601.000.016			<b>2060.112.016</b>		50
3/4"	21.0	26.5	180	450	0601.000.021			<b>2060.112.021</b>		50
1"	26.5	33.0	230	575	0601.000.029			<b>2060.112.026</b>		25
1 1/4"	35.5	42.0	260	650	0601.000.036			<b>2060.112.035</b>		25
2"	51.5	60.0	360	850	0601.000.048			<b>0621.000.051</b>		15



# Metallschutzschläuche flüssigkeitsdicht LIQUID-TIGHT

## Protective metal conduits liquid-proof LIQUID-TIGHT

### LIQUID-TIGHT-EF | LIQUID-TIGHT-EF

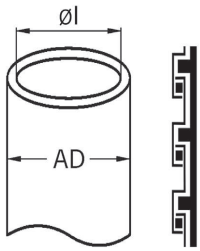

Material:	Stahl-Kaltband DC03 nach EN 10139, verzinkt, Spezialfaden-Dichtung	Material:	Cold strip DC03 acc. to EN 10139 galvanized, special fibre sealing
Aussenmantel:	PVC verstärkt, flammwidrig	Sheathing:	Reinforced, flame resistant PVC
Eigenschaften:	Besonders flüssigkeitsdicht, flexibel, weitgehend säure- und ölbeständig, silikon- und cadmiumfrei	Properties:	Especially liquid-tight, flexible, widely resistant to oil and acids, free of silicone and cadmium
Einsatzbereich:	Für erhöht flüssigkeitsdichte Installationen, entspricht den amerikanischen Installationsvorschriften	Application:	For installations requiring increased liquid tightness, especially for use in compliance with American installation specifications
Zulassung:	SETI-Approbation	Approval:	SETI approval
Geprüft:	Nach EN IEC 61386-23, Kennzeichen ASF	Approved:	Acc. to EN IEC 61386-23, mark ASF
Schutzart:	IP 68	Protection class:	IP 68
Einsatztemperatur:	-25°C / +90°C / ^ +100°C	Temperature range:	-25°C / +90°C / ^ +100°C



Metallschutzschlauch flüssigkeitsdicht LIQUID-TIGHT-EF Grau		Protective metal conduit liquid-tight LIQUID-TIGHT-EF Grey					Art.-Nr.   Art. No.		
AD mm	øI mm	øA mm	R±10% stat mm	R±10% dyn mm	Hülse Douille/Bush				
5/16"	10.0	14.5	105	165	5031.028.009	<b>2080.111.010</b>		50	
3/8"	12.5	18.0	145	360	0601.000.011	<b>2080.111.012</b>		50	
1/2"	16.0	21.0	170	425	0601.000.016	<b>2080.111.016</b>		50	
3/4"	21.0	26.5	190	475	0601.000.021	<b>2080.111.021</b>		50	
1"	26.5	33.0	195	490	0601.000.029	<b>2080.111.026</b>		25	
1 1/4"	35.5	42.0	250	625	0601.000.036	<b>2080.111.035</b>		25	
2"	51.5	60.0	320	780	0601.000.048	<b>2080.111.050</b>		25	

# Kombi-Schlauchverschraubung mit integrierter Kabelverschraubung

## Combination conduit gland with integrated cable gland

### Kurzes Anschlussgewinde metrisch | Short entry thread metric

Material: Messing vernickelt  
 Dichtung: TPE  
 O-Ring : NBR  
 Zugentlastung: Ausführung A nach EN 62444  
 Schutzart: Kabelverschraubung IP 68  
 Einsatztemperatur: -40°C / +100°C  
 Hinweis: Der max. Klemmbereich ist abhängig vom Schlauch-Innen-durchmesser

Material: Nickel-plated brass  
 Seal: TPE  
 O-ring : NBR  
 Strain relief: Version A acc. to EN 62444  
 Protection class: Cable gland IP 68  
 Temperature range: -40°C / +100°C  
 Note: The max. clamping range depends on the conduit inner diameter

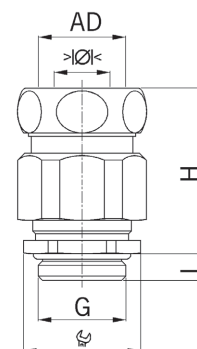

zu LIQUID-TIGHT-Schutzschläuchen  
 Zweiteiliger Dichteinsatz  
 LIQUID-TIGHT-UL / CSA / -EF

for LIQUID-TIGHT protective conduits  
 Two-piece sealing insert  
 LIQUID-TIGHT-UL / CSA / -EF

G	AD mm	>Ø< min mm	>Ø< max mm	Ø mm	H mm	L mm	Art.-Nr.   Art. No.	
M20x1.5	3/8"	8.0	15.0	24/27	42	6	1700.20.3/8	25
M20x1.5	1/2"	8.0	15.0	24/29	38	6	1700.20.1/2	25
M25x1.5	3/4"	12.5	20.5	30/36	52	7	1700.25.3/4	25
M32x1.5	1"	17.0	25.5	36/45	55	8	1700.32.1	25

Die Schutzart des Schlauchanschlusses ist abhängig von der Wahl des Schlauchtyps

The protection class of the conduit fitting depends on the selection of the type of conduit



### Langes Anschlussgewinde metrisch | Long entry thread metric

zu LIQUID-TIGHT-Schutzschläuchen  
 Zweiteiliger Dichteinsatz  
 LIQUID-TIGHT-UL / CSA / -EF

for LIQUID-TIGHT protective conduits  
 Two-piece sealing insert  
 LIQUID-TIGHT-UL / CSA / -EF

G	AD mm	>Ø< min mm	>Ø< max mm	Ø mm	H mm	L mm	Art.-Nr.   Art. No.	
M16x1.5	14	6.0	10.5	18/21	38	10	1710.60.17.14	50
M20x1.5	3/8"	8.0	14.5	24/27	42	10	1710.60.20.3/8	25
M20x1.5	1/2"	8.0	14.5	24/29	38	10	1710.60.20.1/2	25
M25x1.5	3/4"	12.5	19.0	30/36	52	11	1710.60.25.3/4	25
M32x1.5	1"	17.0	19.0	36/45	55	13	1710.60.32.1	25

Die Schutzart des Schlauchanschlusses ist abhängig von der Wahl des Schlauchtyps

The protection class of the conduit fitting depends on the selection of the type of conduit



# Schlauchverschraubung Messing komplett

## Complete conduit gland nickel-plated brass

### Anschlussgewinde metrisch | Entry thread metric

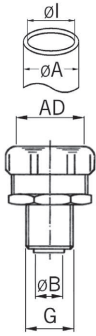

Material: Messing vernickelt  
 Dichtring: Polyamid PA 6  
 Eigenschaften: Hoher Staub- und Flüssigkeitsschutz, kraftschlüssige Verbindung von Schlauch und Verschraubung, einwandfreie Erdung, Abdeckung der Schlauchenden, vibrations- und zugfest  
 Einsatzbereich: Installationen nach amerikanischen und kanadischen Installationsvorschriften, Maschinen- und Anlagenbau  
 Schutzart: IP 67  
 Einsatztemperatur: -45°C / 105°C

Material: Nickel-plated brass  
 Sealing ring: Polyamide PA 6  
 Properties: Highly watertight and dust-proof, friction locking of conduit and gland, proper earthing, covered conduit ends, resistant to stretch and vibrations  
 Application: Installation according to US and Canadian specifications, for use in machinery and installations  
 Protection class: IP 67  
 Temperature range: -45°C / 105°C



Schlauchverschraubung EG-M zu LIQUID-TIGHT-Schutzschläuchen LIQUID-TIGHT-UL / CSA / -EF		Conduit gland EG-M for LIQUID-TIGHT protective conduits LIQUID-TIGHT-UL / CSA / -EF							Art.-Nr.   Art. No.	📦
AD mm	G	ØI mm	ØA mm	ØB mm	C mm	U <sub>1</sub> mm	U <sub>2</sub> mm			
3/8"	M16x1.5	12.5	18.0	10.2	12	26	24	0608.000.016	10	
3/8"	M20x1.5	12.5	18.0	10.2	13	26	24	0608.000.020	10	
1/2"	M20x1.5	16.0	21.0	13.9	13	29	27	0608.000.021	10	
3/4"	M25x1.5	21.0	26.5	18.5	15	35	33	0608.000.025	5	
1"	M32x1.5	26.5	33.0	23.8	15	45	43	0608.000.032	5	

Die Schutzart des Schlauchanschlusses ist abhängig von der Wahl des Schlauchtyps

The protection class of the conduit fitting depends on the selection of the type of conduit

### Anschlussgewinde Pg | Entry thread Pg



Schlauchverschraubung EG-P zu LIQUID-TIGHT-Schutzschläuchen LIQUID-TIGHT-UL / CSA / -EF		Conduit gland EG-P for LIQUID-TIGHT protective conduits LIQUID-TIGHT-UL / CSA / -EF							Art.-Nr.   Art. No.	📦
AD mm	G	ØI mm	ØA mm	ØB mm	C mm	U <sub>1</sub> mm	U <sub>2</sub> mm			
3/8"	Pg 11	12.5	18.0	10.2	12	26	24	0610.000.011	10	
3/8"	Pg 13	12.5	18.0	10.2	12	26	24	0610.000.013	10	
1/2"	Pg 16	16.0	21.0	13.4	13	29	27	0610.000.016	10	
3/4"	Pg 21	21.0	26.5	18.5	15	35	33	0610.000.021	5	
1"	Pg 29	26.5	33.0	23.8	15	45	43	0610.000.029	5	
1 1/4"	Pg 36	35.5	42.0	31.8	16	54	52	0610.000.036	2	
2"	Pg 48	51.5	60.0	47.8	20	77	74	0610.000.048	2	

Die Schutzart des Schlauchanschlusses ist abhängig von der Wahl des Schlauchtyps

The protection class of the conduit fitting depends on the selection of the type of conduit



# Winkelverschraubung 45° Messing komplett

## Complete angle conduit gland 45° nickel-plated brass

### Anschlussgewinde metrisch | Entry thread metric

Material:	Messing vernickelt	Material:	Nickel-plated brass
Dichtring:	Polyamid PA 6	Sealing ring:	Polyamide PA 6
Eigenschaften:	Hoher Staub- und Flüssigkeitsschutz, kraftschlüssige Verbindung von Schlauch und Verschraubung, einwandfreie Erdung, Abdeckung der Schlauchenden, vibrations- und zugfest	Properties:	Highly watertight and dust-proof, friction locking of conduit and gland, proper earthing, covered conduit ends, resistant to stretch and vibrations
Einsatzbereich:	Installationen nach amerikanischen und kanadischen Installationsvorschriften, Maschinen- und Anlagenbau	Application:	Installation according to US and Canadian specifications, for use in machinery and installations
Schutzart:	IP 67	Protection class:	IP 67
Einsatztemperatur:	-45°C / 105°C	Temperature range:	-45°C / 105°C

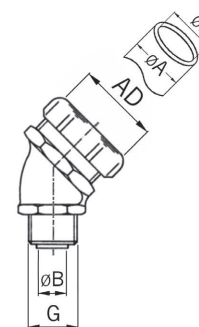

Schlauchverschraubung EW 45-M  
zu LIQUID-TIGHT-Schutzschläuchen  
LIQUID-TIGHT-UL / CSA / -EF

conduit gland EW 45-M  
for LIQUID-TIGHT protective conduits  
LIQUID-TIGHT-UL / CSA / -EF

AD mm	G	ØI mm	A mm	ØB mm	C mm	r <sub>1</sub> mm	r <sub>2</sub> mm	Art.-Nr.   Art. No.	
3/8"	M16x1.5	12.5	18.0	10.2	12	26	22	0609.000.016	10
3/8"	M20x1.5	12.5	18.0	10.2	12	26	22	0609.000.020	10
1/2"	M20x1.5	16.0	21.0	13.9	13	29	27	0609.000.021	10
3/4"	M25x1.5	21.0	26.5	18.5	15	35	33	0609.000.025	5
1"	M32x1.5	26.5	33.0	23.8	15	45	42	0609.000.032	5

Die Schutzart des Schlauchanschlusses ist abhängig von der Wahl des Schlauchtyps

The protection class of the conduit fitting depends on the selection of the type of conduit



### Anschlussgewinde Pg | Entry thread Pg



Schlauchverschraubung EW 45-P  
zu LIQUID-TIGHT-Schutzschläuchen  
LIQUID-TIGHT-UL / CSA / -EF

Conduit gland EW 45-P  
for LIQUID-TIGHT protective conduits  
LIQUID-TIGHT-UL / CSA / -EF

AD mm	G	ØI mm	ØA mm	ØB mm	C mm	r <sub>1</sub> mm	r <sub>2</sub> mm	Art.-Nr.   Art. No.	
3/8"	Pg 11	12.5	18.0	10.2	12	26	22	0611.000.011	10
3/8"	Pg 13	12.5	18.0	10.2	12	26	22	0611.000.013	10
1/2"	Pg 16	16.0	21.0	13.9	13	29	27	0611.000.016	10
3/4"	Pg 21	21.0	26.5	18.5	15	35	33	0611.000.021	5
1"	Pg 29	26.5	33.0	23.8	15	45	42	0611.000.029	5
1 1/4"	Pg 36	35.5	42.0	31.8	16	54	51	0611.000.036	2
2"	Pg 48	51.5	60.0	47.8	20	77	74	0611.000.048	2

Die Schutzart des Schlauchanschlusses ist abhängig von der Wahl des Schlauchtyps

The protection class of the conduit fitting depends on the selection of the type of conduit





# Winkelverschraubung 90° Messing komplett

## Complete angle conduit gland 90° nickel-plated brass

### Anschlussgewinde metrisch | Entry thread metric

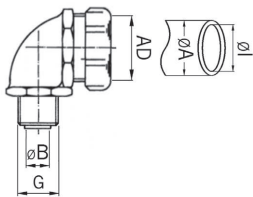

Material: Messing vernickelt  
 Dichtring: Polyamid PA 6  
 Eigenschaften: Hoher Staub- und Flüssigkeitschutz, kraftschlüssige Verbindung von Schlauch und Verschraubung, einwandfreie Erdung, Abdeckung der Schlauchenden, vibrations- und zugfest  
 Einsatzbereich: Installationen nach amerikanischen und kanadischen Installationsvorschriften, Maschinen- und Anlagenbau  
 Schutzart: IP 67  
 Einsatztemperatur: -45°C / 105°C

Material: Nickel-plated brass  
 Sealing ring: Polyamide PA 6  
 Properties: Highly watertight and dust-proof, friction locking of conduit and gland, proper earthing, covered conduit ends, resistant to stretch and vibrations  
 Application: Installation according to US and Canadian specifications, for use in machinery and installations  
 Protection class: IP 67  
 Temperature range: -45°C / 105°C



Verschraubung EW 90-M  
 zu LIQUID-TIGHT-Schutzschläuchen  
 LIQUID-TIGHT-UL / CSA / -EF

Conduit gland EW 90-M  
 for LIQUID-TIGHT protective conduits  
 LIQUID-TIGHT-UL / CSA / -EF

AD mm	G	ØI mm	ØA mm	ØB mm	C mm	U <sub>1</sub> mm	U <sub>2</sub> mm	Art.-Nr.   Art. No.	
3/8"	M16x1.5	12.5	18.0	10.2	12	26	22	0607.000.016	10
3/8"	M20x1.5	12.5	18.0	10.2	13	26	22	0607.000.020	10
1/2"	M20x1.5	16.0	21.0	13.9	13	29	27	0607.000.021	10
3/4"	M25x1.5	21.0	26.5	18.5	15	35	33	0607.000.025	5
1"	M32x1.5	26.5	33.0	23.8	15	45	42	0607.000.032	5

Die Schutzart des Schlauchanschlusses ist abhängig von der Wahl des Schlauchtyps

The protection class of the conduit fitting depends on the selection of the type of conduit

### Anschlussgewinde Pg | Entry thread Pg



Schlauchverschraubung EW 90-P  
 zu LIQUID-TIGHT-Schutzschläuchen  
 LIQUID-TIGHT-UL / CSA / -EF

Conduit gland EW 90-P  
 for LIQUID-TIGHT protective conduits  
 LIQUID-TIGHT-UL / CSA / -EF

AD mm	G	ØI mm	ØA mm	ØB mm	C mm	U <sub>1</sub> mm	U <sub>2</sub> mm	Art.-Nr.   Art. No.	
3/8"	Pg 11	12.5	18.0	10.2	12	26	22	0612.000.011	10
3/8"	Pg 13	12.5	18.0	10.2	12	26	22	0612.000.013	10
1/2"	Pg 16	16.0	21.0	13.9	13	29	27	0612.000.016	10
3/4"	Pg 21	21.0	26.5	18.5	15	35	33	0612.000.021	5
1"	Pg 29	26.5	33.0	23.8	15	45	42	0612.000.029	5
1 1/4"	Pg 36	35.5	42.0	31.8	16	54	51	0612.000.036	2
2"	Pg 48	51.5	60.0	47.8	20	77	74	0612.000.048	2

Die Schutzart des Schlauchanschlusses ist abhängig von der Wahl des Schlauchtyps

The protection class of the conduit fitting depends on the selection of the type of conduit

# Stabilisierungshülse Messing zu Schlauchverschraubungen

## Brass stabilizing bush for conduit glands

zu LIQUID-TIGHT-Schutzschläuchen | for LIQUID-TIGHT protective conduits

Material: Messing blank

Eigenschaften: Einschraubbar, ausgelegt auf die unterschiedlichen Innendurchmesser und Steigungen der verschiedenen Schutzschläuche

Einsatzbereich: Verwendung in Schlauchverschraubungen sowie als Endtülle an Schutzschläuchen

Einsatztemperatur: -40°C / +250°C

Material: Polished brass

Properties: Screw-in bush, suitable for the various inside diameters and pitches of different protective conduits

Application: Used in conduit glands and as end-cap for protective conduits

Temperature range: -40°C / +250°C

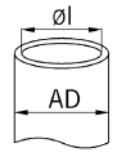
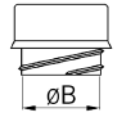

Passend zu Schlauchtypen  
LIQUID-TIGHT-UL / CSA / -EF

Suitable for conduit types  
LIQUID-TIGHT-UL / CSA / -EF

AD mm	ØI mm	ØB mm	AD mm	Art.-Nr.   Art. No.	
14	10.0	8.5	5/16"	5031.028.009	50
3/8"	12.5	11.0	-	0601.000.011	50
1/2"	16.0	14.5	-	0601.000.016	50
3/4"	21.0	19.5	27	0601.000.021	25
1"	26.5	25.0	-	0601.000.029	25



**Spezialschläuche** mit sehr hoher Flexibilität für die Sensor- und Lichtwellenleiter-Technik in der Medizin, der Optoelektronik, der Endoskopie und der Messtechnik sowie im industriellen Bereich.

Die Silikon-Ummantelung bietet eine gute elektrische Isolation, ist weitestgehend Lösungsmittel und Chemikalien beständig und bildet keine toxischen und korrosiven Brandgase.

#### **Wichtigste Eigenschaften**

- Hochflexibel
- Zugfest und querdruckbelastbar
- Luft- und flüssigkeitsdicht
- Gute Laugen- und Säurenbeständigkeit
- Halogenfrei

**Special conduits** with extremely high flexibility for sensor and optical fibre technology in medical applications, in optoelectronics, in endoscopy and measurement technology as well as for industrial use.

The silicon jacket offers high electrical insulation, is extremely resistant to solvents and chemicals, and does not release any toxic or corrosive combustion gases.

#### **Key properties**

- Extremely flexible
- Withstand high tensile stress and are crush-resistant
- Sealed against air and liquids
- High resistance to acids and alkaline substances
- Halogen-free



Optoflex Schutzschlauch flüssigkeitsdicht  
Optoflex protective conduit liquid-tight



140

1

2

3

4

5

6

7

8

**9**

10

11

12

### Optoflex PS-VA | Optoflex PS-VA

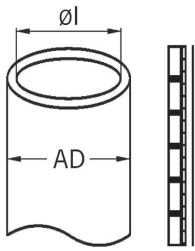

**Material:** Nichtrostender Flachstahlwendel A2 mit Glasseidenumflechtung

**Aussenmantel:** Silikon

**Eigenschaften:** Flexibel, zugfest, luft- und flüssigkeitsdicht, temperaturbeständig, schwer entflammbar und keine Bildung von toxischen und korrosiven Brandgasen, weitestgehend lösungsmittel- und chemikalienbeständig, halogen- und cadmiumfrei

**Einsatzbereich:** In der Optoelektronik, Medizintechnik, Lichtwellenleiter-Technik, technische Endoskopie, Messgeräte, Sensortechnik

**Material:** Flat steel helix made of stainless steel A2 with glass fibre sheathing

**Sheathing:** Silicone

**Properties:** Flexible, resistant to traction, air and liquid tight, temperature-resistant, flame-resistant, no formation of toxic and corrosive fire gases, widely resistant to solvents and chemicals, free from halogen and cadmium

**Application:** For optoelectronics, medical technology, waveguide technology, technical endoscopy, measuring instruments, sensor technology

**Protection class:** IP 68

**Temperature range:** -50°C / +180°C

**Schutzart:** IP 68

**Einsatztemperatur:** -50°C / +180°C



Grau				Grey	
AD mm	Øl mm	R±10% stat mm	R±10% dyn mm	Art.-Nr.   Art. No.	
4.4	2.5	14	35	0133.900.002	100
5.3	3.0	20	50	0133.900.003	100
6.5	4.0	25	65	0133.900.004	100
7.5	5.0	25	110	0133.900.005	100
10.1	7.0	45	110	0133.900.007	100

Auf Anfrage lieferbar: Available on request:  
 Weitere Abmessungen auf Anfrage Further dimensions upon request



AGROflex Geflechschläuche Kunststoff  
AGRO synthetic braided cable sleeving

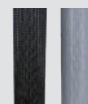

143 - 144

1

AGROflip B selbstschliessender Geflechschlauch  
AGROflip B self-closing braided sleeving



145

2

Kupfer-Hohlgeflecht auf Trägerschlauch  
Copper braiding on tube former

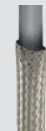

145

3

4

5

6

7

8

9

**10**

11

12



# AGROflex Geflechschläuche in Polyester und Polyamid

## AGROflex braided sleeveings made of polyester and polyamide



In Zusammenarbeit mit namhaften Kunden haben wir die Produkteigenschaften erarbeitet, welche für den Anwender besonders wichtig sind und versucht, diese Kriterien zusammen mit Produktionstechnikern in verbesserte Produkte umzusetzen.

Die bemerkenswerteste Änderung ist der spitzere Flechtwinkel, in welchem die Einzelfäden miteinander verwoben sind. Diese neue Flechtweise kombiniert mit einem etwas dünneren Monofil bei der Ausführung in Polyester führt zu einem extrem flexiblen Schlauch und zu einer hervorragenden Aufstauchbarkeit. Die Geflechte lassen sich auf das Doppelte ihrer Nennweite aufstauchen.

Der spitzere Flechtwinkel erlaubt ein geschmeidigeres Einführen von Leitungen und Kabeln auch über grössere Längen. Die Einzelfilamente laufen sozusagen parallel zu den Kabeln und stellen sich ihnen nicht als Hindernis oder „Einfädelstelle“ in den Weg.

### Wichtigste Eigenschaften

- Hochflexibel
- Aufstauchverhältnis 1:2
- Gute Laugen- und Säurenbeständigkeit
- Geprüft nach EN 45545-2

Bezüglich Zertifikate und Zulassungen von Kabelschutzschläuchen, wenden Sie sich bitte direkt an Ihren Ansprechpartner im Vertrieb.

In cooperation with renowned customers, we have defined the product properties which are especially important for the user and have tried together with production technicians to translate these criteria into improved products.

The most notable change is the more pointed braid angle in which the individual threads are interwoven. This new way of braiding, combined with a slightly thinner monofilament in the polyester version results in an extremely flexible tube and in outstanding tubefitting qualities. The meshwork can be fitted on to areas twice as large as its nominal width.

The more pointed braid angle permits smoother insertion of cords and cables even across long distances. The individual filaments run virtually parallel to the cables and do not get in their way as an obstruction or “catching area”.

### Key properties

- Extremely flexible
- Expansion ratio 1:2
- High resistance to acids and alkaline substances
- Tested according to EN 45545-2

For certificates and approvals for cable protection conduits, please contact your sales contact directly.

# AGROflex Pet Geflechschläuche Polyester

## AGROflex PET braided sleeves polyester

Material: Polyester PET  
 Monofil: Ø 0.22mm  
 Eigenschaften: Hochflexibel, selbstanpassend, abriebfest, frei von Cadmium, Formaldehyd, Halogen und Graphit, selbstverlöschend nach DIN 75200 (FMVSS 302), gute Beständigkeit gegen Kraftstoffe, Mineralöle und viele weitere Chemikalien

Aufweitung: Aufstauchverhältnis 1 : 2  
 Zulassung: EN 45545-2 (HL3)  
 Einsatztemperatur: -50°C / +150°C

Material: Polyester PET  
 Monofil: Ø 0.22mm  
 Properties: Highly flexible, self-adapting, resistant to abrasion, free of cadmium, formaldehyde, halogen and graphite, self-extinguishing acc. to DIN 75200 (FMVSS 302), good resistance to fuel, mineral oil and many other chemicals

Expansion: Expansion ratio 1 : 2  
 Approval: EN 45545-2 (HL3)  
 Temperature range: -50°C / +150°C

EN 45545-2  
HL 3

Polyester PET Schwarz matt				Polyester PET Black matt	
NW	ø min mm	ø max mm	OFB %	Art.-Nr.   Art. No.	
3	3	6	86	6875.40.03	200
4	4	8	85	6875.40.04	200
5	3	10	89	6875.40.05	200
8	6	14	81	6875.40.08	150
10	8	20	79	6875.40.10	150
15	13	25	81	6875.40.15	100
20	15	30	77	6875.40.20	100
24	24	38	82	6875.40.24	100
36	34	60	78	6875.40.36	100
50	45	80	82	6875.40.50	50

OFB = Oberflächendeckung      OFB = Percentage of the surface covered by fabric



EN 45545-2  
HL 3

Polyester PET Grau matt				Polyester PET Grey matt	
NW	ø min mm	ø max mm	OFB %	Art.-Nr.   Art. No.	
3	3	6	86	6875.70.03	200
4	4	8	85	6875.70.04	200
5	3	10	89	6875.70.05	200
8	6	14	81	6875.70.08	150
10	8	20	79	6875.70.10	150
15	13	25	81	6875.70.15	100
20	15	30	77	6875.70.20	100
24	24	38	82	6875.70.24	100
36	34	60	78	6875.70.36	100
50	45	80	82	6875.70.50	50

OFB = Oberflächendeckung      OFB = Percentage of the surface covered by fabric



### Spenderbox | Dispenser Box

EN 45545-2  
HL 3

Schwarz				Black	
NW	ø min mm	ø max mm	i info	Art.-Nr.   Art. No.	
5	3	10	12 m	6875.40.05.10	1
10	8	20	12 m	6875.40.10.10	1
18	18	27	6 m	6875.40.18.06	1
30	23	50	6 m	6875.40.30.06	1



# AGROflex PA Geflechschläuche Polyamid

## AGROflex PA braided cable sleeves polyamide

Material: Polyamid PA 6  
 Monofil: Ø 0.25mm  
 Eigenschaften: Hochflexibel, selbstanpassend, abriebfest, frei von Cadmium, Formaldehyd, Halogen und Graphit, selbstverlöschend nach DIN 75200 (FMVSS 302), gute Beständigkeit gegen Kraftstoffe, Mineralöle und viele weitere Chemikalien  
 Aufweitung: Aufstauchverhältnis 1 : 2  
 Einsatztemperatur: -40°C / +125°C

Material: Polyamide PA 6  
 Monofil: Ø 0.25mm  
 Properties: Highly flexible, self-adapting, resistant to abrasion, free of cadmium, formaldehyde, halogen and graphite, self-extinguishing acc. to DIN 75200 (FMVSS 302), good resistance to fuel, mineral oil and many other chemicals  
 Expansion: Expansion ratio 1 : 2  
 Temperature range: -40°C / +125°C



Polyamid PA 6 Schwarz				Polyamide PA 6 Black	
NW	ø min mm	ø max mm	OFB %	Art.-Nr.   Art. No.	
3	2.5	6.0	85	6850.40.03	100
4	3.0	8.5	91	6850.40.04	200
5	4.0	10.0	95	6850.40.05	100
6	4.0	9.0	85	6850.40.06	100
8	6.0	11.0	90	6850.40.08	100
10	7.0	13.5	90	6850.40.10	100
12	9.0	17.0	94	6850.40.12	100
14	10.0	22.0	85	6850.40.14	100
16	14.0	23.0	87	6850.40.16	100
18	16.0	24.0	88	6850.40.18	100
20	18.0	27.0	83	6850.40.20	100
22	18.0	32.0	84	6850.40.22	50
24	21.0	34.0	71	6850.40.24	50
25	18.0	34.0	85	6850.40.25	50
30	26.0	40.0	88	6850.40.30	50
35	28.0	40.0	88	6850.40.35	50
40	28.0	42.0	93	6850.40.40	50
45	38.0	58.0	84	6850.40.45	50
50	35.0	80.0	88	6850.40.50	50
70	55.0	80.0	91	6850.40.70	50

OFB = Oberflächendeckung  
 Grau auf Anfrage

OFB = Percentage of the surface covered by fabric  
 Colour grey on request

### AGROflip B selbstschliessender Geflechschlauch | AGROflip B self-closing braided sleeving

Material:	Polyester PET	Material:	Polyester PET
Monofil:	Ø 0.25mm	Monofil:	Ø 0.25mm
Einsatzbereich:	Problemloses Einziehen von vorkonfektionierten Kabeln, für nachträgliche Installation	Application:	Sinking of pre-connectorised cables without problems, for additional installation
Eigenschaften:	Hochflexibel, selbstanpassend, abriebfest, frei von Cadmium, Formaldehyd, Halogen und Graphit, selbstverlöschend nach DIN 75200 (FMVSS 302), gute Beständigkeit gegen Kraftstoffe, Mineralöle und viele weitere Chemikalien	Properties:	Highly flexible, self-adapting, resistant to abrasion, free of cadmium, formaldehyde, halogen and graphite, self-extinguishing acc. to DIN 75200 (FMVSS 302), good resistance to fuel, mineral oil and many other chemicals
Einsatztemperatur:	-50°C / +150°C	Temperature range:	-50°C / +150°C

AGROflip B Schwarz		AGROflip B Black		Art.-Nr.   Art. No.	
NW	ømax mm				
6	6			6878.40.06	25
9	9			6878.40.09	25
13	13			6878.40.13	25
19	19			6878.40.19	20
25	25			6878.40.25	20
32	32			6878.40.32	20
38	38			6878.40.38	20
50	50			6878.40.50	20

Nominaler Innendurchmesser mit einer Überlappung von 25% / 90°      Nominal inner diameter with 25% / 90° overlap



### Kupfer-Hohlgeflecht auf Trägerschlauch | Copper braiding on tube former

Material:	Kupferdrahtgeflecht verzinkt auf PVC-Trägerschlauch	Material:	Tinned copper round braiding on PVC tube former
Eigenschaften:	Hochflexibler Hohlgeflechtschlauch, leichtes Einziehen von Kabeln mittels Trägerschlauch	Properties:	Highly flexible hollow wire braiding conduit, easy pulling in of cables due to the tube former
Einsatzbereich:	Als EMV-Abschirm- und Entstörgeflecht	Application:	EMC-screening and shielding braiding
Einsatztemperatur:	-75°C / +150°C	Temperature range:	-75°C / +150°C

Kupfer-Hohlgeflecht auf Trägerschlauch HG-CU-K				Copper braiding on tube former HG-CU-K	
NW	ømin mm	ømax mm	kg/m	Art.-Nr.   Art. No.	
6	2.5	10.0	0.070	4051.701.008	100
10	5.0	16.0	0.093	4051.701.013	100
15	12.0	22.0	0.109	4051.701.017	100
20	16.0	27.0	0.196	4051.701.025	50
25	20.0	35.0	0.336	4051.701.040	50
35	25.0	45.0	0.370	4051.701.055	50







Dank einer Reihe kleiner Helfer bei der Kabeleinführung lassen sich Produktionsanlagen problemlos an neue Aufgaben oder Gegebenheiten anpassen. Dabei kann nicht nur die Anzahl der Leitungen abweichen, sondern es können sich auch etliche Kabeldurchmesser ändern. Um hier den Arbeitsaufwand an Gehäusen und Schaltschränken zu minimieren, empfiehlt sich der Einsatz von Erweiterungen und Reduktionen. So können zum Beispiel einzelne Adern von dicken Kabeln durch eine Erweiterung in das Gehäuse eingeführt werden, wobei die äussere Leitungsisolierung in der Kabelverschraubung endet. Hierbei bleibt die vorhandene Schutzart selbstverständlich erhalten.

Überflüssige Gehäuseöffnungen werden durch den Einsatz von Verschlusschrauben abgedichtet und somit vor dem Eindringen von Schmutz bewahrt.

Falls keine Gewindebohrung vorhanden ist, können Gegenmuttern verwendet werden.

Thanks to a range of small accessories designed for the cable entry point, production systems can be easily adapted to take account of new tasks or new situations. Not only can the number of cables themselves change but cable diameters as well. To minimise the workload on housings and switchboard the use of extension or reduction fittings is recommended. An extension, for example, can be used to introduce the individual cores of thick cable into the housing with the outer cable insulation terminating in the cable gland. It goes without saying that the existing class of protection is maintained.

Redundant housing openings are sealed by locking screws to prevent the ingress of dirt.

If there is no tapped hole, locknuts can be used.



<p>Stabilisierungshülse Messing zu Schlauchverschraubungen Brass stabilizing bush for conduit glands</p>		<p>148 - 150</p>	<p>1</p>
<p>Druckring Messing zu Schlauchverschraubungen Thrust collar brass for conduit glands</p>		<p>151</p>	<p>2</p>
<p>Dichtscheiben und O-Ringe Sealing washers and O-Rings</p>		<p>152 - 153</p>	<p>3</p>
<p>Druckausgleichs- und Entwässerungselemente Kunststoff und Messing Pressure balance element and universal swivel adapter nickel-plated brass</p>		<p>154 - 157</p>	<p>4</p>
<p>Drehadapter, Richtungsfeststeller Messing Swivel adapter, adjustable fixing devices nickel-plated brass</p>		<p>158</p>	<p>5</p>
<p>Gegenmuttern Messing Lock nuts nickel-plated brass</p>		<p>159 - 161</p>	<p>6</p>
<p>Reduktionen / Adapter und Erweiterungen Messing Reduction / adapter and enlarging fittings nickel-plated brass</p>		<p>162 - 171</p>	<p>7</p>
<p>Verschlusschrauben Messing Locking plugs nickel-plated brass</p>		<p>172 - 173</p>	<p>8</p>
<p>Gegenmuttern Kunststoff Synthetic lock nuts</p>		<p>174 - 175</p>	<p>10</p>
<p>Reduktionen / Adapter und Erweiterungen Kunststoff Synthetic reduction / adapter and enlarging fittings</p>		<p>176 - 179</p>	<p>11</p>
<p>Verschlusschrauben Kunststoff Synthetic locking plugs</p>		<p>180</p>	<p>12</p>



# Stabilisierungshülse Messing zu Schlauchverschraubungen

## Brass stabilizing bush for conduit glands

### Zubehör | Accessories

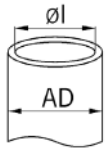
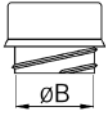

**Material:** Messing vernickelt  
**Eigenschaften:** Einschraubbar, ausgelegt auf die unterschiedlichen Innendurchmesser und Steigungen der verschiedenen Schutzschläuche  
**Einsatzbereich:** Verwendung in Schlauchverschraubungen sowie als Endtülle an Schutzschläuchen  
**Einsatztemperatur:** -40°C / +250°C

**Material:** Nickel-plated brass  
**Properties:** Screw-in bush, suitable for the various inside diameters and pitches of different protective conduits  
**Application:** Used in conduit glands and as end-cap for protective conduits  
**Temperature range:** -40°C / +250°C

Passend zu Schlauchtypen  
 SPR-AS, SPR-VA  
 FLEXAgraff®-AS

Suitable for conduit types  
 SPR-AS, SPR-VA  
 FLEXAgraff®-AS

AD mm	ØI mm	ØB mm	i info	Art.-Nr.   Art. No.	
10	8.0	6.5	-	5031.027.007	50
14	11.0	10.0	-	5031.027.009	50
14	12.0	10.5	1	5031.039.009	50
17	14.0	12.5	-	5031.027.011	50
19	16.0	14.5	-	5031.027.013	50
21	18.0	16.5	-	5031.027.016	50
27	23.0	21.5	-	5031.027.021	25
27	24.0	22.5	1	5031.039.021	25
36	31.0	29.5	-	5031.027.029	25
45	40.0	38.0	-	5031.027.036	20
56	51.0	49.0	-	5031.027.048	10

1) Nur für FLEXAgraff®-AS

1) Only for FLEXAgraff®-AS

### Zubehör | Accessories

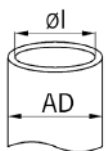
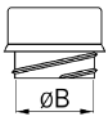

**Material:** Messing blank  
**Eigenschaften:** Einschraubbar, ausgelegt auf die unterschiedlichen Innendurchmesser und Steigungen der verschiedenen Schutzschläuche  
**Einsatzbereich:** Verwendung in Schlauchverschraubungen sowie als Endtülle an Schutzschläuchen  
**Einsatztemperatur:** -40°C / +250°C

**Material:** Polished brass  
**Properties:** Screw-in bush, suitable for the various inside diameters and pitches of different protective conduits  
**Application:** Used in conduit glands and as end-cap for protective conduits  
**Temperature range:** -40°C / +250°C

Passend zu Schlauchtypen  
 SPR-PVC-AS, SPR-PU-AS, SPR-EDU-AS  
 FLEXAgraff®-PU-AS, -CU-AS, CU-PU-AS

Suitable for conduit types  
 SPR-PVC-AS, SPR-PU-AS, SPR-EDU-AS  
 FLEXAgraff®-PU-AS, -CU-AS, CU-PU-AS

AD mm	ØI mm	ØB mm	i info	Art.-Nr.   Art. No.	
10	7.0	6.0	-	5031.028.007	50
14	10.0	8.5	-	5031.028.009	50
14	11.0	10.0	1	5031.027.009	50
17	13.0	11.5	-	5031.028.011	50
19	15.0	13.5	-	5031.028.013	50
21	17.0	15.5	-	5031.028.016	50
27	22.0	20.5	-	5031.028.021	25
27	23.0	21.5	1	5031.040.021	25
36	29.0	27.5	-	5031.028.029	25
45	38.0	36.5	-	5031.028.036	20
56	49.0	47.5	-	5031.028.048	10

1) Nur für FLEXAgraff®-PU-AS, -CU-AS, CU-PU-AS

1) Only for FLEXAgraff®-PU-AS, -CU-AS, CU-PU-AS

# Stabilisierungshülse Messing zu Schlauchverschraubungen

## Brass stabilizing bush for conduit glands

Zubehör | Accessories

Material:	Messing blank	Material:	Polished brass
Eigenschaften:	Einschraubbar, ausgelegt auf die unterschiedlichen Innendurchmesser und Steigungen der verschiedenen Schutzschläuche	Properties:	Screw-in bush, suitable for the various inside diameters and pitches of different protective conduits
Einsatzbereich:	Verwendung in Schlauchverschraubungen sowie als Endtülle an Schutzschläuchen	Application:	Used in conduit glands and as end-cap for protective conduits
Einsatztemperatur:	-40°C / +250°C	Temperature range:	-40°C / +250°C

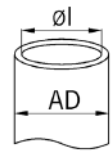
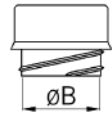

Passend zu Schlauchtypen FLEXAgraff®-SI-ASF			Suitable for conduit types FLEXAgraff®-SI-ASF	
AD mm	ØI mm	ØB mm	Art.-Nr.   Art. No.	
14	10.0	9.0	5031.037.009	50
17	12.0	10.5	5031.037.011	50
21	16.0	14.5	5031.035.016	50
27	21.0	19.5	0601.000.021	25
36	27.0	26.5	5031.037.029	25
45	36.0	34.5	5031.037.036	20
56	47.0	45.5	5031.037.048	10



Passend zu Schlauchtypen AIRflex-KUW-EDU			Suitable for conduit types AIRflex-KUW-EDU	
AD mm	ØI mm	ØB mm	Art.-Nr.   Art. No.	
14	10.0	8.5	5031.028.009	50
17	12.0	11.0	5031.035.011	50
19	14.0	12.5	5031.035.013	50
21	16.0	14.5	5031.035.016	50
27	20.0	19.5	5031.035.021	25
36	29.0	27.5	5031.028.029	25
45	37.0	35.5	5031.035.036	20
56	48.0	47.0	5031.035.048	10



Passend zu Schlauchtypen LIQUID-TIGHT-UL / CSA / -EF			Suitable for conduit types LIQUID-TIGHT-UL / CSA / -EF	
AD mm	ØI mm	ØB mm	Art.-Nr.   Art. No.	
5/16"	10.0	8.5	5031.028.009	50
3/8"	12.5	11.0	0601.000.011	50
1/2"	16.0	14.5	0601.000.016	50
3/4"	21.0	19.5	0601.000.021	25
1"	26.5	25.0	0601.000.029	25



1  
2  
3  
4  
5  
6  
7  
8  
9  
10  
11  
12

# Stabilisierungshülse Messing zu Schlauchverschraubungen

## Brass stabilizing bush for conduit glands

### Stabilisierungshülse Kunststoff zu Schlauchverschraubungen | Synthetic stabilizing bush for conduit glands

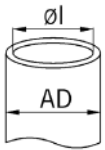
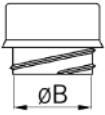

Material: Kunststoff  
 Eigenschaften: Einschraubbar, ausgelegt auf die unterschiedlichen Innendurchmesser und Steigungen der verschiedenen Schutzschläuche  
 Einsatzbereich: Verwendung in Schlauchverschraubungen sowie als Endtülle an Schutzschläuchen  
 Einsatztemperatur: -10°C / +110°C

Material: Synthetic material  
 Properties: Screw-in bush, suitable for the various inside diameters and pitches of different protective conduits  
 Application: Used in conduit glands and as end-cap for protective conduits  
 Temperature range: -10°C / +110°C

Passend zu Schlauchtypen  
 AIRflex-KUW-PU-AS / -KUW-PVC-AS / -GRS

Suitable for conduit types  
 AIRflex-KUW-PU-AS / -KUW-PVC-AS / -GRS

AD mm	ØI mm	ØB mm	Art.-Nr.   Art. No.	
10	7.0	6.0	5020.030.007	50
14	10.0	9.0	5020.030.009	50
17	13.0	11.5	5020.030.011	50
19	15.0	13.0	5020.030.013	50
21	16.0	14.5	5020.030.016	50
27	21.0	19.5	5020.030.021	25
36	29.0	26.5	5020.030.029	25
45	38.0	36.0	5020.030.036	20
56	48.0	45.5	5020.030.048	10

# Druckring Messing zu Schlauchverschraubungen

## Thrust collar brass for conduit glands

### Druckring zu Schlauchverschraubungen | Thrust collar for conduit glands

Material: Messing vernickelt  
 Einsatzbereich: Zur Erdung sowie als Potenzialausgleich bei Verwendung von Schläuchen mit Metallgeflecht im EMV-Einsatz  
 Einsatztemperatur: -40°C / +250°C

Material: Nickel-plated brass  
 Application: For grounding as well as potential equalization by use of conduits with metal braiding for shielding applications  
 Temperature range: -40°C / +250°C

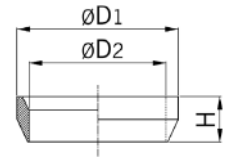

Zubehör zu Schlauchverschraubungen  
 Messing-Druckring

Conduit glands accessories  
 Thrust collar brass

AD mm	ØD1 mm	ØD2 mm	H mm	Art.-Nr.   Art. No.	
10	13	10.2	5.0	5031.034.007	50
14	17	14.5	5.0	5031.034.009	50
17	21	17.2	5.0	5031.034.011	50
19	23	19.2	6.0	5031.034.013	50
21	25	21.3	6.0	5031.034.016	50
27	32	27.3	8.5	5031.034.021	25
36	41	36.3	8.5	5031.034.029	25
45	50	45.3	8.5	5031.034.036	20
56	61	56.3	8.5	5031.034.048	10

Für EMV-Anwendungen Messingdruckring erforderlich!

For EMC applications brass thrust collar necessary!



### Dichtring Kunststoff zu Schlauchverschraubungen | Synthetic thrust collar for conduit glands

Material: PTFE (Teflon)  
 Einsatzbereich: Bei Verwendung von Schutzschläuchen mit Verschraubungen, geeignet für hohe Temperaturen  
 Einsatztemperatur: -60°C / +300°C

Material: PTFE (teflon)  
 Application: By using tubes with conduit glands suitable for high temperatures  
 Temperature range: -60°C / +300°C

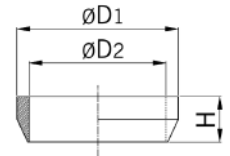

Zubehör zu Schlauchverschraubungen  
 Dichtring

Conduit glands accessories  
 Sealing ring

AD mm	ØD1 mm	ØD2 mm	H mm	Art.-Nr.   Art. No.	
10	13	10.3	6.0	5030.013.010	50
14	17	14.3	6.0	5030.013.014	50
17	21	17.3	6.0	5030.013.017	50
21	25	21.3	7.0	5030.013.021	50
27	32	27.4	9.5	5030.013.027	25
36	41	36.4	9.5	5030.013.036	25
45	50	45.4	9.5	5030.013.045	20
56	61	56.5	9.5	5030.013.056	10

Für hohe Temperaturen

For high temperature applications



# Dichtungsscheiben

## Sealing washers

### zu Anschlussgewinde metrisch | suitable for metric entry thread

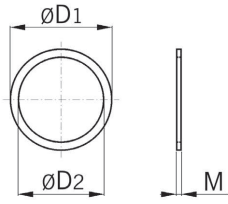

Material: Centellen  
 Farbe: Grün  
 Eigenschaften: Halogenfrei, gute Wetter-, Ozon- und Alterungsbeständigkeit, hohe mechanische Belastbarkeit  
 Einsatzbereich: Speziell zu Schnellverschraubungen zur Erreichung von Schutzart IP 68  
 Einsatztemperatur: -50°C / +200°C

Material: Centellen  
 Colour: Green  
 Properties: Halogen-free, high weather-, ozone- and ageing resistance, improved mechanical stability  
 Application: Especially in use with quick screw connectors to obtain protection class IP 68  
 Temperature range: -50°C / +200°C



zu Kunststoff Schlauchverschraubung

for synthetic conduit connector

G	ØD1 mm	ØD2 mm	M mm	Art.-Nr.   Art. No.	
M10	16.0	10.5	1.5	0333.001.010	50
M12	20.0	12.5	1.5	0333.001.012	50
M16	24.0	16.5	2.0	0333.001.016	50
M20	29.0	20.5	2.0	0333.001.020	50
M25	34.0	25.5	2.0	0333.001.025	50
M32	40.0	32.5	2.0	0333.001.032	25
M40	50.0	40.5	2.0	0333.001.040	25
M50	60.0	50.5	3.0	0333.001.050	25
M63	70.0	63.5	3.0	0333.001.063	10

### zu Anschlussgewinde Pg | suitable for entry thread Pg



zu Kunststoff Schlauchverschraubung

for synthetic conduit connector

G	ØD1 mm	ØD2 mm	M mm	Art.-Nr.   Art. No.	
Pg 7	17.0	13.0	2.0	0331.001.007	50
Pg 9	20.0	15.7	2.0	0331.001.009	50
Pg 11	24.0	19.1	2.0	0331.001.011	50
Pg 13	26.0	20.9	2.0	0331.001.013	50
Pg 16	29.0	23.0	2.0	0331.001.016	50
Pg 21	36.0	28.8	3.0	0331.001.021	25
Pg 29	48.0	37.5	3.0	0331.001.029	25
Pg 36	54.0	47.5	3.0	0331.001.036	25
Pg 48	70.0	59.8	3.0	0331.001.048	10

## O-Ring zu Schlauchverschraubungen | O-Ring for conduit glands

Material:	Perbunan	Material:	Perbunan
Einsatzbereich:	Zum Abdichten des Verschraubungsgehäuses am Anschlussgewinde	Application:	To seal the entry thread of the conduit gland
Einsatztemperatur:	-40°C / +120°C	Temperature range:	-40°C / +120°C

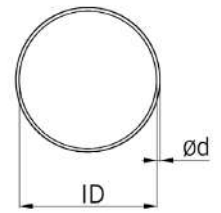

O-Ring zu Schlauchverschraubungen für metrisches Anschlussgewinde

O-Ring for conduit glands for metric entry thread

AD mm	G	ID mm	ød mm	Art.-Nr.   Art. No.	
-	M10	8	1.5	0330.001.010	50
-	M12	10	1.5	0330.001.012	50
13.0	M16	14	2.0	0330.001.016	50
-	M20	18	2.0	0330.001.020	50
21.2	M25	23	2.0	0330.001.025	50
28.5	M32	30	2.0	0330.001.032	25
34.5/42.5	M40	38	2.5	0330.001.040	25
-	M50	48	2.5	0330.001.050	25
-	M63	61	3.0	0330.001.063	10



O-Ring zu Schlauchverschraubungen für Anschlussgewinde Pg

O-Ring for conduit glands for Pg entry thread

AD mm	G	ID mm	ød mm	Art.-Nr.   Art. No.	
-	Pg 7	10	1.5	0330.000.007	50
10.0	Pg 9	13	1.5	0330.000.009	50
-	Pg 11	16	1.8	0330.000.011	50
15.8	Pg 13	18	2.0	0330.000.013	25
-	Pg 16	20	2.0	0330.000.016	50
-	Pg 21	26	2.0	0330.000.021	25
-	Pg 29	34	2.0	0330.000.029	25
-	Pg 36	44	2.5	0330.000.036	25
54.5	Pg 48	53	2.5	0330.000.048	10



## Demontagesperre für Kunststoff Verschraubungen | Dismounting lock for synthetic conduit screw connectors

Material:	Perbunan	Material:	Perbunan
Einsatztemperatur:	-40°C / +120°C	Temperature range:	-40°C / +120°C
Einsatzbereich:	Demontagesperre für Kunststoff Verschraubungen	Application:	Dismounting lock for synthetic conduit screw connectors

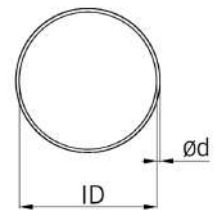

zu Kunststoff Schlauchverschraubung

for synthetic conduit connector

AD mm	ID mm	ød mm	Art.-Nr.   Art. No.	
10.0	13	1.5	0330.000.009	50
13.0	14	2.0	0330.001.016	50
15.8	18	2.0	0330.000.013	25
21.2	23	2.0	0330.001.025	50
28.5	30	2.0	0330.001.032	25
34.5/42.5	38	2.5	0330.001.040	25
54.5	53	2.5	0330.000.048	10





# Druckausgleichselement Messing und Kunststoff

## Pressure balance element nickel-plated brass and synthetic

### Anschlussgewinde metrisch | Entry thread metric

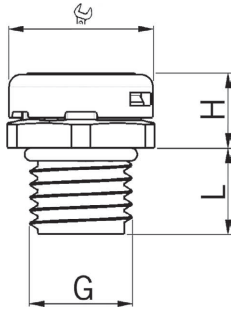

Material: Polyamid PA 6  
 Membrane: PES Polyethersulfon  
 O-Ring: NBR  
 Einsatztemperatur: -40°C / +100°C  
 Schutzart: IP 66 / IP 68 / IP69K  
 Wassereintrittsdruck: > 12.0 psi / 0.83 bar

Luftdurchsatz: > 90ml / min / cm<sup>2</sup> bei 10mbar  
 Eigenschaften: halogenfrei, UV beständig (getestet nach EN ISO 4892-2)



Material: Polyamide PA 6  
 Membrane: PES polyethersulfone  
 O-ring: NBR  
 Temperature range: -40°C / +100°C  
 Protection class: IP 66 / IP 68 / IP69K  
 Water intrusion pressure: > 12.0 psi / 0.83 bar

Air flow rate: > 90ml / min / cm<sup>2</sup> at 10mbar  
 Properties: halogen-free, UV resistant (tested according to EN ISO 4892-2)



mit Membrane  
 Schwarz

with membrane  
 Black

G	 mm	H mm	L mm	Art.-Nr.   Art. No.	
M12x1.5	17	9	10	2445.12	25

### Anschlussgewinde metrisch | Entry thread metric

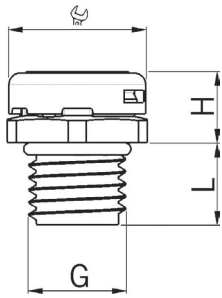

Material: Polyamid PA 6  
 Membrane: PES Polyethersulfon  
 O-Ring: NBR  
 Einsatztemperatur: -40°C / +100°C  
 Schutzart: IP 66 / IP 68 / IP 69K  
 Wassereintrittsdruck: > 12.0 psi / 0.83 bar

Luftdurchsatz: > 90ml / min / cm<sup>2</sup> bei 10mbar  
 Eigenschaften: halogenfrei

Material: Polyamide PA 6  
 Membrane: PES polyethersulfone  
 O-ring: NBR  
 Temperature range: -40°C / +100°C  
 Protection class: IP 66 / IP 68 / IP 69K  
 Water intrusion pressure: > 12.0 psi / 0.83 bar

Air flow rate: > 90ml / min / cm<sup>2</sup> at 10mbar  
 Properties: halogen-free



mit Membrane  
 Hellgrau RAL 7035

with membrane  
 Light grey RAL 7035

G	 mm	H mm	L mm	Art.-Nr.   Art. No.	
M12x1.5	17	9	10	2455.12	25

# Druckausgleichselement Messing und Kunststoff

## Pressure balance element nickel-plated brass and synthetic

### Druckausgleichselement mit Membrane erhöhte Sicherheit Ex e II

#### Pressure balance element with membrane increased safety Ex e II

Material: Messing vernickelt  
 Membrane: PES Polyethersulfon  
 O-Ring: FPM  
 Einsatztemperatur: -60°C / +100°C  
 Schutzart: IP 66 / IP 68 / IP69K  
 Prüfnorm: IEC EN 60079-0  
 IEC EN 60079-7  
 IEC EN 60079-31  
 Gas: II 2G Ex eb IIC Gb  
 Staub: II 2D Ex tb IIIC Db  
 Zone: Gas 1 und 2  
 Staub 21 und 22  
 Zertifikat: SEV 16 ATEX 0143  
 IECEx Zertifikat: IECEx SEV 16.0010

Material: Nickel-plated brass  
 Membrane: PES polyethersulfone  
 O-ring: FPM  
 Temperature range: -60°C / +100°C  
 Protection class: IP 66 / IP 68 / IP69K  
 Test standard: IEC EN 60079-0  
 IEC EN 60079-7  
 IEC EN 60079-31  
 Gas: II 2G Ex eb IIC Gb  
 Dust: II 2D Ex tb IIIC Db  
 Zone: Gas 1 and 2  
 Dust 21 and 22  
 Certificate: SEV 16 ATEX 0143  
 IECEx Certificate: IECEx SEV 16.0010

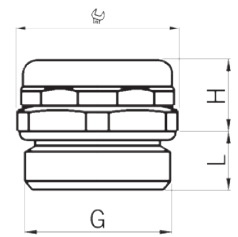

#### EX DAE



mit Membrane mit O-Ring				with membrane with O-ring	
G	$\varnothing$ mm	H mm	L mm	Art.-Nr.   Art. No.	
M12x1.5	18	9.5	8	EX2450.12.34	25
M16x1.5	18	9.5	8	EX2450.17.34	20
M20x1.5	22	10.0	8	EX2450.20.34	20

Auf Anfrage lieferbar: Rostfreier Stahl A2 oder A4  
 Anschlussgewinde Pg

Available on request:  
 Stainless steel A2 or A4  
 Entry thread Pg



# Druckausgleichselement Messing und Kunststoff

## Pressure balance element nickel-plated brass and synthetic

### Anschlussgewinde metrisch | Entry thread metric

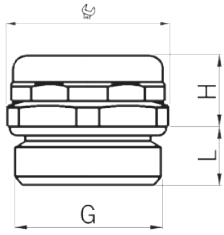

Material: Messing vernickelt  
 Membrane: PES Polyethersulfon  
 O-Ring: NBR  
 Einsatztemperatur: -40°C / +110°C  
 Schutzart: IP 66 / IP 68 / IP 69K  
 Wassereintrittsdruck: > 12.0 psi / 0.83 bar



Material: Nickel-plated brass  
 Membrane: PES polyethersulfone  
 O-ring: NBR  
 Temperature range: -40°C / +110°C  
 Protection class: IP 66 / IP 68 / IP 69K  
 Water intrusion pressure: > 12.0 psi / 0.83 bar  
 Air flow rate: > 90ml / min / cm<sup>2</sup> at 10mbar

Luftdurchsatz: > 90ml / min / cm<sup>2</sup> bei 10mbar



mit Membrane  
mit O-Ring

with membrane  
with O-ring

G	 mm	H mm	L mm	Art.-Nr.   Art. No.	
M12x1.5	18	9.5	8	2450.12.34	25
M16x1.5	18	9.5	8	2450.17.34	20
M20x1.5	22	10.0	8	2450.20.34	20

Auf Anfrage lieferbar:  
 Rostfreier Stahl A2 oder A4  
 Für hohe Temperaturen (+200°C)



Available on request:  
 Stainless steel A2 or A4  
 For high temperature applications (+200°C)

### Anschlussgewinde Pg | Entry thread Pg



mit Membrane  
mit O-Ring

with membrane  
with O-ring

G	 mm	H mm	L mm	Art.-Nr.   Art. No.	
Pg 7	18	9.5	8	2450.07.34	25
Pg 11	22	10.0	8	2450.11.34	20

Auf Anfrage lieferbar:  
 Rostfreier Stahl A2 oder A4  
 Für hohe Temperaturen (+200°C)

Available on request:  
 Stainless steel A2 or A4  
 For high temperature applications (+200°C)

### Anschlussgewinde metrisch | Entry thread metric

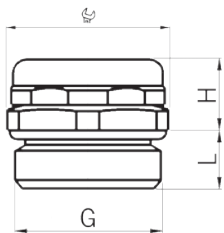

Material: Messing vernickelt  
 Filterscheibe: Sinterbronze  
 O-Ring: NBR  
 Einsatztemperatur: -50°C / +110°C  
 Schutzart: IP 54 / IP x9K  
 Filtergrad: 40 µm

Material: Nickel-plated brass  
 Filter disc: Sintered bronze  
 O-ring: NBR  
 Temperature range: -50°C / +110°C  
 Protection class: IP 54 / IP x9K  
 Degree of filter: 40 µm



mit Sinterfilter  
mit O-Ring

Sintered filter  
with O-ring

G	 mm	H mm	L mm	Art.-Nr.   Art. No.	
M12x1.5	18	9.5	8	2450.12.32	25
M16x1.5	18	9.5	8	2450.17.32	20
M20x1.5	22	10.0	8	2450.20.32	20

Auf Anfrage lieferbar:  
 Rostfreier Stahl A2 oder A4  
 Für hohe Temperaturen (+200°C)

Available on request:  
 Stainless steel A2 or A4  
 For high temperature applications (+200°C)

# Druckausgleichselement Messing und Kunststoff

## Pressure balance element nickel-plated brass and synthetic

### Anschlussgewinde Pg | Entry thread Pg

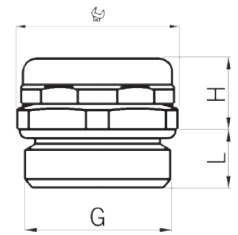

Material: Messing vernickelt  
 Filterscheibe: Sinterbronze  
 O-Ring: NBR  
 Einsatztemperatur: -50°C / +110°C  
 Schutzart: IP 54 / IP x9K  
 Filtergrad: 40 µm

Material: Nickel-plated brass  
 Filter disc: Sintered bronze  
 O-ring: NBR  
 Temperature range: -50°C / +110°C  
 Protection class: IP 54 / IP x9K  
 Degree of filter: 40 µm



mit Sinterfilter  
 mit O-Ring

Sintered filter  
 with O-ring

G	 mm	H mm	L mm	Art.-Nr.   Art. No.	
Pg 7	18	9.5	8	2450.07.32	25
Pg 11	22	10.0	8	2450.11.32	20

Auf Anfrage lieferbar:  
 Rostfreier Stahl A2 oder A4  
 Für hohe Temperaturen (+200°C)

Available on request:  
 Stainless steel A2 or A4  
 For high temperature applications (+200°C)



### Anschlussgewinde metrisch | Entry thread metric

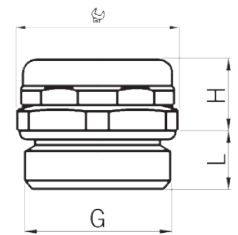

Material: Messing vernickelt  
 Sieb: Rostfreier Stahl A2  
 O-Ring: NBR  
 Einsatztemperatur: -50°C / +110°C  
 Schutzart: IP 4x

Material: Nickel-plated brass  
 Mesh: Stainless steel A2  
 O-ring: NBR  
 Temperature range: -50°C / +110°C  
 Protection class: IP 4x



mit Sieb  
 mit O-Ring

with mesh  
 with O-ring

G	 mm	H mm	L mm	Art.-Nr.   Art. No.	
M12x1.5	18	9.5	10	2450.12.36	25
M16x1.5	18	9.5	10	2450.17.36	20
M20x1.5	22	10.0	10	2450.20.36	20

Auf Anfrage lieferbar:  
 Rostfreier Stahl A2 oder A4

Available on request:  
 Stainless steel A2 or A4



### Anschlussgewinde metrisch | Entry thread metric

Material: Messing vernickelt  
 Einsatztemperatur: -50°C / +200°C

Material: Nickel-plated brass  
 Temperature range: -50°C / +200°C

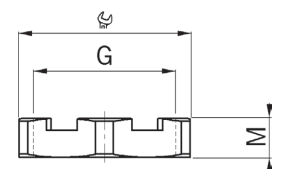

zum Entwässerungselement

for drainage element

G	 mm	M mm	Art.-Nr.   Art. No.	
M12x1.5	15	4.5	8324.12	25
M16x1.5	19	5.5	8324.17	20
M20x1.5	24	5.5	8324.20	20



# Drehadapter und Richtungsfeststeller Messing

## Swivel adapter and adjustable fixing devices nickel-plated brass

### Kurzes Anschlussgewinde metrisch | Short entry thread metric

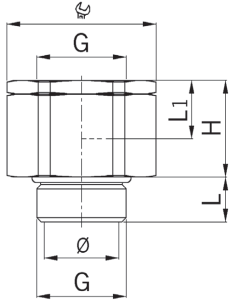

Material: Messing vernickelt  
 Dichtringe: NBR  
 Einsatztemperatur: -40°C / +100°C  
 Schutzart: IP 68  
 Eigenschaften: Universell verwendbar mit Kabel- oder Schlauchverschraubungen, gute Drehfreudigkeit durch spezielle Lagerung

Material: Nickel-plated brass  
 Sealing rings: NBR  
 Temperature range: -40°C / +100°C  
 Protection class: IP 68  
 Properties: Multifunctional use in combination with cable- or conduit glands, smooth rotation due to a special bearing



G	$\frac{G}{mm}$	H mm	L mm	L1 mm	Ø mm	Art.-Nr.   Art. No.	
M16x1.5	24	20	10	12	11.0	2410.17	25
M20x1.5	30	22	10	13	15.5	2410.20	25
M25x1.5	36	24	11	13	20.5	2410.25	25
M32x1.5	46	27	13	14	28.0	2410.32	10
M40x1.5	55	28	13	15	37.0	2410.40	10
M50x1.5	65	32	14	16.5	43.0	2410.50	5

Achtung! Der Universal-Drehadapter kann kein Kugel- oder Wälzlager ersetzen! Attention! The swivel adapter can not replace rolling- or ball bearings!

### Anschlussgewinde metrisch | Entry thread metric

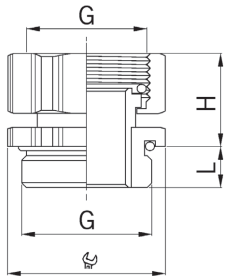

Material: Messing vernickelt  
 O-Ring: 2 x NBR  
 Einsatztemperatur: -30°C / +100°C  
 Schutzart: IP 68  
 Einsatzbereich: Besonders geeignet für die richtungsstabile Montage von Winkeln

Material: Nickel-plated brass  
 O-ring: 2 x NBR  
 Temperature range: -30°C / +100°C  
 Protection class: IP 68  
 Application: Suitable for directionally stable mounting of elbows



G	$\frac{G}{mm}$	H mm	L mm	Art.-Nr.   Art. No.	
M16x1.5	18	14	6	5000.17.50	50
M20x1.5	22	14	6	5000.20.50	50
M25x1.5	28	15	7	5000.25.50	50
M32x1.5	35	18	8	5000.32.50	50

# Gegenmuttern Messing



## Lock nuts nickel-plated brass

### Anschlussgewinde metrisch | Entry thread metric

Material: Messing vernickelt  
 Ausführung: 6-kant  
 Einsatztemperatur: -40°C / +200°C

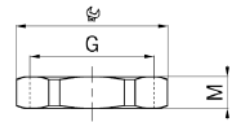
Material: Nickel-plated brass  
 Execution: Hexagonal design  
 Temperature range: -40°C / +200°C





Gewinde metrisch				Metric thread		
G	 mm	M	i	Art.-Nr.   Art. No.		
M6x0.75	9	2.8	-	8000.06.1	50	
M6x1.0	9	2.8	1	8000.06	50	
M8x1.0	11	2.8	-	8000.08.1	50	
M8x1.25	11	2.8	1	8000.08	50	
M10x1.0	13	2.8	-	8000.10.1	50	
M10x1.5	13	2.8	1	8000.10	50	
M12x1.5	15	3.0	-	8000.12	100	
M16x1.5	19	3.0	-	8000.17	100	
M20x1.5	24	3.5	-	8000.20	100	
M25x1.5	30	4.0	-	8000.25	50	
M32x1.5	36	4.0	-	8000.32	25	
M40x1.5	46	5.0	-	8000.40	25	
M50x1.5	55	5.5	-	8000.50	10	
M63x1.5	70	6.0	-	8000.63	10	
M75x1.5	80	6.0	-	8000.75	10	
M80x2.0	95	8.0	-	8000.080	5	
M85x2.0	95	8.0	-	8000.085	5	
M95x2.0	110	9.0	-	8000.095	5	
M100x3.0	115	9.0	-	8000.100	1	
M105x3.0	120	9.0	-	8000.105	1	
M115x3.0	125	10.0	-	8000.115	1	

1 = Metrisches Regelgewinde      1 = Metric coarse-pitch thread



### Anschlussgewinde Pg | Entry thread Pg

Gewinde Pg			Pg thread		
G	 mm	M	Art.-Nr.   Art. No.		
Pg 7	15	3.0	8007	50	
Pg 9	18	3.0	8009	50	
Pg 11	21	3.0	8011	50	
Pg 13	23	3.0	8013	50	
Pg 16	26	3.0	8016	50	
Pg 21	32	3.5	8021	25	
Pg 29	41	4.0	8029	10	
Pg 36	51	5.0	8036	10	
Pg 42	60	5.0	8042	10	
Pg 48	64	5.5	8048.48	400	





# Gegenmuttern Messing

## Lock nuts nickel-plated brass

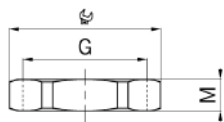

### Anschlussgewinde Gasrohr | Gas-pipe entry thread



Material: Messing vernickelt  
 Ausführung: 6-kant  
 Einsatztemperatur: -40°C / +200°C

Material: Nickel-plated brass  
 Execution: Hexagonal design  
 Temperature range: -40°C / +200°C





Gasrohr-Gewinde				Gas-pipe thread		
G	 mm	M mm	i info	Art.-Nr.   Art. No.		
G 3/8"	19	3.0	-	803/8G	10	
G 1/2"	24	3.0	-	801/2G	10	
G 5/8"	26	3.0	-	805/8G	10	
G 3/4"	30	3.5	-	803/4G	10	
G 1"	38	4.5	-	801G	10	
G 1 1/2"	51	5.0	-	8011/2G	10	
G 1 1/4"	46	5.0	-	8011/4G	10	
G 2"	64	5.5	-	8048	5	
G 2 1/2"	90	12.0	1	8050	5	
G 3"	105	12.0	1	8051	5	

1 = Runde Bauform, Stahl verzinkt      1 = Round form, zinc coated steel



### Anschlussgewinde metrisch | Entry thread metric



Dicke Ausführung			Thick-walled version		
G	 mm	M mm	Art.-Nr.   Art. No.		
M12x1.5	15	5.0	8300.12	50	
M16x1.5	19	5.0	8300.17	50	
M20x1.5	24	5.5	8300.20	50	
M25x1.5	30	5.5	8300.25	50	
M32x1.5	36	6.0	8300.32	50	
M40x1.5	46	7.0	8300.40	50	

### Anschlussgewinde Pg | Entry thread Pg



Dicke Ausführung			Thick-walled version		
G	 mm	M mm	Art.-Nr.   Art. No.		
Pg 7	15	5.0	8300.07	50	
Pg 9	18	5.0	8300.09	50	
Pg 11	21	5.0	8300.11	50	
Pg 13	24	5.5	8300.13	50	
Pg 16	26	5.5	8300.16	50	
Pg 21	32	6.0	8300.21	50	
Pg 29	41	7.0	8300.29	50	

# Gegenmuttern Messing



## Lock nuts nickel-plated brass

Anschlussgewinde metrisch | Entry thread metric

Material: Messing vernickelt  
 Ausführung: 6-kant  
 O-Ring: Separat bestellen  
 Einsatztemperatur: -40°C / +200°C

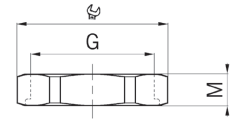
Material: Nickel-plated brass  
 Execution: Hexagonal design  
 O-ring: To be ordered separately  
 Temperature range: -40°C / +200°C



Dicke Ausführung ohne O-Ring				Thick-walled version without O-Ring		
G	 mm	M mm	O-ring	Art.-Nr.   Art. No.		
M12x1.5	15	5.0	1007.00.08	8300.12.1	50	
M16x1.5	19	5.0	1016.00.15.08	8300.17.1	50	
M20x1.5	24	5.5	1016.00.08	8300.20.1	50	
M25x1.5	30	5.5	1013.00.22.08	8300.25.1	50	
M32x1.5	36	6.0	1021.00.30.08	8300.32.1	50	
M40x1.5	46	7.0	1029.00.39.08	8300.40.1	50	
M50x1.5	55	7.5	1036.00.49.08	8300.50.1	10	
M63x1.5	70	8.0	1048.00.62.08	8300.63.1	10	



1  
2  
3  
4  
5  
6  
7  
8  
9  
10  
11  
12

# Reduktionen Messing

## Reduction fittings nickel-plated brass

mit 6-kant | hexagonal

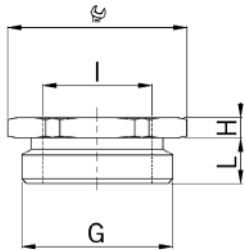

Material: Messing vernickelt  
 O-Ring: NBR  
 Einsatztemperatur: -40°C / +100°C  
 Schutzart: IP 68

Material: Nickel-plated brass  
 O-ring: NBR  
 Temperature range: -40°C / +100°C  
 Protection class: IP 68



Aussengewinde metrisch  
 Innengewinde metrisch  
 mit O-Ring

Outer thread metric  
 Inner thread metric  
 with O-ring

G	I	$\frac{G}{H}$ mm	H mm	L mm	i info	Art.-Nr.   Art. No.	
M 8x1.25	M 6x1.0	11	8.0	5	1	3500.08.06	50
M10x1.5	M 6x1.0	13	3.0	5	1	3500.10.06	50
M10x1.5	M 8x1.25	13	8.0	5	1	3500.10.08	50
M12x1.5	M 8x1.25	15	3.0	5	1	3500.12.08	50
M12x1.5	M10x1.5	15	8.0	5	1	3500.12.10	50
M16x1.5	M10x1.5	18	3.0	5	1	3500.17.10	50
M16x1.5	M12x1.5	18	3.0	5	-	3500.17.12	50
M20x1.5	M12x1.5	24	3.0	6	-	3500.20.12	50
M20x1.5	M16x1.5	24	3.0	6	-	3500.20.17	50
M25x1.5	M16x1.5	30	3.5	7	-	3500.25.17	25
M25x1.5	M20x1.5	30	3.5	7	-	3500.25.20	25
M32x1.5	M20x1.5	36	4.0	8	-	3500.32.20	20
M32x1.5	M25x1.5	36	4.0	8	-	3500.32.25	20
M40x1.5	M25x1.5	46	4.5	8	-	3500.40.25	10
M40x1.5	M32x1.5	46	4.5	8	-	3500.40.32	10
M50x1.5	M32x1.5	55	5.0	9	-	3500.50.32	10
M50x1.5	M40x1.5	55	5.0	9	-	3500.50.40	10
M63x1.5	M40x1.5	70	5.5	10	-	3500.63.40	5
M63x1.5	M50x1.5	70	5.5	10	-	3500.63.50	5
M75x1.5	M50x1.5	80	6.0	11	-	3500.75.50	5
M75x1.5	M63x1.5	80	6.0	11	-	3500.75.63	5

1 = Metrisches Regelgewinde

1 = Metric coarse-pitch thread

# Reduktionen Messing

## Reduction fittings nickel-plated brass

### Runde Bauform, randriert | Round, knurled

Material: Messing vernickelt  
 Einsatztemperatur: -40°C / +200°C  
 Schutzart: IP 54  
 Weitere Schutzart: IP 68, wenn Anschlussgewinde abgedichtet

Material: Nickel-plated brass  
 Temperature range: -40°C / +200°C  
 Protection class: IP 54  
 Further protection: IP 68, if the entry thread is sealed

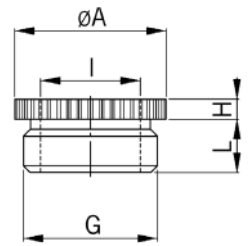

Aussengewinde metrisch Innengewinde metrisch ohne O-Ring					Outer thread metric Inner thread metric without O-Ring	
G	I	øA mm	H mm	L mm	Art.-Nr.   Art. No.	
M16x1.5	M12x1.5	18	3	7	3545.17.12	100
M20x1.5	M12x1.5	22	3	8	3545.20.12	100
M20x1.5	M16x1.5	22	3	8	3545.20.17	100
M25x1.5	M16x1.5	27	3	8	3545.25.17	50
M25x1.5	M20x1.5	27	3	8	3545.25.20	50
M32x1.5	M20x1.5	34	4	9	3545.32.20	50
M32x1.5	M25x1.5	34	4	9	3545.32.25	50
M40x1.5	M25x1.5	42	4.5	9	3545.40.25	50
M40x1.5	M32x1.5	42	4.5	9	3545.40.32	25
M50x1.5	M32x1.5	52	4.5	10	3545.50.32	25
M50x1.5	M40x1.5	52	4.5	10	3545.50.40	10
M63x1.5	M40x1.5	65	5	11	3545.63.40	10
M63x1.5	M50x1.5	65	5	11	3545.63.50	10

### mit 6-kant | hexagonal

Material: Messing vernickelt  
 O-Ring: NBR  
 Einsatztemperatur: -40°C / +100°C  
 Schutzart: IP 68

Material: Nickel-plated brass  
 O-ring: NBR  
 Temperature range: -40°C / +100°C  
 Protection class: IP 68

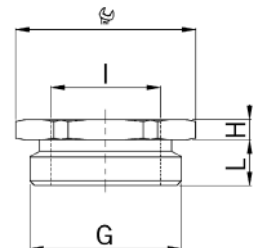

Aussengewinde Pg Innengewinde Pg mit O-Ring					Outer thread Pg Inner thread Pg with O-ring	
G	I	 mm	H mm	L mm	Art.-Nr.   Art. No.	
Pg 9	Pg 7	18	3.0	6.5	3509.07	50
Pg 11	Pg 7	20	3.0	6.5	3511.07	50
Pg 11	Pg 9	22	3.0	7.0	3511.09	50
Pg 13	Pg 7	24	3.0	7.0	3513.07	50
Pg 13	Pg 9	24	3.0	7.0	3513.09	50
Pg 13	Pg 11	24	3.0	7.0	3513.11	50
Pg 16	Pg 9	24	3.0	7.0	3516.09	50
Pg 16	Pg 11	24	3.0	7.0	3516.11	50
Pg 16	Pg 13	27	3.0	7.0	3516.13	50
Pg 21	Pg 11	32	3.5	7.5	3521.11	25
Pg 21	Pg 13	32	3.5	7.5	3521.13	25
Pg 21	Pg 16	32	3.5	7.5	3521.16	25
Pg 29	Pg 13	38	4.0	8.0	3529.13	10
Pg 29	Pg 16	38	4.0	8.0	3529.16	10
Pg 29	Pg 21	38	4.0	8.0	3529.21	10
Pg 36	Pg 21	50	4.5	8.5	3536.21	10
Pg 36	Pg 29	50	4.5	8.5	3536.29	10
Pg 42	Pg 29	60	4.0	11.0	3542.29	10
Pg 42	Pg 36	60	4.0	11.0	3542.36	10
Pg 48	Pg 36	65	4.0	11.0	3548.48.36	10

# Erweiterungen Messing

## Reduction fittings nickel-plated brass

### mit 6-kant | hexagonal

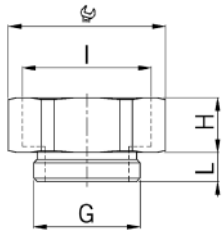



Material: Messing vernickelt  
 O-Ring: NBR  
 Einsatztemperatur: -40°C / +100°C  
 Schutzart: IP 68

Material: Nickel-plated brass  
 O-ring: NBR  
 Temperature range: -40°C / +100°C  
 Protection class: IP 68



Aussengewinde metrisch  
 Innengewinde metrisch  
 mit O-Ring

Outer thread metric  
 Inner thread metric  
 with O-ring

G	I	 mm	H mm	L mm	i info	Art.-Nr.   Art. No.	
M 6x1.0	M 8x1.25	11	8.5	5	1	3600.06.08	50
M 6x1.0	M10x1.5	13	8.5	5	1	3600.06.10	50
M 8x1.25	M10x1.5	13	9	5	1	3600.08.10	50
M 8x1.25	M12x1.5	15	9	5	1	3600.08.12	50
M10x1.5	M12x1.5	15	9	5	1	3600.10.12	50
M10x1.5	M16x1.5	18	9	5	1	3600.10.17	50
M12x1.5	M16x1.5	18	9	5	-	3600.12.17	50
M12x1.5	M20x1.5	24	10	5	-	3600.12.20	50
M16x1.5	M20x1.5	24	10	5	-	3600.17.20	50
M20x1.5	M25x1.5	30	11.5	6	-	3600.20.25	25
M25x1.5	M32x1.5	36	14	7	-	3600.25.32	25
M32x1.5	M40x1.5	46	14	8	-	3600.32.40	25
M40x1.5	M50x1.5	55	16	8	-	3600.40.50	10
M50x1.5	M63x1.5	70	17	9	-	3600.50.63	10
M63x1.5	M75x1.5	80	18	10	-	3600.63.75	10

1 = Metrisches Regelgewinde

1 = Metric coarse-pitch thread

### Runde Bauform | Round execution

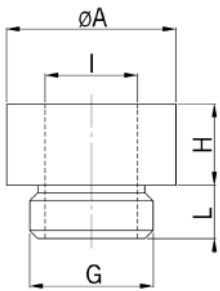

Material: Messing vernickelt  
 Einsatztemperatur: -40°C / +200°C  
 Schutzart: IP 54  
 Weitere Schutzart: IP 68, wenn Anschlussgewinde abgedichtet

Material: Nickel-plated brass  
 Temperature range: -40°C / +200°C  
 Protection class: IP 54  
 Further protection: IP 68, if the entry thread is sealed



Aussengewinde metrisch  
 Innengewinde metrisch  
 ohne O-Ring

Outer thread metric  
 Inner thread metric  
 without O-Ring

G	I	ØA mm	H mm	L mm	Art.-Nr.   Art. No.	
M12x1.5	M16x1.5	19	9.5	6.5	3645.12.17	100
M16x1.5	M20x1.5	22	10.5	7	3645.17.20	100
M20x1.5	M25x1.5	27	11	8	3645.20.25	100
M25x1.5	M32x1.5	34	12	8	3645.25.32	50
M32x1.5	M40x1.5	42	12	9	3645.32.40	50
M40x1.5	M50x1.5	53	14	9	3645.40.50	25
M50x1.5	M63x1.5	66	19	10	3645.50.63	25

# Reduktionen und Erweiterungen Messing Enlarging fittings nickel-plated brass

mit 6-kant | hexagonal

Material: Messing vernickelt  
O-Ring: NBR  
Einsatztemperatur: -40°C / +100°C  
Schutzart: IP 68

Material: Nickel-plated brass  
O-ring: NBR  
Temperature range: -40°C / +100°C  
Protection class: IP 68

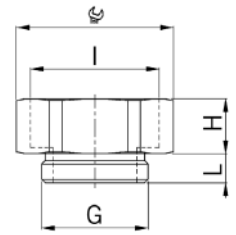

Aussengewinde Pg Innengewinde Pg mit O-Ring					Outer thread Pg Inner thread Pg with O-ring		Art.-Nr.   Art. No.		
G	I	 mm	H mm	L mm					
<b>Pg 7</b>	Pg 9	18	13	8			<b>3607.09.08</b>	50	
<b>Pg 9</b>	Pg 11	22	15	8			<b>3609.11.08</b>	50	
<b>Pg 9</b>	Pg 13	24	15	8			<b>3609.13.08</b>	50	
<b>Pg 11</b>	Pg 13	24	15	8			<b>3611.13.08</b>	50	
<b>Pg 11</b>	Pg 16	24	15	8			<b>3611.16.08</b>	50	
<b>Pg 11</b>	Pg 21	32	16	8			<b>3611.21.08</b>	50	
<b>Pg 13</b>	Pg 16	24	15	8			<b>3613.16.08</b>	50	
<b>Pg 13</b>	Pg 21	32	16	8			<b>3613.21.08</b>	50	
<b>Pg 16</b>	Pg 21	32	16	8			<b>3616.21.08</b>	25	
<b>Pg 16</b>	Pg 29	40	16	8			<b>3616.29.08</b>	25	
<b>Pg 21</b>	Pg 29	40	16	8			<b>3621.29.08</b>	25	
<b>Pg 29</b>	Pg 36	50	18	10			<b>3629.36.08</b>	20	
<b>Pg 36</b>	Pg 42	60	19	12			<b>3636.42.08</b>	10	
<b>Pg 36</b>	Pg 48	64	20	12			<b>3636.48.48.08</b>	10	



1  
2  
3  
4  
5  
6  
7  
8  
9  
10  
11  
12



# Adapter Messing

## Adapter nickel-plated brass

mit 6-kant | hexagonal

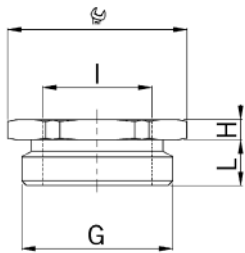



Material: Messing vernickelt  
 O-Ring: NBR  
 Einsatztemperatur: -40°C / +100°C  
 Schutzart: IP 68

Material: Nickel-plated brass  
 O-ring: NBR  
 Temperature range: -40°C / +100°C  
 Protection class: IP 68



Aussengewinde metrisch  
 Innengewinde Pg  
 mit O-Ring



Outer thread metric  
 Inner thread Pg  
 with O-ring

G	I	 mm	H mm	L mm	Art.-Nr.   Art. No.	
M16x1.5	Pg 7	20	3.0	7	3500.17.07	50
M20x1.5	Pg 7	24	3.0	7	3500.20.07	50
M20x1.5	Pg 9	24	3.0	7	3500.20.09	50
M20x1.5	Pg 11	24	10.0	7	3500.20.11	50
M25x1.5	Pg 9	30	3.5	8	3500.25.09	50
M25x1.5	Pg 11	30	3.5	8	3500.25.11	50
M25x1.5	Pg 13	30	3.8	8	3500.25.13	50
M25x1.5	Pg 16	30	15.0	8	3500.25.16	25
M32x1.5	Pg 21	38	16.0	8	3500.32.21	25
M40x1.5	Pg 29	45	16.0	8	3500.40.29	10
M50x1.5	Pg 29	55	4.0	10	3500.50.29	10
M63x1.5	Pg 36	70	5.5	11	3500.63.36	10



Aussengewinde metrisch  
 Innengewinde Pg  
 mit O-Ring

Outer thread metric  
 Inner thread Pg  
 with O-ring

G	I	 mm	H mm	L mm	i info	Art.-Nr.   Art. No.	
M10x1.5	Pg 7	16	12	6	1	3600.10.07	50
M10x1.5	Pg 9	18	12	6	1	3600.10.09	50
M12x1.5	Pg 9	18	12	7	-	3600.12.09	50
M16x1.5	Pg 11	22	14	7	-	3600.17.11	50
M20x1.5	Pg 13	24	15	7	-	3600.20.13	50
M20x1.5	Pg 16	24	15	7	-	3600.20.16	50
M25x1.5	Pg 21	32	16	8	-	3600.25.21	25
M32x1.5	Pg 29	40	16	8	-	3600.32.29	25
M40x1.5	Pg 36	50	18	8	-	3600.40.36	20
M50x1.5	Pg 42	60	19	10	-	3600.50.42	10
M50x1.5	Pg 48	64	20	10	-	3600.50.48	10

1 = Metrisches Regelgewinde

1 = Metric coarse-pitch thread

### mit 6-kant | hexagonal

Material: Messing vernickelt  
 O-Ring: NBR  
 Einsatztemperatur: -40°C / +100°C  
 Schutzart: IP 68

Material: Nickel-plated brass  
 O-ring: NBR  
 Temperature range: -40°C / +100°C  
 Protection class: IP 68

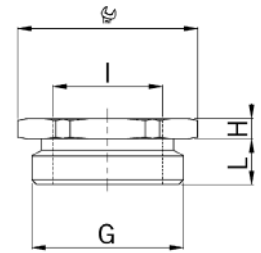

Aussengewinde Pg		Outer thread Pg					Art.-Nr.   Art. No.	
Innengewinde metrisch mit O-Ring		Inner thread metric with O-ring						
G	I	mm	H mm	L mm	i info			
Pg 7	M 6x1.0	15	3.0	6	1	3500.07.06	50	
Pg 7	M 8x1.25	15	3.0	6	1	3500.07.08	50	
Pg 7	M10x1.5	15	7.0	6	1	3500.07.10	50	
Pg 9	M 6x1.0	18	3.0	6	1	3500.09.06	50	
Pg 9	M 8x1.25	18	3.0	6	1	3500.09.08	50	
Pg 9	M10x1.5	18	3.0	6	1	3500.09.10	50	
Pg 9	M12x1.5	18	8.0	6	-	3500.09.12	50	
Pg 11	M 6x1.0	21	3.0	6	1	3500.11.06	50	
Pg 11	M 8x1.25	21	3.0	6	1	3500.11.08	50	
Pg 11	M10x1.5	21	3.0	6	1	3500.11.10	50	
Pg 11	M12x1.5	21	3.0	6	-	3500.11.12	50	
Pg 11	M16x1.5	21	8.0	6	-	3500.11.17	50	
Pg 13	M12x1.5	24	3.0	6	-	3500.13.12	50	
Pg 13	M16x1.5	24	3.0	6	-	3500.13.17	50	
Pg 16	M12x1.5	24	3.0	6	-	3500.16.12	25	
Pg 16	M16x1.5	24	3.0	6	-	3500.16.17	25	
Pg 16	M20x1.5	24	10.5	6	-	3500.16.20	25	
Pg 21	M16x1.5	30	3.5	7.5	-	3500.21.17	25	
Pg 21	M20x1.5	30	3.5	7.5	-	3500.21.20	25	
Pg 21	M25x1.5	30	10.5	7.5	-	3500.21.25	25	
Pg 29	M25x1.5	38	4.0	8	-	3500.29.25	20	
Pg 29	M32x1.5	38	13.0	8	-	3500.29.32	20	
Pg 36	M32x1.5	50	4.5	8	-	3500.36.32	10	
Pg 36	M40x1.5	50	4.5	8	-	3500.36.40	10	
Pg 42	M32x1.5	55	5.0	10	-	3500.42.32	10	
Pg 42	M40x1.5	55	5.0	10	-	3500.42.40	10	
Pg 42	M50x1.5	55	15.0	10	-	3500.42.50	10	
Pg 48	M40x1.5	65	5.5	11	-	3500.48.40	5	
Pg 48	M50x1.5	65	5.5	11	-	3500.48.50	5	

1 = Metrisches Regelgewinde

1 = Metric coarse-pitch thread

# Adapter Messing

## Adapter nickel-plated brass

mit 6-kant | hexagonal

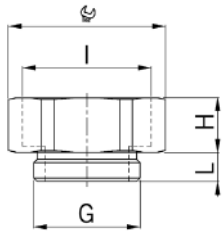



Material: Messing vernickelt  
 O-Ring: NBR  
 Einsatztemperatur: -40°C / +100°C  
 Schutzart: IP 68

Material: Nickel-plated brass  
 O-ring: NBR  
 Temperature range: -40°C / +100°C  
 Protection class: IP 68



Aussengewinde Pg  
 Innengewinde metrisch  
 mit O-Ring

Outer thread Pg  
 Inner thread metric  
 with O-ring

G	I	 mm	H mm	L mm	Art.-Nr.   Art. No.	
Pg 7	M12x1.5	15	9.0	6	3600.07.12	50
Pg 7	M16x1.5	18	9.0	6	3600.07.17	50
Pg 9	M16x1.5	18	9.5	6	3600.09.17	50
Pg 9	M20x1.5	24	10.5	6	3600.09.20	50
Pg 11	M20x1.5	24	10.5	6	3600.11.20	50
Pg 11	M25x1.5	30	11.5	6	3600.11.25	25
Pg 13	M20x1.5	24	10.5	6	3600.13.20	50
Pg 13	M25x1.5	30	11.5	6	3600.13.25	25
Pg 16	M25x1.5	30	11.5	6	3600.16.25	25
Pg 16	M32x1.5	36	13.5	6	3600.16.32	25
Pg 21	M32x1.5	36	14.0	7.5	3600.21.32	25
Pg 21	M40x1.5	46	14.0	7.5	3600.21.40	20
Pg 29	M40x1.5	46	14.0	8	3600.29.40	20
Pg 29	M50x1.5	55	16.0	8	3600.29.50	10
Pg 36	M50x1.5	55	16.0	8	3600.36.50	10
Pg 36	M63x1.5	70	17.0	8	3600.36.63	10
Pg 42	M63x1.5	70	17.0	10	3600.42.63	10
Pg 42	M75x1.5	80	18.0	10	3600.42.75	10
Pg 48	M63x1.5	70	17.0	11	3600.48.63	10
Pg 48	M75x1.5	80	18.0	11	3600.48.75	10

Runde Bauform, randriert | Round, knurled

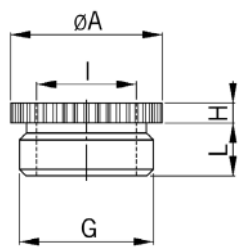

Material: Messing vernickelt  
 Einsatztemperatur: -40°C / +200°C  
 Schutzart: IP 54  
 Weitere Schutzart: IP 68, wenn Anschlussgewinde abgedichtet

Material: Nickel-plated brass  
 Temperature range: -40°C / +200°C  
 Protection class: IP 54  
 Further protection: IP 68, if the entry thread is sealed



Aussengewinde Pg  
 Innengewinde metrisch  
 ohne O-Ring

Outer thread Pg  
 Inner thread metric  
 without O-Ring

G	I	ØA mm	H mm	L mm	Art.-Nr.   Art. No.	
Pg 11	M16x1.5	20	10	6	3545.11.17	50
Pg 16	M20x1.5	24	11	6	3545.16.20	50
Pg 21	M20x1.5	30	3.5	7.5	3545.21.20	50
Pg 21	M25x1.5	30	11	7.5	3545.21.25	50
Pg 29	M25x1.5	39	4	8	3545.29.25	25
Pg 29	M32x1.5	39	4	8	3545.29.32	25
Pg 36	M40x1.5	50	4.5	8	3545.36.40	10

# Adapter Messing Adapter nickel-plated brass

## Runde Bauform | Round execution

Material:	Messing vernickelt	Material:	Nickel-plated brass
Einsatztemperatur:	-40°C / +200°C	Temperature range:	-40°C / +200°C
Schutzart:	IP 54	Protection class:	IP 54
Weitere Schutzart:	IP 68, wenn Anschlussgewinde abgedichtet	Further protection:	IP 68, if the entry thread is sealed

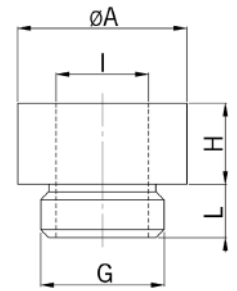

Aussengewinde Pg Innengewinde metrisch ohne O-Ring					Outer thread Pg Inner thread metric without O-Ring	
G	I	ØA mm	H mm	L mm	Art.-Nr.   Art. No.	
Pg 7	M12x1.5	14	9	6	3645.07.12	100
Pg 9	M16x1.5	19	9.5	6	3645.09.17	50
Pg 11	M20x1.5	22	11	6	3645.11.20	50
Pg 13	M20x1.5	22	11	6	3645.13.20	50
Pg 16	M25x1.5	27	11	6	3645.16.25	50
Pg 21	M32x1.5	34	12	7.5	3645.21.32	50
Pg 29	M40x1.5	42	12	8	3645.29.40	10



## mit 6-kant | hexagonal

Material:	Messing vernickelt	Material:	Nickel-plated brass
O-Ring:	NBR	O-ring:	NBR
Einsatztemperatur:	-40°C / +100°C	Temperature range:	-40°C / +100°C
Schutzart:	IP 68	Protection class:	IP 68

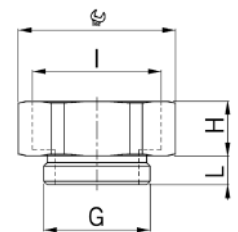

Aussengewinde Pg Innengewinde Gasrohr mit O-Ring					Outer thread Pg Inner thread gas-pipe with O-ring	
G	I	ØA mm	H mm	L mm	Art.-Nr.   Art. No.	
Pg 13	G3/8"	24	3	7	35133/8G	50
Pg 16	G1/2"	24	14	10	36161/2G.08	50
Pg 21	G3/4"	32	14	12	36213/4G.08	25
Pg 36	G 2"	64	20	12	3636.48.08	10
Pg 42	G 2"	64	20	15	3642.48.08	10



Aussengewinde Gasrohr Innengewinde Pg mit O-Ring					Outer thread gas-pipe Inner thread Pg with O-ring	
G	I	ØA mm	H mm	L mm	Art.-Nr.   Art. No.	
G3/8"	Pg 7	20	3	10	353/8G.07	50
G1/2"	Pg 9	24	3	9.5	351/2G.09	50
G3/4"	Pg 9	30	3.5	11	353/4G.09	50
G3/4"	Pg 11	30	3.5	11	353/4G.11	50
G3/4"	Pg 16	32	3.5	11	353/4G.16	50
G 1"	Pg 21	38	3.5	11	351G.21	25
G 1 1/4"	Pg 29	50	5	11	3511/4G.29	25
G 2"	Pg 36	64	5	11	352G.36	10
G 2"	Pg 42	64	5	11	352G.42	10



# Adapter Messing

## Adapter nickel-plated brass

mit 6-kant | hexagonal

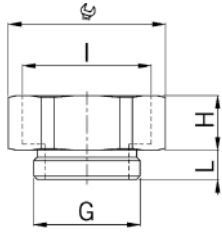

Material: Messing vernickelt  
 O-Ring: NBR  
 Einsatztemperatur: -40°C / +100°C  
 Schutzart: IP 68

Material: Nickel-plated brass  
 O-ring: NBR  
 Temperature range: -40°C / +100°C  
 Protection class: IP 68



Aussengewinde Gasrohr  
 Gewinde innen Pg  
 mit O-Ring

Outer thread gas-pipe  
 Inner thread Pg  
 with O-ring

G	I	 mm	H mm	L mm	Art.-Nr.   Art. No.	
G3/8"	Pg 11	20	12	10	363/8G.11.08	50
G1/2"	Pg 11	24	12	10	361/2G.11.08	50
G1/2"	Pg 13	24	12	10	361/2G.13.08	50
G1/2"	Pg 16	24	12	10	361/2G.16.08	50
G5/8"	Pg 16	24	12	10	365/8G.16.08	50
G3/4"	Pg 21	32	15	12	363/4G.21.08	25
G7/8"	Pg 29	41	15	12	367/8G.29.08	25
G 1"	Pg 29	41	15	11	361G.29.08	25
G 1 1/2"	Pg 36	54	22	12	3611/2G.36.08	10

mit 6-kant | hexagonal

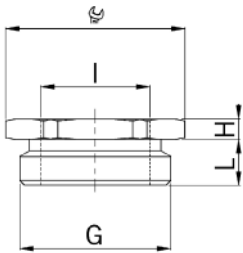

Material: Messing vernickelt  
 Einsatztemperatur: -40°C / +100°C  
 Schutzart: IP 68, wenn Anschlussgewinde abgedichtet

Material: Nickel-plated brass  
 Temperature range: -40°C / +100°C  
 Protection class: IP 68, if the entry thread is sealed



Aussengewinde NPT  
 Innengewinde Pg  
 ohne O-Ring

Outer thread NPT  
 Inner thread Pg  
 without O-Ring

G	I	 mm	H mm	L mm	Art.-Nr.   Art. No.	
NPT1/2"	Pg 9	22	4.5	20	351/2NPT.09	50
NPT3/4"	Pg 11	30	4	20	353/4NPT.11	10
NPT3/4"	Pg 13	30	4	20	353/4NPT.13	10
NPT 1"	Pg 16	36	6	26	351NPT.16	10



# Adapter Messing

## Adapter nickel-plated brass

mit 6-kant | hexagonal

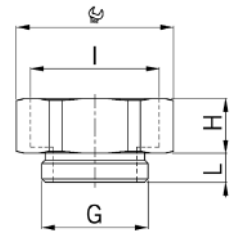
Material:	Messing vernickelt	Material:	Nickel-plated brass
O-Ring:	NBR	O-ring:	NBR
Einsatztemperatur:	-40°C / +100°C	Temperature range:	-40°C / +100°C
Schutzart:	IP 68, wenn Anschlussgewinde abgedichtet	Protection class:	IP 68, if the entry thread is sealed



Aussengewinde NPT Innengewinde Pg ohne O-Ring					Outer thread NPT Inner thread Pg without O-Ring	
G	I	 mm	H mm	L mm	Art.-Nr.   Art. No.	
NPT1/2"	Pg 11	24	12	20	361/2NPT.11	50
NPT1/2"	Pg 13	24	14	20	361/2NPT.13	50
NPT1/2"	Pg 16	34	20	20	361/2NPT.16	50
NPT3/4"	Pg 21	32	14	20	363/4NPT.21	25



1  
2  
3  
4  
5  
6  
7  
8  
9  
10  
11  
12



# Verschlusschrauben Messing

## Locking plugs nickel-plated brass

### Kurzes Anschlussgewinde metrisch | Short entry thread metric

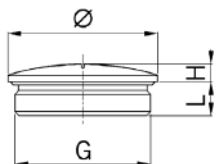

Material: Messing vernickelt  
 O-Ring: NBR  
 Einsatztemperatur: -40°C / +100°C  
 Schutzart: IP 68

Material: Nickel-plated brass  
 O-ring: NBR  
 Temperature range: -40°C / +100°C  
 Protection class: IP 68



Runde Bauform  
mit O-Ring

Round execution  
with O-ring

G	Ø mm	H mm	L mm	i info	Art.-Nr.   Art. No.	
<b>M6x1.0</b>	9	3	5	1	<b>8706.08</b>	50
<b>M8x1.25</b>	10	3	5	1	<b>8708.08</b>	50
<b>M10x1.5</b>	12	3	5	1	<b>8710.08</b>	50
<b>M12x1.5</b>	14	3	5	-	<b>8712.08</b>	50
<b>M16x1.5</b>	19	3	5	-	<b>8717.08</b>	50
<b>M20x1.5</b>	24	3	6	-	<b>8720.08</b>	25
<b>M25x1.5</b>	28	4	7	-	<b>8725.08</b>	25
<b>M32x1.5</b>	35	4	8	-	<b>8732.08</b>	10
<b>M40x1.5</b>	45	6	8	-	<b>8740.08</b>	10
<b>M50x1.5</b>	55	6	9	-	<b>8750.08</b>	10
<b>M63x1.5</b>	70	6	10	-	<b>8763.08</b>	10
<b>M75x1.5</b>	80	6	11	-	<b>8775.08</b>	5

1 = Metrisches Regelgewinde

1 = Metric coarse-pitch thread

### Langes Anschlussgewinde metrisch | Long entry thread metric



Runde Bauform  
mit O-Ring

Round execution  
with O-ring

G	Ø mm	H mm	L mm	i info	Art.-Nr.   Art. No.	
<b>M6x1.0</b>	9	3	8	1	<b>8706.11.08</b>	50
<b>M8x1.25</b>	10	3	10	1	<b>8708.11.08</b>	50
<b>M10x1.5</b>	12	3	10	1	<b>8710.11.08</b>	50
<b>M12x1.5</b>	14	3	10	-	<b>8712.11.08</b>	50
<b>M16x1.5</b>	19	3	10	-	<b>8717.11.08</b>	50
<b>M20x1.5</b>	24	3	10	-	<b>8720.11.08</b>	25
<b>M25x1.5</b>	28	4	11	-	<b>8725.11.08</b>	25
<b>M32x1.5</b>	35	4	13	-	<b>8732.11.08</b>	10
<b>M40x1.5</b>	45	6	13	-	<b>8740.11.08</b>	10
<b>M50x1.5</b>	55	6	14	-	<b>8750.11.08</b>	10
<b>M63x1.5</b>	70	6	15	-	<b>8763.11.08</b>	10
<b>M75x1.5</b>	80	6	15	-	<b>8775.11.08</b>	5

1 = Metrisches Regelgewinde

1 = Metric coarse-pitch thread

# Verschlusschrauben Messing

## Locking plugs nickel-plated brass

### Kurzes Anschlussgewinde metrisch | Short entry thread metric

Material: Messing vernickelt  
 Einsatztemperatur: -40°C / +200°C  
 Schutzart: IP 54  
 Weitere Schutzart: IP 68, wenn Anschlussgewinde abgedichtet

Material: Nickel-plated brass  
 Temperature range: -40°C / +200°C  
 Protection class: IP 54  
 Further protection: IP 68, if the entry thread is sealed

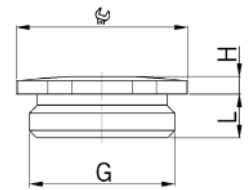

6-kant  
 ohne O-Ring

Hexagonal design  
 without O-Ring

G	$\frac{G}{mm}$	H	L	Art.-Nr.   Art. No.	
M12x1.5	14	2.5	5	8745.12	100
M16x1.5	18	2.5	5	8745.17	100
M20x1.5	22	2.5	6	8745.20	100
M25x1.5	27	3.0	7	8745.25	50
M32x1.5	34	3.5	8	8745.32	25
M40x1.5	42	4.0	8	8745.40	25
M50x1.5	52	4.0	9	8745.50	10
M63x1.5	65	4.0	10	8745.63	10



### Kurzes Anschlussgewinde Pg | Short entry thread Pg

Material: Messing vernickelt  
 O-Ring: NBR  
 Einsatztemperatur: -40°C / +100°C  
 Schutzart: IP 68

Material: Nickel-plated brass  
 O-ring: NBR  
 Temperature range: -40°C / +100°C  
 Protection class: IP 68

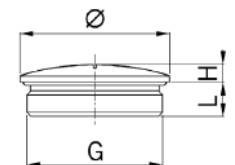

Runde Bauform  
 mit O-Ring

Round execution  
 with O-ring

G	$\frac{\varnothing}{mm}$	H	L	Art.-Nr.   Art. No.	
Pg 7	14	3	5	8707.08	100
Pg 9	17	3	6	8709.08	100
Pg 11	20	3	6	8711.08	100
Pg 13	22	3	6.5	8713.08	50
Pg 16	24	3	6.5	8716.08	50
Pg 21	30	4	7	8721.08	10
Pg 29	39	4	8	8729.08	10
Pg 36	50	6	9	8736.08	10
Pg 42	60	6	10	8742.08	10
Pg 48	65	6	10	8748.48.08	10
G 2"	65	6	10	8748.08	10



### Langes Anschlussgewinde Pg | Long entry thread Pg

Runde Bauform  
 mit O-Ring

Round execution  
 with O-ring

G	$\frac{\varnothing}{mm}$	H	L	Art.-Nr.   Art. No.	
Pg 7	14	3	10	8707.11.08	100
Pg 9	17	3	10	8709.11.08	100
Pg 11	20	3	10	8711.11.08	100
Pg 13	22	3	10	8713.11.08	50
Pg 16	24	3	10	8716.11.08	50
Pg 21	30	4	12	8721.11.08	10
Pg 29	39	4	12	8729.11.08	10
Pg 36	50	6	15	8736.11.08	10
G 2"	65	6	15	8748.11.08	10



# Gegenmuttern Kunststoff

## Synthetic lock nuts

### Anschlussgewinde metrisch | Entry thread metric

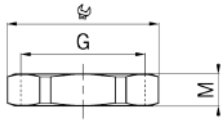

Material: Polyamid glasfaserverstärkt  
 Ausführung: 6-kant  
 Einsatztemperatur: -40°C / +100°C

Material: Polyamide glass fiber reinforced  
 Execution: Hexagonal design  
 Temperature range: -40°C / +100°C



Hellgrau RAL 7035

Light grey RAL 7035

G	 mm	M		Art.-Nr.   Art. No.	
M12x1.5	17	5.5		8212	100
M16x1.5	22	5.5		8217	100
M20x1.5	26	6.5		8220	100
M25x1.5	32	7.0		8225	100
M32x1.5	41	7.0		8232	100
M40x1.5	50	7.0		8240	50
M50x1.5	60	8.5		8250	10



Schwarz RAL 9005

Black RAL 9005

G	 mm	M		Art.-Nr.   Art. No.	
M12x1.5	17	5.5		8212.40	100
M16x1.5	22	5.5		8217.40	100
M20x1.5	26	6.5		8220.40	100
M25x1.5	32	7.0		8225.40	100
M32x1.5	41	7.0		8232.40	100
M40x1.5	50	7.0		8240.40	50
M50x1.5	60	8.5		8250.40	10

### Anschlussgewinde Pg | Entry thread Pg



Hellgrau RAL 7035

Light grey RAL 7035

G	 mm	M		Art.-Nr.   Art. No.	
Pg 7	19	5.0		8207	100
Pg 9	22	6.0		8209	100
Pg 11	24	6.0		8211	100
Pg 13	27	6.0		8213	100
Pg 16	30	6.0		8216	100
Pg 21	36	7.0		8221	100
Pg 29	46	7.0		8229	50
Pg 36	60	8.0		8236	25
Pg 42	65	8.0		8242	25
Pg 48	70	8.0		8248.48	25



Schwarz RAL 9005

Black RAL 9005

G	 mm	M		Art.-Nr.   Art. No.	
Pg 7	19	5.0		8207.40	100
Pg 9	22	6.0		8209.40	100
Pg 11	24	6.0		8211.40	100
Pg 13	27	6.0		8213.40	100
Pg 16	30	6.0		8216.40	100
Pg 21	36	7.0		8221.40	100
Pg 29	46	7.0		8229.40	50
Pg 36	60	8.0		8236.40	25
Pg 42	65	8.0		8242.40	25
Pg 48	70	8.0		8248.48.40	25

### Anschlussgewinde metrisch | Entry thread metric

Material: Polyamid PA 6  
 Eigenschaften: halogenfrei  
 Ausführung: 6-kant mit Flansch  
 Einsatztemperatur: -30°C / +100°C

Material: Polyamide PA 6  
 Properties: halogen-free  
 Execution: Hexagonal design with flange  
 Temperature range: -30°C / +100°C

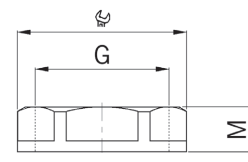

Hellgrau RAL 7035

Light grey RAL 7035

G	 mm	M		Art.-Nr.   Art. No.	
M12x1.5	17	5.0		8255.12	100
M16x1.5	22	5.0		8255.17	100
M20x1.5	27	6.0		8255.20	100
M25x1.5	33	6.7		8255.25	100
M32x1.5	42	7.9		8255.32	50
M40x1.5	48	8.4		8255.40	50
M50x1.5	59	9.9		8255.50	10
M63x1.5	73	11.0		8255.63	10



Schwarz RAL 9005

Black RAL 9005

G	 mm	M		Art.-Nr.   Art. No.	
M12x1.5	17	5.0		8245.12	100
M16x1.5	22	5.0		8245.17	100
M20x1.5	27	6.0		8245.20	100
M25x1.5	33	6.7		8245.25	100
M32x1.5	42	7.9		8245.32	50
M40x1.5	48	8.4		8245.40	50
M50x1.5	59	9.9		8245.50	10
M63x1.5	73	11.0		8245.63	10



### Anschlussgewinde Pg | Entry thread Pg

Hellgrau RAL 7035

Light grey RAL 7035

G	 mm	M		Art.-Nr.   Art. No.	
Pg 7	19	5.0		8255.07	100
Pg 9	21	5.0		8255.09	100
Pg 11	24	5.0		8255.11	100
Pg 13	27	6.0		8255.13	100
Pg 16	30	6.0		8255.16	100
Pg 21	36	7.0		8255.21	50
Pg 29	46	8.0		8255.29	25
Pg 36	59	8.0		8255.36	25
Pg 42	65	8.0		8255.42	10
Pg 48	69	8.0		8255.48	10



Schwarz RAL 9005

Black RAL 9005

G	 mm	M		Art.-Nr.   Art. No.	
Pg 7	19	5.0		8245.07	100
Pg 9	21	5.0		8245.09	100
Pg 11	24	5.0		8245.11	100
Pg 13	27	6.0		8245.13	100
Pg 16	30	6.0		8245.16	100
Pg 21	36	7.0		8245.21	50
Pg 29	46	8.0		8245.29	50
Pg 36	59	8.0		8245.36	25
Pg 42	65	8.0		8245.42	10
Pg 48	69	8.0		8245.48	10



# Reduktionen Kunststoff

## Synthetic reduction fittings

### mit 6-kant | hexagonal

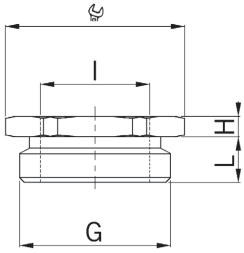

Material: Polyamid PA 6  
 Eigenschaften: halogenfrei  
 Einsatztemperatur: -30°C / +100°C  
 Schutzart: IP 54  
 Weitere Schutzart: IP 68, wenn Anschlussgewinde abgedichtet

Material: Polyamide PA 6  
 Properties: halogen-free  
 Temperature range: -30°C / +100°C  
 Protection class: IP 54  
 Further protection: IP 68, if the entry thread is sealed



Aussengewinde metrisch Innengewinde metrisch Hellgrau RAL 7035		Outer thread metric Inner thread metric Light grey RAL 7035		Art.-Nr.   Art. No.		
G	I	 mm	H mm	L mm		
M16x1.5	M12x1.5	22	4	8	3455.17.12	100
M20x1.5	M12x1.5	24	4	8	3455.20.12	100
M20x1.5	M16x1.5	24	4	8	3455.20.17	100
M25x1.5	M12x1.5	29	6	8	3455.25.12	100
M25x1.5	M16x1.5	29	6	8	3455.25.17	100
M25x1.5	M20x1.5	29	6	8	3455.25.20	100
M32x1.5	M12x1.5	36	6	10	3455.32.12	50
M32x1.5	M16x1.5	36	6	10	3455.32.17	50
M32x1.5	M20x1.5	36	6	10	3455.32.20	50
M32x1.5	M25x1.5	36	6	10	3455.32.25	50
M40x1.5	M16x1.5	46	6	10	3455.40.17	50
M40x1.5	M20x1.5	46	6	10	3455.40.20	50
M40x1.5	M25x1.5	46	6	10	3455.40.25	25
M40x1.5	M32x1.5	46	6	10	3455.40.32	25
M50x1.5	M20x1.5	55	6	12	3455.50.20	5
M50x1.5	M25x1.5	55	6	12	3455.50.25	5
M50x1.5	M32x1.5	55	6	12	3455.50.32	5
M50x1.5	M40x1.5	55	6	12	3455.50.40	5
M63x1.5	M25x1.5	68	6	12	3455.63.25	5
M63x1.5	M32x1.5	68	6	12	3455.63.32	5
M63x1.5	M40x1.5	68	6	12	3455.63.40	5
M63x1.5	M50x1.5	68	6	12	3455.63.50	5

### mit 6-kant | hexagonal

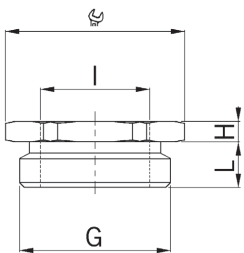

Material: Polyamid glasfaserverstärkt  
 Einsatztemperatur: -20°C / +100°C  
 Schutzart: IP 54  
 Weitere Schutzart: IP 68, wenn Anschlussgewinde abgedichtet

Material: Polyamide glass fiber reinforced  
 Temperature range: -20°C / +100°C  
 Protection class: IP 54  
 Further protection: IP 68, if the entry thread is sealed



Aussengewinde Pg Innengewinde Pg Hellgrau		Outer thread Pg Inner thread Pg Light grey		Art.-Nr.   Art. No.		
G	I	 mm	H mm	L mm		
Pg 9	Pg 7	19	12	8	3409.07	50
Pg 11	Pg 7	22	3	8	3411.07	50
Pg 11	Pg 9	22	15	8	3411.09	50
Pg 13	Pg 9	24	3	9	3413.09	50
Pg 13	Pg 11	24	15	9	3413.11	50
Pg 16	Pg 9	27	5	9	3416.09	50
Pg 16	Pg 11	27	5	9	3416.11	50
Pg 16	Pg 13	27	17	10	3416.13	50
Pg 21	Pg 13	32	5	11	3421.13	25
Pg 21	Pg 16	32	5	11	3421.16	25
Pg 29	Pg 21	41	6	12	3429.21	10
Pg 36	Pg 29	50	6	14	3436.29	10

## rund mit 6-kant | round with hexagon

Material: Polyamid PA 6  
Eigenschaften: halogenfrei  
Einsatztemperatur: -30°C / +100°C  
Schutzart: IP 54  
Weitere Schutzart: IP 68, wenn Anschlussgewinde abgedichtet

Material: Polyamide PA 6  
Properties: halogen-free  
Temperature range: -30°C / +100°C  
Protection class: IP 54  
Further protection: IP 68, if the entry thread is sealed

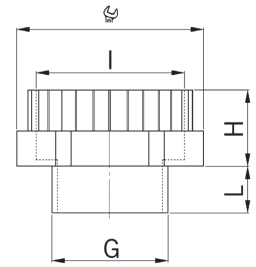

Aussengewinde metrisch  
Innengewinde metrisch  
Hellgrau RAL 7035

Outer thread metric  
Inner thread metric  
Light grey RAL 7035

G	I	 mm	H mm	L mm	Art.-Nr.   Art. No.	
<b>M12x1.5</b>	M16x1.5	20	13	8	<b>3755.12.17</b>	100
<b>M16x1.5</b>	M20x1.5	24	13	8	<b>3755.17.20</b>	100
<b>M20x1.5</b>	M25x1.5	29	13	8	<b>3755.20.25</b>	100
<b>M25x1.5</b>	M32x1.5	36	15	8	<b>3755.25.32</b>	50
<b>M32x1.5</b>	M40x1.5	46	15	10	<b>3755.32.40</b>	25
<b>M40x1.5</b>	M50x1.5	55	15	10	<b>3755.40.50</b>	10
<b>M50x1.5</b>	M63x1.5	68	15	10	<b>3755.50.63</b>	10

## rund mit 6-kant | round with hexagon

Material: Polyamid glasfaserverstärkt  
Einsatztemperatur: -20°C / +100°C  
Schutzart: IP 54, IP 68 wenn Anschlussgewinde abgedichtet

Material: Polyamide glass fiber reinforced  
Temperature range: -20°C / +100°C  
Protection class: IP 54, IP 68 if the thread is sealed

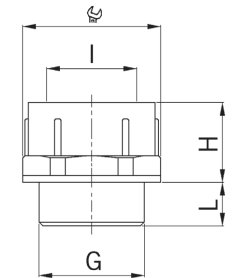

Aussengewinde Pg  
Innengewinde Pg  
Hellgrau

Outer thread Pg  
Inner thread Pg  
Light grey

G	I	 mm	H mm	L mm	Art.-Nr.   Art. No.	
<b>Pg 7</b>	Pg 9	19	18	7	<b>3707.09</b>	50
<b>Pg 9</b>	Pg 11	22	19	7	<b>3709.11</b>	50
<b>Pg 11</b>	Pg 13	24	21	8	<b>3711.13</b>	50
<b>Pg 13</b>	Pg 16	27	23	9	<b>3713.16</b>	50
<b>Pg 16</b>	Pg 21	32	26	9	<b>3716.21</b>	25
<b>Pg 21</b>	Pg 29	41	33	10	<b>3721.29</b>	25
<b>Pg 29</b>	Pg 36	55	39	12	<b>3729.36</b>	10
<b>Pg 36</b>	Pg 42	60	46	14	<b>3736.42</b>	10
<b>Pg 42</b>	Pg 48	65	39	16	<b>3742.48</b>	10



# Adapter Kunststoff

## Synthetic adapter

rund mit 6-kant | round with hexagon

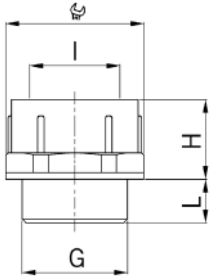



Material: Polyamid glasfaserverstärkt  
 Einsatztemperatur: -20°C / +100°C  
 Schutzart: IP 54  
 Weitere Schutzart: IP 68, wenn Anschlussgewinde abgedichtet

Material: Polyamide glass fiber reinforced  
 Temperature range: -20°C / +100°C  
 Protection class: IP 54  
 Further protection: IP 68, if the entry thread is sealed



Aussengewinde metrisch  
 Innengewinde Pg  
 Hellgrau



Outer thread metric  
 Inner thread Pg  
 Light grey

G	I	 mm	H mm	L mm	Art.-Nr.   Art. No.	
<b>M12x1.5</b>	Pg 9	19	13	11	<b>3712.09</b>	50
<b>M20x1.5</b>	Pg 13	24	15	11	<b>3720.13</b>	50
<b>M20x1.5</b>	Pg 16	27	17	11	<b>3720.16</b>	50
<b>M25x1.5</b>	Pg 21	33	20	11	<b>3725.21</b>	25
<b>M32x1.5</b>	Pg 29	42	22	11	<b>3732.29</b>	25
<b>M50x1.5</b>	Pg 42	60	28	11	<b>3750.42</b>	10



Aussengewinde metrisch  
 Innengewinde Pg  
 Hellgrau

Outer thread metric  
 Inner thread Pg  
 Light grey



G	I	 mm	H mm	L mm	Art.-Nr.   Art. No.	
<b>M16x1.5</b>	Pg 9	19	14	11	<b>3417.09</b>	50
<b>M20x1.5</b>	Pg 11	22	16	11	<b>3420.11</b>	50
<b>M25x1.5</b>	Pg 16	27	18	11	<b>3425.16</b>	50
<b>M40x1.5</b>	Pg 29	42	23	11	<b>3440.29</b>	25
<b>M50x1.5</b>	Pg 36	53	26	11	<b>3450.36</b>	10
<b>M63x1.5</b>	Pg 48	65	29	11	<b>3463.48</b>	5

rund mit 6-kant | round with hexagon

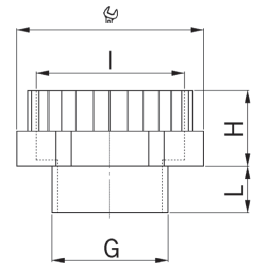

Material: Polyamid PA 6  
Eigenschaften: halogenfrei  
Einsatztemperatur: -30°C / +100°C  
Schutzart: IP 54  
Weitere Schutzart: IP 68, wenn Anschlussgewinde abgedichtet

Material: Polyamide PA 6  
Properties: halogen-free  
Temperature range: -30°C / +100°C  
Protection class: IP 54  
Further protection: IP 68, if the entry thread is sealed



Aussengewinde Pg Innengewinde metrisch Hellgrau RAL 7035					Outer thread Pg Inner thread metric Light grey RAL 7035	
G	I	 mm	H mm	L mm	Art.-Nr.   Art. No.	
Pg 7	M12x1.5	15	12	8	3755.07.12	100
Pg 7	M16x1.5	20	12	8	3755.07.17	100
Pg 9	M16x1.5	20	12	8	3755.09.17	100
Pg 9	M20x1.5	24	12	8	3755.09.20	100
Pg 11	M20x1.5	24	12	8	3755.11.20	100
Pg 13	M25x1.5	30	13	9	3755.13.25	100
Pg 16	M25x1.5	30	13	10	3755.16.25	50
Pg 21	M32x1.5	37	14	11	3755.21.32	50
Pg 29	M40x1.5	45	14	11	3755.29.40	50
Pg 42	M50x1.5	55	17	11	3755.42.50	10
Pg 48	M63x1.5	68	17	11	3755.48.63	5



Aussengewinde Pg Innengewinde metrisch Hellgrau RAL 7035					Outer thread Pg Inner thread metric Light grey RAL 7035	
G	I	 mm	H mm	L mm	Art.-Nr.   Art. No.	
Pg 9	M12x1.5	19	12	8	3455.09.12	100
Pg 11	M16x1.5	22	12	8	3455.11.17	100
Pg 13	M16x1.5	24	13	9	3455.13.17	100
Pg 13	M20x1.5	24	13	9	3455.13.20	100
Pg 16	M20x1.5	27	13	10	3455.16.20	50
Pg 21	M25x1.5	33	14	11	3455.21.25	50
Pg 29	M32x1.5	42	14	11	3455.29.32	50
Pg 36	M40x1.5	55	14	11	3455.36.40	25



1  
2  
3  
4  
5  
6  
7  
8  
9  
10  
11  
12

# Verschlusschrauben Kunststoff

## Synthetic locking plugs

### Gewinde metrisch | Metric thread

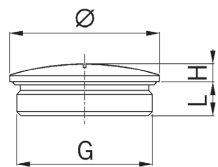

Material: Polyamid PA 6  
 Einsatztemperatur: -30°C / +100°C  
 Schutzart: IP 54  
 Weitere Schutzart: IP 68, wenn Anschlussgewinde abgedichtet

Material: Polyamide PA 6  
 Temperature range: -30°C / +100°C  
 Protection class: IP 54  
 Further protection: IP 68, if the entry thread is sealed



Hellgrau RAL 7035  
 ohne O-Ring

Light grey RAL 7035  
 without O-Ring

G	Ø mm	H mm	L mm	Art.-Nr.   Art. No.	
M12x1.5	15	4.5	6	8855.12	100
M16x1.5	20	4.5	6	8855.17	100
M20x1.5	24	4.5	6	8855.20	100
M25x1.5	30	5.0	8	8855.25	100
M32x1.5	37	5.5	8	8855.32	50
M40x1.5	46	6.0	8	8855.40	50
M50x1.5	56	6.0	10	8855.50	10
M63x1.5	70	6.0	12	8855.63	10



Schwarz RAL 9005  
 ohne O-Ring

Black RAL 9005  
 without O-Ring

G	Ø mm	H mm	L mm	Art.-Nr.   Art. No.	
M12x1.5	15	4.5	6	8845.12	100
M16x1.5	20	4.5	6	8845.17	100
M20x1.5	24	4.5	6	8845.20	100
M25x1.5	30	5.0	8	8845.25	100
M32x1.5	37	5.5	8	8845.32	50
M40x1.5	46	6.0	8	8845.40	50
M50x1.5	56	6.0	10	8845.50	10
M63x1.5	70	6.0	12	8845.63	10

### Anschlussgewinde Pg | Entry thread Pg

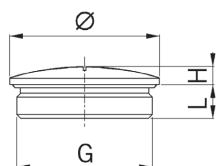

Material: schlagfestes Material: Polypropylen  
 Einsatztemperatur: -20°C / +80°C  
 Schutzart: IP 54, IP 68 wenn Anschlussgewinde abgedichtet

Material: Shock-resistant polystyrene  
 Temperature range: -20°C / +80°C  
 Protection class: IP 54, IP 68 if the thread is sealed



Hellgrau RAL 7035  
 ohne O-Ring

Light grey RAL 7035  
 without O-Ring

G	Ø mm	H mm	L mm	Art.-Nr.   Art. No.	
Pg 7	15	2.0	6.0	8807	100
Pg 9	19	3.0	6.5	8809	100
Pg 11	22	3.5	6.5	8811	100
Pg 13	25	3.5	6.5	8813	100
Pg 16	27	3.5	6.5	8816	100
Pg 21	33	4.0	8.0	8821	100
Pg 29	44	4.0	8.0	8829	50
Pg 36	55	4.0	10.0	8836	25
Pg 42	62	6.0	10.0	8842	10
Pg 48	69	5.0	12.0	8848.48	25



Prüfzeichen Approval Marks	<b>182 - 183</b>	1
Kabelschutzschläuche und Kabelverschraubungen in Schienenfahrzeugen Cable protective conduits and cable glands in railway vehicles	<b>184 - 189</b>	2
Sonderlösungen Special solutions	<b>190 - 191</b>	3
AGRO Prüftechnik AGRO Test laboratory	<b>192 - 193</b>	4
Brandschutzklassen / Zuordnungstabelle Kabelschutzschlauch - Schlauchverschraubung Fire protection classes / Assignment chart cable protective conduit - conduit gland	<b>194</b>	5
Verzeichnis der Schutzarten (IP) List of Protection Classes	<b>195</b>	6
Fachgerechtes Trennen von Schutzschläuchen Professional cutting of protective conduits	<b>196 - 197</b>	7
Materialübersichtstabellen List of materials	<b>198 - 201</b>	8
Gewindetabelle Chart of threads	<b>202</b>	10
Schlüssel zu Klassifizierungscode Key to classification coding	<b>203</b>	11
Suchhilfe Search helps	<b>204 - 214</b>	<b>12</b>



### SEV

Das SEV-Bewilligungszeichen wird auf Grund bestandener Prüfungen bei ElectroSuisse vom ESTI erteilt. Grundlage für Kabelverschraubungen ist hierbei die europäische Norm EN 62444.

### SEV

The SEV mark of approval is awarded by ESTI as a result of tests conducted by ElectroSuisse. European standard EN 62444 forms the basis for cable glands.



### VDE

Das VDE-Zeichen kennzeichnet die Konformität mit den VDE-Bestimmungen bzw. europäischen oder international harmonisierten Normen und bestätigt die Einhaltung der Schutzanforderungen der zutreffenden Richtlinien. Das VDE-Zeichen steht für die Sicherheit des Produktes hinsichtlich elektrischer, mechanischer, thermischer und sonstiger Gefährdung.

### VDE

The VDE certification mark signals conformity with the VDE provisions and European or internationally harmonised standards and confirms that the safety requirements fulfil the applicable guidelines. The VDE mark stands for the safety of the product in terms of electrical, mechanical, thermal and other hazards.



### C-UL / US Listing Zeichen

Dieses Prüfzeichen wird bei Produkten verwendet, die auf kanadischen und U.S.-Märkten vertrieben werden. Es weist darauf hin, dass die kanadischen und die U.S.-Anforderungen für klassifizierbare Produkte erfüllt wurden.

### C-UL / US Listing Mark

This approval mark is used for products that are distributed in the US and Canadian markets. It indicates that the US and Canadian specifications for classifiable products have been fulfilled.



### Recognized Component Zeichen für Kanada und die USA

Das Recognized Component Mark von UL darf für Komponenten verwendet werden, die Bestandteil eines grösseren Produktes oder Systems sind. Diese sind von UL gemäss kanadischen und U.S.-Anforderungen zertifiziert.

### Recognized Component Mark for Canada and the USA

The UL Recognized Component Mark can be used for components that are part of a larger product or system. These are certified by UL in accordance with US and Canadian requirements.



Das Zertifikat der **Zollunion - EAC** ist ein offizieller Nachweis dafür, dass die Produkte den nationalen technischen Vorschriften der teilnehmenden Länder entsprechen. Als Vorbild für das neue gemeinsame Zertifizierungssystem wurde das russische TR Zertifizierungsverfahren hergenommen.

Die Erzeugnisse, deren Konformität mit den technischen Vorschriften durch das Zertifikat der Zollunion bescheinigt wird, dürfen frei im ganzen Zollgebiet aller Mitgliedstaaten der Zollunion über die Grenzen bewegt und verkauft werden.

The **EAC customs union certificate** is official proof that a product complies with the national technical regulations of the participating countries. The Russian TR certification process was used as a model in developing the new common certification system.

Products whose conformity with technical regulations have been verified by the customs union's certificate may be freely moved across borders and sold across the entire free trade area.

**Det Norske Veritas (DNV)** ist eine Schiffsklassifikations-Gesellschaft in Form einer Stiftung. Sie klassiert und erteilt Zertifikate zum unbedenklichen Einsatz von Produkten auf Schiffen. DNV wurde 1864 in Oslo gegründet

**Det Norske Veritas (DNV)** is a maritime classification society organized as a foundation. It classifies and issues certificates for the safe use of materials and components on ships. DNV was founded in 1864 in Oslo.



1

Das IEC Ex-Prüfzeichen ist eine spezielle Kennzeichnung für Explosionsschutz Einrichtungen. Es bedeutet, dass Einrichtungen, Schutzsysteme oder Bauteile den Anforderungen der internationalen und europäischen Norm entsprechen, die mit der Richtlinie 94/9/EC (ATEX-Direktive, benannt nach der französischen Bezeichnung „ATmosphäre EXplosible“) harmonisiert sind.

The IEC Ex mark of conformity is a special identification for equipment and services used in explosive atmospheres. It means that equipment, protective systems or components meet the requirements of the international and European standard which are harmonised with Directive 94/9/EC (the ATEX directive, named after the French designation "ATmosphères EXplosives").



2

3

Die EN 45545 setzt sich aus mehreren Teilen zusammen und definiert den Brandschutz in Schienenfahrzeugen. Teil 1 umfasst allgemeine Regeln, Teil 2 (EN 45545-2) ist in Bezug auf gefährliche Rauchgase sehr wichtig und Teil 3 (EN 45545-3) definiert den Feuerwiderstand von Feuerschutzabschlüssen (Raumabschlüsse).

The EN 45545 standard consists of several parts. Part 1 covers general requirements, part 2 (EN 45545-2) is very important in relation to dangerous smoke gases and part 3 (EN 45545-3) defines the fire resistance requirements for fire barriers.



4

5

Die **amerikanische Norm NFPA 130** definiert die zulässigen Werte für die Wärmefreisetzung und Rauchentwicklung (ASTM E 1354) sowie die Rauchgas Toxizität (SMP 800) für Produkte, welche in Schienenfahrzeugen zur Anwendung kommen.

The american standard NFPA 130 specifies permitted values for heat release and smoke emission (ASTM E 1354) as well as smoke toxicity (SMP 800) of products for use in rolling stock applications.



7

8

DIN 5510-2: Vorbeugender Brandschutz in Schienenfahrzeugen - Teil 2: Brennverhalten und Brandnebenscheinungen von Werkstoffen und Bauteilen - Klassifizierung, Anforderungen und Prüfverfahren.

DIN 5510-2: preventive fire protection in railway vehicles - part 2: Flammability and fire side effects of materials and building components - classification, requirements and test procedures.



9

10

Die NFF 16101/102: dient zur Klassifizierung von nicht metallischen Werkstoffen, die in Schienenfahrzeugen zur Verwendung kommen, bezüglich des Brandverhaltens und bezüglich der Opazität und Toxizität der Rauchgasemissionen im Falle der Verbrennung der Werkstoffe.

The standards NRR 16101/102 serve to classify non-metallic materials which are used in rolling stock applications with regard to flammability, smoke development, toxicity and opacity in case of fire.



11

12



# Sonderlösung Schienenfahrzeug

## Special solutions for railway vehicles

### Anforderungen

- EMV-gerechte Einführung von sechs ungeschirmten Kabeln
- Verbindung Stromrichter - Trafo
- Schutzart IP68 innen und aussen. Dadurch wird verhindert, dass Kondenswasser, welches sich möglicherweise innerhalb des Schlauches bildet, in den Traforaum eindringt

### AGRO-Lösung

- Progress®-Spezialverschraubung M75 mit geschlitztem Multi-Dicht-einsatz zur leichteren Kabelmontage
- kombiniert mit Metallschutzschlauch

### Requirements

- EMC-proof feedthrough of six unshielded cables
- Connection from power rectifier to transformer
- Protection class IP68 inside and out. This prevents condensate which could possibly build up inside the conduits from making its way into the transformer room

### The AGRO solution

- Progress® M75 special cable gland with slotted multi-sealing insert for easier cable assembly
- Combined with metal conduit

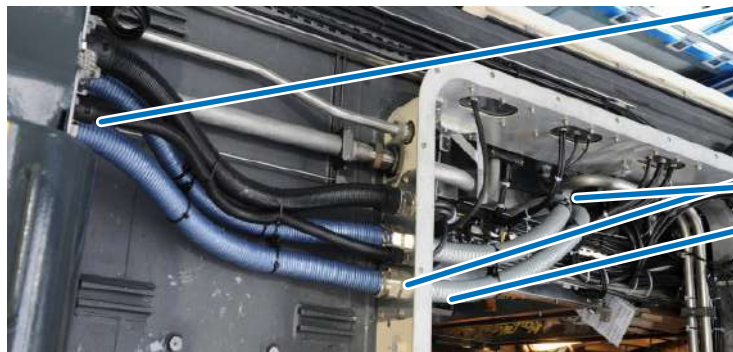

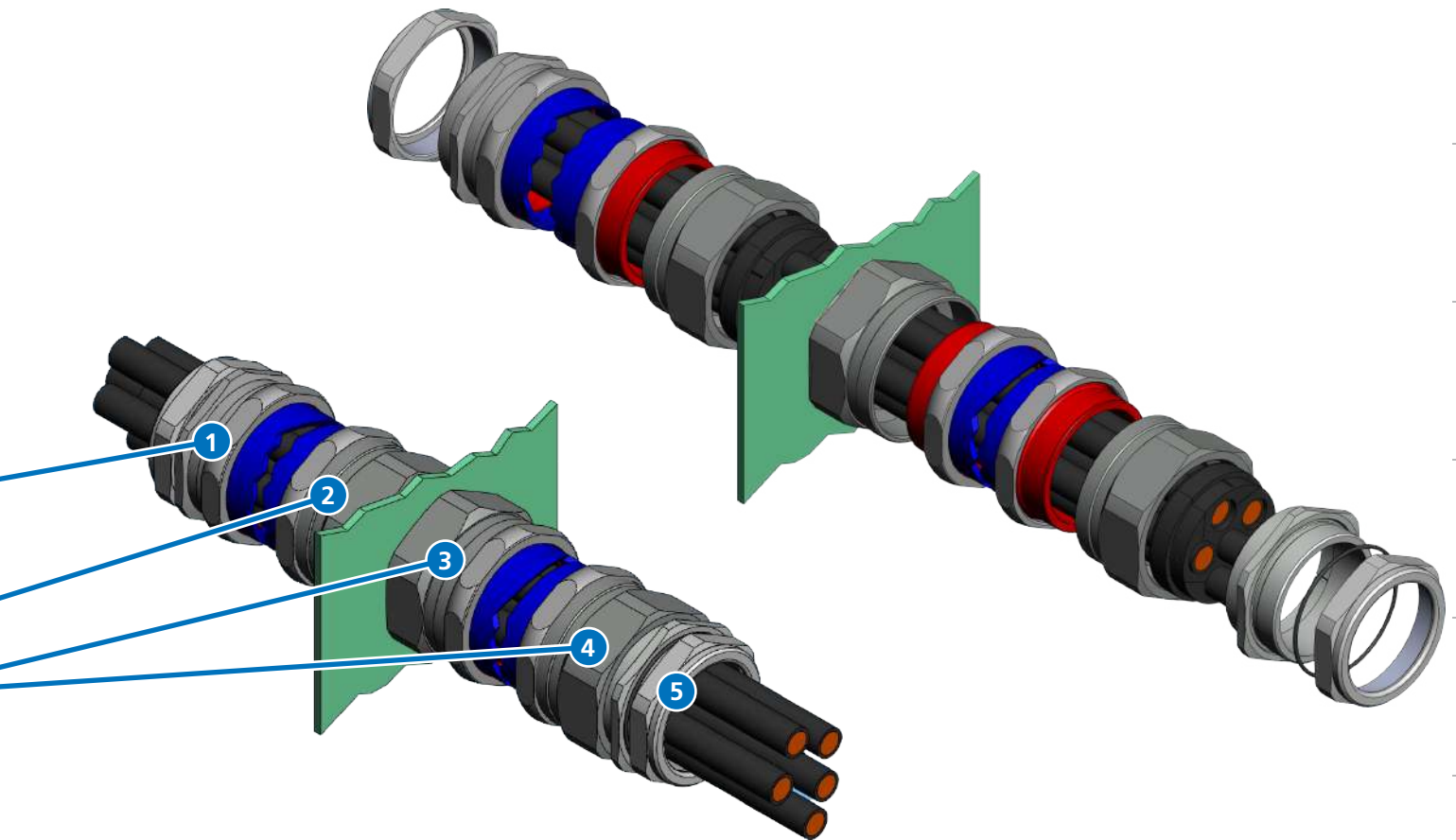

- 1 Schlauchverschraubung zur Befestigung des Metall-Kabelschutzschlauches. Innerhalb des Schutzschlauches werden sechs Stromkabel geführt. Der Metallschutzschlauch funktioniert über seine Verbindung mit den Gehäusen aus Metall als äußerer EMV-Schutz
- 2 Kombi-Schlauchverschraubung mit Progress® Multi-Dichteinsatz zur dichten Einführung der Kabel in den Traforaum (Schutz vor Feuchtigkeit von aussen)
- 3 Schlauchverschraubung zur Aufnahme des Metallschutzschlauches (Weiterführung des EMV-Schutzes)
- 4 Kombi-Schlauchverschraubung (identisch mit 2) zur Einführung der Kabel in den Trafo (Schutz vor Feuchtigkeit von innen)
- 5 Gegenmutter zur Befestigung der Kombi-Schlauchverschraubung

- 1 Conduit gland to secure the metal conduit. Six power cables are run within the conduit. The metal conduit functions as an exterior EMC shield through its connection with the metal enclosures
- 2 Combination conduit gland with Progress® multi-sealing insert for sealed cable feedthrough into the transformer room (protection from outside moisture)
- 3 Conduit gland to accept the metal conduit (extension of EMC protection)
- 4 Combination conduit gland (identical to #2) for cable feedthrough into the transformer room (protection from interior moisture)
- 5 Locknut to secure the combination conduit gland



# Anwendungsbereiche für Kabelschutzschläuche in Schienenfahrzeugen

## Cable protective conduits in railway vehicles

Aussenbereich		Outdoor application
Produkte Products	Dynamisch   statisch min. IP 67 🌡️ -50°C bis +100°C	Dynamic   static min. IP 67 🌡️ -50°C up to +100°C
	ROHRflex® PA 12 ROHRflex® PA 12-D	SPR - PU - AS FLEXAgraff®-PU - F

Innenbereich		Indoor application
Produkte Products	Statisch min. IP 54 🌡️ -40°C bis +100°C	Static min. IP 54 🌡️ -40°C up to +100°C
	ROHRflex® PA 6 FLEXAgraff®-PU - F	SPR SPR - CU - AS [EMV   emc]

Bezüglich Zertifikate und Zulassungen von Kabelschutzschläuchen, wenden Sie sich bitte direkt an Ihren Ansprechpartner im Vertrieb.

For certificates and approvals for cable protection conduits, please contact your sales contact directly.



Kupplungsbereich		Coupling
Produkte Products	Dynamisch   statisch min. IP 67 🌡️ -50°C bis +100°C	Dynamic   static min. IP 67 🌡️ -50°C up to +100°C
	ROHRflex® PA 12	ROHRflex® PA 12-D

Unterflur		Underfloor
Produkte Products	Statisch min. IP 54 🌡️ -40°C bis +100°C	Static min. IP 54 🌡️ -40°C up to +100°C
	ROHRflex® PA 12 ROHRflex® PA 12-D	SPR - PU - AS FLEXAgraff®-PU - F

### Kabelschutz in Schienenfahrzeugen

Für den Kabelschutz in Schienenfahrzeugen und an den Schienenstrecken wird Schutzschlauchtechnik aus Kunststoffen eingesetzt. Alle Kunststoffe müssen brandtechnisch untersucht werden, um den Personenschutz im Brandfall zu gewährleisten. Die verschiedenen internationalen Normen untersuchen im Wesentlichen die gleichen Parameter:

#### Brandverhalten

Die meisten der eingesetzten Kunststoffe sind selbstverlöschend und verhindern somit eine Ausbreitung des Feuers.

#### Rauchentwicklung

Um eine sichere Evakuierung der Personen zu gewährleisten, ist eine geringe Rauchentwicklung notwendig.

#### Rauchgastoxizität

Die für die Schienenfahrzeugindustrie verwendeten Kunststoffe sind halogenfrei (Fluor, Chlor und Brom).

Rauchgase werden beim Verbrennen von Kunststoffen freigesetzt. Es ist wichtig, diese Gase zu minimieren, um die Brandfolgeerscheinungen beim Menschen so gering wie möglich zu halten.

### Cable protection in railway vehicles

All cable protection in rolling stock and in rail infrastructure use plastic products to protect against water and dust. The material must be investigated in terms of fire and smoke regulations, to ensure personal safety in case of fire. The various international standards examine essentially the same parameters:

#### Flammability

Most of the plastic products used are self-extinguishing and thus prevent the spread of fire.

#### Smoke

In order to ensure safe evacuation of people, a low smoke development is required.

#### Smoke Toxicity

Products for the railway industry are made from halogen-free materials (fluorine, chlorine and bromine).

Smoke gases are emitted when burning plastics. It is important to minimise these gases to keep the fire-effects on humans as low as possible.

EN 45545		
Tests	Das Ziel dieser europäischen Norm ist es, die Brandanforderungen der Schienenfahrzeugtechnik für ganz Europa in einer Norm zu harmonisieren. Teil 1 und Teil 2 aus dieser siebenteiligen Norm beschäftigen sich mit Kabelführungssystemen. Der Fahrzeugtyp und die Einsatzumgebung werden in Gefahrenstufen eingeteilt [HL].	The target of this European standard is to harmonize the fire requirements of the rolling technology all over Europe in one standard. Part 1 and Part 2 of this seven-part standard have a focus on the cable systems. the type of vehicle and the operational environment are classified into hazard levels [HL].
	- Brandverhalten (Sauerstoffindex) - Rauchentwicklung - Rauchtoxizität	- flammability (Oxygen Index) - smoke emission - smoke toxicity
Produkte Products	ROHRflex® PA 6 ROHRflex® PA 12 ROHRflex® PA 12-F FLEXAquick®-system	SPR - PU - F FLEXAgraff®-PU - F HG - PET022

# AGRO Kabelverschraubungen sind zertifiziert nach EN 45545-2

## AGRO cable glands are certified according to EN 45545-2

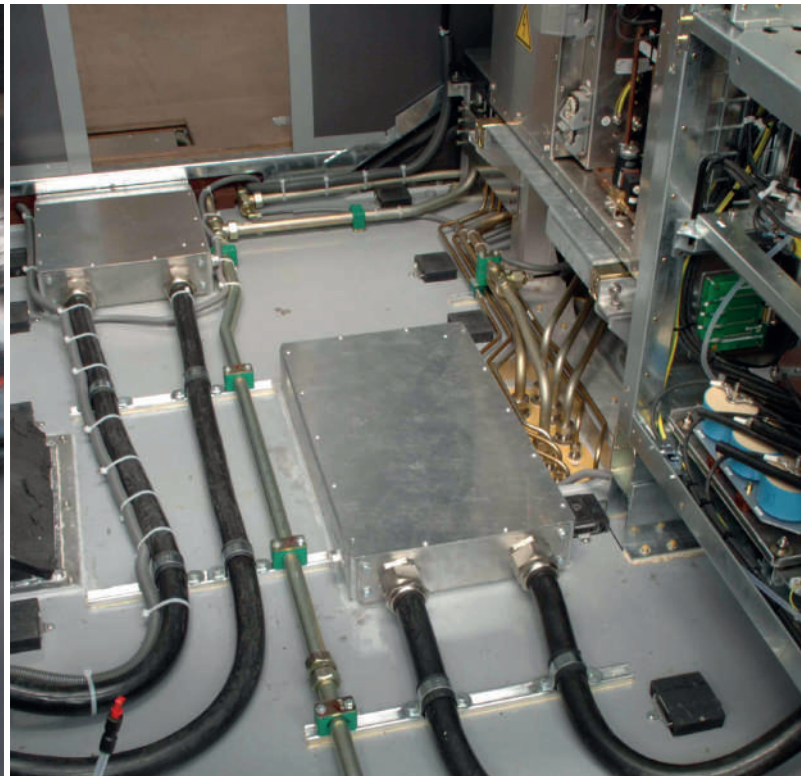

### AGRO Progress® bedenkenlos für Schienenfahrzeuge

AGRO Progress® Kabelverschraubungen aus Metall können bedenkenlos für alle Anwendungen und Anordnungen im Schienenfahrzeugbereich eingesetzt werden. Dies bescheinigt das neue Zertifikat.

Die herausragende Progress® Kompressionstechnik sorgt für eine hohe Dichtigkeit und eine äusserst kabelschonende Zugentlastung auch bei dynamischen Anwendungen. Standard- und EMV-Kabelverschraubungen mit dem entsprechenden Zubehör bilden das Basissortiment für nahezu alle Anwendungen. AGRO fertigt bei Bedarf auch zertifizierte Lösungen gemäss Anforderungen der Kunden.

### Beste Resultate bei Prüfungen nach EN 45545-2 (Komponenten)

Die Dichteinsätze der Progress® Kabelverschraubung sind aus einem speziellen TPE gefertigt und sind im anspruchsvollsten **Hazard Level 3** zertifiziert.

Die geforderten Werte für Hazard Level 3 wurden sowohl im Aussen- als auch im Innenbereich deutlich übertroffen:

### AGRO Progress® - the ideal solution for rolling stock

AGRO Progress® metal cable glands can be used with confidence for any rolling stock application, in any arrangement, as has been recently certified.

The outstanding Progress® compression technology ensures tight seals and offers cables exceptional damage-preventing strain relief, even in dynamic applications. A comprehensive range of standard and EMC cable glands and accessories offers a solution for almost any application. Where the need arises, AGRO also delivers certified solutions according to customer requirements.

### Best results in testing according to EN 45545-2 (Components)

The seal inserts of Progress® cable glands are made from a special TPE and certified to the demanding **Hazard Level 3**.

The stipulated values for Hazard Level 3 were exceeded, for both indoor and outdoor areas:

	Normwert für HL 3 aussen Requirement for HL 3 outdoor	Normwert für HL 3 innen Requirement for HL 3 indoor	AGRO Resultat AGRO result
Sauerstoffindex   Oxygen index	Min. 32%	Min. 32%	<b>39%</b>
Rauchgasdichte Ds   Smoke gas density Ds	Max. 300	Max. 150	<b>110</b>
Toxizität CIT   Toxicity CIT	Max. 1.5	Max. 0.75	<b>0.16</b>

Kabelverschraubungen zertifiziert für den Einsatz in Schienenfahrzeugen  
Cable glands certified for rolling stock applications



**Material:** Messing vernickelt  
**Material Dichteinsatz:** Spezial AGRO TPE  
**Farbe Dichteinsatz:** Hellgrau RAL 7035  
**Gewinde:** M12 bis M63  
Pg 7 bis Pg48

**Einsatztemperatur:** -50°C / +105°C

**Schutzart:** IP 68 / IP 69 K  
**Weitere Normen:** EN 62444

**Material:** Nickel-plated brass  
**Material sealing insert:** Special AGRO TPE  
**Colour sealing insert:** Light grey RAL 7035  
**Threads:** M12 to M63  
Pg 7 to Pg48M12 M63  
Pg 7 Pg48

**Temperature range:** -50°C / +105°C-50°C / +105°C

**Protection class:** IP 68 / IP 69 K  
**Further standards:** EN 62444





# AGRO Kabelverschraubungen sind zertifiziert nach EN 45545-3

## AGRO cable glands are certified according to EN 45545-3

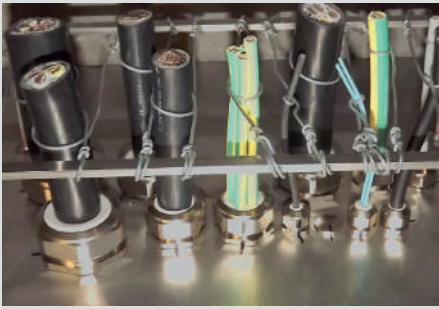

Ausgangssituation | Initial situation



Nach 10 Minuten | After 10 minutes



Nach 20 Minuten | After 20 minutes



Nach 30 Minuten | After 30 minutes



Nach 35 Minuten | After 35 minutes

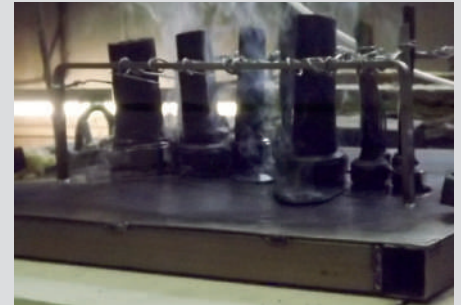

Nach 44 Minuten | After 44 minutes

### Vorgaben der EN 45545-3 übertroffen!

Die EN 45545-3 definiert die Anforderungen an den Feuerwiderstand für Feuerschutzabschlüsse. Ziel der EN 45545-3 ist es, die Brandausbreitung durch Materialanforderungen zu begrenzen. Wenn Kabel durch Feuerschutzabschlüsse geführt werden, gelten diese Anforderungen auch für Kabelverschraubungen.

Um festzustellen, ob der geforderte Feuerwiderstand erreicht wird, werden die Komponenten in einem Prüfofen in Hinblick auf die Kriterien Raumabschluss, Wärmedämmung und Strahlenemission geprüft.

AGRO Progress® Kabelverschraubungen aus Metall übertreffen die Vorgaben der EN 45545-3 bei weitem und erreichen die sehr hohe Feuerwiderstandsklasse E30. Dies bedeutet, dass die Dichteinsätze mindestens 30 Minuten lang dicht sind und einen Flammenübertrag auf die dem Feuer abgewandte Seite verhindern. Es bilden sich keine Spalten. Sie können aus brandschutztechnischer Sicht bedenkenlos in allen Schienenfahrzeugen eingesetzt werden.

### Exceeding the demands of EN 45545-3!

EN 45545-3 defines the requirements for fire resistance of fire barriers. The aim of EN 45545-3 is to limit fire spread by specifying the performance of materials and components. If cables are routed through fire barriers, the requirements apply also to the cable glands used.

In order to establish whether or not the required fire resistance is achieved, components are tested in a testing furnace with respect to requirements for fire barrier, thermal insulation and radiation emission.

AGRO Progress® metal cable glands easily exceed the requirements of EN 45545-3 and satisfy the very high demands of fire resistance class E30. This means that the seal inserts remain impervious and prevent the spread of fire through the gland for at least 30 minutes. They do not crack or fissure. From a fire protection perspective, they can be used without hesitation in all railway vehicles.



EN 45545-3  
E30

	Einbaulage vertikal Vertical installation	Einbaulage horizontal Horizontal installation	Klassierung Classification
AGRO Resultat AGRO result	44 min	41 min	E30

Der Brandversuch wurde durchgeführt mit AGRO Progress® Kabelverschraubungen Messing vernickelt und Dichteinsätzen aus Spezial AGRO TPE, Größen M16 bis M50, sowie mit Multi-Kabelverschraubungen und Verschlusschrauben.

Fire testing was carried out using AGRO Progress® nickel-plated brass cable glands and seal inserts of Special AGRO TPE, sizes M16 to M50, and with multicable glands and locking screws.



# Sonderlösung Kabelverschraubung Knabberschutz

## Rodent-proof special cable gland solution



© ABB

### Wenn Nager zum Sicherheitsrisiko werden

Manch einer kennt das Phänomen aus eigener Erfahrung: das Auto will sich am Morgen nicht starten lassen, und der Reparaturdienst stellt fest, dass Gummiteile von Mardern weggefressen worden sind.

Marder, Nager und Vögel lieben Gummi. Die Konsistenz und der Duft von Gummi zieht Kleintiere an und sie knabbern ihn an. Frei geknabberte Kabel führen zu Kurzschlüssen und Funktionstörungen. Wenn ummantelte Kabel in einem natürlichen Umfeld eingesetzt werden, so muss mit einem Nagerschaden gerechnet werden und entsprechende Vorsichtsmaßnahmen sind sinnvoll.

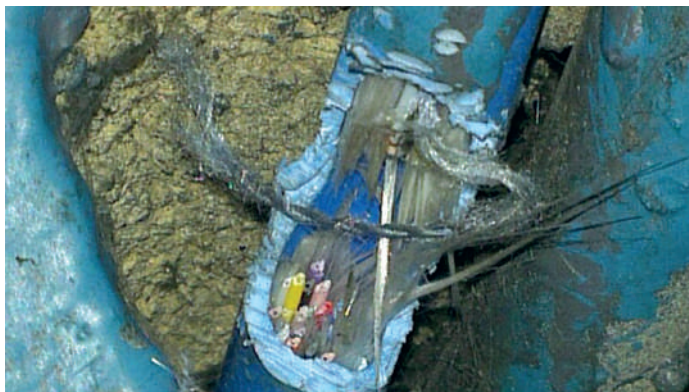

Nagerschaden an Kabel / Rodent damage to a cable

ABB baut Schaltanlagen, die in der ganzen Welt unter unterschiedlichsten Umweltbedingungen eingesetzt werden.

Möglichen Schäden durch Nager wird standardmässig vorgebeugt, indem die Kabel, welche Generatorschutzschalter und Steuer-schrank verbinden, in einem mit Polyurethan ummantelten flüssigkeitsdichten Schlauch mit Stahlwendel geführt werden. Zur IP68 dichten Einführung der im Schlauch geführten Kabel entwickelte AGRO in Zusammenarbeit mit ABB eine individualisierte Lösung, welche eine feuchtigkeitsdichte Verbindung von Schlauch- und Kabelverschraubung sowie einen sicheren EMV Abgriff ermöglicht. Mit dieser Lösung werden zwei Probleme auf einmal gelöst: die Kabelführung und -Einführung ist feuchtigkeitsdicht und vor Nager geschützt.

### When rodents become a safety risk

Many of us know the phenomenon from personal experience: the car just won't start in the morning and the mechanic finds that rubber parts have been gnawed away by martens.

Martens, rodents and also birds love rubber. Small animals seem to be drawn to rubber by its consistency or its scent, and nibble away at it. What is annoying in a private situation can present a serious safety risk in the case of industrial plant and equipment: damaged cables can result in short circuits and loss of functionality. If shrouded cables are to be used in a natural setting, the risk of rodent damage should be recognised and appropriate precautions taken.

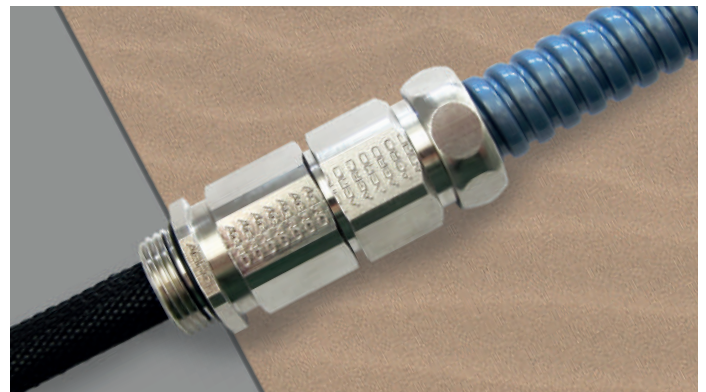

Nager sicherer Kabelschutz mit / Progress® EMV Serie 85 / Rodent proof cable protection

ABB manufactures gas insulated switchgear that is used all around the world in the most varying environments.

Possible damage by rodents is prevented, as standard, by the use of a polyurethanesheathed, liquid-tight conduit with a steel coil to protect cables connecting circuit breakers and control cabinets. For the IP68-compliant entry of the cable into the conduit, AGRO developed, in cooperation with ABB, an individualised solution which facilitates a liquid-tight connection of conduit and cable and a reliable EMC tap. This solution solves two problems at once: the cable route, and in particular the entry point of the cable into the conduit, are liquidtight, and the cable is also protected from rodents.





### Die Ausgangslage

Das Sicherheitsdispositiv im Gotthardtunnel ist hoch und sieht die permanente Überwachung der zirkulierenden Züge vor. In relativ kurzen Abständen überprüfen so genannte Achszählgeräte die Vollständigkeit des Zuges. Die Geräte sind den rauen Bedingungen im Tunnel sowie Steinschlag ausgesetzt

### Die Anforderungen

Die stromführenden Kabel sollten mit einem schlagfesten Schlauch vor Schotterschlag geschützt werden. Die Verbindung Kabelverschraubung-Schlauch sollte auf möglichst einfache Weise erfolgen.



Progress® mit Schlauchanschluss / Progress® with hose connection

### Die Lösung von AGRO

Grundlage des Lösungsansatzes bildet eine Standard Progress® Kabelverschraubung. Sie wird ergänzt durch eine kundenspezifische Schlauchanschluss-hülse für die einfache und ausreißfeste Aufnahme für den Schutzschlauch.

Eine Verschlusskappe verschliesst die Kabeleinführung mit einer Dichtigkeit von IP 68, solange diese unbelegt bleibt.

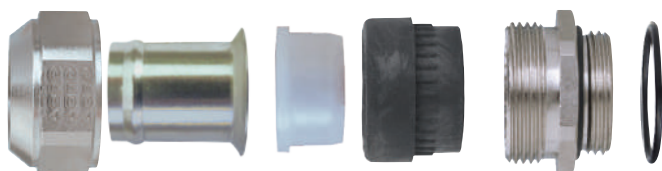

Technische Änderungen vorbehalten. | Technical details are subject to change.

### The situation

Safety arrangements in the Gotthard tunnel are extensive and provide for permanent monitoring of trains as they pass through. At relatively short intervals, so-called axle counters check the completeness of the train. The equipment is exposed to rough tunnel conditions, including stone impacts.

### The requirements

The power cables should be protected from stone ballast by an impact-resistant conduit. The connection between cable gland and conduit should be as simple as possible.



Achszähler / Axle counter

### The AGRO solution

The solution is based on a standard Progress® cable gland. It is supplemented by a customised conduit connection sleeve for a simple and tension-resistant fitting for the protective conduit.

When not in use, a cap seals the cable entry to IP 68 requirements.





Glühdrahttest bei 850°C  
Glow wire test at 850°C



Druckprüfung zur Ermittlung des IP Schutzes  
Pressure test for the determination of the degree of IP protection

Das Arbeiten und Leben mit Strom birgt Risiken. Normen und staatliche Richtlinien wollen diese Risiken minimieren und Installateuren, Monteuren und zu guter Letzt auch dem Endnutzer mehr Sicherheit bieten.

**Geprüfte und zertifizierte Produkte** geben dem Installateur Sicherheit bei der Montage und die Gewissheit, dass das Produkt seine Funktion über viele Jahre erfüllen wird. Ausserdem bleibt die abschliessende Haftung bei einem durch Electrosuisse zertifizierten Produkt im Schadenfall beim Hersteller der Komponente.

AGRO liess ihr Labor von Electrosuisse überprüfen, weil sie das **TMP-Zertifikat** anstrebte. TMP bedeutet: Testing at manufacturer premises. Die offizielle Zertifizierungsstelle stellt fest: „Das AGRO-Prüflabor erfüllt die relevanten Kriterien für die Anerkennung von Prüfberichten nach OD ECS 37 und sie entsprechen den Anforderungen von ISO/IEC 17025:2005 (Allgemeine Anforderungen an die Kompetenz von Prüf- und Kalibrierlaboratorien).“ Im Klartext heisst dies: „AGRO AG verfügt über das nötige normative Wissen, um Produkte schnell und sicher zu prüfen. Die Prüfberichte des Labors sind die Grundlage für die Zertifizierung eines Produkts durch Electrosuisse.“

Was nützt das dem Kunden aus der Elektrobranche, Maschinen und Automatisierungsindustrie?

Working and living with electricity inevitably involves risks. Standards and government directives have the goal of minimising these risks and offering additional safety to electricians, fitters and most of all the end user.

**Products which have been tested and certified** provide the fitter with security during installation and assembly, and this testing also provides the certainty that the product will perform its function for many years. Furthermore, the final liability for damage or injury caused by a product certified by Electrosuisse lies with the component manufacturer.

AGRO had its laboratory examined by Electrosuisse because it wanted to receive the **TMP (Testing at Manufacturers' Premises) certificate**. The official certification office established that: "The AGRO test laboratory meets the relevant criteria for recognition of test reports according to OD ECS 37, and they meet the requirements of ISO/IEC 17025:2005 (General requirements for the competence of testing and calibration laboratories)." In simple terms, this means that "AGRO AG has the necessary knowledge of standards and test procedures which allow it to test products quickly and safely. The laboratory's test reports are the basis for having Electrosuisse certify a product." What value does this have for customers from the electrical or machinery sectors or automation industry?



Video Prüflabor



Video test laboratory



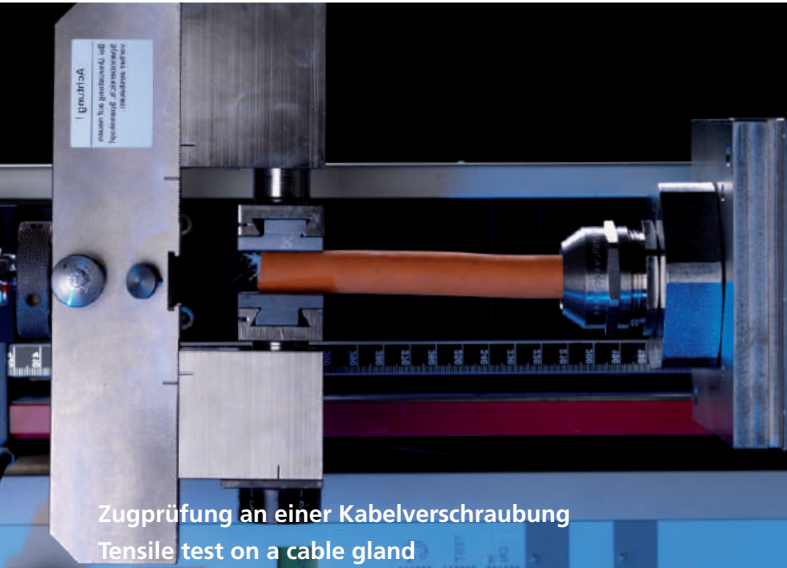

### Im Mittelpunkt der Prüfung

Das erfolgreiche Bestehen der Prüfung durch Electrosuisse gibt dem Konsumenten die Gewähr, dass der Hersteller eines Produktes über das notwendige normative Wissen verfügt und dass die Prüfeinrichtungen für die Durchführung von Prüfungen nach offiziellen Standards geeignet sind. Geprüft wurden unter anderem die IP-Druckprüfanlage (Schutzart IPX8 bis 10 MPa (100 bar) und die Zugprüfmaschinen bis 2.5 kN (250 kg) für das Prüfen von Kabelverschraubungen, Steckdeckeln, Lampendübeln und anderen Komponenten. Ebenso der Klimaschrank für das Durchführen von Wärmealterungen, die Einrichtung für die Schlagprüfungen, mit der die Widerstandskategorie von Kabelverschraubungen ermittelt wird, und das Testgerät, mit dem die Glühdrahtfestigkeit an Bauteilen nach IEC (650°C / 850°C) geprüft wird.

Alles in allem kommen die Electrosuisse-Experten zu folgendem Schluss: „Die Produkte von AGRO halten, was das Unternehmen verspricht“.

### At the focus of testing

By successfully passing the Electrosuisse tests, the manufacturer of a product gives the consumer the assurance that it has the necessary knowledge of standards and test procedures, and that the set-ups for conducting the tests have been judged as being suitable according to official standards. Among the test set-ups evaluated were the ingress protection pressure test system (Protection Class IP X8 up to 10 MPa (100 bar) and tensile testing machines up to 2.5 kN (250 kg) for testing cable glands, socket lids, lamp anchors and other components. Also examined were an environmental chamber for conducting accelerated thermal aging, set-ups for impact tests with which the ruggedness category of cable glands is determined, and the equipment with which the glow wire resistance of components is tested according to IEC (650°C / 850°C). All things considered, the Electrosuisse experts came to the following conclusion: "AGRO products perform just as the company promises."



Wir verfügen ebenfalls über eigens konstruierte Prüfeinrichtungen, welche es uns erlauben, **nach der amerikanischen UL514B zu prüfen**. Dies beinhaltet den Oil-Spray, Flexing und pull-out Test sowie die Alterungsprüfung.

Neu können wir im Witness-Verfahren auch Prüfungen (Zertifizierungen) für Kabelverschraubungen, welche für den Einsatz in Explosionsgefährdeten Bereichen zugelassen sind, nach IEC/EN 60079-0 und IEC/EN 60079-1, Zündschutzart „e“ und „d“ durchführen.

All dies erlaubt uns bereits in der Entwicklungsphase die Normvorschriften zu überprüfen und in die weitere Entwicklung mit einfließen zu lassen.

Darüber hinaus sind wir in den wichtigsten nationale Normengremien vertreten, damit wir aktiv die zukünftigen Normen mit gestalten können.

AGRO has expanded its test laboratory with additional test set-ups and can now conduct oil-spray, flexing and pull-out tests as well as accelerated aging tests in accordance with the requirements of the **American UL 514B standard**.

We are able to conduct witness tests on cable glands for use in explosive atmospheres according to IEC/EN 60079-0 for ignition protection type "e" and IEC/EN 50079-1 for ignition protection type "d".

The ability to conduct in-house tests allows us to verify the non-conformity of new products early in the development stage. The development process can thus be faster and more efficient.

AGRO is represented in the most important national standardisation bodies and takes an active role in the design of future standards.

# Brandschutzklassen

## List of fire protection classes

Brandschutzklassen nach UL 94		Fire Protection Classes acc. to UL 94	
<b>HB</b>	Langsames Brennen einer horizontal eingespannten Probe. Selbstverlöschend oder mit folgender Brenngeschwindigkeit bei Dicke < 3 mm; Rate < 75 mm/min [HB75] bei Dicke 3 ... 13 mm; Rate < 45 mm/min [HB40]	Slow burning on a horizontal specimen. Stop burning or burning speed for thickness < 3 mm; rate < 75 mm/min [HB75] for thickness 3 ... 13 mm; rate 45 mm/min [HB40]	
<b>V2</b>	Selbstverlöschend bei einer vertikalen Probe innerhalb von 30 Sekunden. Brennendes Abtropfen von Kunststoffschmelze zulässig.	Burning stop within 30 seconds on a vertical specimen. Drips of flaming particles are allowed.	
<b>V1</b>	Selbstverlöschend bei einer vertikalen Probe innerhalb von 30 Sekunden. Kein brennendes Abtropfen von Kunststoffschmelze zulässig.	Burning stop within 30 seconds on a vertical specimen. Drips of particles are allowed as long as they are not inflamed.	
<b>V0</b>	Selbstverlöschend bei einer vertikalen Probe innerhalb von 10 Sekunden. Kein brennendes Abtropfen von Kunststoffschmelze zulässig.	Burning stop within 10 seconds on a vertical specimen. Drips of particles are allowed as long as they are not inflamed.	

## Zuordnungstabelle Schlauch - Schlauchverschraubung

### Assignment table Conduit - Conduit gland







Zuordnungstabelle Schlauchdimensionen zu Gewindegrößen von Verschraubungen		Chart assigning conduit dimension to corresponding thread sizes of glands	
Nenngrösse AD Schlauchgrösse aussen Ø <i>Nominal size AD</i> Exterior dimension Ø	Nennweite Mitbewerberangabe <i>Nominal size</i> Indications of concurrence <i>Nominal size AD</i> Exterior dimension Ø	Pg-Gewinde DIN 40430 <i>Pg-thread</i> DIN 40430	Metrische Gewinde EN 60423 <i>Nominal size</i> EN 60423
10	07	Pg 7 (9, 11, 13)	M 10x1.0 M 12x1.5
13	10	Pg 9 (7, 11, 13)	M 12x1.5 M 16x1.5
15.8	12	Pg 11 (13, 16)	M 16x1.5 M 20x1.5
18.5	14	Pg 13 (16)	
21.2	17	Pg 16 (13)	M 20x1.5 M 25x1.5
28.5	23	Pg 21 (16)	M 25x1.5 M 32x1.5
34.5	29	Pg 29	M 32x1.5 M 40x1.5
42.5	36	Pg 36	M 40x1.5 M 50x1.5
54.5	48	Pg 48	M 50x1.5 M 63x1.5

**1. Ziffer:**

Schutzgrad für Berührungs- und Fremdkörperschutz

**1st figure:**

Degree of protection against touching and foreign matters









IP Prüfungen / Specifications	
<b>IP 0x</b>	<b>Kein Schutz</b> <b>No protection</b>
<b>IP 1x</b> 	Schutz gegen Eindringen von festen Fremdkörpern grösser als 50 mm (unbeabsichtigtes Berühren mit der Hand) Protection against penetration by solid foreign matters larger than 50 mm (accidental touching by hand)
<b>IP 2x</b> 	Schutz gegen Eindringen von festen Fremdkörpern grösser als 12 mm (unbeabsichtigtes Berühren mit den Fingern) Protection against penetration by solid foreign matters larger than 12 mm (touching with fingers)
<b>IP 3x</b> 	Schutz gegen Eindringen von festen Fremdkörpern grösser als 2.5 mm (unbeabsichtigtes Berühren mit Werkzeugen, Drähten usw., dicker als 2.5mm) Protection against penetration by solid foreign matters larger than 2.5 mm (touching with tools, wires etc. larger than 2.5 mm)
<b>IP 4x</b> 	Schutz gegen Eindringen von festen Fremdkörpern grösser als 1 mm (Berühren mit Werkzeugen, Drähten usw., dicker als 1 mm) Protection against penetration by solid foreign matters larger than 1 mm (touching with tools, wires etc. larger than 1 mm)
<b>IP 5x</b> 	Vollständiger Schutz gegen Berühren, Schutz gegen schädliche Staubablagerung – Eindringen von Staub wird nicht vollkommen verhindert Complete protection from being touched. Protection from harmful dust deposits - dust penetration is not completely prevented
<b>IP 6x</b> 	Vollständiger Schutz gegen Berühren, Schutz gegen Eindringen von Staub Complete protection from being touched. Protection against penetration by dust..

**2. Ziffer:**

Schutzgrad für Wasserschutz

**2nd figure:**

Degree of protection against water

IP Prüfungen / Specifications	
<b>IP x0</b>	<b>Kein Schutz</b> <b>No protection</b>
<b>IP x1</b> 	Senkrecht fallende Tropfen dürfen keine schädigende Wirkung haben Dripping water (vertically falling drops) shall have no harmful effect
<b>IP x2</b> 	Senkrecht fallende Tropfen dürfen keine schädigende Wirkung haben, wenn das Gehäuse um einen Winkel von bis zu 15° beiderseits der Senkrechten geneigt ist Vertically dripping water shall have no harmful effect when the enclosure is tilted at an angle up to 15° from its normal position
<b>IP x3</b> 	Wasser, das in einem Winkel bis zu 60° beiderseits der Senkrechten gesprüht wird, darf keine schädliche Wirkung haben Water falling as a spray at any angle up to 60° from the vertical shall have no harmful effect
<b>IP x4</b> 	Wasser, das aus jeder Richtung gegen das Gehäuse spritzt, darf keine schädliche Wirkung haben Water splashing against the enclosure from any direction shall have no harmful effect
<b>IP x5</b> 	Wasser, das aus jeder Richtung als Strahl gegen das Gehäuse gerichtet ist, darf keine schädliche Wirkung haben Water projected by a nozzle against enclosure from any direction shall have no harmful effects
<b>IP x6</b> 	Wasser, das aus jeder Richtung als starker Strahl gegen das Gehäuse spritzt, darf keine schädliche Wirkung haben Water projected in powerful jets against the enclosure from any direction shall have no harmful effects
<b>IP x7</b> 	Wasser darf nicht in einer Menge eintreten, die schädliche Wirkungen verursacht, wenn das Gehäuse unter genormten Druck- und Zeitbedingungen zeitweilig in Wasser getaucht ist Ingress of water in harmful quantity shall not be possible when the enclosure is immersed in water under defined conditions of pressure and time
<b>IP x8</b> 	Wasser darf nicht in einer Menge eintreten, die schädliche Wirkungen verursacht, wenn das Gehäuse dauernd unter Wasser getaucht ist unter Bedingungen, die zwischen Hersteller und Anwender vereinbart werden müssen; Die Bedingungen müssen jedoch schwieriger sein als für Kennziffer 7 The equipment is suitable for continuous immersion in water under conditions which shall be specified by the manufacturer The requirements must be more demanding than the ones of code number 7
<b>IP x9</b>	Schutz gegen Eindringen von Wasser unter Hochdruck (80-100 bar) mit einer Temperatur bis 80°C (Dampfstrahlreinigung) Protection against the penetration of water during high-pressure (80 - 100 bars), high-temperature wash-down applications (80°C)

1  
2  
3  
4  
5  
6  
7  
8  
9  
10  
11  
12



# Fachgerechtes Trennen

## Professional cutting

### Trennen und Ablängen von Schläuchen aller Art mit einer Bandsäge

Cutting and trimming of all types of conduit with a band saw



Schlauch im rechten Winkel zum Sägeblatt ansetzen  
Position conduit at right angles to band saw



Schlauch mit wenig Druck durchsägen  
Cut conduit with low pressure on the conduit



Sauberer Schnitt und gebrauchsfertige Schlauchenden  
Conduit ends are clean and ready for use

### Trennen von Schläuchen mit Metallumflechtung mit einer Bandsäge

Cutting of metal braided conduits with a band saw



Trennstelle ca. 2-3x mit Metall-Klebeband umwickeln  
Bind conduit with metal adhesive tape at the cutting position 2 or 3 times



Im rechten Winkel zum Sägeblatt mit geringem Druck durchtrennen  
Position conduit at right angle to the band saw and carefully cut through the conduit



Saubere Trennung ohne Fasern durch die Umwicklung mit Metall-Klebeband  
Conduit ends are clean without splaying, due to adhesive tape binding

Für einen Planschnitt empfehlen wir folgenden Werkzeugeinsatz: Feingezahnte Bandsäge, 4-5 mm breit, 0.6 - 0.8 mm dick, 24 Zähne, mit hoher Schnittgeschwindigkeit.

For a map interface, we recommend the following tool use: Band saw, 4 to 5mm wide, 0.6 to 0.8 mm thick, 24 teeth, used at a high cutting speed.

### Trennen von umflochtenen Schutzschläuchen mit einer Trennscheibe

Cutting of protective braided conduits with cutting disc



Schlauch im rechten Winkel unter der Trennscheibe fixieren  
Position conduit below cutting disc (90°)



Mit geringem Druck durchtrennen  
Enden versäubern  
Cut through the conduit with low pressure clean ends

### Trennen und Ablängen von Metall-Schutzschläuchen mit einer Mini-Kreissäge

#### Cutting and trimming of protective metal conduits with a small disc saw



Trennschnitt in Längsrichtung des Schlauches über 1 bis 2 Schlauchgänge  
Cut longitudinally across 2 hose covering segments



Schlauch auseinanderdehnen  
Unscrew the coils

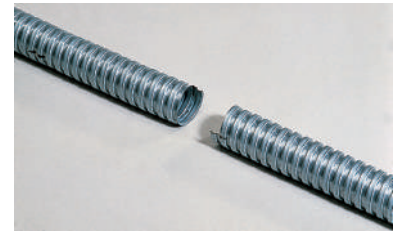

Das Ergebnis sind fachgerechte Schlauchenden  
The result is a skilled parting

Wir empfehlen folgenden Werkzeugeinsatz: Kreissäge Hartmetallblatt ca. 12 bis 15 mm Ø, ca. 25 Zähne bei Messingschnitt, ca. 50 Zähne bei Stahlschnitt, ca. 40'000 U/min. Antrieb Druckluft oder elektrisch.

We recommend the following tool use: 12 to 15 mm diameter, with carbide tipped teeth. Number of teeth: 25 on copper disc; 50 on steel disc. Disc speed: Approx. 40.000 r.p.m. Drive: Pneumatic or electric. Disc saw and accessories available on request.

### Manuelles Trennen

#### Metallschutzschläuche



Metallschlauch kräftig nach innen verjüngend aufdrehen (eine Hand nach rechts, die andere Hand nach links drehen)

Compress metal conduit between both hands and unwind with contra-rotating hand motions

### Manual cutting

#### Metal protective conduit

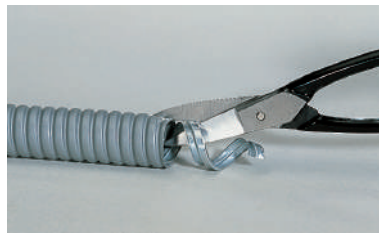

Mit Feinblehschere trennen, 1 bis 2 Schlauchgänge ausheben, quer zum Profil abschneiden, mit einer Blehschere die überstehenden Teile sauber abschneiden.

Cut off with snips. Uncoil one or two segments and cut off. Press in the ends and snip off the protruding corners.

### Metallschutzschläuche mit Kunststoffummantelung



Kunststoffummantelung durchschneiden  
Cut through the synthetic sheathing

### Metal protective conduits with synthetic sheathing



Schlauch knicken und Wendel mit der Zange durchtrennen  
Bend the conduit and cut through the helix

# Chemische Beständigkeit Kunststoffe

## Chemical resistance synthetic materials

- **beständig**  
resistant
- o **bedingt beständig**  
conditionally resistant
- **nicht beständig**  
not resistant

Reagens / Reagens	Konzentration % Concentration %	bei +C° at temp. +C°	PA 6	PA 12	PU	PVC	SI	TPE	NBR
			Polyamid Polyamide	Polyamid Polyamide	Polyurethan Polyurethane	Weich-PVC Soft-PVC	Silikon Silicone	Thermo-plastisches Elastomer Thermoplastic Elastomer	Nitril-Butadienkautschuk Nitril-Butadienrubber
Abgase, kohlenstoffdioxidhaltig Waste gas, containing carbon dioxide	jede any	60	•	•		-	•		•
Abgase, SO <sub>2</sub> -haltig Waste gas, containing SO <sub>2</sub>	gering low	60	•	•		•	o		•
Acetaldehyd wässrig Acetaldehyde, hydrous	40	20	o	•		-	o		-
Aceton Acetone	100	20	•	•	-	-	o	o	-
Acrylsäure Acrylic acid	100	>30	-	-		-	o	-	o
Alaune, wässrig Alum, hydrous	verdünnt dilute		o	•		-			•
Allylalkohol Allyl alcohol	96	20	o	•		•	•	•	•
Aluminiumchlorid, wässrig Aluminium chloride, hydrous	verdünnt dilute	40	o	o	•	•	o/-	•	20°C •
Aluminiumsulfat, wässrig Aluminium sulphate, hydrous	verdünnt dilute	40	•	•		•	•	•	20°C •
Ameisensäure, wässrig Formic acid, hydrous	10	20	-	-		o	o	•	o
Ammoniak, wässrig Ammonia solution, hydrous	10	20	•	•	•	o	o	o	•
Ammoniumchlorid, wässrig Ammonium chloride, hydrous	10	20	•	•	3% •	•	o	•	•
Ammoniumnitrat, wässrig Ammonium nitrate, hydrous	verdünnt dilute	40	•	•		•	•		20°C •
Ammoniumsulfat, wässrig Ammonium sulphate, hydrous	verdünnt dilute	40	•	•		-	•	•	•
Anilin, rein Aniline, pure	100	20	o	o	o	-	o	o	-
Benzaldehyd, wässrig Benzaldehyde, hydrous	gesättigt saturated	20	rein pure o	rein pure o		-	-	o	-
Benzin Benzine	100	20	•	•	•	20°C •	-	o	•
Benzoessäure, wässrig Benzoic acid, hydrous	jede any	40	20% o	20% o		-	-		•
Benzol Benzole	100	20	•	•	-	•	-	-	•
Bleichlauge Bleaching liquor		20	-	-	•	•	o		-
Bohröl Drilling oil			•	•		20°C •	o		•
Borax, wässrig Borax, hydrous	verdünnt dilute	40	•	•		-	o	•	20°C o
Boraxsäure, wässrig Boric acid, hydrous	3	20	o	o	•	o	o	•	•
Brom, flüssig Bromine, liquid	100	20	-	-	-	-	-	-	-
Bromwasserstoffsäure, wässrig Hydrobromic acid, hydrous	bis 10 up to 10	40	-	-		-	o		-

# Chemische Beständigkeit Kunststoffe

## Chemical resistance synthetic materials

- **beständig**  
resistant
- **bedingt beständig**  
conditionally resistant
- **nicht beständig**  
not resistant

Reagens / Reagens	Konzentration % Concentration %	bei +C° at temp. +C°	Polyamid Polyamide		PU	PVC	SI	TPE	NBR	
			PA 6	PA 12						
Butandiol, wässrig Butanediol, hydrous	bis 10 up to 10	20	rein pure •	rein pure •		•	◦		-	
Butanol Butanol	bis 100 up to 100	20	•	•	-	-	◦		•	
Butylacetat Butylacetate	100	20	•	•	-	◦	◦		-	
Calciumchlorid, wässrig Calcium chloride, hydrous	gesättigt saturated	40	•	•		•	•	•	20°C •	
Chlor, gasförmig Chlorine, gas	jede any	20	-	-	-	-	-	◦	-	
Chromalaun, wässrig Alum, hydrous	verdünnt dilute	40				•			20°C •	
Cyclohexanol Cyclohexanol	-	20	•	•	◦	•	◦		-	
Diesekraftstoff Diesel fuel		85	•	•	20°C •	-	◦		•	
Eisenchlorid, wässrig, neutral Ferrous chloride, hydrous, indiff.	10	20	•	•	40°C ◦		•	•	•	
Eisessig (Essigsäure, konz.) Acetic acid pure	100	20	◦	◦	-	•	◦	◦	-	
Essigsäure Acetic acid	10	20	◦	•	-	-	◦	•	-	
Ethanol Ethanol	jede any	20	•	•	•	•	•	•	•	
Ethylenchlorid Ethyl dichloride	100	20	◦	◦		•	-		-	
Ethylenoxid Ethylene oxide, liquid	100	20	•	•		-	-	◦	-	
Ethylether Ethyl ether	100	20	•	•	◦	-			◦	
Ferricyankalium, wässrig Ferric cyanide, hydrous	gesättigt saturated	60	◦	◦		-				
Fluor, gasförmig Fluorine, gas	jede any	20	-	-	-	-	-	-	-	
Formaldehyd, wässrig Formaldehyde, hydrous	jede any	20	-	-		•	◦	40% •	-	
Glukose, wässrig Glucose, hydrous	jede any	50				•	•		•	
Harnstoffe, wässrig Urea, hydrous	bis 10 up to 10	40	20°C •	20°C •	3% •	-	•			
Hydraulikflüssigkeit, schwerentflammbar Hydraulic fluid, hardly inflammable		80	•	•		-	-	•	-	
Hydrauliköle H und HL (DIN 51524) Hydraulic oil H and HL (DIN 51524)		100	•	•		-	-		◦	
Hydroxylaminsulfat, wässrig Hydroxylamine sulphate, hydrous	bis 12 up to 12	30	•	•		•			•	
Kalilauge, wässrig Caustic potash solution, hydrous	50	20	•	•	-	•	◦	10% •	◦	
Kaliumbromid, wässrig Potassium bromide, hydrous	jede any	20	10% ◦	10% ◦		-	•	•	•	

# Chemische Beständigkeit Kunststoffe

## Chemical resistance synthetic materials

- **beständig**  
resistant
- **bedingt beständig**  
conditionally resistant
- **nicht beständig**  
not resistant

Reagens / Reagens			PA 6	PA 12	PU	PVC	SI	TPE	NBR
	Konzentration % Concentration %	bei +C° at temp. +C°							
Kaliumchlorid, wässrig Potassium chloride, hydrous	10	20	•	•		•	•	•	•
Kaliumchromat, wässrig Potassium dichromate, hydrous	40	20	5% ○	5% ○		•	100% •	•	•
Kaliumnitrat, wässrig Potassium nitrate, hydrous	jede any	20	10% •	10% •		•	•	10% •	•
Kaliumpermanganat, wässrig Potassium permanganate, hydrous	gesättigt saturated	20	5% -	5% -		○	•		
Kieselfluorwasserstoffsäure, wässrig Hydrosilicofluoric acid, hydrous	bis 30 up to 30	20	-			○	-	○	
Kohlendioxid, trocken Carbon dioxide, dry	100	60	•	•		•	•	○	20°C •
Kohlensäure Carbon dioxide	100	60	•	•	○	○	•	○	20°C •
Kresol, wässrig Cresol, hydrous	jede any	20	-	-		-	○		-
Kühlflüssigkeiten DIN 53521 Cooling liquids DIN 53521		120	○	•		-			
Kupferchlorid, wässrig Copper monochloride, hydrous	gesättigt saturated	20				•	•	•	•
Kupfersulfat, wässrig Copper sulphate, hydrous	gesättigt saturated	60	•	•		•	•	•	20°C •
Magnesiumcarbonat, wässrig Magnesium carbonate, hydrous	gesättigt saturated	100				•	•		
Magnesiumchlorid, wässrig Magnesium chloride, hydrous	gesättigt saturated	20	10% •	10% •		•	•	•	•
Methylalkohol (Methanol) Methanol	100	20	•	•		○	•	•	•
Methylenchlorid Methylene chloride	100	20	○	○		-	-	○	
Milchsäure, wässrig Lactic acid, hydrous	bis 90 up to 90	20	10% •	10% •	3% ○	•	•	•	•
Mineralöle Mineral oil			•	•	80°C •	20°C •	○	-	
Natriumchlorat, wässrig Sodium chlorate, hydrous	gesättigt saturated	20	10% ○	10% ○		25% ○	20% •	15% •	
Natronlauge, wässrig Caustic soly lye, hydrous	10	20	•	•	3% ○	•	30% •	50% •	
Nickelchlorid, wässrig Nickel chloride, hydrous	gesättigt saturated	20	10% ○	10% ○		•	•		•
Nickelsulfat, wässrig Nickel sulphate, hydrous	gesättigt saturated	20	10% ○	10% ○		•	•		•
Nitroglycerin Nitro glycerin	verdünnt dilute	20				-			
Öle und Fette Oil and grease		20	•	•		○	○	○	
Ölsäure Oleic acid	-	20	•	•		•	○	-	○
Oxalsäure Oxalic acid	jede any	20	10% ○	10% ○	3% ○	•	•		○



# Chemische Beständigkeit Kunststoffe

## Chemical resistance synthetic materials

- **beständig**  
resistant
- **bedingt beständig**  
conditionally resistant
- **nicht beständig**  
not resistant

Reagens / Reagens	Konzentration % Concentration %	bei +C° at temp. +C°	PA 6	PA 12	PU	PVC	SI	TPE	NBR
			Polyamid Polyamide	Polyamid Polyamide	Polyurethan Polyurethane	Weich-PVC Soft-PVC	Silikon Silicone	Thermo-plastisches Elastomer Thermoplastic Elastomer	Nitril-Butadienkautschuk Nitril-Butadienrubber
Ozon Ozone	rein pure		-	-		◦	•		
Petroleum Kerosine	100	80	•	•		-	◦		
Phosgen, gasförmig Phosgene, gaseous	100	20				-			
Phosphorsäure, wässrig Phosphoric acid, hydrous	verdünnt dilute	20	10% -	10% -	3% ◦	50% •	85% •	85% •	-
Phosphorpentoxid Phosphorus pentoxide	100	20				•			
Quecksilber Mercury	rein pure	20	•	•		◦	•		•
Salpetersäure, wässrig Nitric acid, hydrous	50	20	-	-	20% •	◦	10% ◦	30% ◦	-
Salzsäure, wässrig Hydrochloric acid, hydrous	30	20	20% -	20% -	20% ◦	10% •	10% •	10% •	◦
Schmierfette, Basis Esteröle Lubricating grease, base diester oil		110	◦	•		◦	◦	-	
Schmierfette, Basis Polyphenylester Lubricating grease, base polyphenylester		110	•	•		◦	◦	-	
Schmierfette, Basis Silikonöle Lubricating grease, base silicone oil		110	•	•		◦	◦	-	
Schwefelkohlenstoff Carbon disulphide	100	20	•	•		-	◦		-
Schwefelsäure, wässrig Sulphuric acid, hydrous		20	10% -	10% -	20% -	•	10% •	98% •	-
Seewasser Sea water		20	•	•	•	•	•	•	•
Seifenlösung, wässrig Soap solution, hydrous	jede any	20	•	•	•	•	•	•	•
Tetrachlorkohlenstoff Carbon tetrachloride	100	20	•	◦	-	-	-	-	
Toluol Toluene	100	20	•	•	-	-	-	•	-
Trichlorethylen Trichloroethylene	100	20	◦	◦		-	-	-	
Vinylacetat Vinyl acetate	100	20		-	-	-			
Wasserstoffperoxid Hydrogenperoxide	2	20	-	-	•	•	•	•	•
Xylol Xylene	100	20	•	•		-	-	-	-
Zinkchlorid, wässrig Zinc dichloride, hydrous	verdünnt dilute	60	10% ◦			20% •	•	10% •	20% •
Zinksulfat, wässrig Zinc sulphate, hydrous	verdünnt dilute	60				20% •	•	10% •	20% •
Zinchlorid, wässrig Zinc chloride, hydrous	verdünnt dilute	40				•	◦	10% •	20% •
Zitronensäure Citric acid	bis 10 up to 10	40	20% •	20% •	3% ◦		•	•	

# Masse für Gewinde und Bohrlöcher

## Dimensions of threads and drilled holes

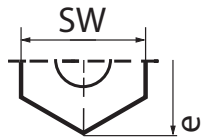



### Ermittlung der Eckmasse „e“

6-Kant:  
 $e = 1.155 \times SW$  (Schlüsselweite)

### Determinatin of the width accross corners „e“

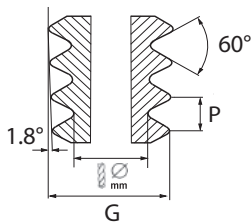
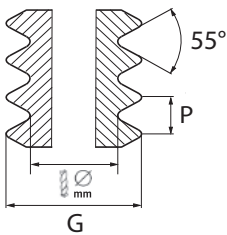
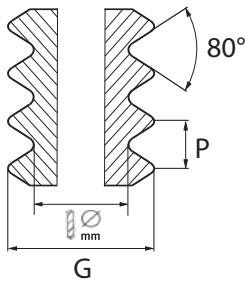
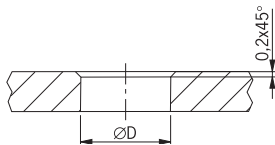
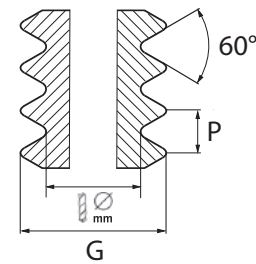
hexagon:  
 $e = 1.155 \times SW$  (opening of the spanner)



	G	Steigung   Pitch P	 mm	ØD mm
<b>Metrisches Gewinde   Metric thread</b>				
M6x1.0 <sup>1)</sup>	6.00	1.00	5.00	6.0
M6x0.75 <sup>2)</sup>	6.00	0.75	5.25	6.0
M8x1.25 <sup>1)</sup>	8.00	1.25	6.75	8.0
M8x1.0 <sup>2)</sup>	8.00	1.00	7.00	8.0
M10x1.5 <sup>1)</sup>	10.00	1.50	8.50	10.0
M10x1.0 <sup>2)</sup>	10.00	1.00	9.00	10.0
M12x1.5	12.00	1.50	10.50	12.0
M16x1.5	16.00	1.50	14.50	16.0
M20x1.5	20.00	1.50	18.50	20.0
M25x1.5	25.00	1.50	23.50	25.0
M32x1.5	32.00	1.50	30.50	32.0
M40x1.5	40.00	1.50	38.50	40.2
M50x1.5	50.00	1.50	48.50	50.2
M63x1.5	63.00	1.50	61.50	63.2
M75x1.5	75.00	1.50	73.50	75.2
M80x1.5	80.00	1.50	78.50	80.2
M85x2.0	85.00	2.00	83.00	85.2
M95x2.0	95.00	2.00	93.00	95.2
M100x3.0	100.00	3.00	97.00	100.2
M105x3.0	105.00	3.00	102.00	105.2
M115x3.0	115.00	3.00	112.00	115.2
<b>Pg - Gewinde   Thread Pg</b>				
Pg 7	12.50	1.27	11.40	12.6
Pg 9	15.20	1.41	14.00	15.3
Pg 11	18.60	1.41	17.25	18.7
Pg 13	20.40	1.41	19.00	20.5
Pg 16	22.50	1.41	21.25	22.6
Pg 21	28.30	1.58	26.75	28.4
Pg 29	37.00	1.58	35.50	37.2
Pg 36	47.00	1.58	45.50	47.2
Pg 42	54.00	1.58	52.50	54.2
Pg 48	59.30	1.58	57.80	59.5
<b>Gasrohr-Gewinde   Gas-pipe thread</b>				
G <sup>1</sup> / <sub>4</sub> "	13.15	1.33	11.60	13.3
G <sup>3</sup> / <sub>8</sub> "	16.66	1.33	15.00	16.8
G <sup>1</sup> / <sub>2</sub> "	20.95	1.81	19.00	21.0
G <sup>5</sup> / <sub>8</sub> "	22.91	1.81	21.00	23.0
G <sup>3</sup> / <sub>4</sub> "	26.44	1.81	24.60	26.5
G1"	33.25	2.30	30.50	33.5
G1 <sup>1</sup> / <sub>4</sub> "	41.91	2.30	39.50	42.2
G1 <sup>1</sup> / <sub>2</sub> "	47.80	2.30	45.00	48.0
G2"	59.61	2.30	57.00	60.0
G2 <sup>1</sup> / <sub>2</sub> "	75.18	2.30	72.50	75.5
G3"	87.88	2.30	84.50	88.0
G4"	113.03	2.30	110.50	113.5
G5"	138.43	2.30	136.00	139.0
<b>NPT-Gewinde   NPT Thread</b>				
NPT <sup>1</sup> / <sub>8</sub> "	10.29	0.94	8.43	
NPT <sup>1</sup> / <sub>7</sub> "	13.72	1.41	11.13	
NPT <sup>3</sup> / <sub>8</sub> "	17.14	1.41	14.27	
NPT <sup>1</sup> / <sub>2</sub> "	21.34	1.81	17.86	
NPT <sup>3</sup> / <sub>4</sub> "	26.67	1.81	23.28	
NPT 1"	33.40	2.20	28.98	
NPT 1 <sup>1</sup> / <sub>4</sub> "	42.16	2.20	37.69	
NPT 1 <sup>1</sup> / <sub>2</sub> "	48.26	2.20	43.66	
NPT 2"	60.32	2.20	55.58	

1) Metrisches Regelgewinde  
 2) Metrisches Gewinde nach EN60423

1) metric coarse pitch thread  
 2) metric thread acc. to EN 60423

# Schlüssel zu Klassifizierungscode EN / IEC 61386 part 23

## Key to classification coding EN / IEC 61386 part 23

1. Stelle / Position Widerstand gegenüber Druckbelastung / Resistance to pressure load	
0	
1	Sehr leicht / Very light 125 N
2	Leicht / Light 320 N
3	Mittel / Medium 750 N
4	Schwer / Heavy 1250 N
5	Sehr schwer / Very heavy 4000 N
2. Stelle / Position Widerstand gegenüber Schlagbeanspruchung / Resistance to impact	
0	
1	Sehr leicht / Very light 0.5 kg
2	Leicht / Light 1.0 kg
3	Mittel 100 mm / Medium 2.0 kg
4	Schwer 300 mm / Heavy 2.0 kg
5	Sehr schwer / Very heavy 6.8 kg
3. Stelle / Position Minimale Dauergebrauchs- und Installationstemperatur / Minimum permanent and installation temperature	
0	
1	(+) 5°C
2	(-) 5°C
3	(-) 15°C
4	(-) 25°C
5	(-) 45°C
4. Stelle / Position Maximale Dauergebrauchs- und Installationstemperatur / Maximum permanent and installation temperature	
0	
1	(+) 60°C
2	(+) 90°C
3	(+) 105°C
4	(+) 120°C
5	(+) 150°C
6	(+) 250°C
7	(+) 400°C
5. Stelle / Position Widerstand gegen Biegung / Resistance to bending	
0	
1	Starr / Rigid
2	Biagsam / Pliable
3	Biagsam / Pliable / zurückbildend / self recovering
4	Flexibel / Flexible
6. Stelle / Position Elektrische Eigenschaften / Electrical characteristics	
0	Nicht erklärt / None declared
1	Mit elektrischen Leiteigenschaften / With electrical conductivity
2	Mit elektrischen Isolationseigenschaften / With electrical insulation properties
3	Mit elektrischen Leit- und Isolationseigenschaften With electrical conductivity and insulation properties
7. Stelle / Position Widerstand gegen Eindringen von Festkörpern / Protection against ingress of solid objects	
0	
1	
2	
3	Gesch. g. Fremdkörper fest, bis Ø 2.5 mm / Protected against solid foreign objects of Ø 2.5 mm
4	Gesch. g. Fremdkörper fest, bis Ø 1.0 mm / Protected against solid foreign objects of Ø 1.0 mm
5	Staubgeschützt / Dust protected
6	Staubdicht / Dust tight

8. Stelle / Position Widerstand gegen Eindringen von Wasser / Protection against ingress of water	
0	Nicht erklärt / None declared
1	Schutz gegen vertikal fallende Wassertropfen / Protected against vertically falling water drops
2	Do. wenn das Rohrsystem bis 15° gekippt ist / Do. when the conduit is tilted up to an angle of 15°
3	Schutz gegenüber Sprühwasser / Protection against spraying water
4	Schutz gegen Spritzwasser / Protection against splashing water
5	Schutz gegen Wasserstrahlen / Protection against water jets
6	Schutz gegen kraftvolle Wasserstrahlen / Protection against powerful water jets
7	Schutz gegen die Auswirkung von zeitweiligem Eintauchen in Wasser / Protection against the effects of temporary immer- sion in water
8	Schutz bei Untertauchen 1.2 m Wassertiefe 1 Stunde / Protection against immersion in water with a depth of 1.2 m during one hour

9. Stelle / Position Korrosionsbeständigkeit von metallenen Elektroinst.-rohr- sys. und Elektroinst.-rohrsys.in Gemischtbauweise / Resistance against corrosion	
0	
1	Geringer Schutz innen und aussen / Low protection inside and outside
2	Mittlerer Schutz innen und aussen / Medium protection in- side and outside
3	Mittlerer Schutz innen hoher Schutz aussen / Medium pro- tection inside high protection outside
4	Hoher Schutz innen und aussen / High protection inside and outside

10. Stelle / Position Zugfestigkeit in Verbindung mit Anschlusssteil / Tensile strength	
0	Nicht erklärt / None declared
1	Sehr leicht / Very light 100 N
2	Leicht / Light 250 N
3	Mittel / Medium 500 N
4	Schwer / Strong 1000 N
5	Sehr schwer / Very strong 2500 N

11. Stelle / Position Widerstand gegen Flammverbreitung / Resistance to flame propagation	
0	
1	Nicht flammverbreitend / Non-flame propagating
2	Flammverbreitend / Flame propagating

12. Stelle / Position Prüfung der Hängelastaufnahmefähigkeit / Suspended load capacity	
0	Nicht erklärt / None declared
1	Sehr leicht / Very light 20 N / 48 h
2	Leicht / Light 30 N / 48 h
3	Mittel / Medium 150 N / 48 h
4	Schwer / Strong 450 N / 48 h
5	Sehr schwer / Very Strong 850 N / 48 h

13. Stelle / Position In Vorbereitung / Under construction	
Brandfolgerscheinung, Toxizität, Corrosivität, Density	

Art.-Nr. Art. No.	Seite Page
<b>01...</b>	
0133.900.002	140
0133.900.003	140
0133.900.004	140
0133.900.005	140
0133.900.007	140
<b>02...</b>	
0206.201.070	26
0206.201.095	26
0206.202.056	26
0206.202.070	26
0206.202.095	26
0220.101.010	86
0220.101.013	86
0220.101.016	86
0220.101.021	86
0220.101.029	86
0220.101.038	86
0220.101.048	86
0232.201.006	20
0232.201.010	20
0232.201.012	20
0232.201.014	20
0232.201.016	20
0232.201.023	20
0232.201.029	20
0232.201.036	20
0232.201.048	20
0233.201.006	18
0233.201.010	18
0233.201.012	18
0233.201.014	18
0233.201.016	18
0233.201.023	18
0233.201.029	18
0233.201.036	18
0233.201.048	18
0233.202.006	18
0233.202.010	18
0233.202.012	18
0233.202.014	18
0233.202.016	18
0233.202.023	18
0233.202.029	18
0233.202.036	18
0233.202.048	18
0233.209.006	20
0233.209.010	20
0233.209.012	20
0233.209.014	20
0233.209.016	20
0233.209.023	20
0233.209.029	20
0233.209.036	20
0233.209.048	20
0233.232.016	19
0233.232.023	19
0233.232.029	19
0233.232.036	19
0233.232.048	19
0236.201.006	22
0236.201.010	22
0236.201.012	22
0236.201.014	22
0236.201.016	22
0236.201.023	22
0236.201.029	22

Art.-Nr. Art. No.	Seite Page
0236.201.036	22
0236.201.048	22
0236.202.006	22
0236.202.010	22
0236.202.012	22
0236.202.014	22
0236.202.016	22
0236.202.023	22
0236.202.029	22
0236.202.036	22
0236.202.048	22
0236.232.016	23
0236.232.023	23
0236.232.029	23
0236.232.036	23
0236.232.048	23
0237.202.006	21
0237.202.010	21
0237.202.012	21
0237.202.014	21
0237.202.016	21
0237.202.023	21
0237.202.029	21
0237.202.036	21
0237.202.048	21
0255.202.110	28
0255.202.112	28
0255.202.116	28
0255.202.123	28
0255.202.129	28
0255.202.136	28
0255.202.148	28
0258.202.006	24
0258.202.010	24
0258.202.012	24
0258.202.016	24
0258.232.016	24
0258.232.023	24
0258.232.029	24
0258.232.036	24
0258.232.048	24
0269.202.006	29
0269.202.008	29
0269.202.010	29
0269.202.014	29
0269.202.019	29
0269.202.020	29
0269.202.024	29
0269.202.026	29
0269.202.032	29
0269.202.043	29
0269.202.061	29
0289.902.006	25
0289.902.010	25
0289.932.012	25
0289.932.016	25
0289.932.023	25
0289.932.029	25
0289.932.036	25
0289.932.048	25
<b>03...</b>	
0308.000.007	69
0308.000.009	69
0308.000.011	69
0308.000.013	69
0308.000.016	69
0308.000.021	69

Art.-Nr. Art. No.	Seite Page
0308.000.029	69
0308.000.036	69
0308.000.048	69
0308.012.013	69
0308.012.016	69
0308.012.019	69
0315.000.009	61
0315.000.011	61
0315.000.013	61
0315.000.016	61
0315.000.021	61
0315.000.029	61
0315.000.036	61
0315.000.048	61
0315.001.020	61
0315.001.025	61
0315.001.032	61
0315.001.040	61
0315.001.050	61
0318.000.016	30
0318.000.020	30
0318.000.025	30
0318.000.032	30
0318.000.040	30
0318.000.050	30
0318.000.063	30
0330.000.007	153
0330.000.009	153
0330.000.011	153
0330.000.013	153
0330.000.016	153
0330.000.021	153
0330.000.029	153
0330.000.036	153
0330.000.048	153
0330.001.010	153
0330.001.012	153
0330.001.016	153
0330.001.020	153
0330.001.025	153
0330.001.032	153
0330.001.040	153
0330.001.050	153
0330.001.063	153
0331.001.007	152
0331.001.009	152
0331.001.011	152
0331.001.013	152
0331.001.016	152
0331.001.021	152
0331.001.029	152
0331.001.036	152
0331.001.048	152
0333.001.010	152
0333.001.012	152
0333.001.016	152
0333.001.020	152
0333.001.025	152
0333.001.032	152
0333.001.040	152
0333.001.050	152
0333.001.063	152
<b>05...</b>	
0541.106.065	74
0541.106.130	74
0541.108.065	74
0541.108.130	74

Art.-Nr. Art. No.	Seite Page
<b>06...</b>	
0601.000.011	137/149
0601.000.016	137/149
0601.000.021	137/149
0601.000.029	137/149
0607.000.016	136
0607.000.020	136
0607.000.021	136
0607.000.025	136
0607.000.032	136
0608.000.016	134
0608.000.020	134
0608.000.021	134
0608.000.025	134
0608.000.032	134
0609.000.016	135
0609.000.020	135
0609.000.021	135
0609.000.025	135
0609.000.032	135
0610.000.011	134
0610.000.013	134
0610.000.016	134
0610.000.021	134
0610.000.029	134
0610.000.036	134
0610.000.048	134
0611.000.011	135
0611.000.013	135
0611.000.016	135
0611.000.021	135
0611.000.029	135
0611.000.036	135
0611.000.048	135
0612.000.011	136
0612.000.013	136
0612.000.016	136
0612.000.021	136
0612.000.029	136
0612.000.036	136
0612.000.048	136
0621.000.051	131
<b>10...</b>	
1010.111.008	78/99
1010.111.011	78/99
1010.111.014	78/99
1010.111.016	78/99
1010.111.018	78/99
1010.111.023	78/99
1010.111.031	78/99
1010.111.040	78/99
1010.111.051	78/99
1010.801.008	78
1010.801.011	78
1010.801.014	78
1010.801.016	78
1010.801.018	78
1010.801.023	78
1010.801.031	78
1010.801.040	78
1010.801.051	78
1080.101.008	79/101
1080.101.012	79/101
1080.101.014	79/101
1080.101.016	79/101
1080.101.018	79/101
1080.101.024	79/101

Art.-Nr. Art. No.	Seite Page
1080.101.031	79/101
1080.101.040	79/101
1080.101.051	79/101
<b>11...</b>	
1165.07	119
1165.09	119
1165.10	118
1165.11	119
1165.12	118
1165.13	119
1165.16	119
1165.17	118
1165.20	118
1165.21	119
1165.25	118
1165.29	119
1165.32	118
1165.36	119
1165.40	118
1165.48	119
1165.50	118
1165.63	118
1165.80.07.060	124
1165.80.07.075	124
1165.80.09.080	124
1165.80.09.100	124
1165.80.10.040	123
1165.80.10.060	123
1165.80.11.085	124
1165.80.11.120	124
1165.80.12.060	123
1165.80.12.075	123
1165.80.13.110	124
1165.80.13.140	124
1165.80.16.110	124
1165.80.16.140	124
1165.80.17.080	123
1165.80.17.100	123
1165.80.20.110	123
1165.80.20.140	123
1165.80.21.160	124
1165.80.21.190	124
1165.80.25.160	123
1165.80.25.190	123
1165.80.29.230	124
1165.80.29.255	124
1165.80.32.210	123
1165.80.32.250	123
1165.80.36.305	124
1165.80.36.350	124
1165.80.40.285	123
1165.80.40.320	123
1165.80.48.430	124
1165.80.48.465	124
1165.80.50.370	123
1165.80.50.410	123
1165.80.63.460	123
1165.80.63.500	123
1165.84.20.15	124
1165.84.25.21	124
1165.84.32.34	124
1165.84.40.34	124
1165.84.50.42	124
1165.84.63.54	124
<b>17...</b>	
1700.07.10	117
1700.09.14	117

Art.-Nr. Art. No.	Seite Page
1700.11.14	117
1700.11.17	117
1700.12.10	115
1700.13.19	117
1700.16.17	117
1700.16.21	117
1700.17.14	115
1700.20.1/2	116/133
1700.20.17	115
1700.20.19	115
1700.20.21	115
1700.20.3/8	116/133
1700.21.27	117
1700.25.21	115
1700.25.27	115
1700.25.3/4	116/133
1700.29.36	117
1700.32.1	116/133
1700.32.27	115
1700.36.45	117
1700.40.36	115
1700.42.45	117
1700.48.56	117
1700.50.45	115
1700.63.56	115
1710.60.07.10	117
1710.60.09.14	117
1710.60.11.14	117
1710.60.11.17	117
1710.60.12.10	115
1710.60.13.19	117
1710.60.16.17	117
1710.60.16.21	117
1710.60.17.14	115/133
1710.60.20.1/2	116/133
1710.60.20.17	115
1710.60.20.19	115
1710.60.20.21	115
1710.60.20.3/8	116/133
1710.60.21.27	117
1710.60.25.21	115
1710.60.25.27	115
1710.60.25.3/4	116/133
1710.60.29.36	117
1710.60.32.1	116/133
1710.60.32.27	115
1710.60.36.45	117
1710.60.40.36	115
1710.60.42.45	117
1710.60.48.56	117
1710.60.50.45	115
1710.60.63.56	115
1710.80.07.060.1	122
1710.80.09.080.1	122
1710.80.09.100.1	122
1710.80.11.085.1	122
1710.80.11.120.1	122
1710.80.12.060.1	120
1710.80.12.060.2	121
1710.80.13.110.1	122
1710.80.13.140.1	122
1710.80.16.110.1	122
1710.80.16.140.1	122
1710.80.17.080.1	120
1710.80.17.080.2	121
1710.80.17.100.1	120
1710.80.17.100.2	121

1  
2  
3  
4  
5  
6  
7  
8  
9  
10  
11  
12



Art.-Nr. Art. No.	Seite Page
1710.80.20.110.1	120
1710.80.20.110.2	120
1710.80.20.110.3	121
1710.80.20.110.4	121
1710.80.20.140.1	120
1710.80.20.140.2	120
1710.80.20.140.4	121
1710.80.21.160.1	122
1710.80.21.190.1	122
1710.80.25.160.1	120
1710.80.25.160.2	121
1710.80.25.190.1	120
1710.80.25.190.2	121
1710.80.29.230.1	122
1710.80.29.255.1	122
1710.80.32.210.1	120
1710.80.32.210.2	121
1710.80.32.250.1	120
1710.80.32.250.2	121
1710.80.36.305.1	122
1710.80.36.350.1	122
1710.80.40.285.1	120
1710.80.40.285.2	121
1710.80.40.320.1	120
1710.80.40.320.2	121
1710.80.42.370.1	122
1710.80.42.410.1	122
1710.80.48.430.1	122
1710.80.48.465.1	122
1710.80.50.370.1	120
1710.80.50.410.1	120
1710.80.63.460.1	120
1710.80.63.460.2	121
1710.80.63.500.1	120
1710.80.63.500.2	121
<b>20...</b>	
2010.111.007	80
2010.111.010	80
2010.111.013	80
2010.111.015	80
2010.111.017	80
2010.111.022	80
2010.111.029	80
2010.111.029	80
2010.111.038	80
2010.111.049	80
2010.112.007	80
2010.112.010	80
2010.112.013	80
2010.112.015	80
2010.112.017	80
2010.112.022	80
2010.112.029	80
2010.112.038	80
2010.112.049	80
2030.101.007	84
2030.101.010	84
2030.101.013	84
2030.101.015	84
2030.101.016	84
2030.101.021	84
2030.101.029	84
2030.101.038	84
2030.101.048	84
2040.701.007	85
2040.701.010	85
2040.701.013	85
2040.701.015	85

Art.-Nr. Art. No.	Seite Page
2040.701.016	85
2040.701.021	85
2040.701.029	85
2040.701.038	85
2040.701.048	85
2060.112.012	131
2060.112.016	131
2060.112.021	131
2060.112.026	131
2060.112.035	131
2080.111.010	132
2080.111.012	132
2080.111.016	132
2080.111.021	132
2080.111.026	132
2080.111.035	132
2080.111.050	132
<b>21...</b>	
2100.07.10.02	114
2100.09.14.02	114
2100.11.17.02	114
2100.12.10.02	114
2100.13.19.02	114
2100.16.21.02	114
2100.17.14.02	114
2100.20.17.02	114
2100.20.19.02	114
2100.21.27.02	114
2100.25.21.02	114
2100.29.36.02	114
2100.32.27.02	114
2100.36.45.02	114
2100.40.36.02	114
2100.48.56.02	114
2100.50.45.02	114
2100.63.56.02	114
2130.101.007	82
2130.101.011	82
2130.101.013	82
2130.101.017	82
2130.101.023	82
2130.101.029	82
2130.101.038	82
2130.101.049	82
2140.801.010	83
2140.801.012	83
2140.801.016	83
2140.801.022	83
2140.801.028	83
2140.801.037	83
2140.801.048	83
<b>22...</b>	
2210.711.007	81
2210.711.010	81
2210.711.013	81
2210.711.017	81
2210.711.022	81
2210.711.029	81
2210.711.038	81
2210.711.049	81
<b>24...</b>	
2410.17	158
2410.20	158
2410.25	158
2410.32	158
2410.40	158
2410.50	158

Art.-Nr. Art. No.	Seite Page
2445.12	154
2450.07.32	157
2450.07.34	156
2450.11.32	157
2450.11.34	156
2450.12.32	156
2450.12.34	156
2450.12.36	157
2450.17.32	156
2450.17.34	156
2450.17.36	157
2450.20.32	156
2450.20.34	156
2450.20.36	157
2455.12	154
<b>25...</b>	
2540.707.011	91
2540.707.013	91
2540.707.017	91
2540.707.023	91
2540.707.029	91
2540.707.038	91
2540.707.049	91
<b>26...</b>	
2600.10.10	113
2600.12.14	113
2600.17.17	113
2600.20.19	113
2600.20.21	113
2600.25.27	113
2600.32.36	113
2600.40.45	113
2600.50.56	113
<b>34...</b>	
3409.07	176
3411.07	176
3411.09	176
3413.09	176
3413.11	176
3416.09	176
3416.11	176
3416.13	176
3417.09	178
3420.11	178
3421.13	176
3421.16	176
3425.16	178
3429.21	176
3436.29	176
3440.29	178
3450.36	178
3455.09.12	179
3455.11.17	179
3455.13.17	179
3455.13.20	179
3455.16.20	179
3455.17.12	176
3455.20.12	176
3455.20.17	176
3455.21.25	179
3455.25.12	176
3455.25.17	176
3455.25.20	176
3455.29.32	179
3455.32.12	176
3455.32.17	176
3455.32.20	176

Art.-Nr. Art. No.	Seite Page
3455.32.25	176
3455.36.40	179
3455.40.17	176
3455.40.20	176
3455.40.25	176
3455.40.32	176
3455.50.20	176
3455.50.25	176
3455.50.32	176
3455.50.40	176
3455.63.25	176
3455.63.32	176
3455.63.40	176
3455.63.50	176
3463.48	178
<b>35...</b>	
3500.07.06	167
3500.07.08	167
3500.07.10	167
3500.08.06	162
3500.09.06	167
3500.09.08	167
3500.09.10	167
3500.09.12	167
3500.10.06	162
3500.10.08	162
3500.11.06	167
3500.11.08	167
3500.11.10	167
3500.11.12	167
3500.11.17	167
3500.12.08	162
3500.12.10	162
3500.13.12	167
3500.13.17	167
3500.16.12	167
3500.16.17	167
3500.16.20	167
3500.17.07	166
3500.17.10	162
3500.17.12	162
3500.20.07	166
3500.20.09	166
3500.20.11	166
3500.20.12	162
3500.20.17	162
3500.21.17	167
3500.21.20	167
3500.21.25	167
3500.25.09	166
3500.25.11	166
3500.25.13	166
3500.25.16	166
3500.25.17	162
3500.25.20	162
3500.29.25	167
3500.29.32	167
3500.32.20	162
3500.32.21	166
3500.32.25	162
3500.36.32	167
3500.36.40	167
3500.40.25	162
3500.40.29	166
3500.40.32	162
3500.42.32	167
3500.42.40	167

Art.-Nr. Art. No.	Seite Page
3500.42.50	167
3500.48.40	167
3500.48.50	167
3500.50.29	166
3500.50.32	162
3500.50.40	162
3500.63.36	166
3500.63.40	162
3500.63.50	162
3500.75.50	162
3500.75.63	162
3509.07	163
351/2G.09	169
351/2NPT.09	170
3511.07	163
3511.09	163
3511/4G.29	169
3513.07	163
3513.09	163
3513.11	163
35133/8G	169
3516.09	163
3516.11	163
3516.13	163
351G.21	169
351NPT.16	170
3521.11	163
3521.13	163
3521.16	163
3529.13	163
3529.16	163
3529.21	163
352G.36	169
352G.42	169
353/4G.09	169
353/4G.11	169
353/4G.16	169
353/4NPT.11	170
353/4NPT.13	170
353/8G.07	169
3536.21	163
3536.29	163
3542.29	163
3542.36	163
3545.11.17	168
3545.16.20	168
3545.17.12	163
3545.20.12	163
3545.20.17	163
3545.21.20	168
3545.21.25	168
3545.25.17	163
3545.25.20	163
3545.29.25	168
3545.29.32	168
3545.32.20	163
3545.32.25	163
3545.36.40	168
3545.40.25	163
3545.40.32	163
3545.50.32	163
3545.50.40	163
3545.63.40	163
3545.63.50	163
3548.48.36	163
<b>36...</b>	
3600.06.08	164

Art.-Nr. Art. No.	Seite Page
3600.06.10	164
3600.07.12	168
3600.07.17	168
3600.08.10	164
3600.08.12	164
3600.09.17	168
3600.09.20	168
3600.10.07	166
3600.10.09	166
3600.10.12	164
3600.10.17	164
3600.11.20	168
3600.11.25	168
3600.12.09	166
3600.12.17	164
3600.12.20	164
3600.13.20	168
3600.13.25	168
3600.16.25	168
3600.16.32	168
3600.17.11	166
3600.17.20	164
3600.20.13	166
3600.20.16	166
3600.20.25	164
3600.21.32	168
3600.21.40	168
3600.25.21	166
3600.25.32	164
3600.29.40	168
3600.29.50	168
3600.32.29	166
3600.32.40	164
3600.36.50	168
3600.36.63	168
3600.40.36	166
3600.40.50	164
3600.42.63	168
3600.42.75	168
3600.48.63	168
3600.48.75	168
3600.50.42	166
3600.50.48	166
3600.50.63	164
3600.63.75	164
3607.09.08	165
3609.11.08	165
3609.13.08	165
361/2G.11.08	170
361/2G.13.08	170
361/2G.16.08	170
361/2NPT.11	171
361/2NPT.13	171
361/2NPT.16	171
3611.13.08	165
3611.16.08	165
3611.21.08	165
3611/2G.36.08	170
3613.16.08	165
3613.21.08	165
3616.21.08	165
3616.29.08	165
36161/2G.08	169
361G.29.08	170
3621.29.08	165
36213/4G.08	169
3629.36.08	165

1  
2  
3  
4  
5  
6  
7  
8  
9  
10  
11  
12

Art.-Nr. Art. No.	Seite Page
363/4G.21.08	170
363/4NPT.21	171
363/8G.11.08	170
3636.42.08	165
3636.48.08	169
3636.48.48.08	165
3642.48.08	169
3645.07.12	169
3645.09.17	169
3645.11.20	169
3645.12.17	164
3645.13.20	169
3645.16.25	169
3645.17.20	164
3645.20.25	164
3645.21.32	169
3645.25.32	164
3645.29.40	169
3645.32.40	164
3645.40.50	164
3645.50.63	164
365/8G.16.08	170
367/8G.29.08	170
<b>37...</b>	
3707.09	177
3709.11	177
3711.13	177
3712.09	178
3713.16	177
3716.21	177
3720.13	178
3720.16	178
3721.29	177
3725.21	178
3729.36	177
3732.29	178
3736.42	177
3742.48	177
3750.42	178
3755.07.12	179
3755.07.17	179
3755.09.17	179
3755.09.20	179
3755.11.20	179
3755.12.17	177
3755.13.25	179
3755.16.25	179
3755.17.20	177
3755.20.25	177
3755.21.32	179
3755.25.32	177
3755.29.40	179
3755.32.40	177
3755.40.50	177
3755.42.50	179
3755.48.63	179
3755.50.63	177
<b>40...</b>	
4010.111.007	89/100
4010.111.010	89/100
4010.111.013	89/100
4010.111.015	89/100
4010.111.017	89/100
4010.111.022	89/100
4010.111.029	89/100
4010.111.038	89/100

Art.-Nr. Art. No.	Seite Page
4010.111.049	89/100
4051.701.008	145
4051.701.013	145
4051.701.017	145
4051.701.025	145
4051.701.040	145
4051.701.055	145
<b>41...</b>	
4110.701.007	90/102
4110.701.011	90/102
4110.701.013	90/102
4110.701.015	90/102
4110.701.017	90/102
4110.701.023	90/102
4110.701.029	90/102
4110.701.038	90/102
4110.701.049	90/102
<b>42...</b>	
4230.101.009	92
4230.101.012	92
4230.101.015	92
4230.101.020	92
4230.101.028	92
4230.101.037	92
4230.101.048	92
<b>50...</b>	
5000.07.10	126
5000.09.14	126
5000.11.17	126
5000.12.10	126
5000.13.19	126
5000.16.21	126
5000.17.14	126
5000.17.50	158
5000.20.17	126
5000.20.19	126
5000.20.50	158
5000.21.27	126
5000.25.21	126
5000.25.50	158
5000.29.36	126
5000.32.27	126
5000.32.50	158
5000.36.45	126
5000.40.36	126
5000.48.56	126
5000.50.45	126
5000.63.56	126
5010.031.016	60
5010.031.020	60
5010.031.025	60
5010.031.032	60
5010.031.040	60
5010.031.050	60
5010.031.063	60
5010.033.016	125
5010.033.020	125
5010.033.025	125
5010.033.032	125
5010.033.040	125
5010.033.050	125
5010.127.007	106
5010.127.009	106/107
5010.127.011	106
5010.127.013	106
5010.127.016	106
5010.127.021	106

Art.-Nr. Art. No.	Seite Page
5010.127.029	106
5010.127.036	106
5010.127.048	106
5010.128.007	107
5010.128.009	107
5010.128.011	107
5010.128.013	107
5010.128.016	107
5010.128.021	107
5010.128.029	107
5010.128.036	107
5010.128.048	107
5010.130.007	109
5010.130.009	109
5010.130.011	109
5010.130.013	109
5010.130.016	109
5010.130.021	109
5010.130.029	109
5010.130.036	109
5010.130.048	109
5010.135.016	108
5010.137.009	108
5010.137.011	108
5010.137.013	108
5010.137.029	108
5010.137.036	108
5010.137.048	108
5010.139.009	106
5010.139.021	106
5010.140.021	107
5010.301.025	108
5010.327.010	106
5010.327.012	106/107
5010.327.016	106
5010.327.020	106
5010.327.025	106
5010.327.032	106
5010.327.040	106
5010.327.050	106
5010.327.163	106
5010.328.010	107
5010.328.012	107
5010.328.016	107
5010.328.020	107
5010.328.025	107
5010.328.032	107
5010.328.040	107
5010.328.050	107
5010.328.163	107
5010.330.010	109
5010.330.012	109
5010.330.016	109
5010.330.020	109
5010.330.025	109
5010.330.032	109
5010.330.040	109
5010.330.050	109
5010.335.020	108
5010.337.012	108
5010.337.016	108
5010.337.032	108
5010.337.040	108
5010.337.050	108
5010.337.163	108
5010.339.012	106
5010.339.025	106

Art.-Nr. Art. No.	Seite Page
5010.340.025	107
5010.601.021	108
5011.127.009	110
5011.128.007	110
5011.128.009	110/112
5011.128.011	110
5011.128.013	110
5011.128.016	110
5011.128.021	110
5011.128.029	110/112
5011.128.036	110
5011.128.048	110
5011.135.011	112
5011.135.013	112
5011.135.016	112
5011.135.021	112
5011.135.036	112
5011.135.048	112
5011.140.021	110
5011.327.012	110
5011.328.010	110
5011.328.012	110/112
5011.328.016	110
5011.328.020	110
5011.328.025	110
5011.328.032	110/112
5011.328.040	110
5011.328.050	110
5011.335.016	112
5011.335.020	112
5011.335.025	112
5011.335.040	112
5011.335.050	112
5011.335.163	112
5011.340.025	110
5015.127.009	111
5015.128.011	111
5015.128.013	111
5015.128.016	111
5015.128.029	111
5015.128.036	111
5015.128.048	111
5015.140.021	111
5015.327.012	111
5015.328.016	111
5015.328.020	111
5015.328.032	111
5015.328.040	111
5015.328.050	111
5015.340.025	111
5020.006.211	72
5020.006.216	72
5020.006.217	72
5020.006.221	72
5020.008.201	73
5020.008.202	73
5020.008.204	72
5020.008.205	72
5020.008.208	73
5020.010.007	128
5020.010.009	128
5020.010.011	128
5020.010.013	128
5020.010.016	128
5020.010.021	128
5020.010.029	128
5020.010.036	128

Art.-Nr. Art. No.	Seite Page
5020.010.048	128
5020.014.012	128
5020.014.016	128
5020.014.020	128
5020.014.025	128
5020.014.032	128
5020.014.040	128
5020.014.050	128
5020.014.063	128
5020.020.216	73
5020.020.221	73
5020.020.229	73
5020.020.236	73
5020.020.248	73
5020.026.007	37
5020.026.009	37
5020.026.011	37
5020.026.013	37
5020.026.014	37
5020.026.016	37
5020.026.021	37
5020.026.029	37
5020.026.036	37
5020.026.048	37
5020.026.207	37
5020.026.209	37
5020.026.211	37
5020.026.213	37
5020.026.214	37
5020.026.216	37
5020.026.221	37
5020.026.229	37
5020.026.236	37
5020.026.248	37
5020.027.001E	38
5020.027.002R	38
5020.027.003R	38
5020.027.004R	38
5020.027.005R	38
5020.027.006R	38
5020.027.007R	38
5020.027.008E	38
5020.027.009E	38
5020.027.010E	38
5020.027.201E	38
5020.027.202R	38
5020.027.203R	38
5020.027.204R	38
5020.027.205R	38
5020.027.206R	38
5020.027.207R	38
5020.027.208E	38
5020.027.209E	38
5020.027.210E	38
5020.028.007	49
5020.028.009	49
5020.028.011	49
5020.028.013	49
5020.028.016	49
5020.028.021	49
5020.028.029	49
5020.028.036	49
5020.028.048	49
5020.028.207	49
5020.028.209	49
5020.028.211	49
5020.028.213	49

Art.-Nr. Art. No.	Seite Page
5020.028.216	49
5020.028.221	49
5020.028.229	49
5020.028.236	49
5020.028.248	49
5020.029.211	49
5020.029.213	49
5020.030.007	150
5020.030.009	150
5020.030.011	150
5020.030.013	150
5020.030.016	150
5020.030.021	150
5020.030.029	150
5020.030.036	150
5020.030.048	150
5020.031.012	44
5020.031.016	44
5020.031.020	44
5020.031.025	44
5020.031.032	44
5020.031.040	44
5020.031.050	44
5020.031.063	44
5020.031.212	44
5020.031.216	44
5020.031.220	44
5020.031.225	44
5020.031.232	44
5020.031.240	44
5020.031.250	44
5020.031.263	44
5020.032.203	62
5020.032.206	62
5020.032.208	62
5020.032.209	62
5020.032.210	62
5020.032.211	62
5020.033.205	63
5020.033.206	63
5020.033.207	63
5020.033.208	63
5020.033.209	63
5020.033.213	63
5020.034.007	45
5020.034.009	45
5020.034.011	45
5020.034.013	45
5020.034.014	45
5020.034.015	45
5020.034.016	45
5020.034.021	45
5020.034.029	45
5020.034.036	45
5020.034.048	45
5020.034.207	45
5020.034.209	45
5020.034.211	45
5020.034.213	45
5020.034.214	45
5020.034.215	45
5020.034.216	45
5020.034.221	45
5020.034.229	45
5020.034.236	45
5020.034.248	45
5020.036.016	48

1  
2  
3  
4  
5  
6  
7  
8  
9  
10  
11  
12

Art.-Nr. Art. No.	Seite Page	Art.-Nr. Art. No.	Seite Page	Art.-Nr. Art. No.	Seite Page
5020.036.020	48	5020.050.048	51	5020.055.245	39
5020.036.025	48	5020.050.207	51	5020.055.250	39
5020.036.032	48	5020.050.209	51	5020.055.263	39
5020.036.040	48	5020.050.211	51	5020.064.010	48
5020.036.050	48	5020.050.213	51	5020.064.012	48
5020.036.063	48	5020.050.216	51	5020.064.016	48
5020.036.216	48	5020.050.221	51	5020.064.020	48
5020.036.220	48	5020.050.229	51	5020.064.025	48
5020.036.225	48	5020.050.236	51	5020.064.032	48
5020.036.232	48	5020.050.248	51	5020.064.040	48
5020.036.240	48	5020.051.010	50	5020.064.050	48
5020.036.250	48	5020.051.012	50	5020.064.210	48
5020.036.263	48	5020.051.016	50	5020.064.212	48
5020.037.010	36	5020.051.018	50	5020.064.216	48
5020.037.012	36	5020.051.020	50	5020.064.220	48
5020.037.016	36	5020.051.022	50	5020.064.225	48
5020.037.020	36	5020.051.025	50	5020.064.232	48
5020.037.025	36	5020.051.028	50	5020.064.240	48
5020.037.032	36	5020.051.032	50	5020.064.250	48
5020.037.038	36	5020.051.034	50	5020.065.003	36
5020.037.040	36	5020.051.040	50	5020.065.005	36
5020.037.045	36	5020.051.042	50	5020.065.007	36
5020.037.050	36	5020.051.050	50	5020.065.009	36
5020.037.063	36	5020.051.054	50	5020.065.011	36
5020.037.210	36	5020.051.063	50	5020.065.203	36
5020.037.212	36	5020.051.210	50	5020.065.205	36
5020.037.216	36	5020.051.212	50	5020.065.207	36
5020.037.220	36	5020.051.216	50	5020.065.209	36
5020.037.225	36	5020.051.218	50	5020.065.211	36
5020.037.232	36	5020.051.220	50	5020.066.001	64
5020.037.238	36	5020.051.222	50	5020.066.002	64
5020.037.240	36	5020.051.225	50	5020.066.003	64
5020.037.245	36	5020.051.228	50	5020.066.004	64
5020.037.250	36	5020.051.232	50	5020.066.005	64
5020.037.263	36	5020.051.234	50	5020.066.007	64
5020.041.201	62	5020.051.240	50	5020.066.008	64
5020.041.202	62	5020.051.242	50	5020.066.009	64
5020.041.210	62	5020.051.250	50	5020.066.010	64
5020.041.211	62	5020.051.254	50	5020.066.201	64
5020.041.212	62	5020.051.263	50	5020.066.202	64
5020.041.213	62	5020.055.011	39	5020.066.203	64
5020.049.007	40	5020.055.012	39	5020.066.204	64
5020.049.009	40	5020.055.014	39	5020.066.205	64
5020.049.011	40	5020.055.016	39	5020.066.207	64
5020.049.013	40	5020.055.018	39	5020.066.208	64
5020.049.016	40	5020.055.020	39	5020.066.210	64
5020.049.021	40	5020.055.022	39	5020.071.025	60
5020.049.029	40	5020.055.025	39	5020.071.032	60
5020.049.036	40	5020.055.028	39	5020.071.040	60
5020.049.048	40	5020.055.032	39	5020.071.050	60
5020.049.207	40	5020.055.036	39	5020.071.063	60
5020.049.209	40	5020.055.040	39	5020.071.225	60
5020.049.211	40	5020.055.045	39	5020.071.232	60
5020.049.213	40	5020.055.050	39	5020.071.240	60
5020.049.216	40	5020.055.063	39	5020.071.250	60
5020.049.221	40	5020.055.211	39	5020.071.263	60
5020.049.229	40	5020.055.212	39	5020.074.207	41
5020.049.236	40	5020.055.214	39	5020.074.209	41
5020.049.248	40	5020.055.216	39	5020.074.211	41
5020.050.007	51	5020.055.218	39	5020.074.213	41
5020.050.009	51	5020.055.220	39	5020.074.216	41
5020.050.011	51	5020.055.222	39	5020.074.221	41
5020.050.013	51	5020.055.225	39	5020.074.229	41
5020.050.016	51	5020.055.228	39	5020.074.236	41
5020.050.021	51	5020.055.232	39	5020.074.248	41
5020.050.029	51	5020.055.236	39	5020.075.207	43
5020.050.036	51	5020.055.240	39	5020.075.209	43



Art.-Nr. Art. No.	Seite Page
5020.075.211	43
5020.075.213	43
5020.075.216	43
5020.075.221	43
5020.075.229	43
5020.075.236	43
5020.075.248	43
5020.077.021	52
5020.077.029	52
5020.077.036	52
5020.077.048	52
5020.077.221	52
5020.077.229	52
5020.077.236	52
5020.077.248	52
5020.078.014	42
5020.078.015	42
5020.078.016	42
5020.078.020	42
5020.078.025	42
5020.078.032	42
5020.078.040	42
5020.078.214	42
5020.078.215	42
5020.078.216	42
5020.078.220	42
5020.078.225	42
5020.078.232	42
5020.078.240	42
5020.079.214	42
5020.079.215	42
5020.079.216	42
5020.079.220	42
5020.079.225	42
5020.079.232	42
5020.079.240	42
5020.082.007	46
5020.082.009	46
5020.082.011	46
5020.082.016	46
5020.082.021	46
5020.082.029	46
5020.082.036	46
5020.082.207	46
5020.082.209	46
5020.082.211	46
5020.082.212	46
5020.082.216	46
5020.082.220	46
5020.082.221	46
5020.082.229	46
5020.082.236	46
5020.087.207	59
5020.087.209	59
5020.087.211	59
5020.087.213	59
5020.087.216	59
5020.087.221	59
5020.087.229	59
5020.087.236	59
5020.087.248	59
5020.088.207	55
5020.088.209	55
5020.088.211	55
5020.088.213	55
5020.088.216	55
5020.088.221	55

Art.-Nr. Art. No.	Seite Page
5020.088.229	55
5020.088.236	55
5020.088.248	55
5020.089.207	57
5020.089.209	57
5020.089.211	57
5020.089.213	57
5020.089.216	57
5020.089.221	57
5020.089.229	57
5020.089.236	57
5020.089.248	57
5020.090.207	53
5020.090.209	53
5020.090.211	53
5020.090.213	53
5020.090.216	53
5020.090.221	53
5020.090.229	53
5020.090.236	53
5020.090.248	53
5020.130.007	127
5020.130.009	127
5020.130.011	127
5020.130.013	127
5020.130.016	127
5020.130.021	127
5020.130.029	127
5020.130.036	127
5020.130.048	127
5020.330.010	127
5020.330.012	127
5020.330.016	127
5020.330.020	127
5020.330.025	127
5020.330.032	127
5020.330.040	127
5020.330.050	127
5020.382.216	46
5020.382.225	46
5020.382.250	46
5030.012.007	66
5030.012.009	66
5030.012.011	66
5030.012.013	66
5030.012.016	66
5030.012.021	66
5030.012.029	66
5030.012.036	66
5030.012.048	66
5030.012.207	66
5030.012.209	66
5030.012.211	66
5030.012.213	66
5030.012.216	66
5030.012.221	66
5030.012.229	66
5030.012.236	66
5030.012.248	66
5030.013.010	151
5030.013.014	151
5030.013.017	151
5030.013.021	151
5030.013.027	151
5030.013.036	151
5030.013.045	151
5030.013.056	151

Art.-Nr. Art. No.	Seite Page
5030.020.207	69
5030.020.209	69
5030.020.211	69
5030.020.213	69
5030.020.216	69
5030.020.221	69
5030.020.229	69
5030.020.236	69
5030.020.248	69
5030.021.011	65
5030.021.016	65
5030.021.021	65
5030.021.029	65
5030.021.209	65
5030.021.211	65
5030.021.216	65
5030.021.221	65
5030.021.229	65
5030.021.236	65
5030.021.248	65
5030.025.007	71
5030.025.009	71
5030.025.011	71
5030.025.013	71
5030.025.016	71
5030.025.021	71
5030.025.029	71
5030.025.036	71
5030.025.048	71
5030.025.207	31/70
5030.025.209	31/70
5030.025.211	31/70
5030.025.213	31/70
5030.025.216	31/70
5030.025.221	31/70
5030.025.229	31/70
5030.025.236	31/70
5030.025.248	31/70
5030.026.007	71
5030.026.009	71
5030.026.011	71
5030.026.013	71
5030.026.016	71
5030.026.021	71
5030.026.029	71
5030.026.036	71
5030.026.048	71
5030.026.207	31/70
5030.026.209	31/70
5030.026.211	31/70
5030.026.213	31/70
5030.026.216	31/70
5030.026.221	31/70
5030.026.229	31/70
5030.026.236	31/70
5030.026.248	31/70
5031.027.007	148
5031.027.009	148
5031.027.011	148
5031.027.013	148
5031.027.016	148
5031.027.021	148
5031.027.029	148
5031.027.036	148
5031.027.048	148
5031.028.007	148
5031.028.009	137/148/149

1  
2  
3  
4  
5  
6  
7  
8  
9  
10  
11

Art.-Nr. Art. No.	Seite Page	Art.-Nr. Art. No.	Seite Page	Art.-Nr. Art. No.	Seite Page
5031.028.011	148	5100.32.27	126	5103.054.250	53
5031.028.013	148	5100.40.36	126	5103.054.263	53
5031.028.016	148	5100.50.45	126	5104.010.012	54
5031.028.021	148	5100.63.56	126	5104.010.212	54
5031.028.029	148/149	5101.010.012	58	5104.013.016	54
5031.028.036	148	5101.010.212	58	5104.013.216	54
5031.028.048	148	5101.013.016	58	5104.015.020	54
5031.034.007	151	5101.013.216	58	5104.015.220	54
5031.034.009	151	5101.015.020	58	5104.021.020	54
5031.034.011	151	5101.015.220	58	5104.021.025	54
5031.034.013	151	5101.021.020	58	5104.021.220	54
5031.034.016	151	5101.021.025	58	5104.021.225	54
5031.034.021	151	5101.021.220	58	5104.028.025	54
5031.034.029	151	5101.021.225	58	5104.028.032	54
5031.034.036	151	5101.028.025	58	5104.028.225	54
5031.034.048	151	5101.028.032	58	5104.028.232	54
5031.035.011	149	5101.028.225	58	5104.034.032	54
5031.035.013	149	5101.028.232	58	5104.034.040	54
5031.035.016	149	5101.034.032	58	5104.034.232	54
5031.035.021	149	5101.034.040	58	5104.034.240	54
5031.035.036	149	5101.034.232	58	5104.042.040	54
5031.035.048	149	5101.034.240	58	5104.042.050	54
5031.037.009	149	5101.042.040	58	5104.042.240	54
5031.037.011	149	5101.042.050	58	5104.042.250	54
5031.037.029	149	5101.042.240	58	5104.054.050	54
5031.037.036	149	5101.042.250	58	5104.054.063	54
5031.037.048	149	5101.054.050	58	5104.054.250	54
5031.039.009	148	5101.054.063	58	5104.054.263	54
5031.039.021	148	5101.054.250	58	5105.010.212	55
5031.040.021	148	5101.054.263	58	5105.013.216	55
5032.006.070	27	5102.010.212	59	5105.015.220	55
5032.006.095	27	5102.013.216	59	5105.021.220	55
5032.007.070	27	5102.015.220	59	5105.021.225	55
5032.007.095	27	5102.021.220	59	5105.028.225	55
5032.206.070	27	5102.021.225	59	5105.028.232	55
5032.206.095	27	5102.028.225	59	5105.034.232	55
5032.207.070	27	5102.028.232	59	5105.034.240	55
5032.207.095	27	5102.034.232	59	5105.042.240	55
5032.211.070	27	5102.034.240	59	5105.042.250	55
5032.211.095	27	5102.042.240	59	5105.054.250	55
<b>51...</b>		5102.042.250	59	5105.054.263	55
5100.010.212	57	5102.054.250	59	5107.010.212	41
5100.013.216	57	5102.054.263	59	5107.013.216	41
5100.015.020	57	5103.010.012	53	5107.015.216	41
5100.015.220	57	5103.010.212	53	5107.015.220	41
5100.021.020	57	5103.013.016	53	5107.021.220	41
5100.021.025	57	5103.013.216	53	5107.021.225	41
5100.021.220	57	5103.015.020	53	5107.028.225	41
5100.021.225	57	5103.015.220	53	5107.028.232	41
5100.028.032	57	5103.021.020	53	5107.034.232	41
5100.028.225	57	5103.021.025	53	5107.034.240	41
5100.028.232	57	5103.021.220	53	5107.042.240	41
5100.034.040	57	5103.021.225	53	5107.042.250	41
5100.034.232	57	5103.028.025	53	5107.054.250	41
5100.034.240	57	5103.028.032	53	5107.054.263	41
5100.042.040	57	5103.028.225	53	5108.010.212	43
5100.042.050	57	5103.028.232	53	5108.013.216	43
5100.042.240	57	5103.034.032	53	5108.015.220	43
5100.042.250	57	5103.034.040	53	5108.021.220	43
5100.054.063	57	5103.034.232	53	5108.021.225	43
5100.054.250	57	5103.034.240	53	5108.028.225	43
5100.054.263	57	5103.042.040	53	5108.034.232	43
5100.12.10	126	5103.042.050	53	5108.042.240	43
5100.17.14	126	5103.042.240	53	5108.054.250	43
5100.20.17	126	5103.042.250	53	5131.021.220	56
5100.20.19	126	5103.054.050	53	5131.028.225	56
5100.25.21	126	5103.054.063	53	5131.034.232	56

Art.-Nr. Art. No.	Seite Page
5131.042.240	56
5128.015.216	30
5128.015.220	30
5128.021.220	30
5128.021.225	30
5128.028.225	30
5128.028.232	30
5128.034.232	30
5128.034.240	30
5128.042.240	30
5128.042.250	30
5128.054.250	30
5128.054.263	30
5131.021.220	56
5131.028.225	56
5131.034.232	56
5131.042.240	56
<b>55...</b>	
5524.021.200	74
5524.028.200	74
5524.034.200	74
5524.042.200	74
5524.054.200	74
5524.067.200	74
5524.079.200	74
<b>56...</b>	
5601.015.221	63
5601.015.228	63
5601.015.234	63
5601.021.228	63
5601.021.234	63
5601.021.254	63
5601.028.234	63
5601.034.242	63
5601.042.254	63
5602.021.221	64
5602.028.228	64
5602.034.234	64
5602.042.242	64
5602.054.254	64
5604.015.016	47
5604.015.216	47
5604.021.020	47
5604.021.220	47
5604.028.025	47
5604.028.225	47
5604.034.032	47
5604.034.232	47
5604.042.040	47
5604.042.240	47
5604.054.050	47
5604.054.250	47
5605.042.215	74
5605.042.221	74
5605.042.228	74
5605.042.234	74
5606.015.207	75
5606.021.210	75
5606.028.210	75
5606.028.214	75
5606.028.216	75
5606.028.219	75
5606.042.218	75
5606.042.222	75
5606.042.226	75
5606.042.230	75
5606.054.234	75

Art.-Nr. Art. No.	Seite Page
5606.054.240	75
5606.054.242	75
5609.042.242	26
5609.054.254	26
5607.028.234	75
5607.034.242	75
5607.042.254	75
<b>68...</b>	
6850.40.03	144
6850.40.04	144
6850.40.05	144
6850.40.06	144
6850.40.08	144
6850.40.10	144
6850.40.12	144
6850.40.14	144
6850.40.16	144
6850.40.18	144
6850.40.20	144
6850.40.22	144
6850.40.24	144
6850.40.25	144
6850.40.30	144
6850.40.35	144
6850.40.40	144
6850.40.45	144
6850.40.50	144
6850.40.70	144
6875.40.03	143
6875.40.04	143
6875.40.05	143
6875.40.05.10	143
6875.40.08	143
6875.40.10	143
6875.40.10.10	143
6875.40.15	143
6875.40.18.06	143
6875.40.20	143
6875.40.24	143
6875.40.30.06	143
6875.40.36	143
6875.40.50	143
6875.70.03	143
6875.70.04	143
6875.70.05	143
6875.70.08	143
6875.70.10	143
6875.70.15	143
6875.70.20	143
6875.70.24	143
6875.70.36	143
6875.70.50	143
6878.40.06	28/145
6878.40.09	28/145
6878.40.13	28/145
6878.40.19	28/145
6878.40.25	28/145
6878.40.32	28/145
6878.40.38	28/145
6878.40.50	28/145
<b>80...</b>	
8000.06	159
8000.06.1	159
8000.08	159
8000.08.1	159
8000.080	159
8000.085	159

Art.-Nr. Art. No.	Seite Page
8000.095	159
8000.10	159
8000.10.1	159
8000.100	159
8000.105	159
8000.115	159
8000.12	159
8000.17	159
8000.20	159
8000.25	159
8000.32	159
8000.40	159
8000.50	159
8000.63	159
8000.75	159
8007	159
8009	159
801/2G	160
8011	159
8011/2G	160
8011/4G	160
8013	159
8016	159
801G	160
8021	159
8029	159
803/4G	160
803/8G	160
8036	159
8042	159
8048	160
8048.48	159
805/8G	160
8050	160
8051	160
<b>82...</b>	
8207	174
8207.40	174
8209	174
8209.40	174
8211	174
8211.40	174
8212	174
8212.40	174
8213	174
8213.40	174
8216	174
8216.40	174
8217	174
8217.40	174
8220	174
8220.40	174
8221	174
8221.40	174
8225	174
8225.40	174
8229	174
8229.40	174
8232	174
8232.40	174
8236	174
8236.40	174
8240	174
8240.40	174
8242	174
8242.40	174
8245.07	175

1  
2  
3  
4  
5  
6  
7  
8  
9  
10  
11  
12

Art.-Nr. Art. No.	Seite Page
8245.09	175
8245.11	175
8245.12	175
8245.13	175
8245.16	175
8245.17	175
8245.20	175
8245.21	175
8245.25	175
8245.29	175
8245.32	175
8245.36	175
8245.40	175
8245.42	175
8245.48	175
8245.50	175
8245.63	175
8248.48	174
8248.48.40	174
8250	174
8250.40	174
8255.07	175
8255.09	175
8255.11	175
8255.12	175
8255.13	175
8255.16	175
8255.17	175
8255.20	175
8255.21	175
8255.25	175
8255.29	175
8255.32	175
8255.36	175
8255.40	175
8255.42	175
8255.48	175
8255.50	175
8255.63	175
<b>83...</b>	
8300.07	160
8300.09	160
8300.11	160
8300.12	160
8300.12.1	161
8300.13	160
8300.16	160
8300.17	160
8300.17.1	161
8300.20	160
8300.20.1	161
8300.21	160
8300.25	160
8300.25.1	161
8300.29	160
8300.32	160
8300.32.1	161
8300.40	160
8300.40.1	161
8300.50.1	161
8300.63.1	161
8324.12	157
8324.17	157
8324.20	157
<b>87...</b>	
8706.08	172
8706.11.08	172

Art.-Nr. Art. No.	Seite Page
8707.08	173
8707.11.08	173
8708.08	172
8708.11.08	172
8709.08	173
8709.11.08	173
8710.08	172
8710.11.08	172
8711.08	173
8711.11.08	173
8712.08	172
8712.11.08	172
8713.08	173
8713.11.08	173
8716.08	173
8716.11.08	173
8717.08	172
8717.11.08	172
8720.08	172
8720.11.08	172
8721.08	173
8721.11.08	173
8725.08	172
8725.11.08	172
8729.08	173
8729.11.08	173
8732.08	172
8732.11.08	172
8736.08	173
8736.11.08	173
8740.08	172
8740.11.08	172
8742.08	173
8745.12	173
8745.17	173
8745.20	173
8745.25	173
8745.32	173
8745.40	173
8745.50	173
8745.63	173
8748.08	173
8748.11.08	173
8748.48.08	173
8750.08	172
8750.11.08	172
8763.08	172
8763.11.08	172
8775.08	172
8775.11.08	172
<b>88...</b>	
8807	180
8809	180
8811	180
8813	180
8816	180
8821	180
8829	180
8836	180
8842	180
8845.12	180
8845.17	180
8845.20	180
8845.25	180
8845.32	180
8845.40	180
8845.50	180

Art.-Nr. Art. No.	Seite Page
8845.63	180
8848.48	180
8855.12	180
8855.17	180
8855.20	180
8855.25	180
8855.32	180
8855.40	180
8855.50	180
8855.63	180
<b>EX...</b>	
EX1700.12.10.065	98
EX1700.17.14.060	98
EX1700.17.14.080	98
EX1700.17.14.105	98
EX1700.20.17.080	98
EX1700.20.17.110	98
EX1700.20.19.080	98
EX1700.20.19.110	98
EX1700.20.19.150	98
EX1700.20.21.080	98
EX1700.20.21.110	98
EX1700.20.21.150	98
EX1700.25.21.125	98
EX1700.25.21.160	98
EX1700.25.27.125	98
EX1700.25.27.160	98
EX1700.25.27.205	98
EX1700.32.27.210	98
EX1700.40.36.285	98
EX1700.50.45.370	98
EX1700.63.56.460	98
EX2450.12.34	155
EX2450.17.34	155
EX2450.20.34	155
EX1700.50.45.370	98
EX1700.63.56.460	98
EX2450.12.34	155
EX2450.17.34	155
EX2450.20.34	155
<b>EX...</b>	
EX1700.12.10.065	102
EX1700.17.14.060	102
EX1700.17.14.080	102
EX1700.17.14.105	102
EX1700.20.17.080	102
EX1700.20.17.110	102
EX1700.20.19.080	102
EX1700.20.19.110	102
EX1700.20.19.150	102
EX1700.20.21.080	102
EX1700.20.21.110	102
EX1700.20.21.150	102
EX1700.25.21.125	102
EX1700.25.21.160	102
EX1700.25.27.125	102
EX1700.25.27.160	102
EX1700.25.27.205	102
EX1700.32.27.210	102
EX1700.40.36.285	102
EX1700.50.45.370	102
EX1700.63.56.460	102

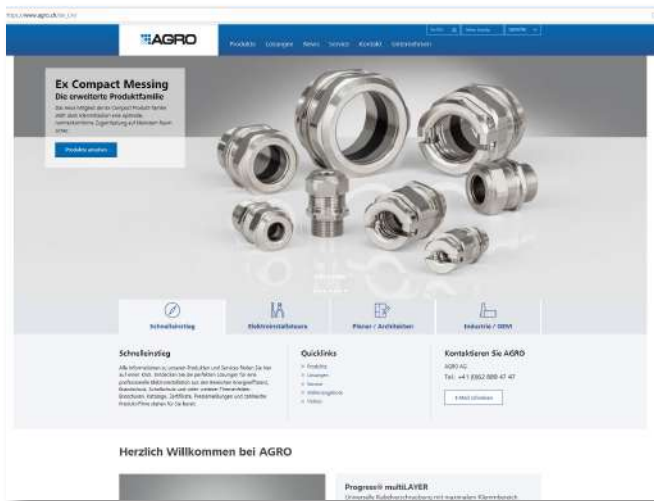

Alle weiterführenden Informationen zu Produkten, Systemlösungen und Kommunikationsmedien finden Sie aktuell auf unserer Internetseite [www.agro.ch](http://www.agro.ch).

Please find additional information about products, system solutions and communication media on our website [www.agro.ch](http://www.agro.ch).



[www.agro.ch](http://www.agro.ch)



[www.agro.ch](http://www.agro.ch)

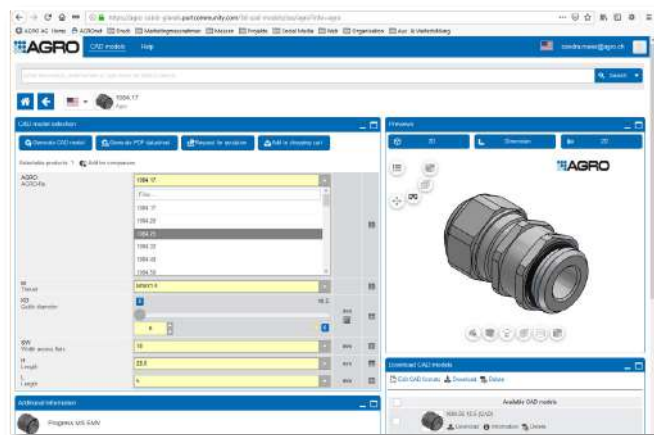

### CAD-Daten in allen gängigen Formaten.

Von nahezu allen Kabelverschraubungen kann die 3D-Produktansicht eingeblendet werden. Hier bieten wir Ihnen den besonderen Service, die jeweiligen Daten in allen gängigen CAD-Formaten sich per Email zusenden zu lassen.

Die 3D-Ansicht und die Bestellmöglichkeit für die CAD-Daten können Sie über den Navigationspunkt „CAD Ansicht“ in der Produkt-Einzelansicht im Navigationsmenü unter den Produktdaten aufrufen.

### CAD-data in all current formats.

For almost all cable glands, a 3D view can be displayed. 3D CAD data may be requested and will be sent via email in all current formats.

You have the possibility to display a 3D view or to order CAD data when you choose a specific item and click on the navigation bar „CAD view“. You will find this bar at the bottom of the product specifications.



# Systeme und Lösungen

für die professionelle Elektro-Installation.

# Systems and solutions

for the professional electrical installation.



Elektro-Installation  
Electrical installation



Kabelverschraubungen  
Cable glands



Kabelschutzschläuche  
Protective cable conduits



Abschottungs-Systeme  
Sealing systems



Explosionsschutz  
Explosion protection



Brandschutz  
Fire protection



Schallschutz  
Sound insulation



EMV  
EMC

Alle weiterführenden Informationen zu Produkten, Lösungen und Kommunikationsmedien finden Sie auf: [www.agro.ch](http://www.agro.ch).

Please find additional information about products, system solutions and communication media on: [www.agro.ch](http://www.agro.ch).