

### Main Features

- For corrosive gasses and liquids
- Isolating, purging and calibration of measuring instruments
- For pressure gauges, pressure switches and transmitters
- Gauge, absolute and differential pressure
- Full stainless steel
- Option: NACE conform

### Applications

- Oil & Gas / Chemical
- Water & Waste water
- Energy
- Machinery

### Description

AMFD manifolds make it possible to close off, purge or isolate measurement pipework. They offer the opportunity to check pressure measuring instruments or transmitters by isolating them (e.g. for zero adjustment).

For all of our manifolds the heads can be changed without the need for special tools. The valve stem is fitted with a rear seat. Thus the pressure load on the gland packing is relieved when the stem is opened to its limit stop.

All of our manifolds are suitable for liquids and gases and are subjected to an overpressure strength test during manufacture (1.5 times the rated pressure).

Connections	Inlet:	1/2 NPT female
	Outlet:	1/2 NPT female
	Purge/test:	1/4 NPT female with plug (only 2-way and 5-way)
Components	Body:	1.4404 (316L)
	Bonnet:	1.4401 (316)
	Valve stem:	1.4404 (316L) <sup>(1)</sup>
	Needle tip:	1.4571 (316Ti)
	Packing:	PTFE (up to 200 °C)
	Gland nut:	1.4301 (304)
	T-Handle:	Stainless Steel
Screw plug:	1.4404 (316L)	

<sup>(1)</sup> External stem thread

Stem with cold rolled surface, back seat and non-rotating needle tip

### Pressure / Temperature diagram

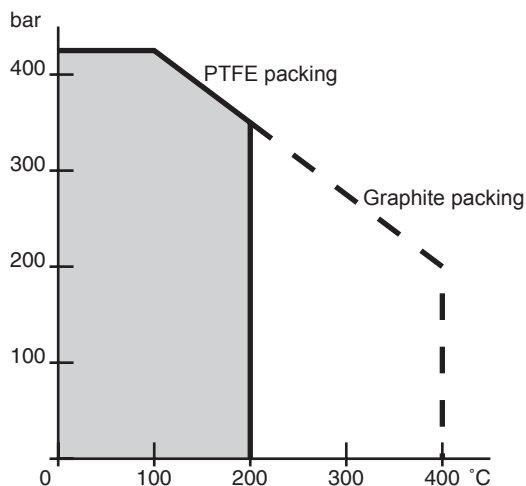

### Options

Compliant with NACE MR0175 and MR0103	Code 0073
Mounting kit on 2" pipes	Code 0407
Degreased for oxygen applications	Code 0765
Packing graphite ( $\leq 400$ °C)	Code 1803
Material certificate 3.1	Code Q003

## Dimensions

**Manifold 2 ways**

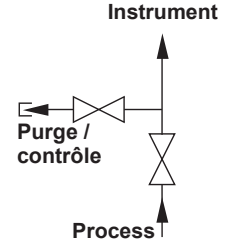
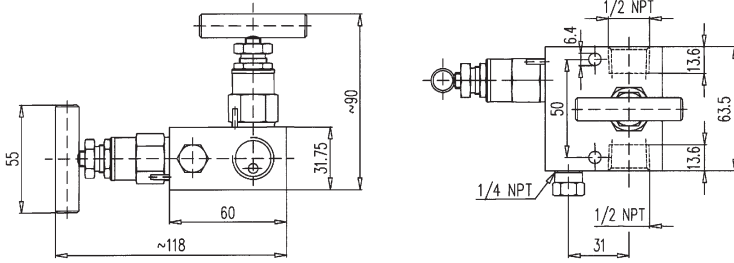

**Manifold 3 ways**

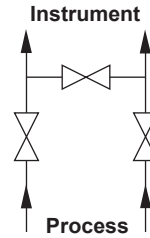
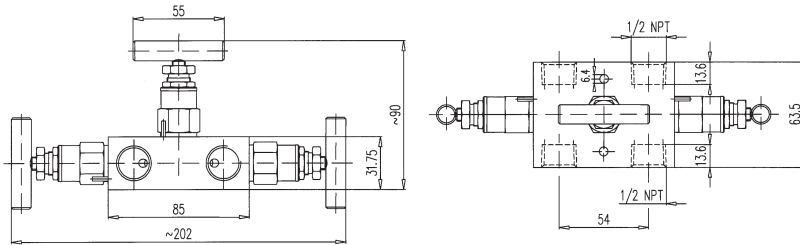

**Manifold 5 ways**

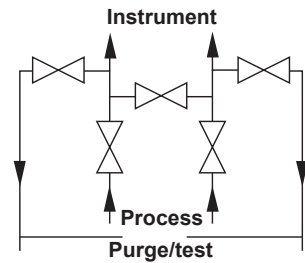
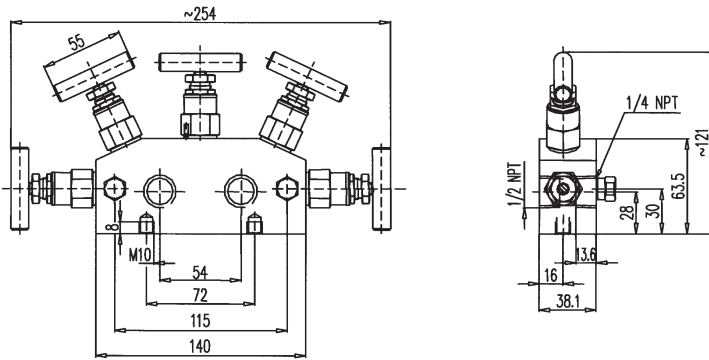

## Ordering details

		.	xxx	.	xx	.	x
<b>Model</b>							
Accessories	A						
<b>Type</b>							
Manifold	MFD						
<b>Operation</b>							
2 ways							02
3 ways							03
5 ways							05
<b>Inlet / Outlet thread</b>							
1/2 NPT female							N