

US-M | metric thread

Connectors

Metal connector, safety-type, straight, metric outer thread, incl. ferrule [brass | plastics], brass thrust collar and O-ring [NBR]

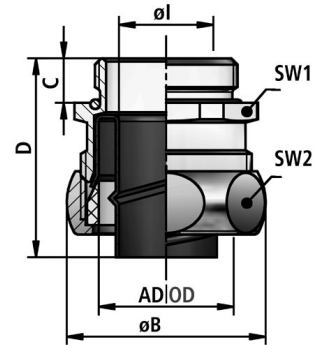

Temperature: -40°C ... +250°C

Material: nickel-plated brass

Protection class [acc. to EN 60529]: IP4



FLEXA No.	OD [mm]	Thread type	Conduit DI	Conduit OD	Ø I [mm]	Ø B [mm]	C [mm]	D [mm]	WS1 [mm]	WS2 [mm]	Weight [kg/100]	PU [pcs.]
15011328012	14,0	M12 x 1,5	10,0	14,0	8,5	23,0	10,0	33,0	19	21	2,140	50
15011335016	17,0	M16 x 1,5	12,0	17,0	11,0	27,0	10,0	33,0	23	25	3,000	50
15011335020	21,0	M20 x 1,5	16,0	21,0	14,5	31,0	10,0	33,0	27	29	3,940	50
15011335025	27,0	M25 x 1,5	20,0	27,0	19,5	39,0	11,0	41,0	34	36	7,500	25
15011328032	36,0	M32 x 1,5	29,0	36,0	27,5	48,0	14,0	43,0	43	45	11,300	25
15011335040	45,0	M40 x 1,5	37,0	45,0	35,0	57,0	13,0	43,0	52	54	15,000	20
15011335050	56,0	M50 x 1,5	48,0	56,0	45,0	70,0	15,5	49,0	63	66	21,800	10
15011335163	56,0	M63 x 1,5	48,0	56,0	47,0	74,0	14,0	49,0	70	70	27,100	10

Recommendations for any areas of applications, products, or product combinations are issued to the best of FLEXA's knowledge and experience. The user is requested to check applicability of FLEXA products to specific applications and purposes prior to the use of the particular products. All documentation, illustrations, and charts published are subject to copyright and must not be copied, changed, used, or modified. Technical drawings, certificates, authorizations, and results by the FLEXA lab will be provided upon request. FLEXA will not be held liable for typographical or other errors and incorrect drawings. Technical modifications are subject to change without prior notice.