

US-P | PG thread

Metal connector, safety-type, straight, PG outer thread, incl. ferrule [brass | plastics], sealing [TPE] and O-ring [NBR]

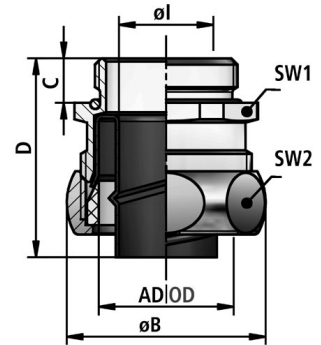

Temperature: -40°C ... +125°C

Material: nickel-plated brass

Protection class [acc. to EN 60529]: IP5



FLEXA No.	OD [mm]	Thread type	Conduit DI	Conduit OD	ø 1 [mm]	ø B [mm]	C [mm]	D [mm]	WS1 [mm]	WS2 [mm]	Weight [kg/100]	PU [pcs.]
15010128007	10,0	PG7	7,0	10,0	6,0	19,0	7,0	28,0	15	17	1,420	50
15010128009	14,0	PG9	10,0	14,0	8,5	23,0	7,0	30,0	19	21	2,140	50
15010128011	17,0	PG11	13,0	17,0	11,5	27,0	7,0	30,0	23	25	3,000	50
15010128013	19,0	PG13,5	15,0	19,0	13,5	29,0	7,0	30,0	25	27	3,370	50
15010128016	21,0	PG16	17,0	21,0	15,5	31,0	7,0	30,0	27	29	3,700	50
15010128021	27,0	PG21	22,0	27,0	20,5	39,0	10,0	40,0	34	36	7,350	25
15010128029	36,0	PG29	29,0	36,0	27,5	48,0	10,0	40,0	43	45	10,300	25
15010128036	45,0	PG36	38,0	45,0	36,5	57,0	10,0	40,0	52	54	13,400	20
15010128048	56,0	PG48	49,0	56,0	47,5	70,0	10,0	45,0	63	66	19,130	10
15010428007	10,0	PG7	7,0	10,0	6,0	19,0	7,0	28,0	15	17	1,420	10
15010428009	14,0	PG9	10,0	14,0	8,5	23,0	7,0	30,0	19	21	2,300	10
15010428011	17,0	PG11	13,0	17,0	11,5	27,0	7,0	30,0	23	25	3,000	10
15010428013	19,0	PG13,5	15,0	19,0	13,5	29,0	7,0	30,0	25	27	3,370	10
15010428016	21,0	PG16	17,0	21,0	15,5	31,0	7,0	30,0	27	29	3,700	10
15010428021	27,0	PG21	22,0	27,0	20,5	39,0	10,0	40,0	34	36	7,350	10
15010428029	36,0	PG29	29,0	36,0	27,5	48,0	10,0	40,0	43	45	10,300	2
15010428036	45,0	PG36	38,0	45,0	36,5	57,0	10,0	40,0	52	54	13,400	2
15010428048	56,0	PG48	49,0	56,0	47,5	70,0	10,0	45,0	63	66	19,130	2

Recommendations for any areas of applications, products, or product combinations are issued to the best of FLEXA's knowledge and experience. The user is requested to check applicability of FLEXA products to specific applications and purposes prior to the use of the particular products. All documentation, illustrations, and charts published are subject to copyright and must not be copied, changed, used, or modified. Technical drawings, certificates, authorizations, and results by the FLEXA lab will be provided upon request. FLEXA will not be held liable for typographical or other errors and incorrect drawings. Technical modifications are subject to change without prior notice.