

US2-M | metric thread**Connectors**

Metal connector, safety-type, straight, metric inner thread, incl. ferrule [brass] and sealing [TPE]

Temperature: -40°C ... +125°C

Material: nickel-plated brass

Protection class [acc. to EN 60529]: IP00

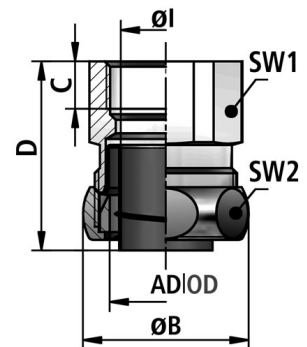

FLEXA No.	OD [mm]	Thread type	Conduit DI	Conduit OD	Ø1 [mm]	ØB [mm]	C [mm]	D [mm]	WS1 [mm]	WS2 [mm]	Weight [kg/100]	PU [pcs.]
15012327010	10,0	M 10 x 1,0	8,0	10,0	7,5	19,0	8,0	26,0	15	17	1,500	25
15012327012	14,0	M12 x 1,5	11,0	14,0	7,5	23,0	8,0	27,0	21	21	2,300	25
15012327016	17,0	M16 x 1,5	14,0	17,0	11,0	27,0	8,0	27,0	24	25	3,000	25
15012327020	21,0	M20 x 1,5	18,0	21,0	14,5	31,0	10,0	30,0	30	29	4,000	25
15012327025	27,0	M25 x 1,5	23,0	27,0	19,5	39,0	11,0	37,0	36	36	7,600	10
15012327032	36,0	M32 x 1,5	31,0	36,0	27,5	48,0	11,0	39,0	46	45	10,100	10
15012327040	45,0	M40 x 1,5	40,0	45,0	35,5	57,0	12,0	42,0	55	54	13,500	5
15012327050	56,0	M50 x 1,5	51,0	56,0	47,0	70,0	12,0	46,0	65	66	20,000	5

Recommendations for any areas of applications, products, or product combinations are issued to the best of FLEXA's knowledge and experience. The user is requested to check applicability of FLEXA products to specific applications and purposes prior to the use of the particular products. All documentation, illustrations, and charts published are subject to copyright and must not be copied, changed, used, or modified. Technical drawings, certificates, authorizations, and results by the FLEXA lab will be provided upon request. FLEXA will not be held liable for typographical or other errors and incorrect drawings. Technical modifications are subject to change without prior notice.